



US00D986006S

(12) **United States Design Patent** (10) **Patent No.:** **US D986,006 S**  
**Kemelman et al.** (45) **Date of Patent:** **\*\* May 16, 2023**

(54) **FOOD HOLDER**

(71) Applicants: **Ariel Kemelman**, Hoboken, NJ (US);  
**Kiley Kemelman**, Hoboken, NJ (US)  
(72) Inventors: **Ariel Kemelman**, Hoboken, NJ (US);  
**Kiley Kemelman**, Hoboken, NJ (US)

(\*\*) Term: **15 Years**

(21) Appl. No.: **29/781,071**

(22) Filed: **Apr. 28, 2021**

(51) **LOC (14) Cl.** ..... **07-01**

(52) **U.S. Cl.**

USPC ..... **D7/504**

(58) **Field of Classification Search**

USPC ..... D3/229, 273, 274, 276, 283, 287, 288,  
D3/289, 292, 294, 299, 300, 301, 303,  
D3/305, 306, 310, 313, 315-316;  
D4/120, 128, 134-136; D7/372, 383,  
D7/393-395, 396.2, 400, 401.2, 504, 507,  
D7/523, 533, 541-549, 550.1, 551.1,  
D7/551.2, 553.1, 601, 602, 605, 607, 611,  
D7/612, 614, 619.1, 619.2, 620, 622,  
D7/624.1-624.3, 629, 635, 637, 638,  
D7/641-645, 647-649, 625, 662, 669,  
D7/682, 675, 701, 702, 703, 704, 705,  
D7/708, 708.1, 709, 691; D9/430, 761,  
D9/702-704, 710, 721, 740, 741, 743,  
D9/744, 745, 759, 762; D26/9, 11, 22  
CPC ..... A22C 7/00; A45C 11/20; A45C 11/26;  
A45C 2200/20; A45C 2200/05; A45F  
2200/0583; A45F 2003/002; A45F 3/02;  
A45F 3/16; A45F 4/02; A45F 4/00; A45F  
5/10; A45F 5/102; A45F 5/00; A47B  
73/00;

(Continued)

(56) **References Cited**

**U.S. PATENT DOCUMENTS**

2,180,540 A \* 11/1939 Moebus ..... A47G 21/001  
294/143  
D232,013 S \* 7/1974 Gunner ..... D7/691

(Continued)

**OTHER PUBLICATIONS**

Burrito Pop, posted Apr. 6, 2021 [online], [retrieved Oct. 5, 2022].  
Retrieved from internet, <https://www.amazon.com/Burrito-Pop/dp/B091NHTL5S/> (Year: 2021).\*

(Continued)

*Primary Examiner* — Nicole C Shiflet

*Assistant Examiner* — Yen Le Southwood

(74) *Attorney, Agent, or Firm* — Walter J. Tencza, Jr.

(57) **CLAIM**

We claim the ornamental design for a food holder, as shown and described.

**DESCRIPTION**

FIG. 1 is a perspective view of the food holder in a rolled state wrapped around a bottom of a rolled tortilla of a burrito, with a filling shown within the rolled tortilla;

FIG. 2 is a top, front, and right side perspective view of the food holder in an unrolled, flat state;

FIG. 3 is a bottom, rear and left side perspective view of the food holder in the unrolled, flat state;

FIG. 4 is a top plan view of the food holder in the unrolled, flat state;

FIG. 5 is a bottom plan view of the food holder in the unrolled, flat state;

FIG. 6 is a rear elevational view of the food holder in the unrolled, flat state;

FIG. 7 is a front elevational view of the food holder in the unrolled, flat state;

FIG. 8 is a left side elevational view of the food holder in the unrolled, flat state; and,

FIG. 9 is a right side elevational view of the food holder in the unrolled, flat state.

The broken lines depicting the burrito form no part of the claimed design.

**1 Claim, 8 Drawing Sheets**

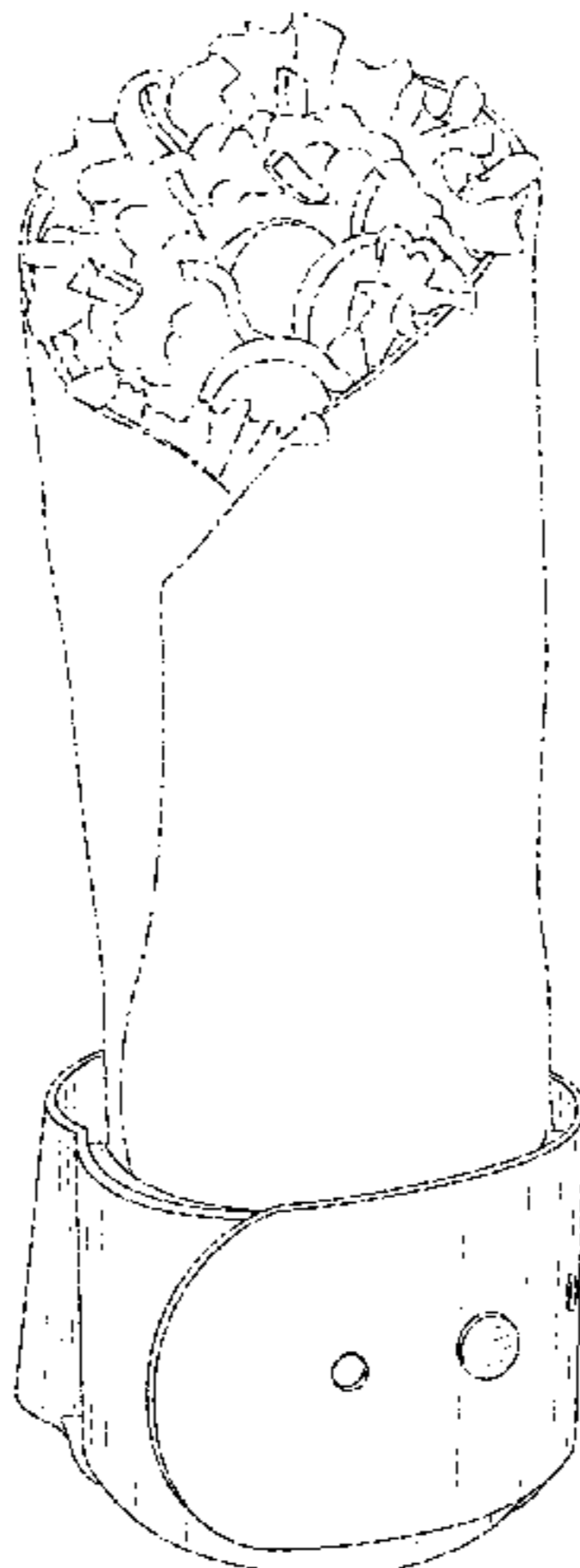

(58) **Field of Classification Search**

CPC ... A47G 19/2205; A47G 19/30; A47G 23/02;  
 A47G 23/0208; A47G 23/0216; A47G  
 23/0233; A47G 23/0241; A47G 23/0266;  
 A47G 23/0625; A47G 23/0641; A47G  
 23/065; A47G 21/001; A47J 29/06; A47J  
 29/00; A47J 29/02; A47J 29/04; A47J  
 42/50; A47J 43/28; A47J 43/00; A47J  
 43/20; A47J 45/00; A47J 45/06; A47J  
 45/066; A47J 45/077; A47J 45/07; A47J  
 45/10; A47J 47/02; A47J 47/06; A47J  
 47/08; A47J 47/14; B65D 23/3102; B65D  
 25/10; B65D 25/28; B65D 25/2817;  
 B65D 25/2829; B65D 25/2832; B65D  
 25/2879; G65D 51/24; B24D 15/04

See application file for complete search history.

(56) **References Cited**

U.S. PATENT DOCUMENTS

D236,066	S *	7/1975	Best	.....	D7/691
4,157,166	A *	6/1979	Voelker	.....	A45F 5/00 224/555
4,608,259	A	8/1986	Cortopassi		
D319,372	S *	8/1991	Cobb		
7,004,377	B2	2/2006	Metcalf		
7,862,095	B2	1/2011	Rodriguez		
7,971,748	B2	7/2011	Lion		
9,220,278	B2	12/2015	Alley		
D889,919	S *	7/2020	Chapman	.....	D7/691
D901,984	S	11/2020	Lakatos		
D908,437	S	1/2021	Alanis		
10,888,974	B1 *	1/2021	Andruchow	.....	B24D 15/04
2002/0109361	A1 *	8/2002	Parthenis	.....	A47G 21/001 294/219
2002/0129581	A1	9/2002	Correll		
2009/0114661	A1	5/2009	Lim		
2010/0282743	A1	11/2010	Blase		

2014/0314902	A1	10/2014	Maynard		
2014/0377424	A1	12/2014	Griebel		
2015/0164204	A1 *	6/2015	Moreau	.....	A45F 5/00 224/267

OTHER PUBLICATIONS

<https://amazon.com/dp/B07RSNJ6R>; The Burger Holder item for sale, printed out on Apr. 12, 2021.  
<https://biome.com/au/reusable-food-wraps-covers/22658-wrap-d-reusable-wrap-aqua.html>; printed Apr. 26, 2021.  
[https://www.biome.com.au/module/ambjolisearch/jolisearch?search\\_query=Wrap%27d+Reusable+Wrap+Holder](https://www.biome.com.au/module/ambjolisearch/jolisearch?search_query=Wrap%27d+Reusable+Wrap+Holder); printed Apr. 26, 2021.  
<https://www.youtube.com/watch?v=n4t71PrFuS0>.  
<https://www.youtube.com/watch?v=Exj2tbxkdpM>.  
<https://www.youtube.com/watch?v=o4eMHDHIUk>.  
<https://packagingoftheworld.com/2015/04/neato-burrito-student-project.html>; printed Apr. 26, 2021.  
<https://www.istockphoto.com/photo/tortilla-wraps-in-holder-surrounded-by-vegetables-gm187168293-28713918>; printed Apr. 26, 2021.  
<https://biome.com/au/441-sandwich-wrap>; printed Apr. 26, 2021.  
<https://biome.com/au/lunch-boxes/17116-wrappa-organic-cotton-vegan-wax-wrap-set-of-3.html>; printed Apr. 26, 2021.  
<https://www.biome.com.au/reusable-food-wraps-covers/12992-honeybee-food-wraps-4-kitchen-collection-set.html>; printed Apr. 26, 2021.  
<https://www.worldbid.com/consumer-goods-appliances/kitchenware-cutlery-utensils/reusable-silicone-sandwich-bag-i130183.html>; printed Apr. 26, 2021.  
<https://www.treehugger.com/green-home/say-goodbye-ziplocs-forever-bbagz-innovative-replacement.html>; printed Apr. 26, 2021.  
<https://www.officeworks.com.au/shop/officeworks/p/nude-food-movers-wrap-and-roll-sm25704>; printed Apr. 26, 2021.  
<https://amazon.com/Paper-Sandwich-Wrap-Display-Restaurantware/dp/B0cXYK91BL>; printed Apr. 26, 2021.  
<https://www.east2eden.co.uk/shop/producttype/kitchen-craft-set-of-4-plastic-individual-fajita-tortilla-wrap-holder-sleeve>; printed Apr. 26, 2021.  
<https://www.packagingenvironmental.co.uk/wrap-packaging-c25/wraps-t64>; printed Apr. 26, 2021.

\* cited by examiner

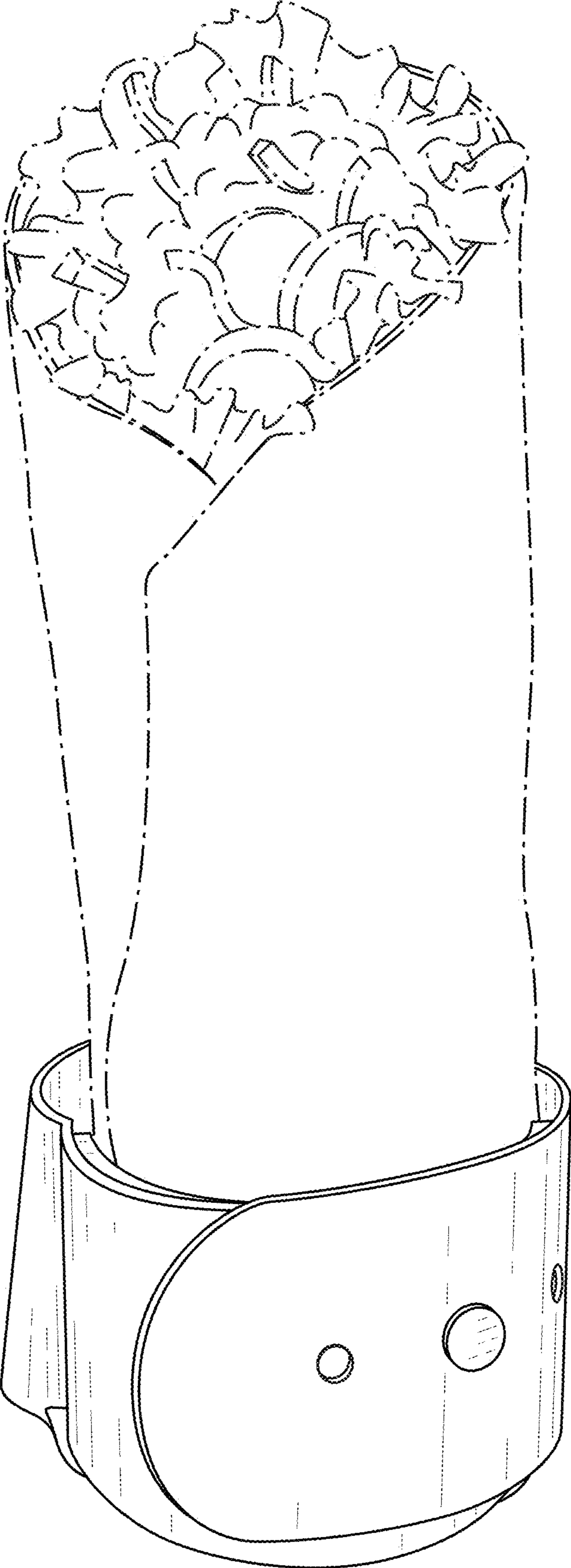

FIG. 1



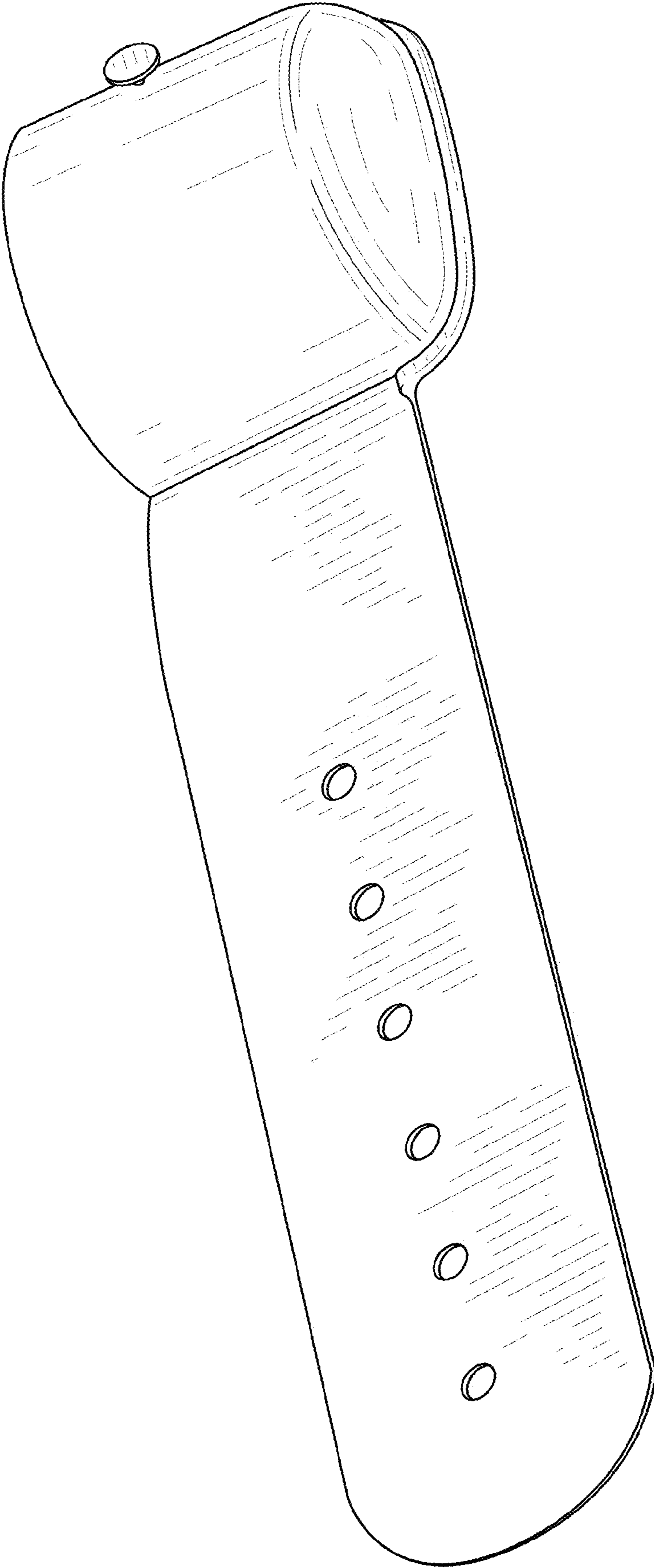

FIG. 2

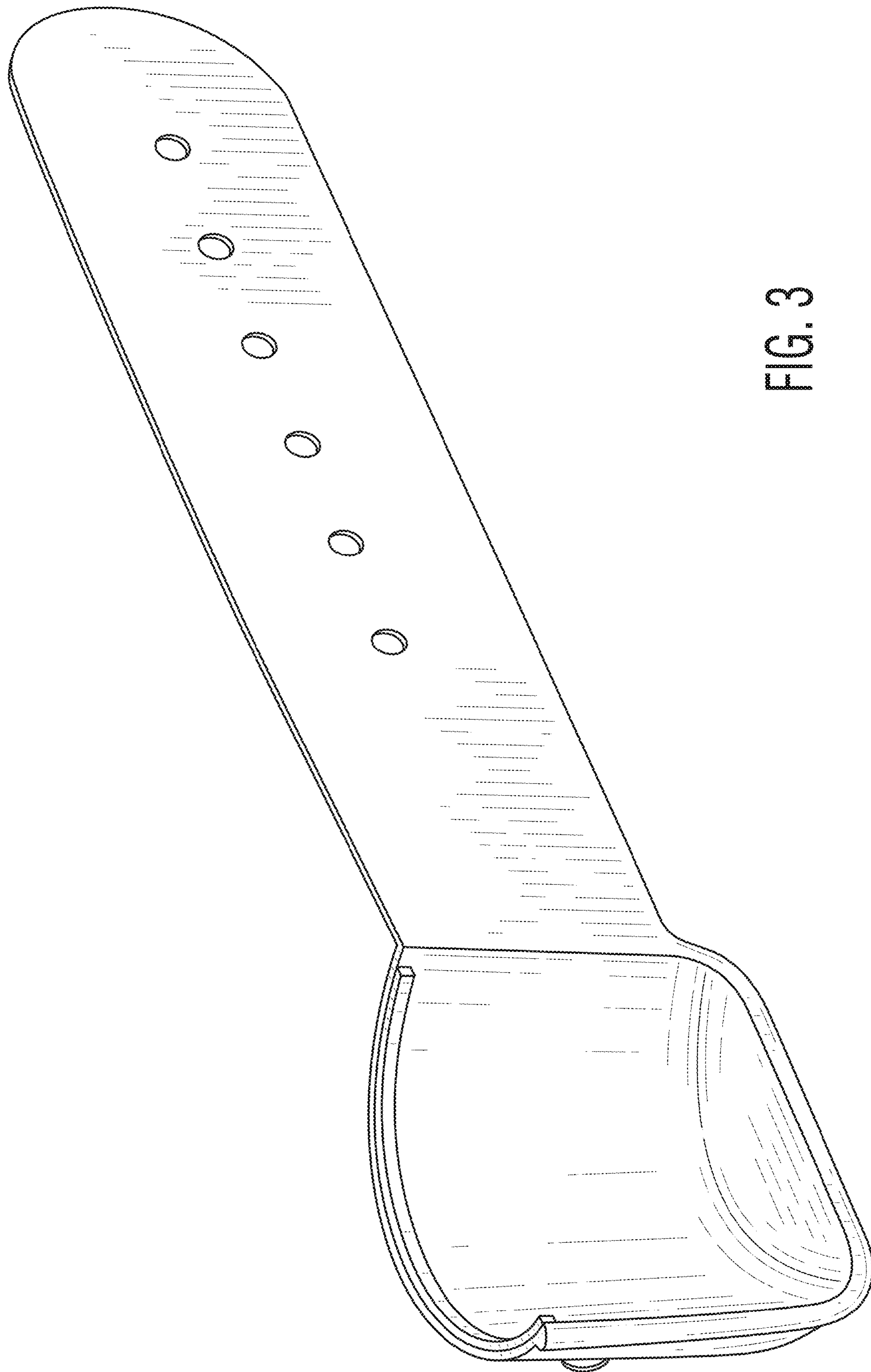

FIG. 3

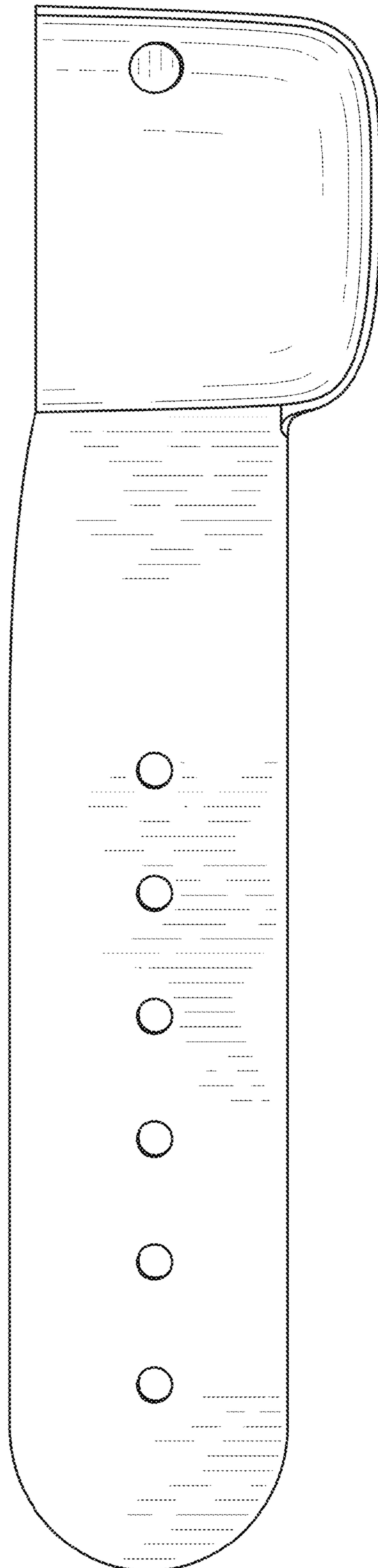

FIG. 4

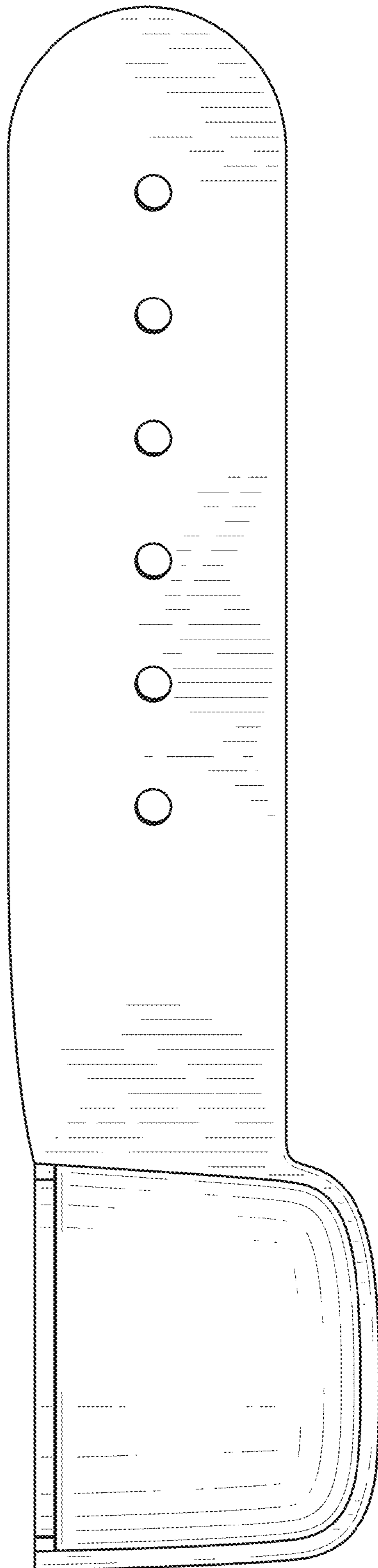

FIG. 5

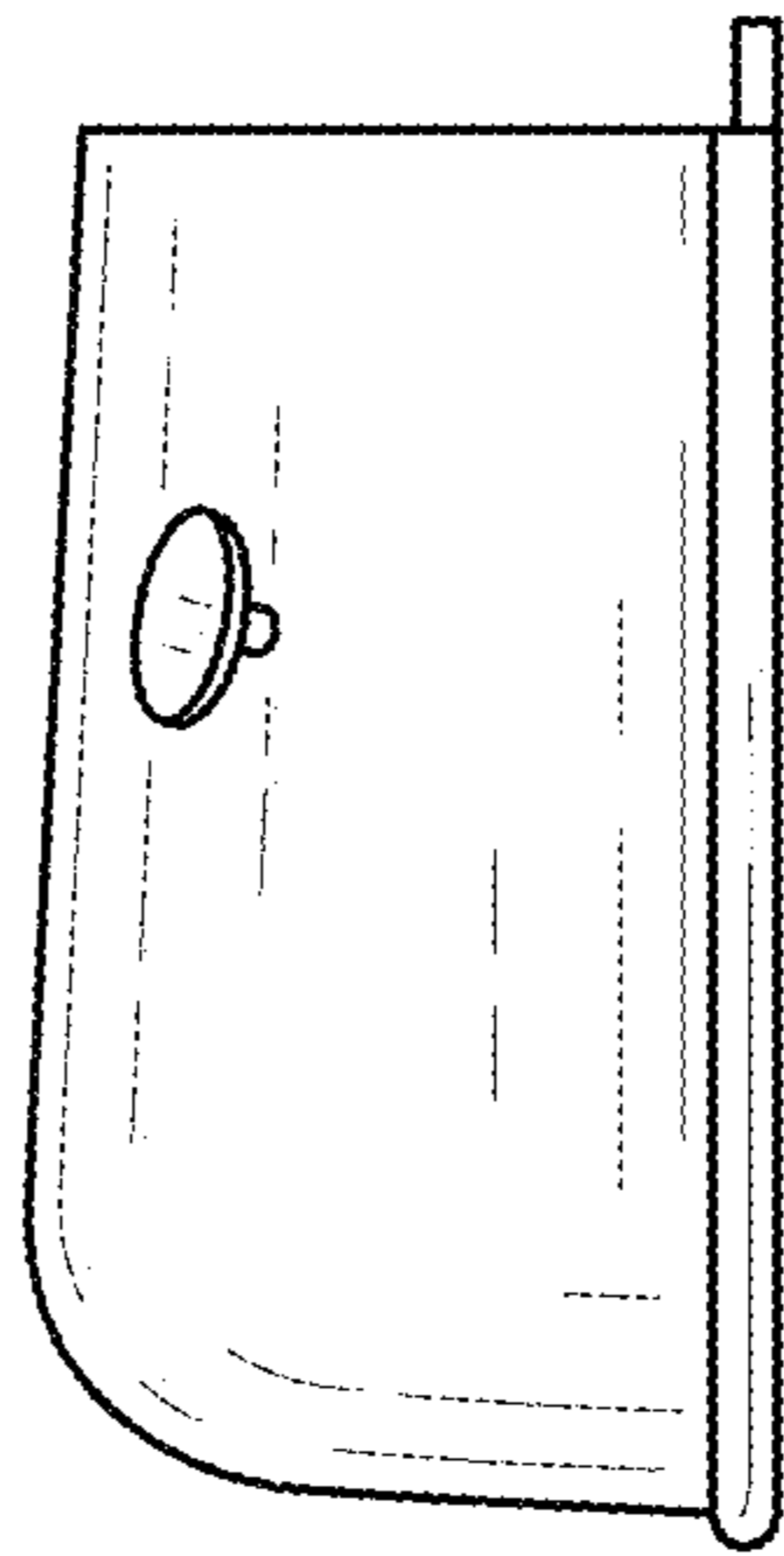

FIG. 6

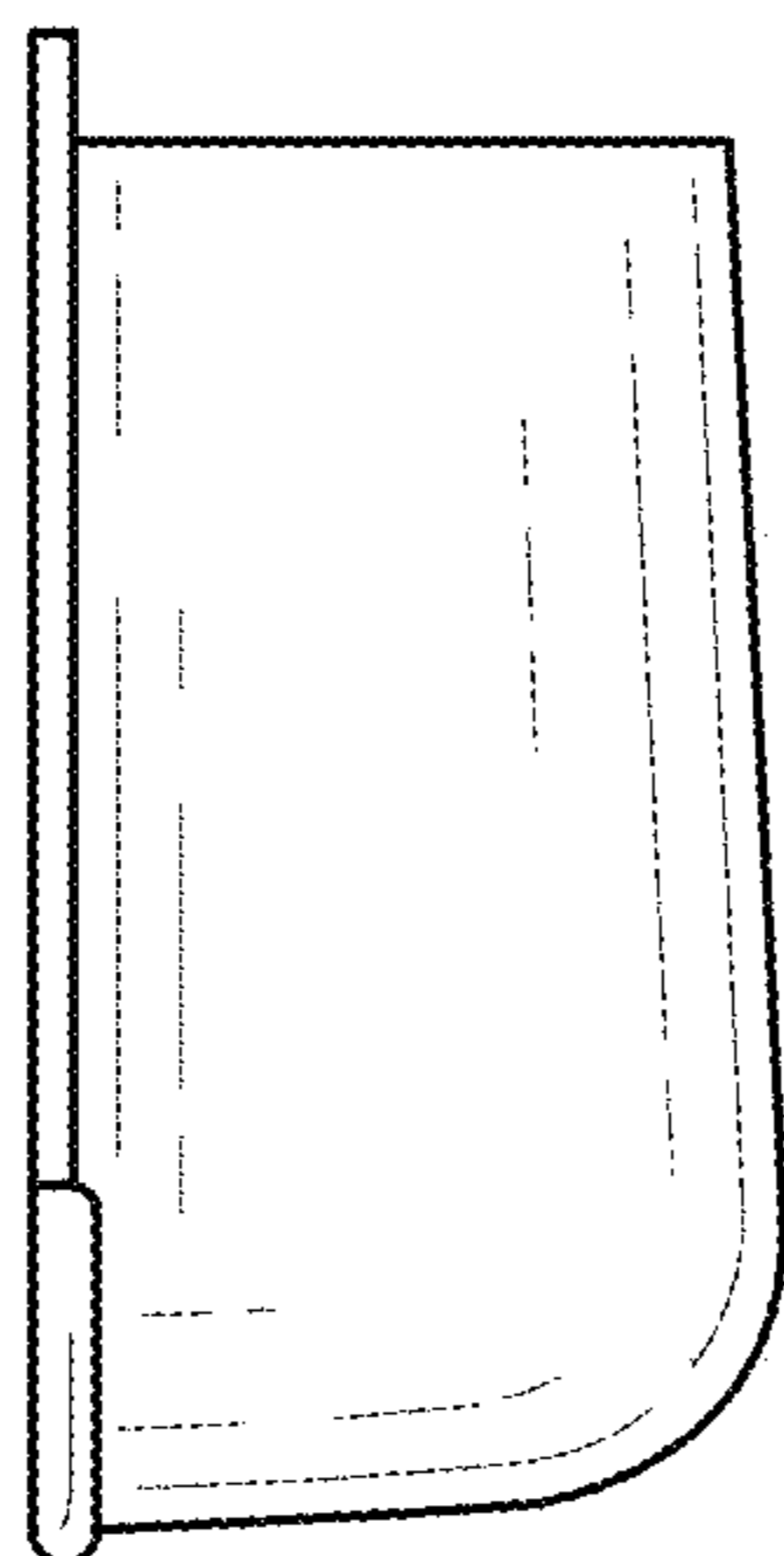

FIG. 7





FIG. 8

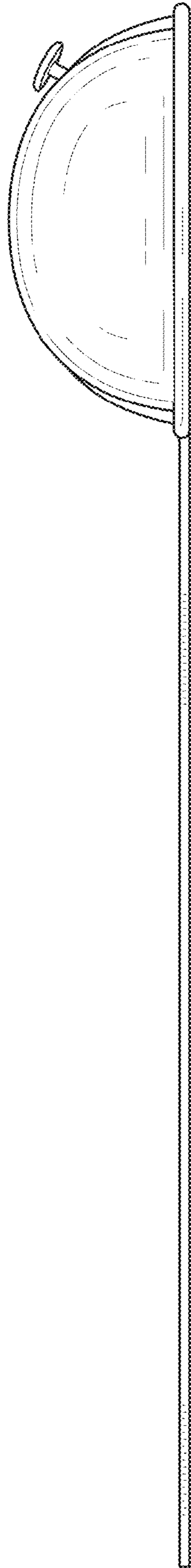

FIG. 9