



US00D985975S

(12) **United States Design Patent** (10) **Patent No.:** **US D985,975 S**  
**Xiao** (45) **Date of Patent:** **\*\* May 16, 2023**

(54) **STORAGE BOX**  
(71) Applicant: **TAIZHOU SUKK TECHNOLOGY CO., LTD.**, Taizhou (CN)  
(72) Inventor: **Shuangshuang Xiao**, Taizhou (CN)  
(\*\*) Term: **15 Years**  
(21) Appl. No.: **29/856,598**  
(22) Filed: **Oct. 14, 2022**  
(51) **LOC (14) Cl.** ..... **06-04**  
(52) **U.S. Cl.**  
USPC ..... **D6/667**  
(58) **Field of Classification Search**  
USPC ..... D6/661, 663, 667, 671, 705  
CPC ..... A47B 43/00; A47B 47/042; A47B 47/05;  
A47B 67/02; A47B 77/02; A47B 81/00;  
A47B 81/005; A47B 87/002; A47B  
87/005; A47B 96/169; A47B 97/00; E04H  
1/00; E04H 1/1205; E04H 1/005; E04H  
1/12; E04H 1/1283; D06F 57/10; E04B  
1/34321; E04B 1/34331; E04B 1/3483;  
E04B 1/34807; E04B 1/343; E04B 1/348;  
E06B 1/04; A47F 9/00  
See application file for complete search history.

(56) **References Cited**  
U.S. PATENT DOCUMENTS  
D420,541 S 2/2000 Zaiman  
D426,724 S 6/2000 Stangl  
D442,780 S 5/2001 Hiernard  
D448,586 S 10/2001 O'Hare et al.  
D483,190 S \* 12/2003 Richardson ..... D6/336  
D497,252 S 10/2004 Perella et al.  
D810,475 S \* 2/2018 Ben Avi ..... D6/667  
D850,821 S \* 6/2019 Pontillas ..... D6/667  
D870,494 S \* 12/2019 Leng ..... D6/667  
D880,906 S \* 4/2020 Leng ..... D6/663  
D880,907 S \* 4/2020 Leng ..... D6/667  
D881,612 S \* 4/2020 Leng ..... D6/663  
D881,613 S \* 4/2020 Leng ..... D6/663  
D914,401 S \* 3/2021 Leng ..... D6/668.1

D914,402 S \* 3/2021 Xiao ..... D6/667  
D914,403 S \* 3/2021 Xiao ..... D6/667  
D914,404 S \* 3/2021 Xiao ..... D6/667  
D937,438 S \* 11/2021 Simonetti ..... D6/671.1  
D937,439 S \* 11/2021 Simonetti ..... D6/671.1  
(Continued)

**OTHER PUBLICATIONS**

“51 Gallon Patio Medium Deck Box” Dec. 30, 2020, amazon.com, site visited Jan. 13, 2023 <[https://www.amazon.com/Lightweight-Resistant-Garden-Container-Furniture-Cushions/dp/B08RYDN3RV/ref=sr\\_1\\_115?crd=1SWK0SF3TBHS3&keywords=deck%2Bbox&qid=1673573077&sprefix=deck%2Bbox%2Caps%2C449&sr=8-115&th=1](https://www.amazon.com/Lightweight-Resistant-Garden-Container-Furniture-Cushions/dp/B08RYDN3RV/ref=sr_1_115?crd=1SWK0SF3TBHS3&keywords=deck%2Bbox&qid=1673573077&sprefix=deck%2Bbox%2Caps%2C449&sr=8-115&th=1)> (Year: 2020).\*  
(Continued)

*Primary Examiner* — Kevin K Rudzinski  
*Assistant Examiner* — Paul D Bohannon

(57) **CLAIM**

The ornamental design for a storage box, as shown and described.

**DESCRIPTION**

FIG. 1 is a front, left, and top perspective view of a storage box, showing my new design;  
FIG. 2 is a front elevation view thereof;  
FIG. 3 is a rear view thereof;  
FIG. 4 is a left side elevation view thereof;  
FIG. 5 is a right side elevation view thereof;  
FIG. 6 is a top plan view thereof; and,  
FIG. 7 is an enlarged view of an encircled area labeled “7” in FIG. 1.  
The broken lines shown in the drawings are included for the purpose of illustrating portions of the storage box that form no part of the claimed design.  
Dot-dash broken lines in FIGS. 1 and 7 framing portions of the claimed design that are illustrated for enlargements form no part of the claimed design.

**1 Claim, 7 Drawing Sheets**

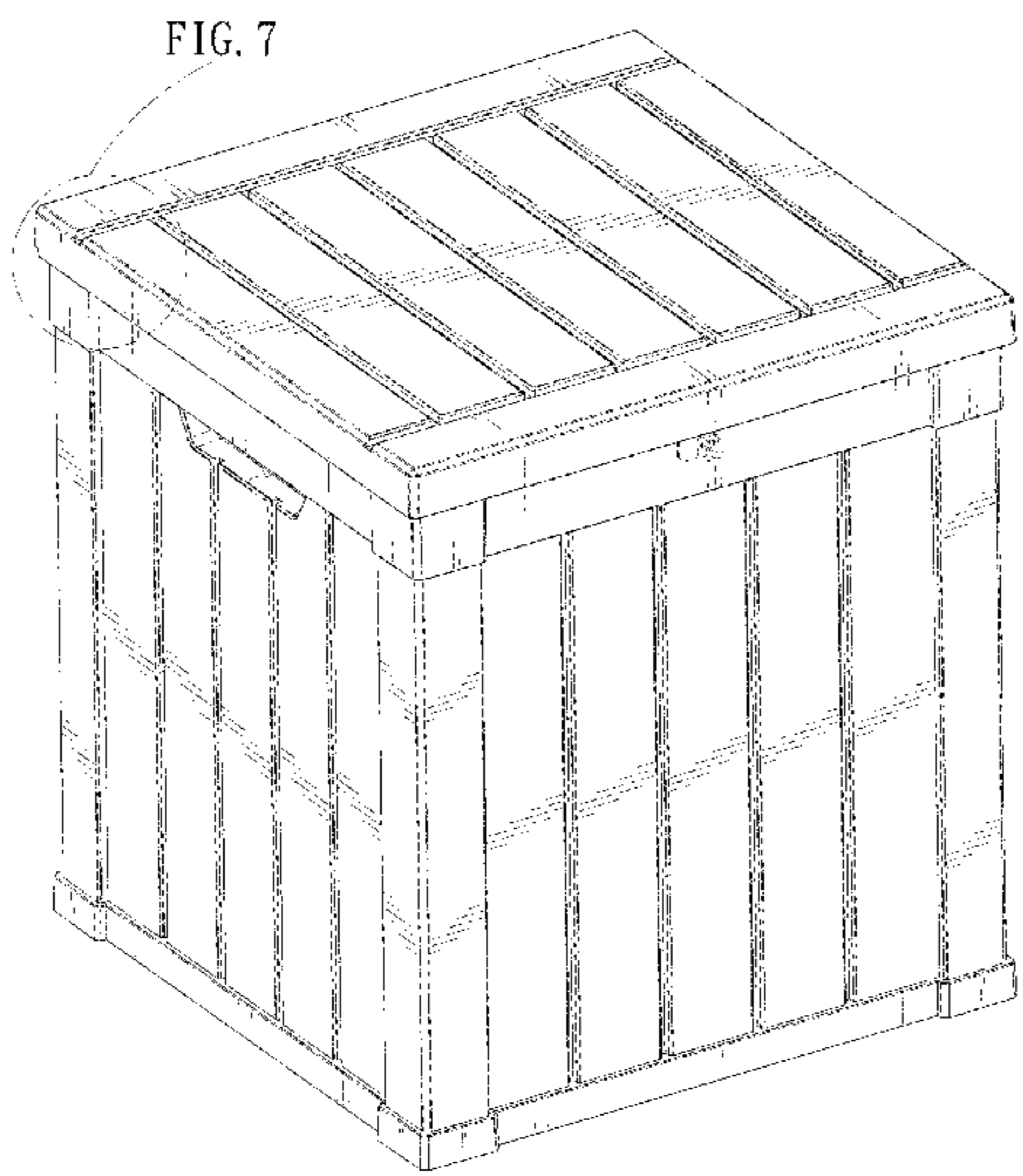

(56)

**References Cited**

U.S. PATENT DOCUMENTS

D938,199 S \* 12/2021 Anderson ..... D6/667  
D938,200 S \* 12/2021 Anderson ..... D6/667  
D947,582 S \* 4/2022 Kopp ..... D6/667  
D954,476 S \* 6/2022 Kopp ..... D6/667  
D964,074 S \* 9/2022 Xiao ..... D6/667  
D964,784 S \* 9/2022 Anderson ..... D3/273  
D965,352 S \* 10/2022 Anderson ..... D6/667  
D968,132 S \* 11/2022 Sun ..... D6/667  
D968,133 S \* 11/2022 Sun ..... D6/667  
D972,166 S \* 12/2022 Whitehead ..... D6/671.1

OTHER PUBLICATIONS

Klein, Rachel. "The 10 Best Outdoor Storage and Deck Boxes for Taming Clutter," May 6, 2022, popularmechanics.com, site visited Jan. 13, 2023 <<https://www.popularmechanics.com/home/g36054252/best-deck-boxes/>> (Year: 2022).\*

\* cited by examiner

FIG. 7

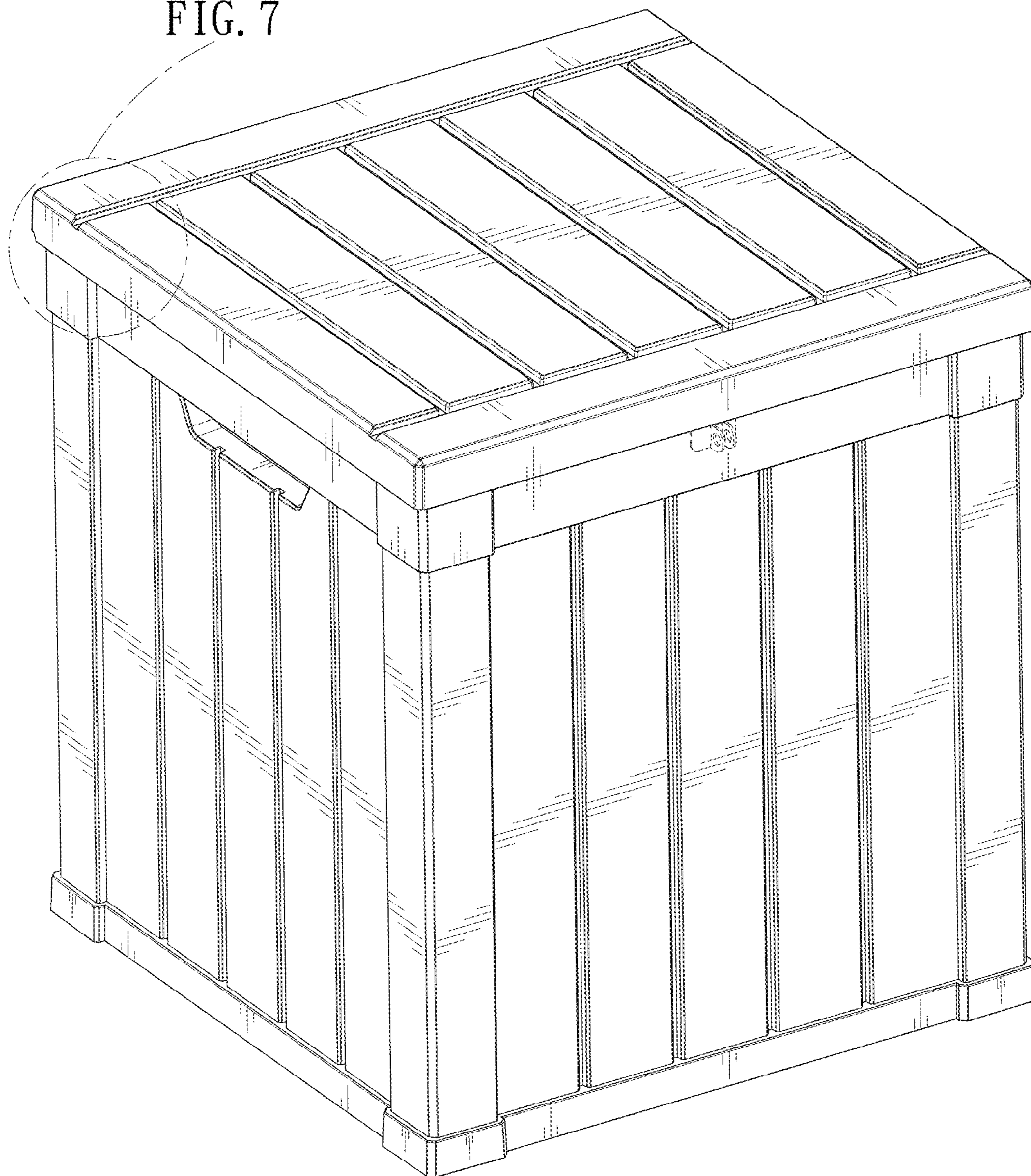

FIG. 1



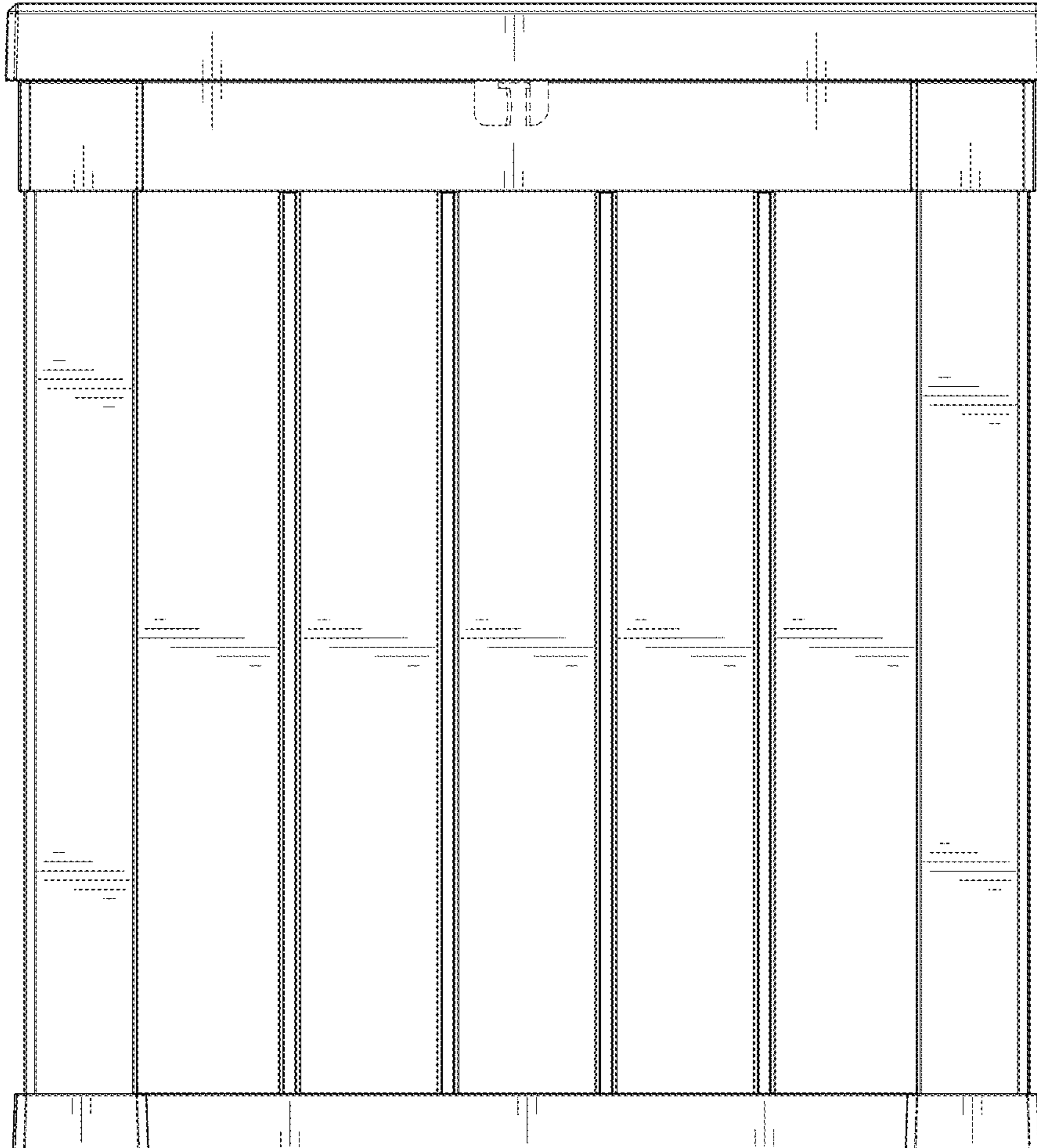

FIG. 2

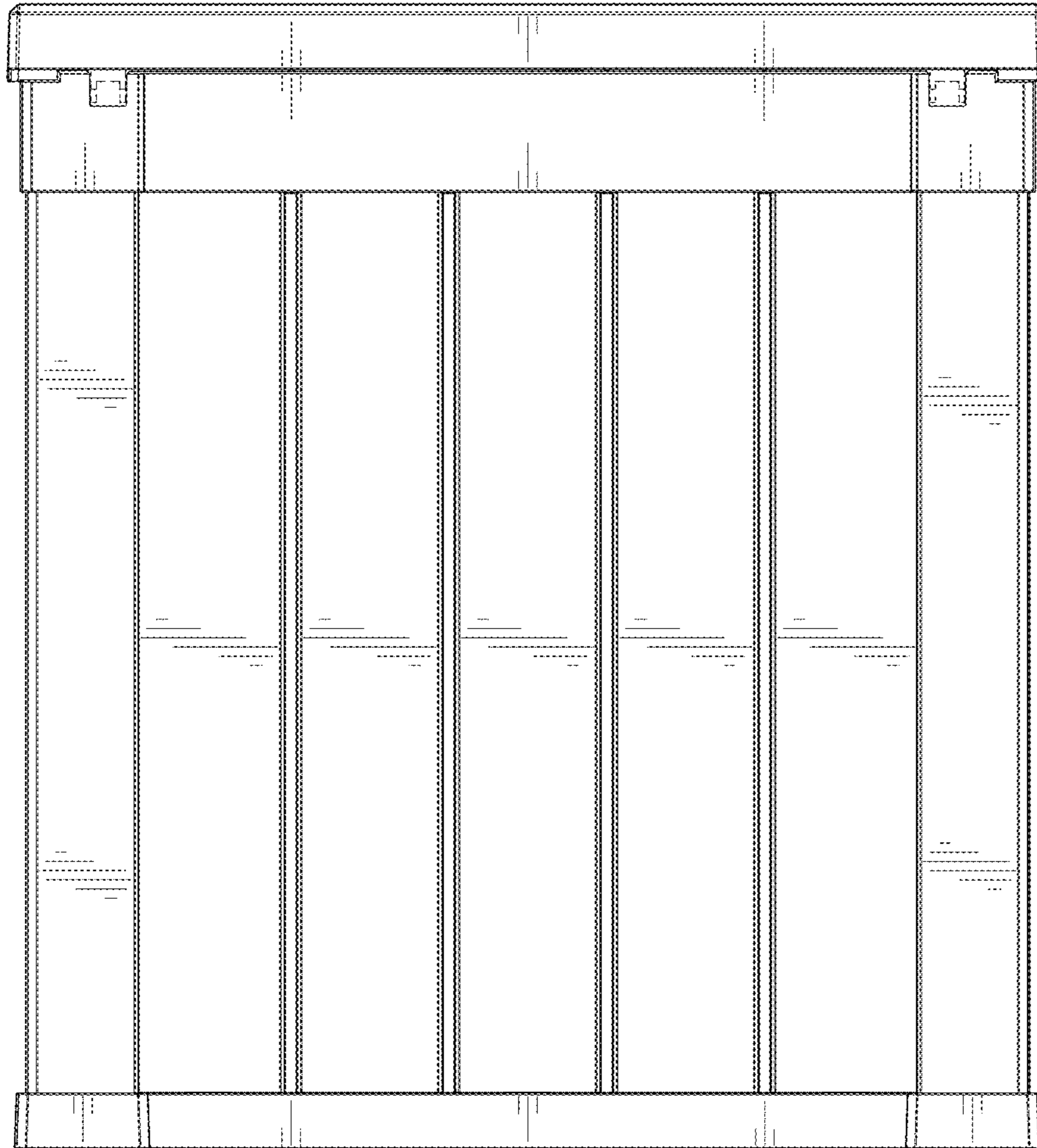

FIG. 3

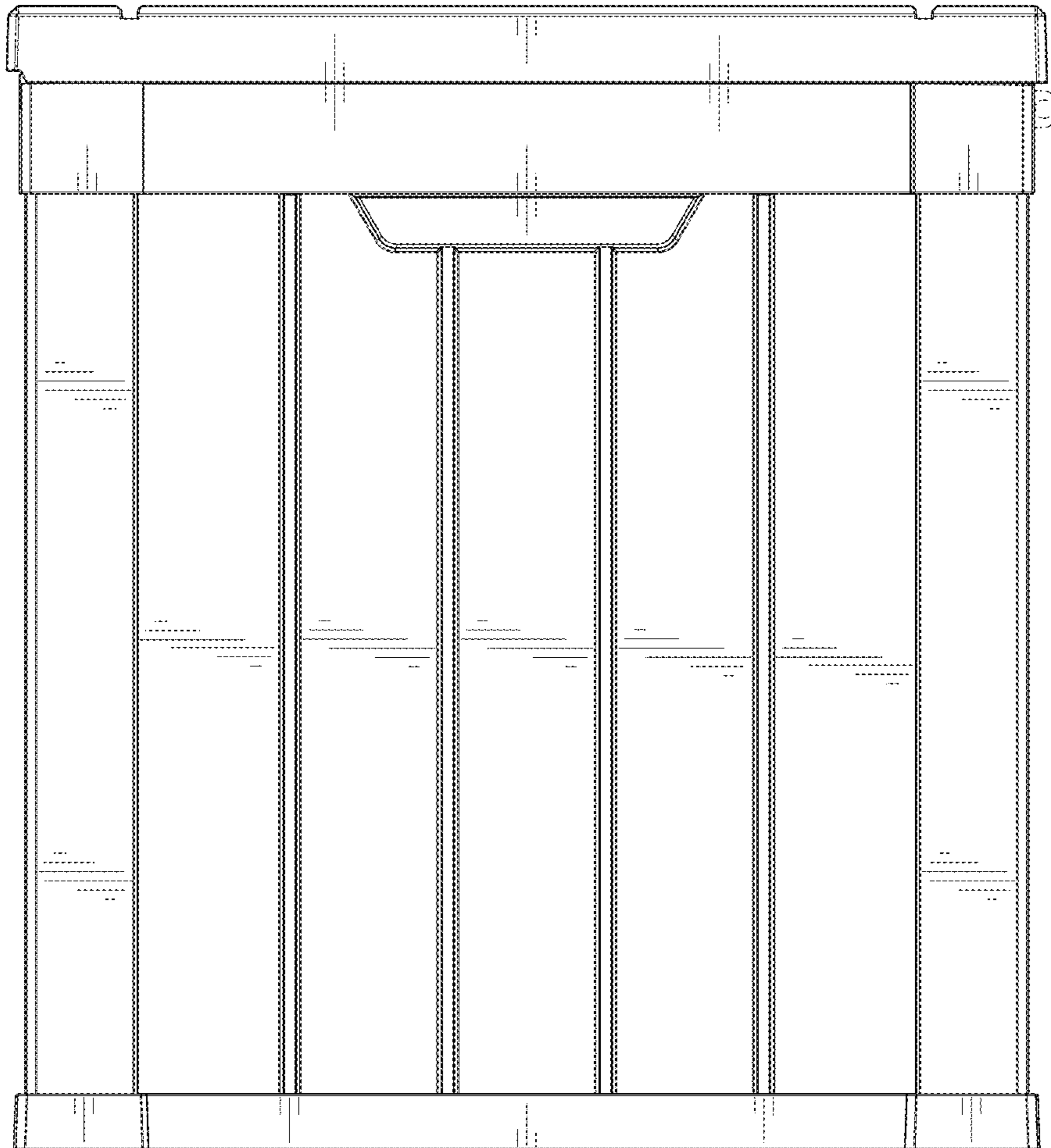

FIG. 4

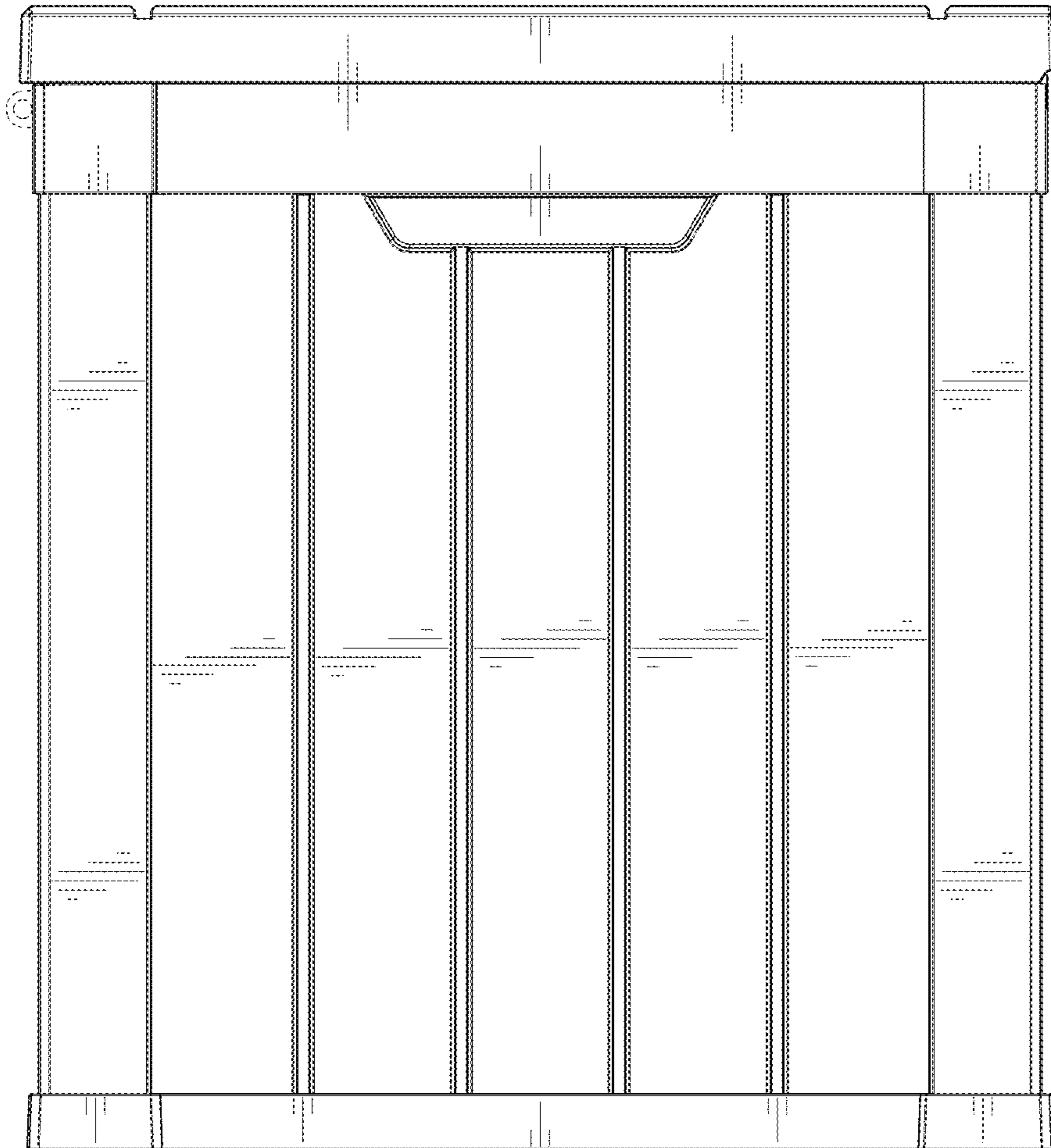

FIG. 5

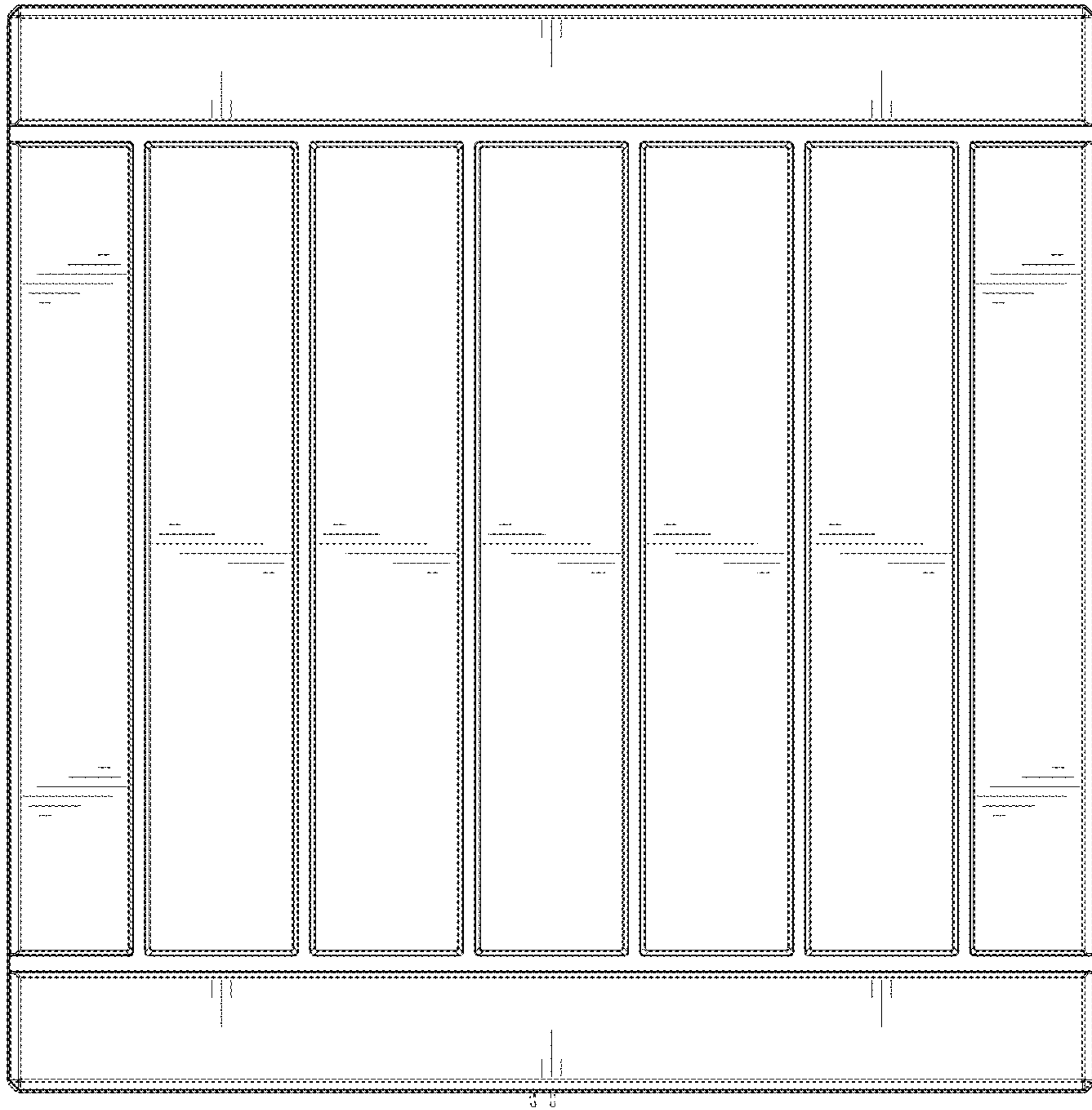

FIG. 6



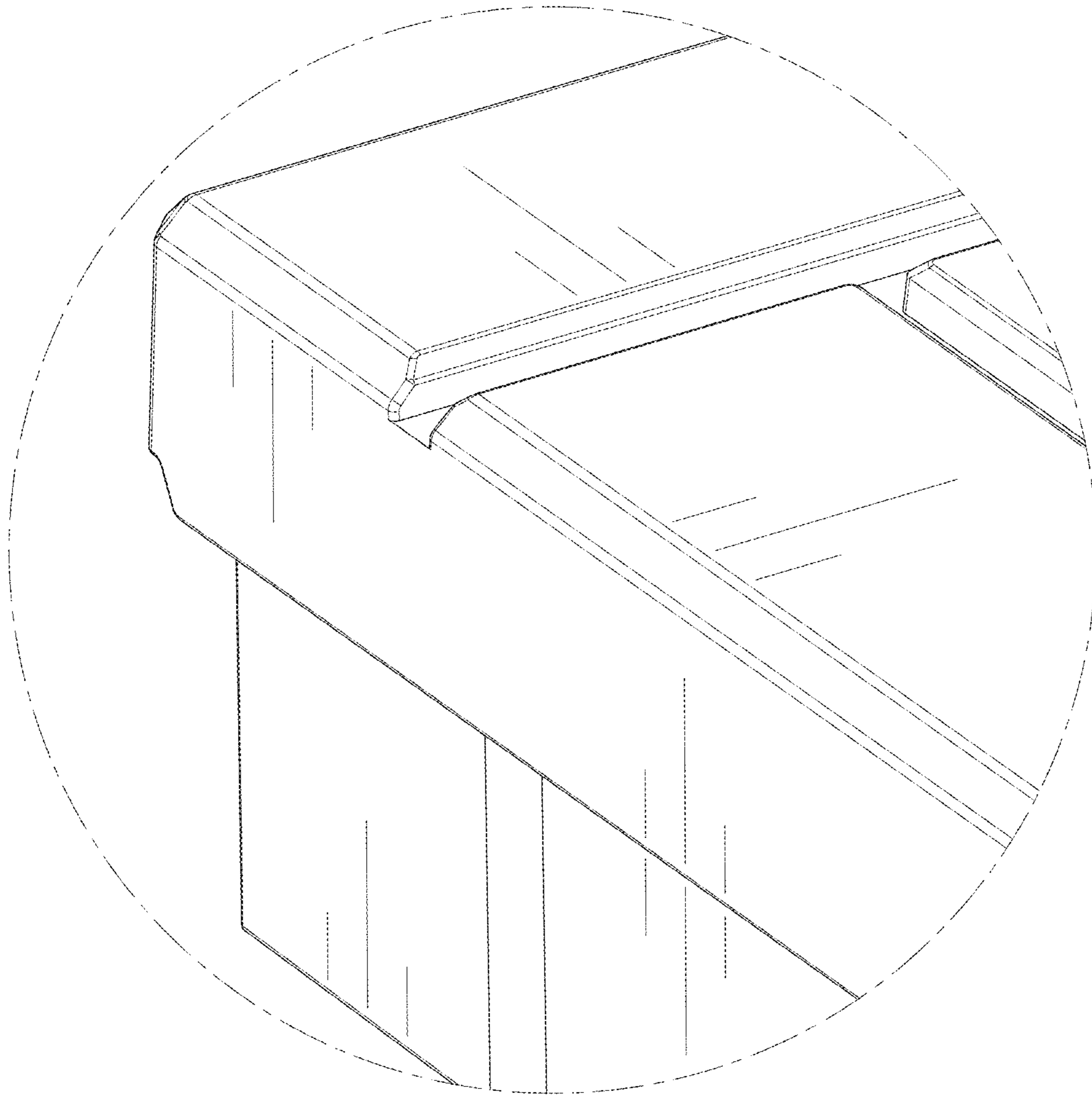

FIG. 7