



US00D985967S

(12) **United States Design Patent**
Bruns

(10) **Patent No.:** **US D985,967 S**

(45) **Date of Patent:** **** May 16, 2023**

(54) **DUVET COVER WITH A REMOVEABLE
PET PROTECTION LAYER**

(71) Applicant: **Michael S. Bruns**, Folsom, CA (US)

(72) Inventor: **Michael S. Bruns**, Folsom, CA (US)

(**) Term: **15 Years**

(21) Appl. No.: **29/778,180**

(22) Filed: **Apr. 12, 2021**

(51) **LOC (14) Cl.** **06-13**

(52) **U.S. Cl.**
USPC **D6/603**

(58) **Field of Classification Search**
USPC D6/582-583, 587-292, 595-609,
D6/617-622; D21/803-809

(Continued)

(56) **References Cited**

U.S. PATENT DOCUMENTS

2,821,723 A * 2/1958 Gluck A47G 9/0238
D6/602

D313,140 S * 12/1990 Johnson D6/602
(Continued)

Primary Examiner — Cynthia Ramirez

Assistant Examiner — Carrie A Matteoli

(74) *Attorney, Agent, or Firm* — Craig A. Simmerman

(57) **CLAIM**

I claim the ornamental design for a duvet cover with a removeable pet protection layer, as shown and described.

DESCRIPTION

FIG. 1 is a top perspective view of a duvet cover with a removeable pet protection layer, with the removeable pet protection layer attached, showing my new design;

FIG. 2 is a top plan view thereof;

FIG. 3 is a bottom plan view thereof;

FIG. 4 is a right side elevation view thereof;

FIG. 5 is a left side elevation view thereof;

FIG. 6 is a front elevation view thereof;

FIG. 7 is a rear elevation view thereof;

FIG. 8 is a top perspective view of a duvet cover with a removeable pet protection layer, with the removeable pet protection layer removed, showing my new design;

FIG. 9 is a top plan view thereof;

FIG. 10 is a bottom plan view thereof;

FIG. 11 is a right side elevation view thereof;

FIG. 12 is a left side elevation view thereof;

FIG. 13 is a front elevation view thereof;

FIG. 14 is a rear elevation view thereof;

FIG. 15 is a top perspective view of a second embodiment of a duvet cover with a removeable pet protection layer, with the removeable pet protection layer attached, showing my design;

FIG. 16 is a top plan view thereof;

FIG. 17 is a bottom plan view thereof;

FIG. 18 is a right side elevation view thereof;

FIG. 19 is a left side elevation view thereof;

FIG. 20 is a front elevation view thereof;

FIG. 21 is a rear elevation view thereof;

FIG. 22 is a top perspective view of a second embodiment of a duvet cover with a removeable pet protection layer, with the removeable pet protection layer removed, showing my new design;

FIG. 23 is a top plan view thereof;

FIG. 24 is a bottom plan view thereof;

FIG. 25 is a right side elevation view thereof;

FIG. 26 is a left side elevation view thereof;

FIG. 27 is a front elevation view thereof;

FIG. 28 is a rear elevation view thereof;

FIG. 29 is a top perspective view of a third embodiment of a duvet cover with a removeable pet protection layer, with the removeable pet protection layer attached, showing my design;

FIG. 30 is a top plan view thereof;

FIG. 31 is a bottom plan view thereof;

FIG. 32 is a right side elevation view thereof;

FIG. 33 is a left side elevation view thereof;

FIG. 34 is a front elevation view thereof;

FIG. 35 is a rear elevation view thereof;

(Continued)

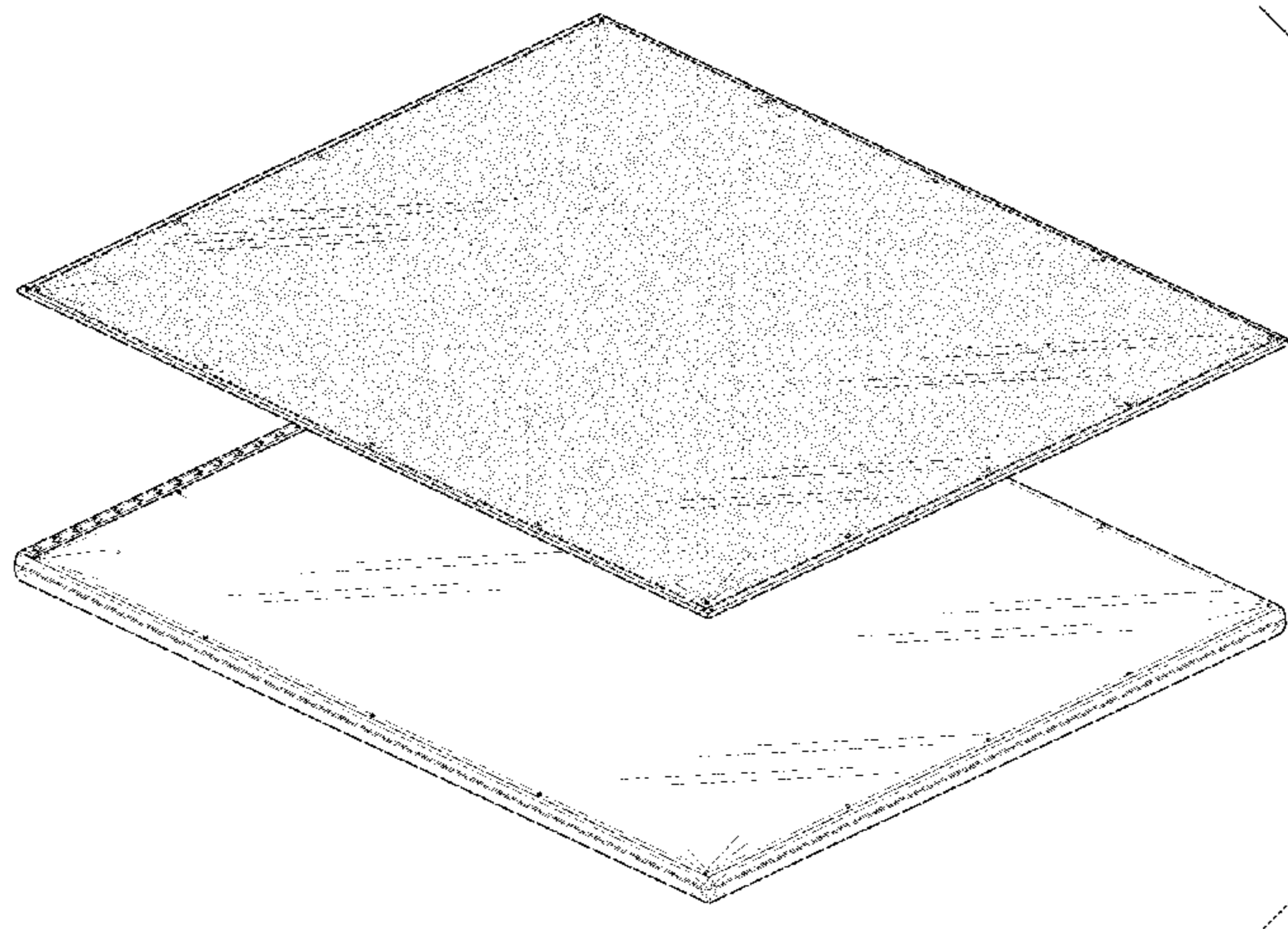

FIG. 36 is a top perspective view of a third embodiment of a duvet cover with a removeable pet protection layer, with the removeable pet protection layer removed, showing my new design;

FIG. 37 is a top plan view thereof;

FIG. 38 is a bottom plan view thereof;

FIG. 39 is a right side elevation view thereof;

FIG. 40 is a left side elevation view thereof;

FIG. 41 is a front elevation view thereof;

FIG. 42 is a rear elevation view thereof;

FIG. 43 is a top perspective view of a fourth embodiment of a duvet cover with a removeable pet protection layer, with the removeable pet protection layer attached, showing my design;

FIG. 44 is a top plan view thereof;

FIG. 45 is a bottom plan view thereof;

FIG. 46 is a right side elevation view thereof;

FIG. 47 is a left side elevation view thereof;

FIG. 48 is a front elevation view thereof;

FIG. 49 is a rear elevation view thereof;

FIG. 50 is a top perspective view of a fourth embodiment of a duvet cover with a removeable pet protection layer, with the removeable pet protection layer removed, showing my new design;

FIG. 51 is a top plan view thereof;

FIG. 52 is a bottom plan view thereof;

FIG. 53 is a right side elevation view thereof;

FIG. 54 is a left side elevation view thereof;
FIG. 55 is a front elevation view thereof; and,
FIG. 56 is a rear elevation view thereof.

1 Claim, 40 Drawing Sheets

(58) **Field of Classification Search**

CPC A47G 9/00; A47G 9/10; A47G 9/1009;
A47G 9/1045; A47G 9/1081; A47G
9/109; A47G 9/0253; A47G 2009/001;
A47G 2009/002; A47G 2009/003; A47G
2009/1018

See application file for complete search history.

(56) **References Cited**

U.S. PATENT DOCUMENTS

D319,366	S *	8/1991	Popovich	D6/602
D468,951	S *	1/2003	Harris	D6/596
7,228,578	B2 *	6/2007	Linnane	A47G 9/0261 5/502
10,413,099	B2 *	9/2019	Stewart	A47G 9/0261
10,674,844	B2 *	6/2020	Stinchcomb	A47G 9/02
2008/0236501	A1 *	10/2008	Hargrave	A01K 1/0353 119/28.5
2021/0392851	A1 *	12/2021	Russ	A01K 1/0353

* cited by examiner

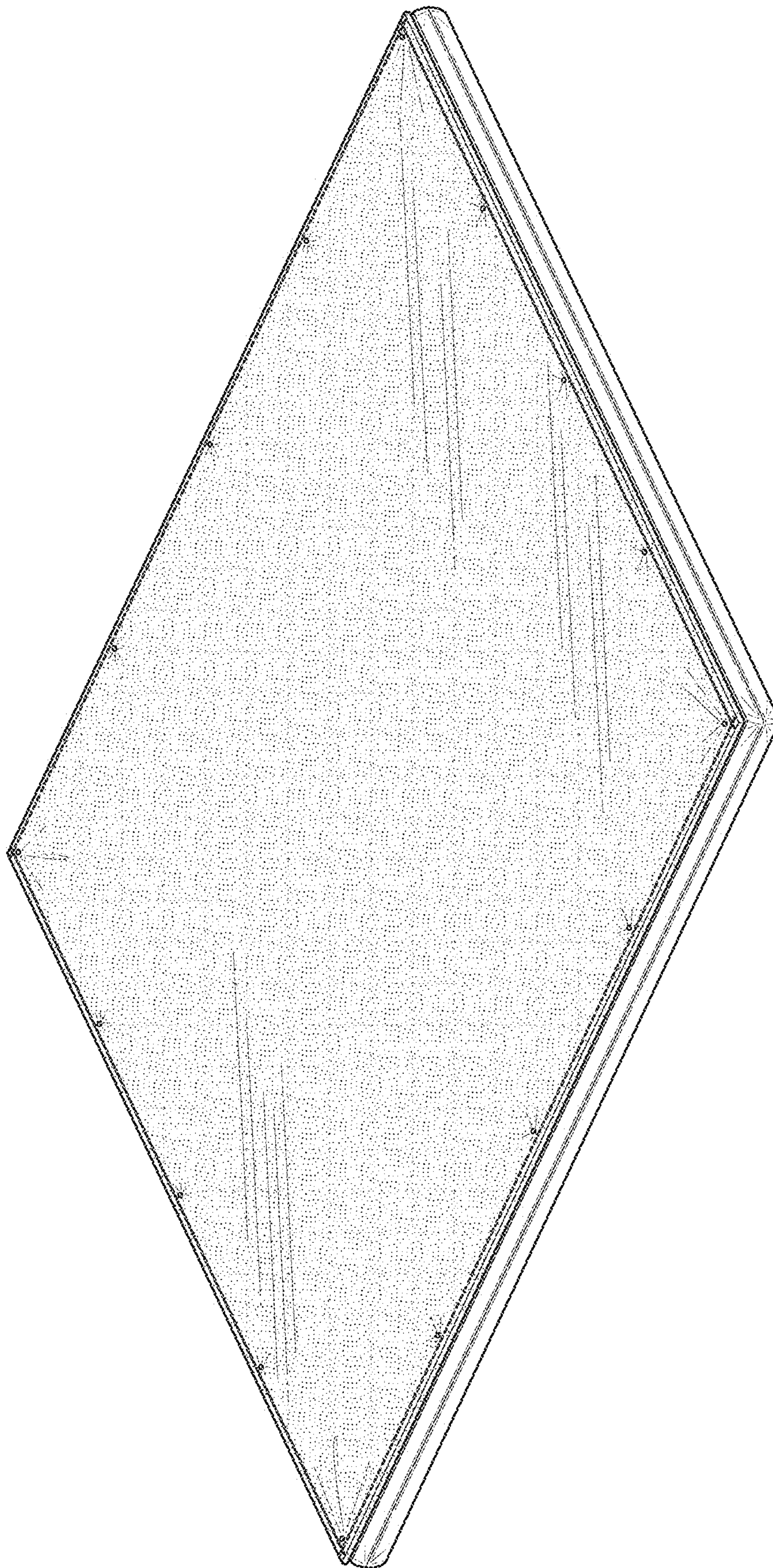

FIG. 1



FIG. 2

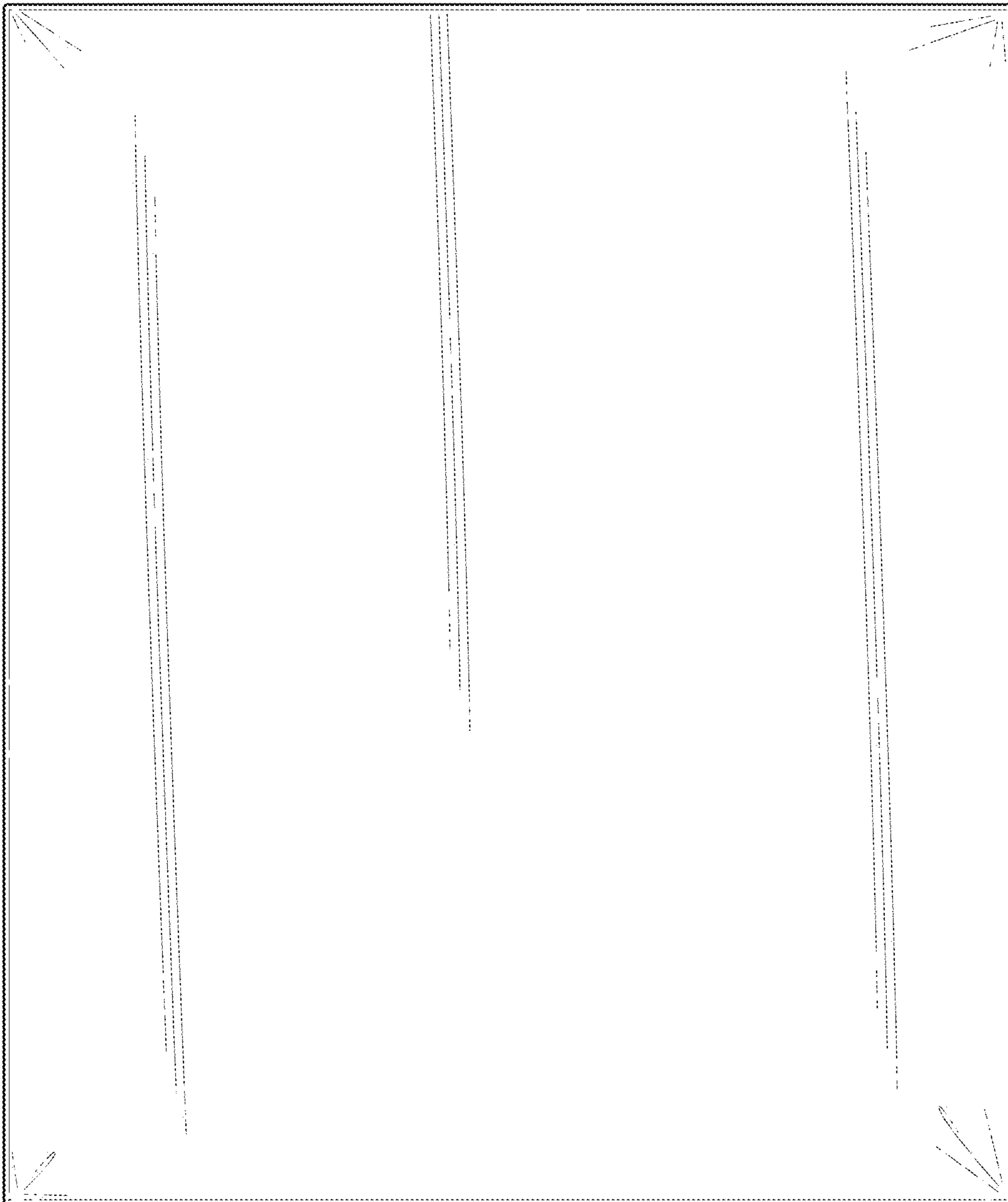

FIG. 3

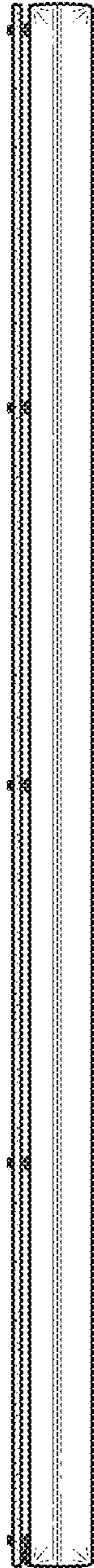

FIG. 4

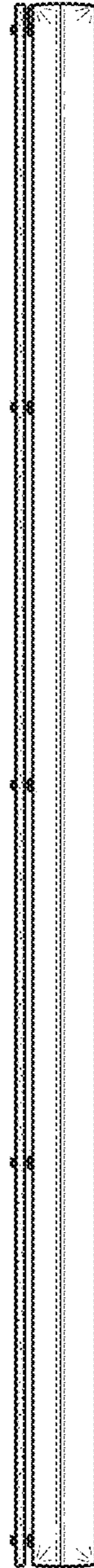

FIG. 5

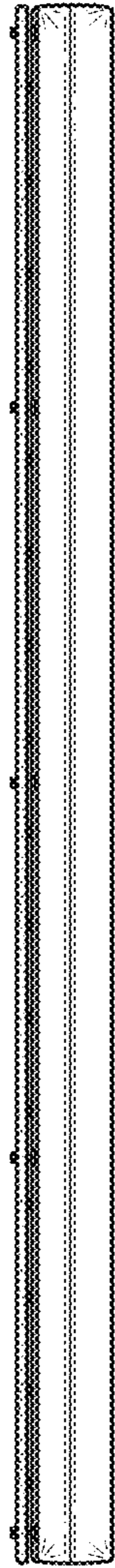

FIG. 6

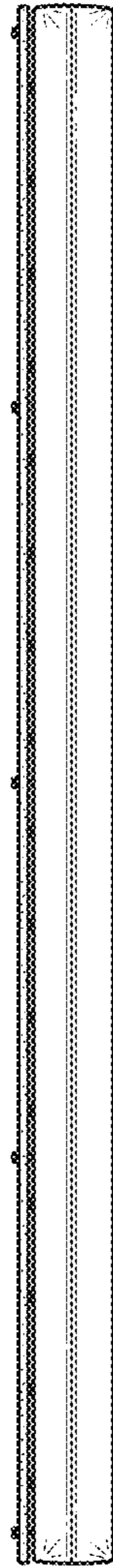

FIG. 7

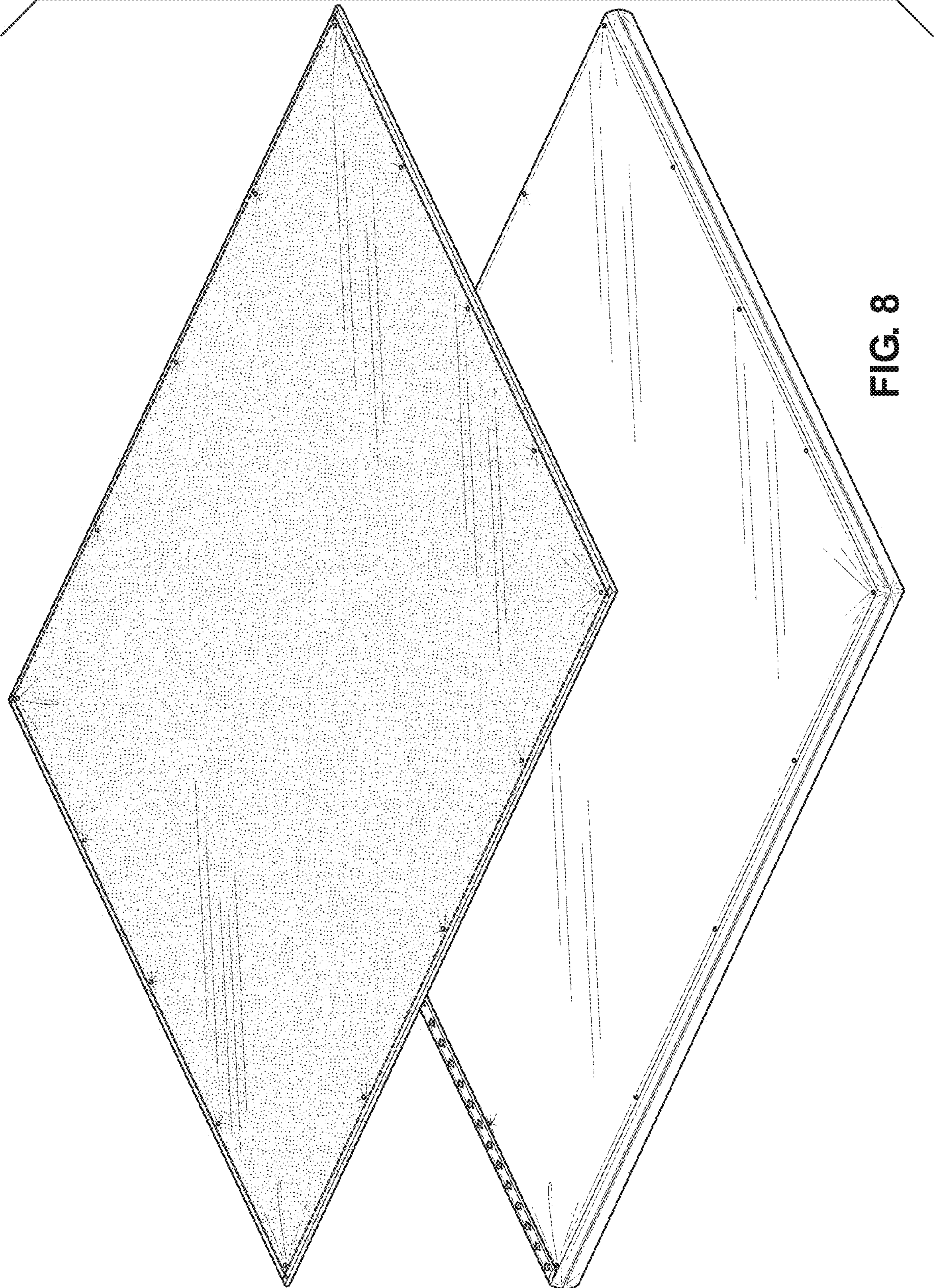

FIG. 8

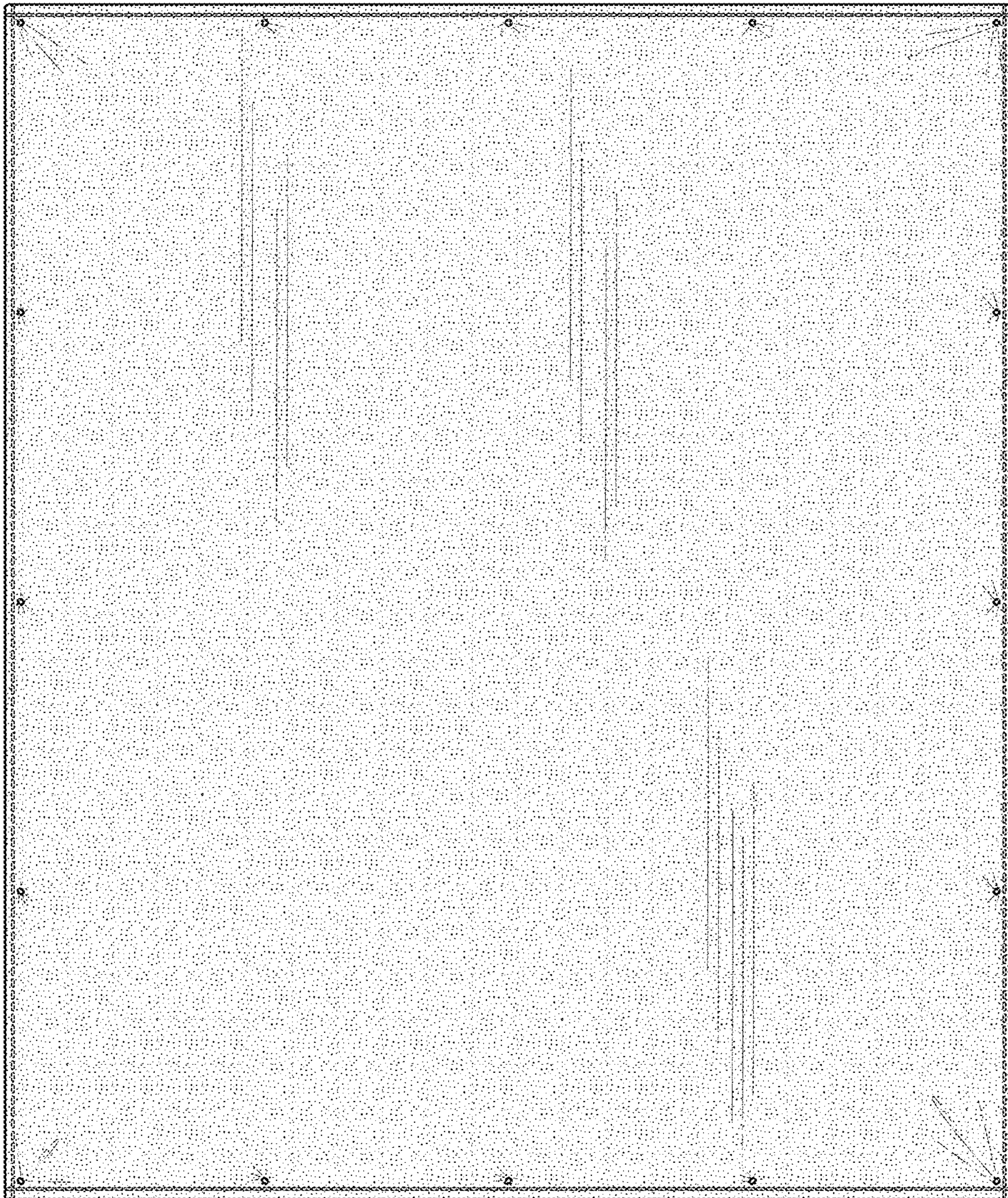

FIG. 9

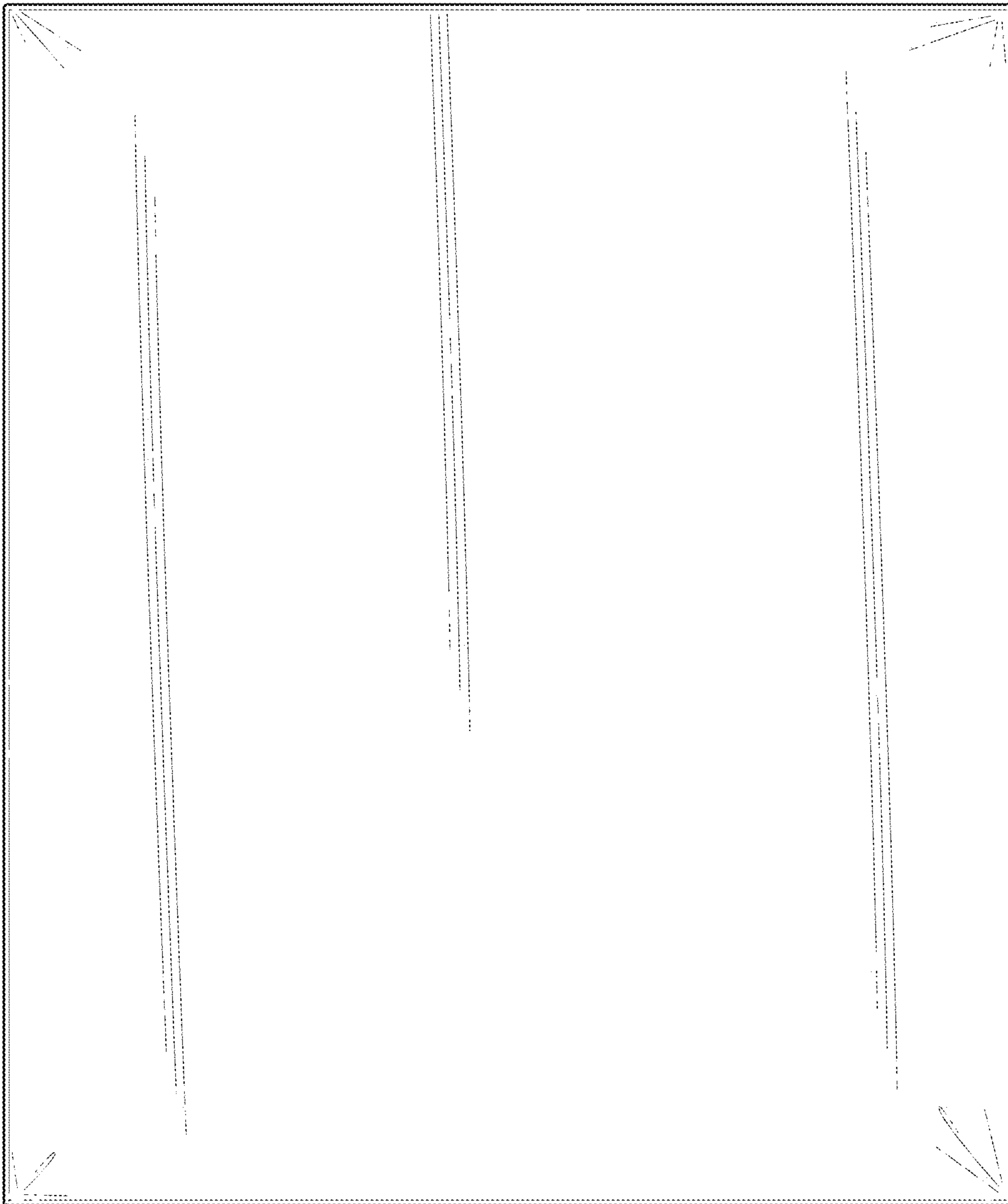

FIG. 10

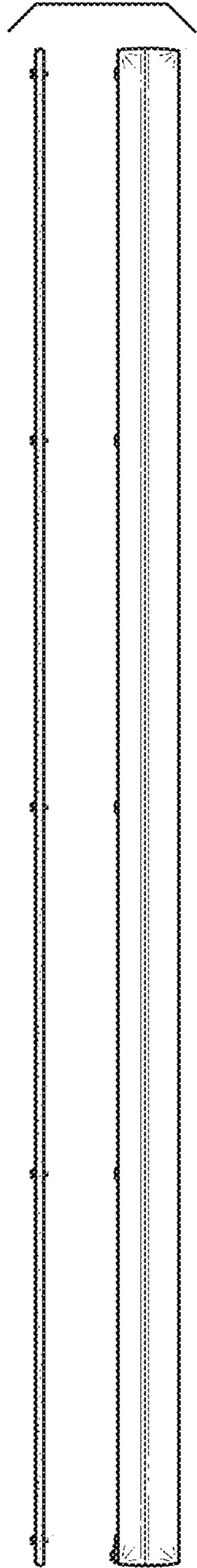

FIG. 11

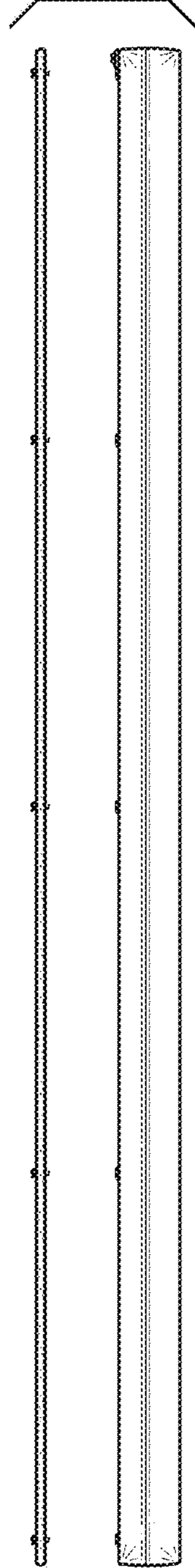

FIG. 12

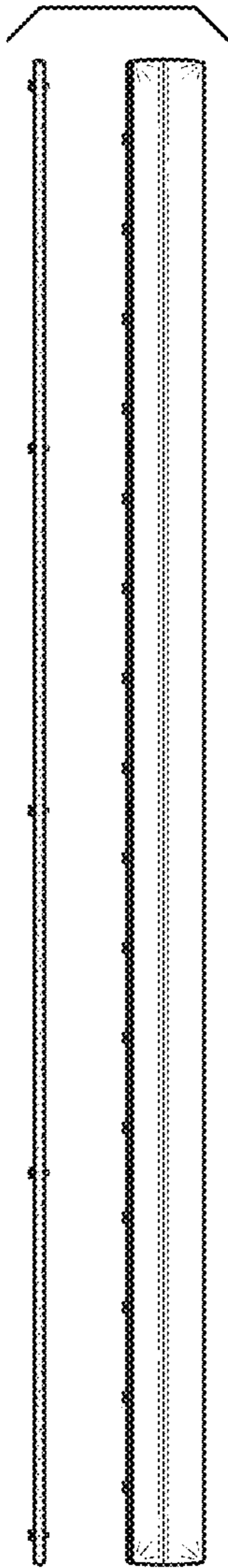

FIG. 13

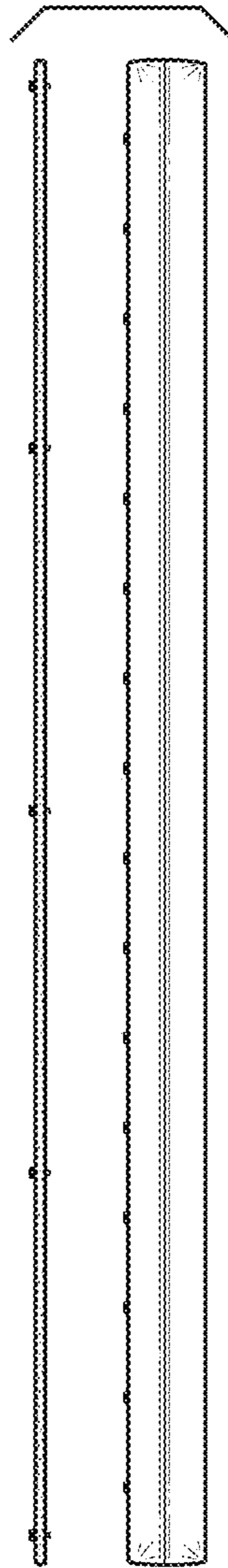

FIG. 14

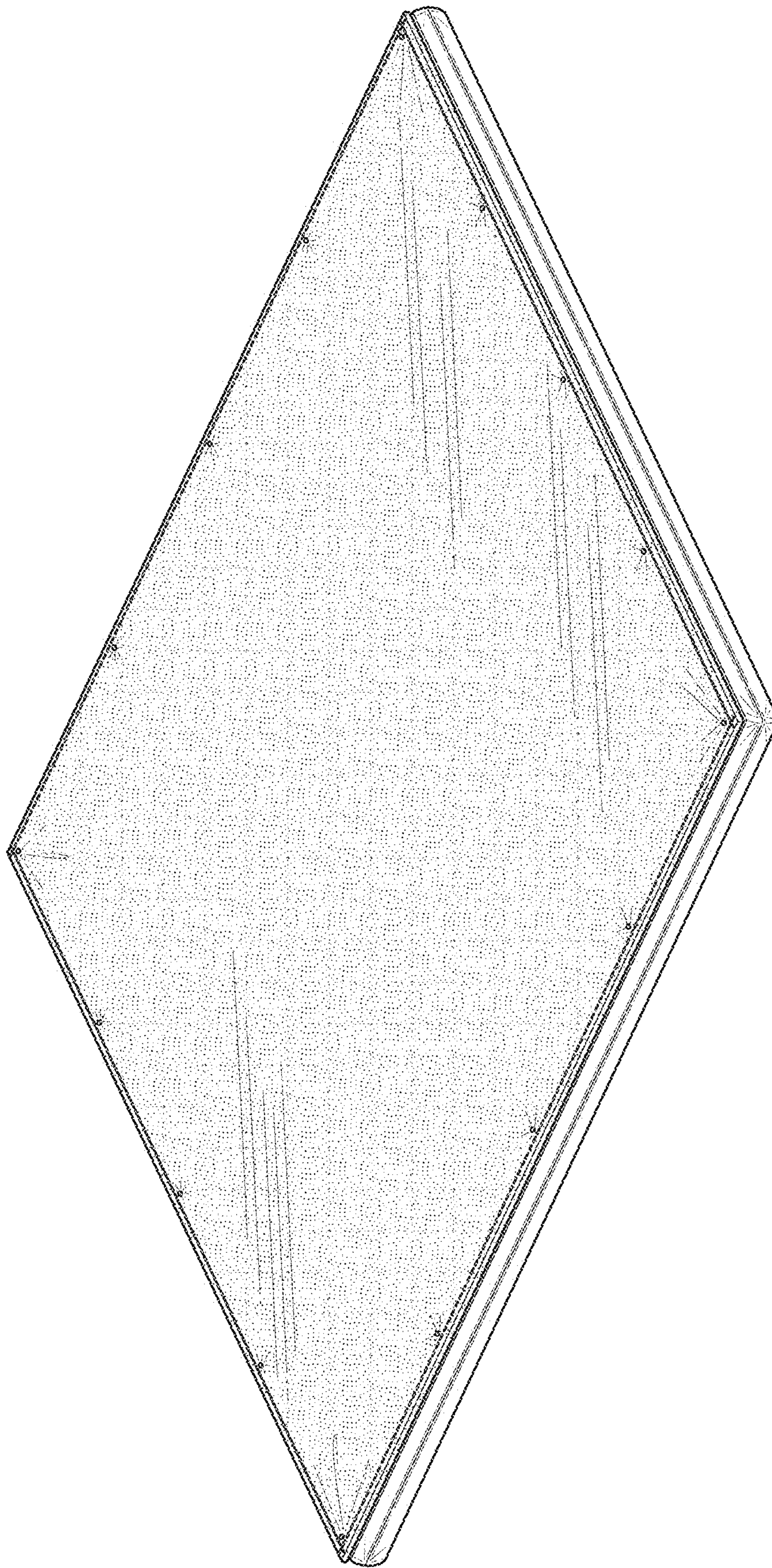

FIG. 15

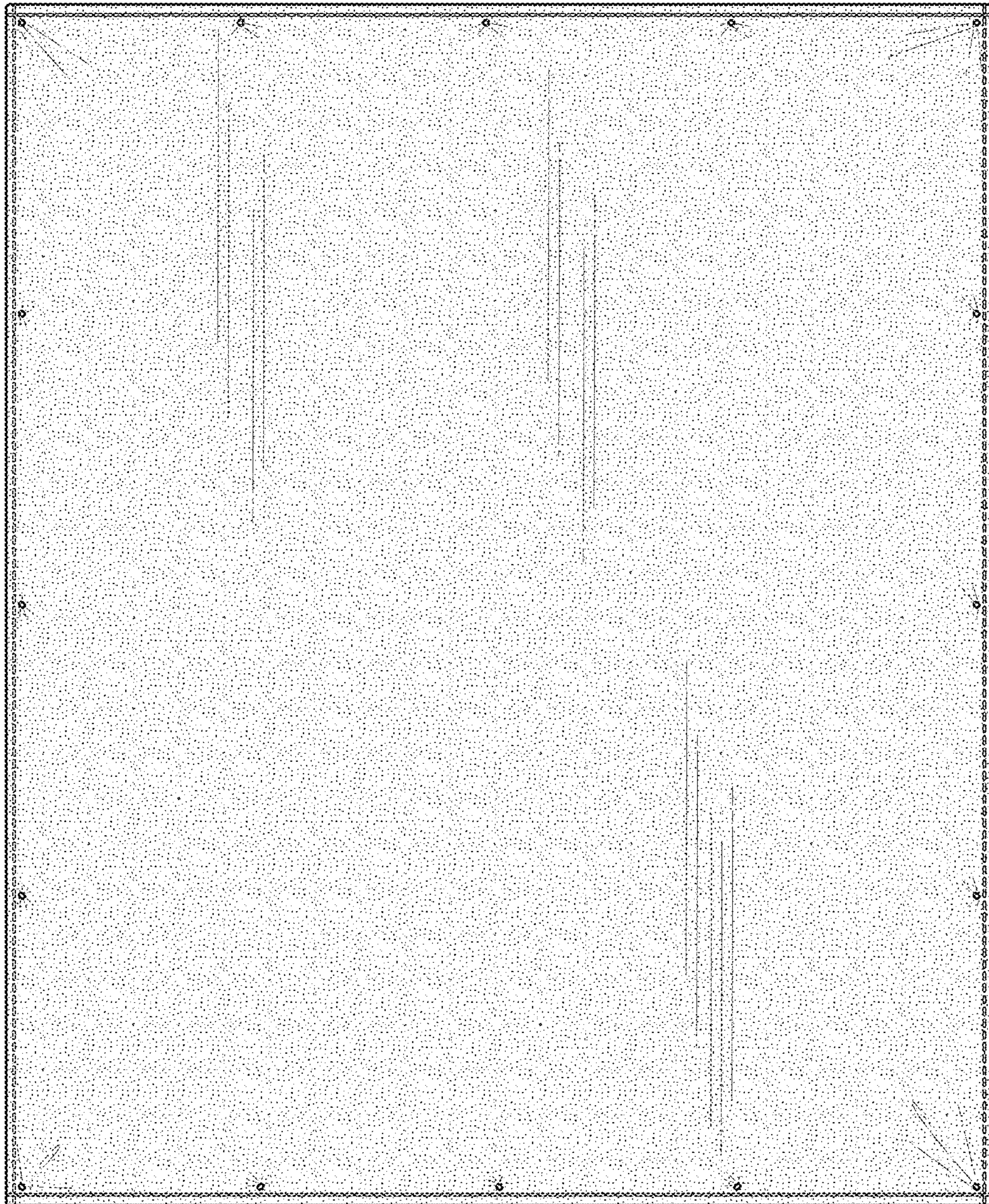

FIG. 16

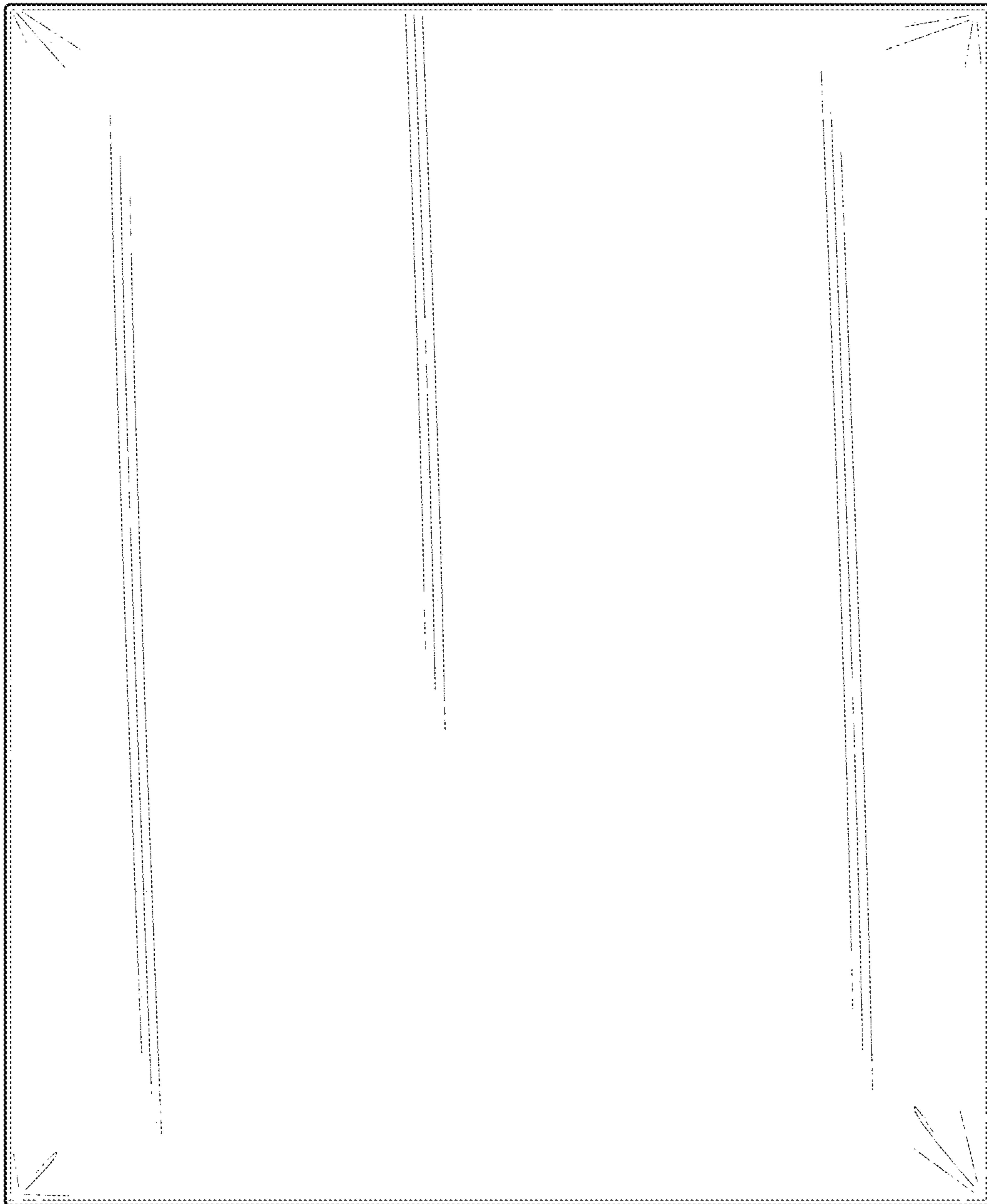

FIG. 17

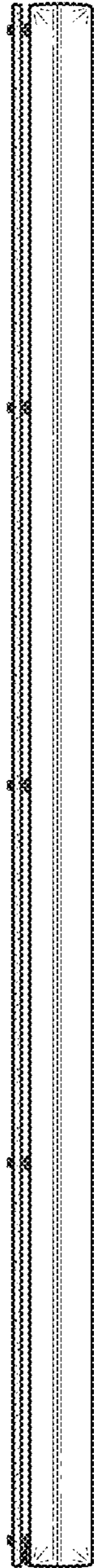

FIG. 18

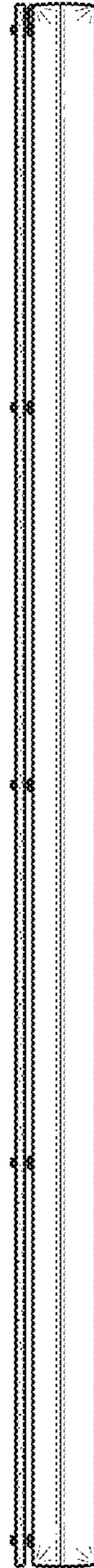

FIG. 19

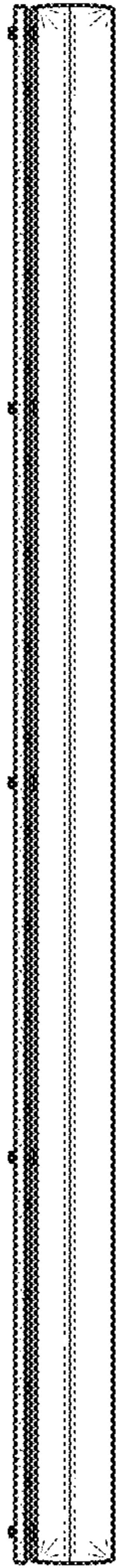

FIG. 20

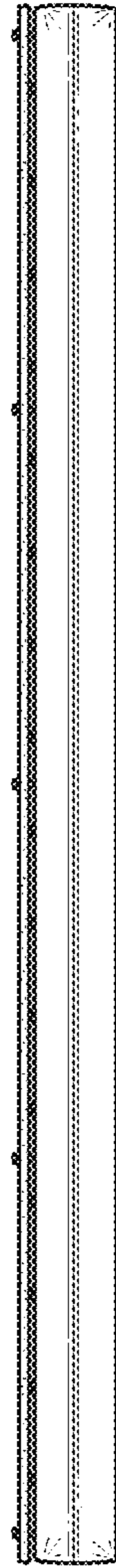

FIG. 21

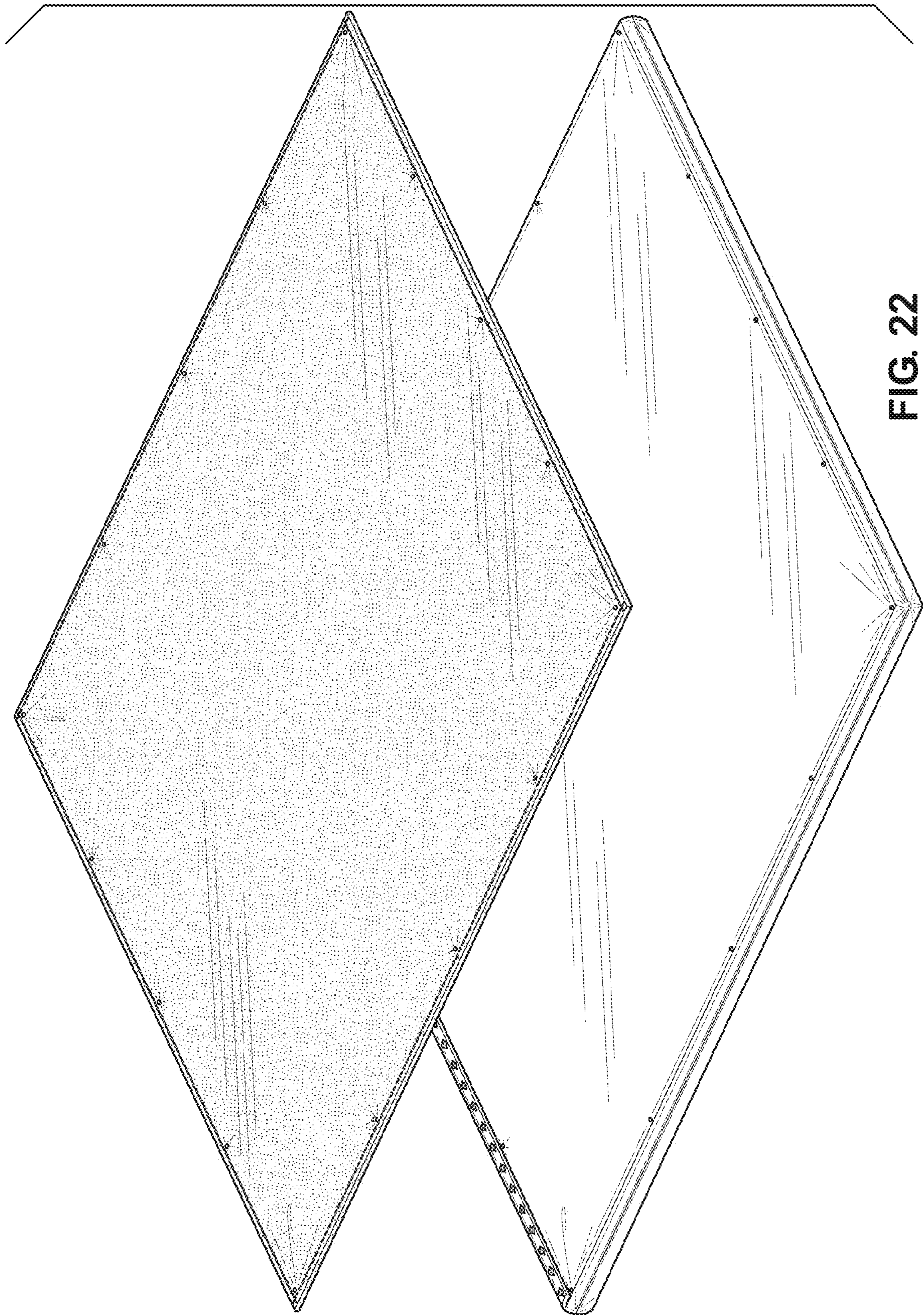

FIG. 22



FIG. 23

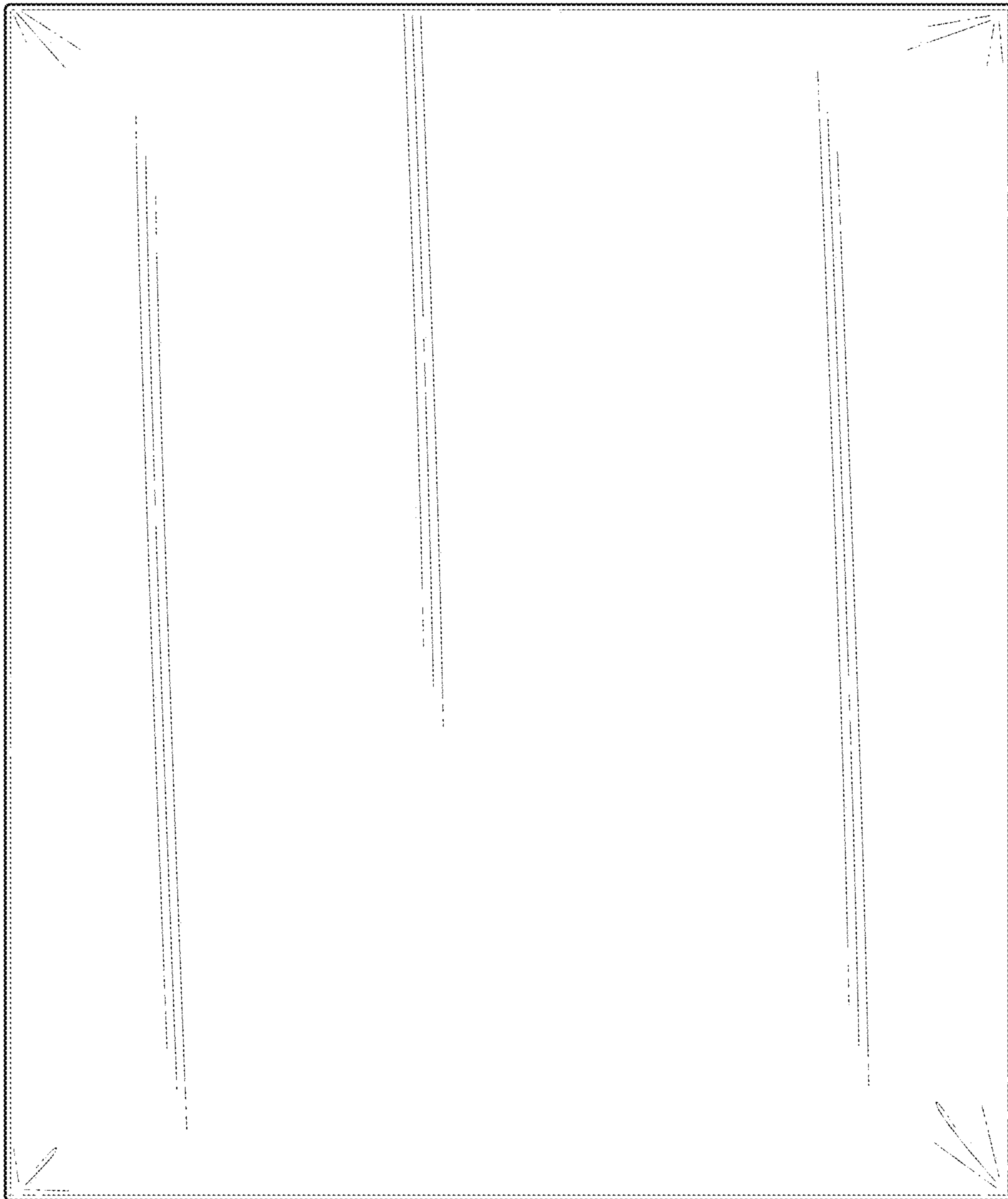

FIG. 24

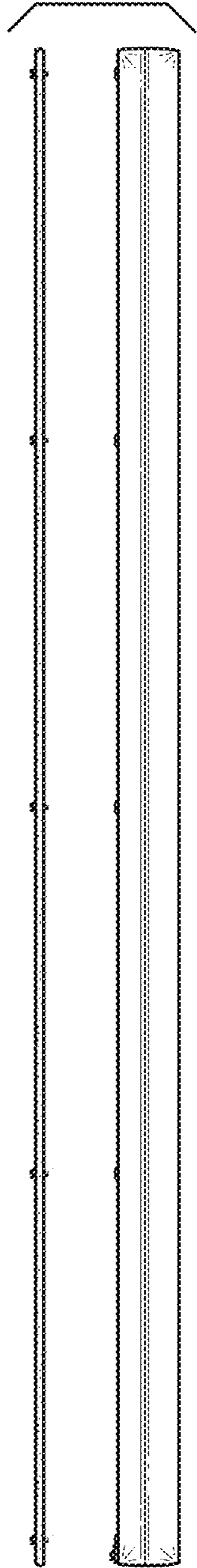

FIG. 25

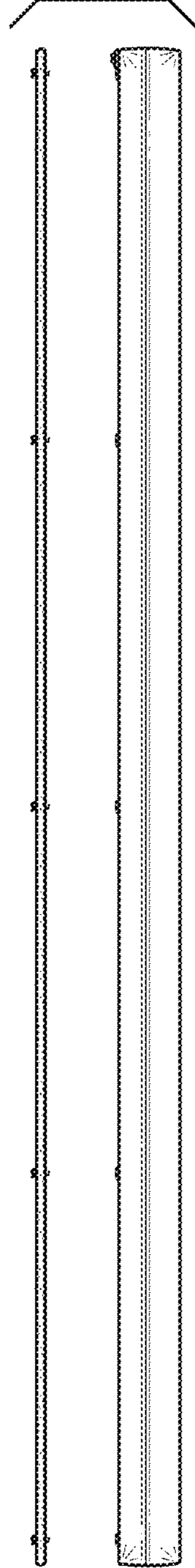

FIG. 26

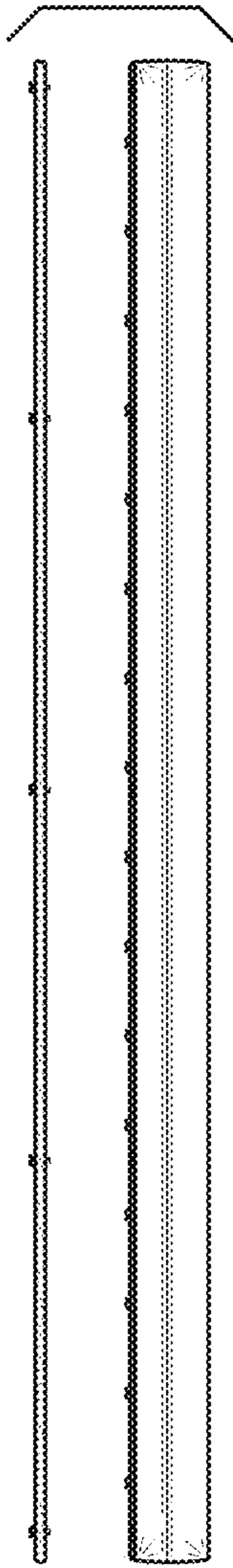

FIG. 27

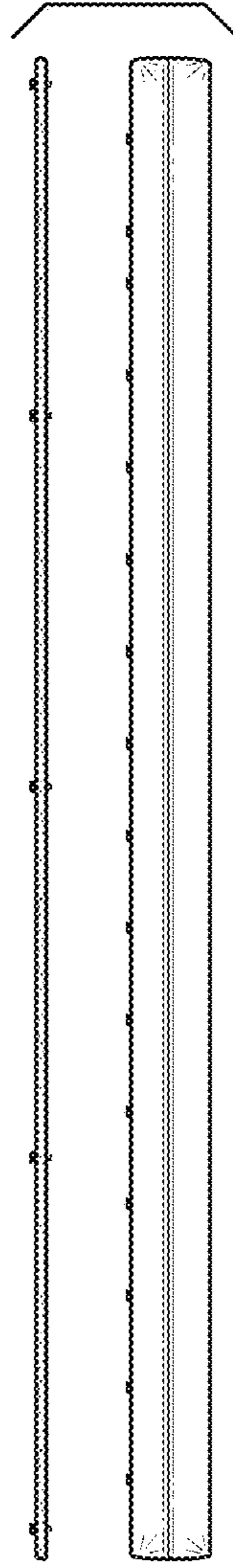

FIG. 28

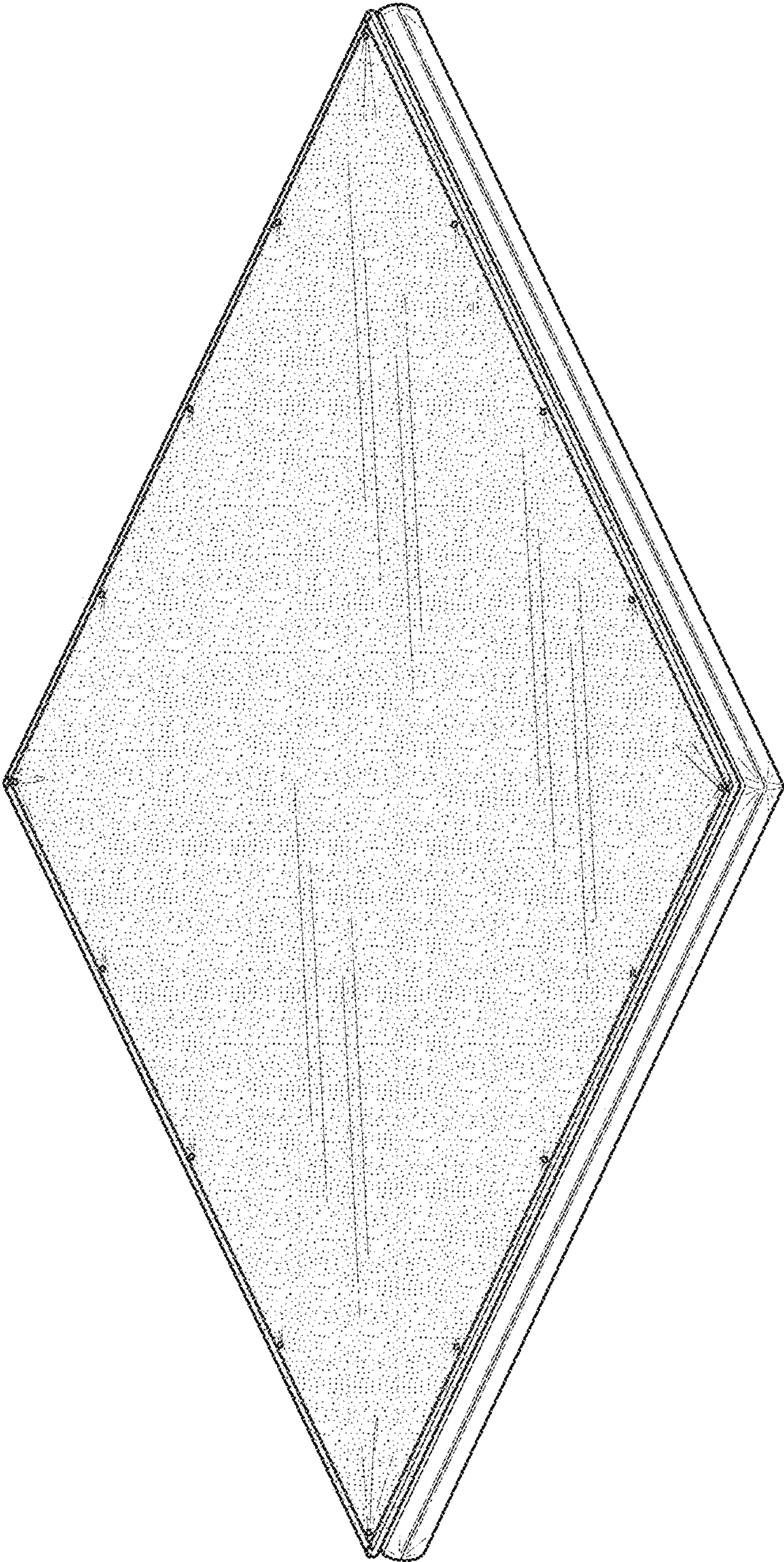

FIG. 29

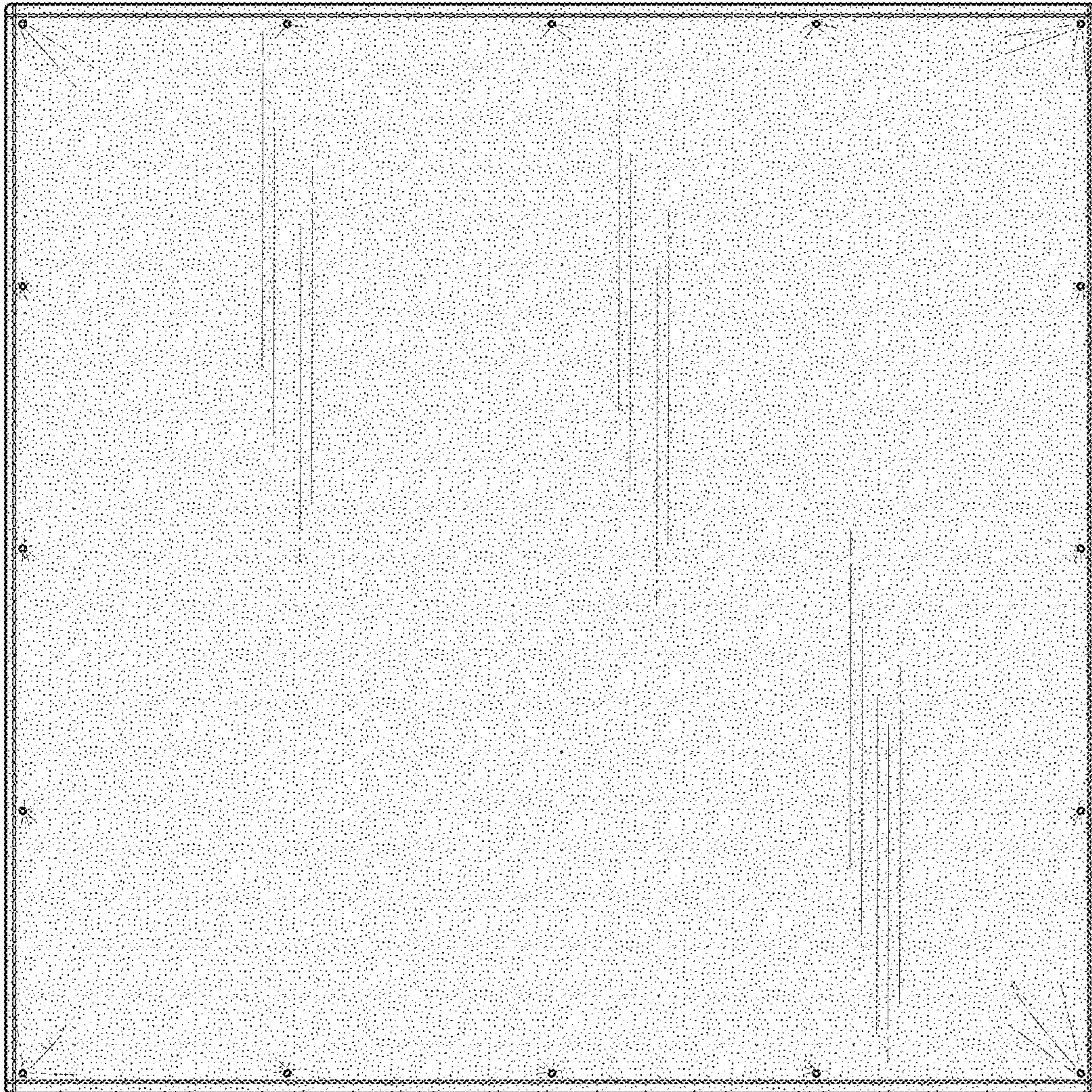

FIG. 30

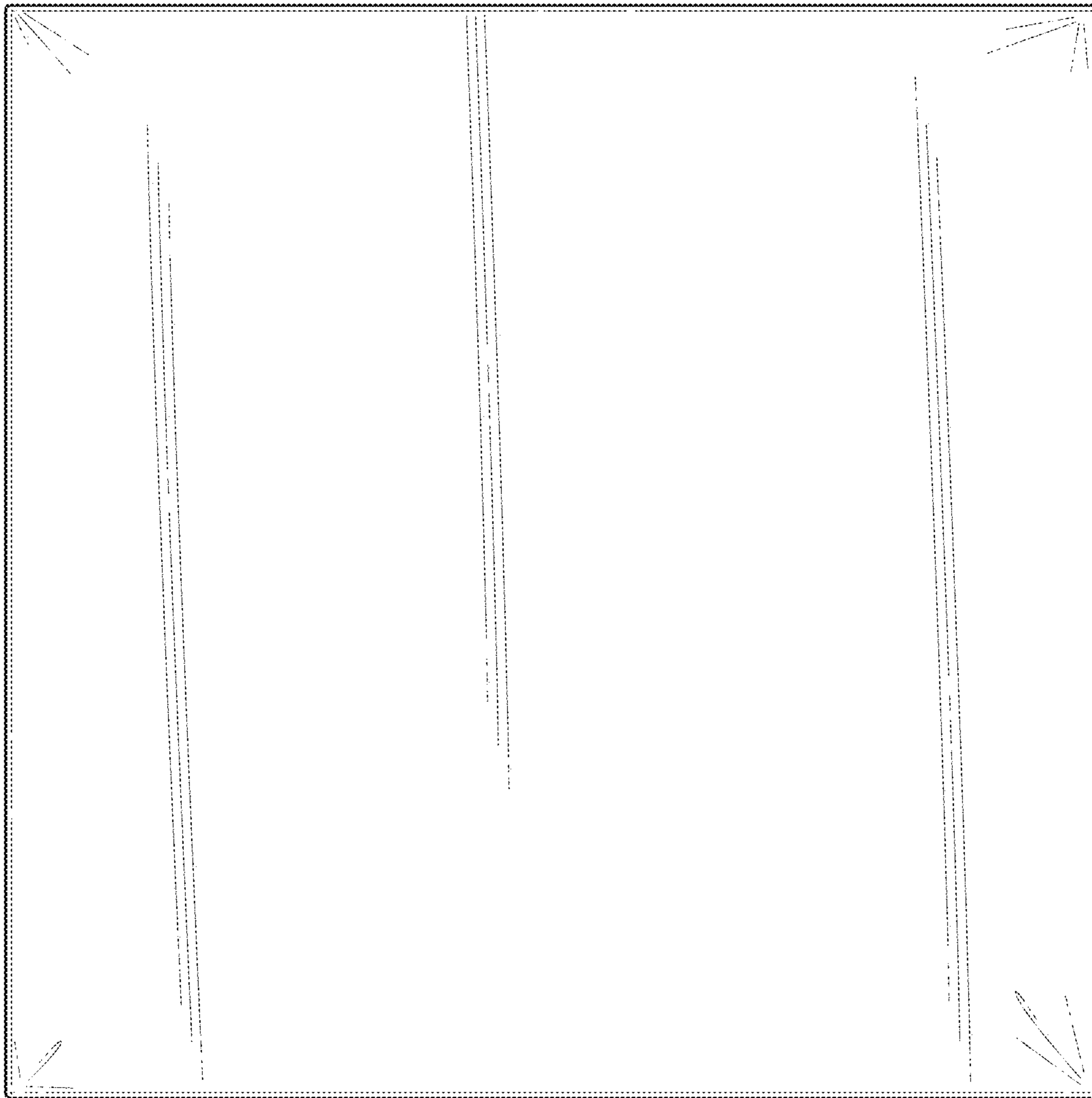

FIG. 31

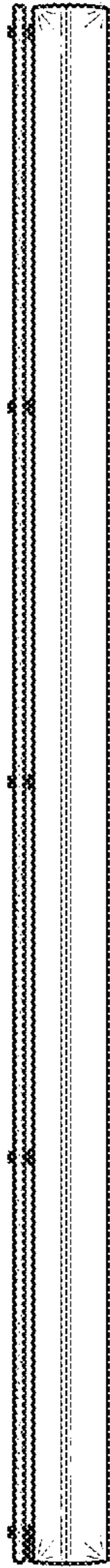

FIG. 32

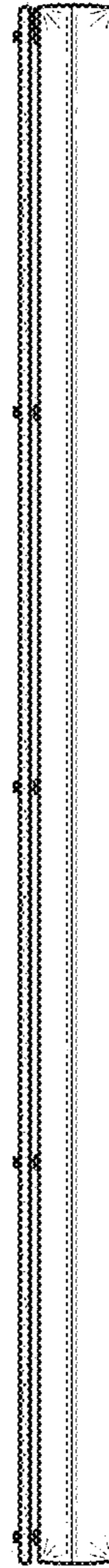

FIG. 33

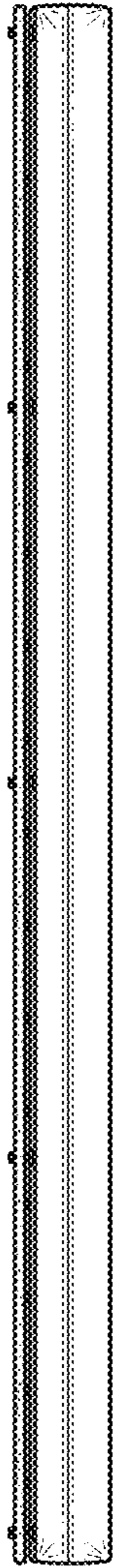

FIG. 34

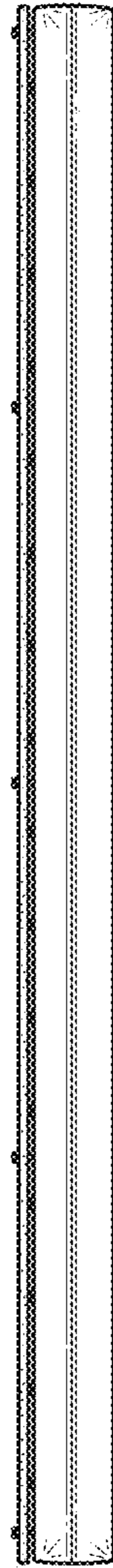

FIG. 35

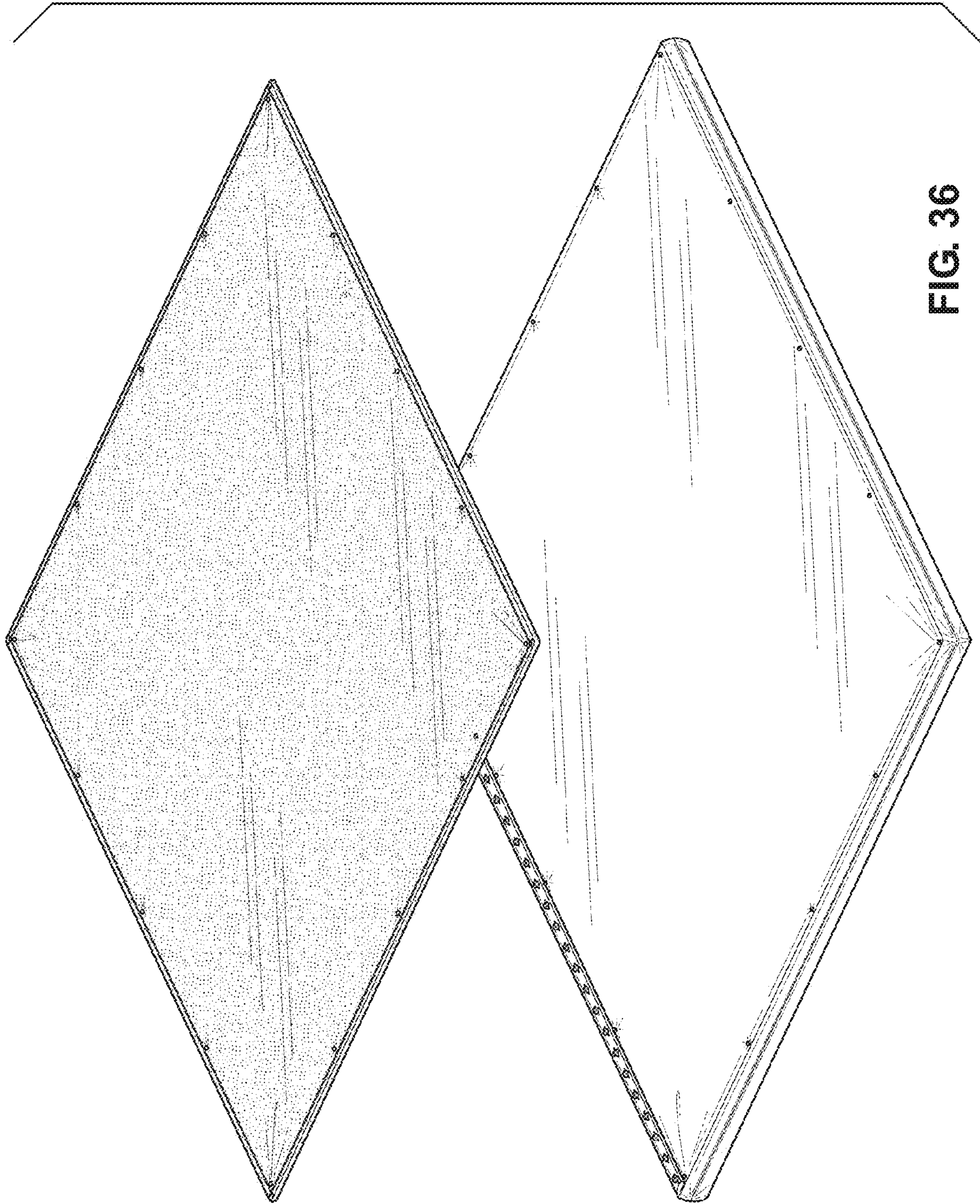

FIG. 36

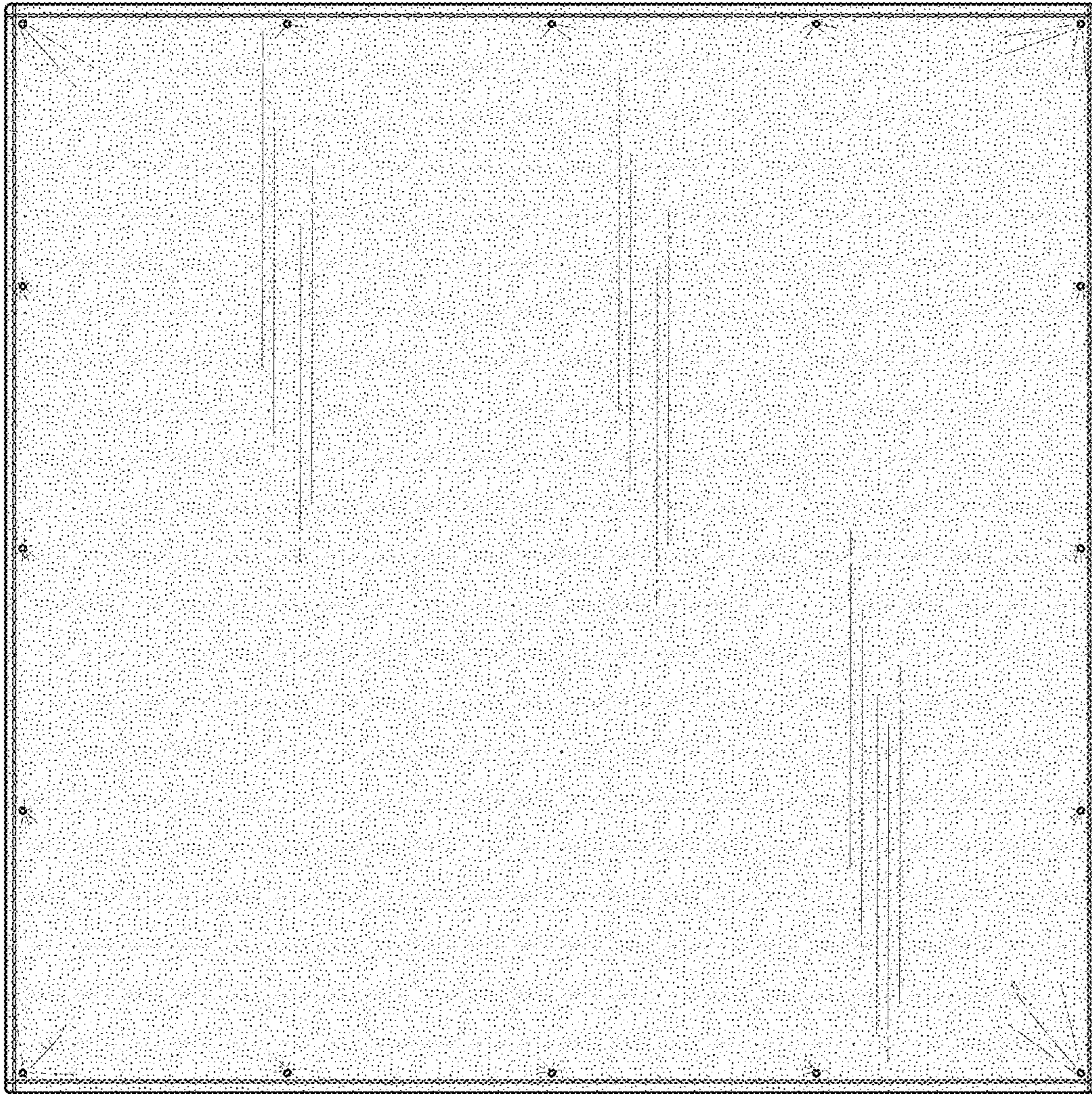

FIG. 37

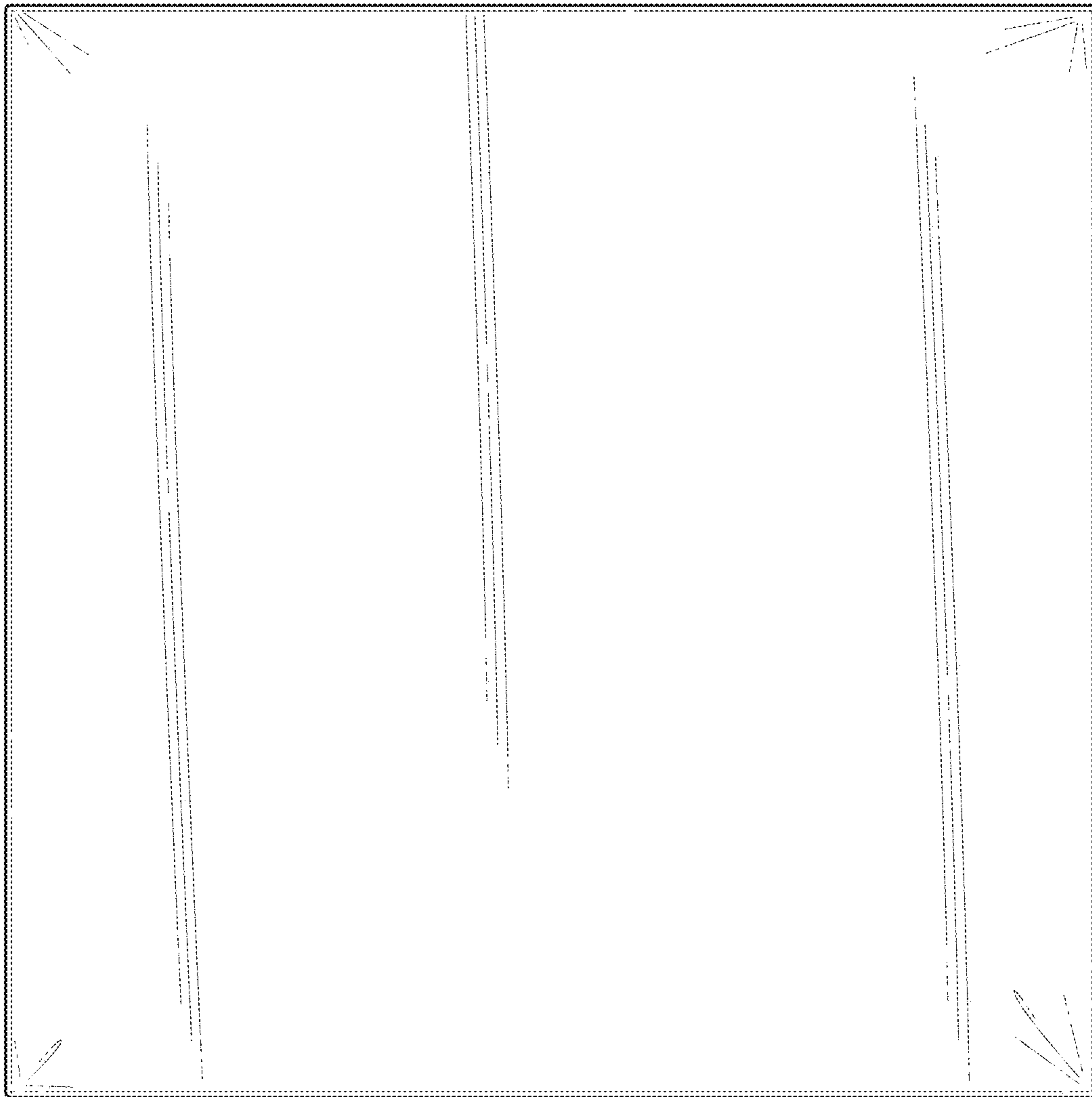

FIG. 38

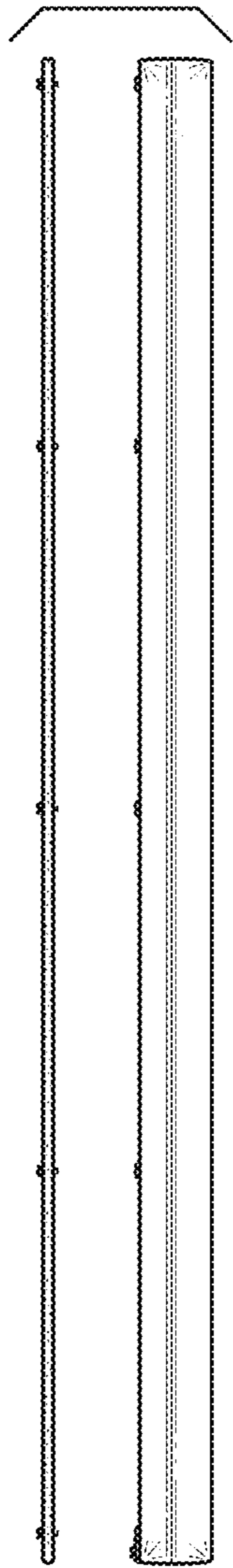

FIG. 39

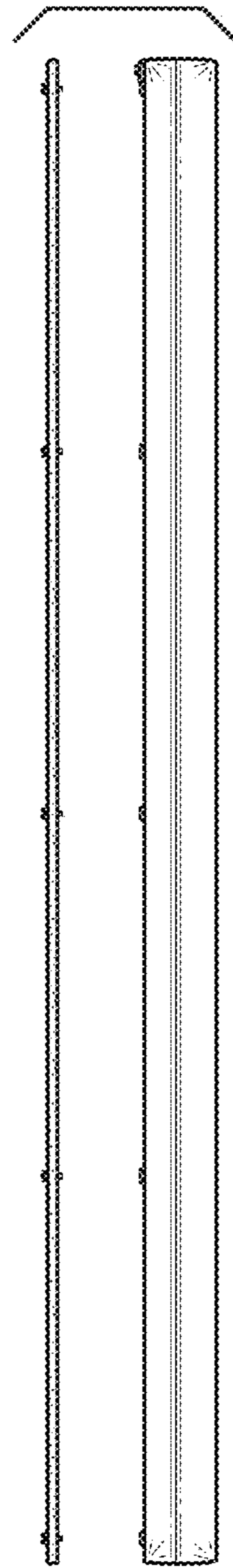

FIG. 40

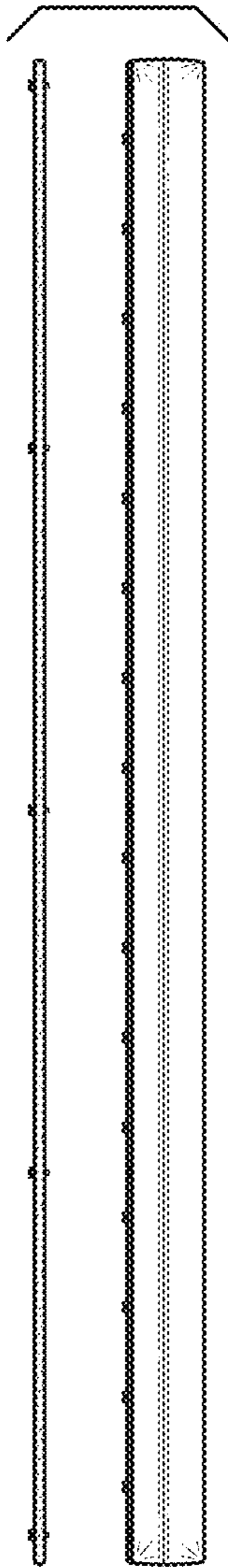

FIG. 41

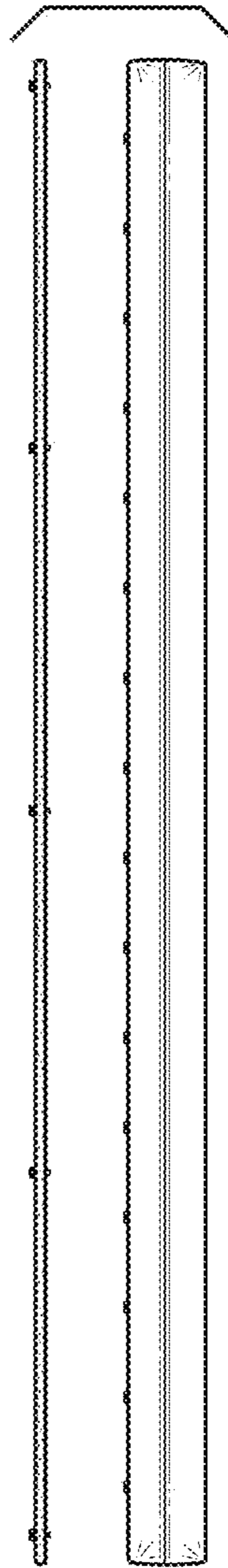

FIG. 42

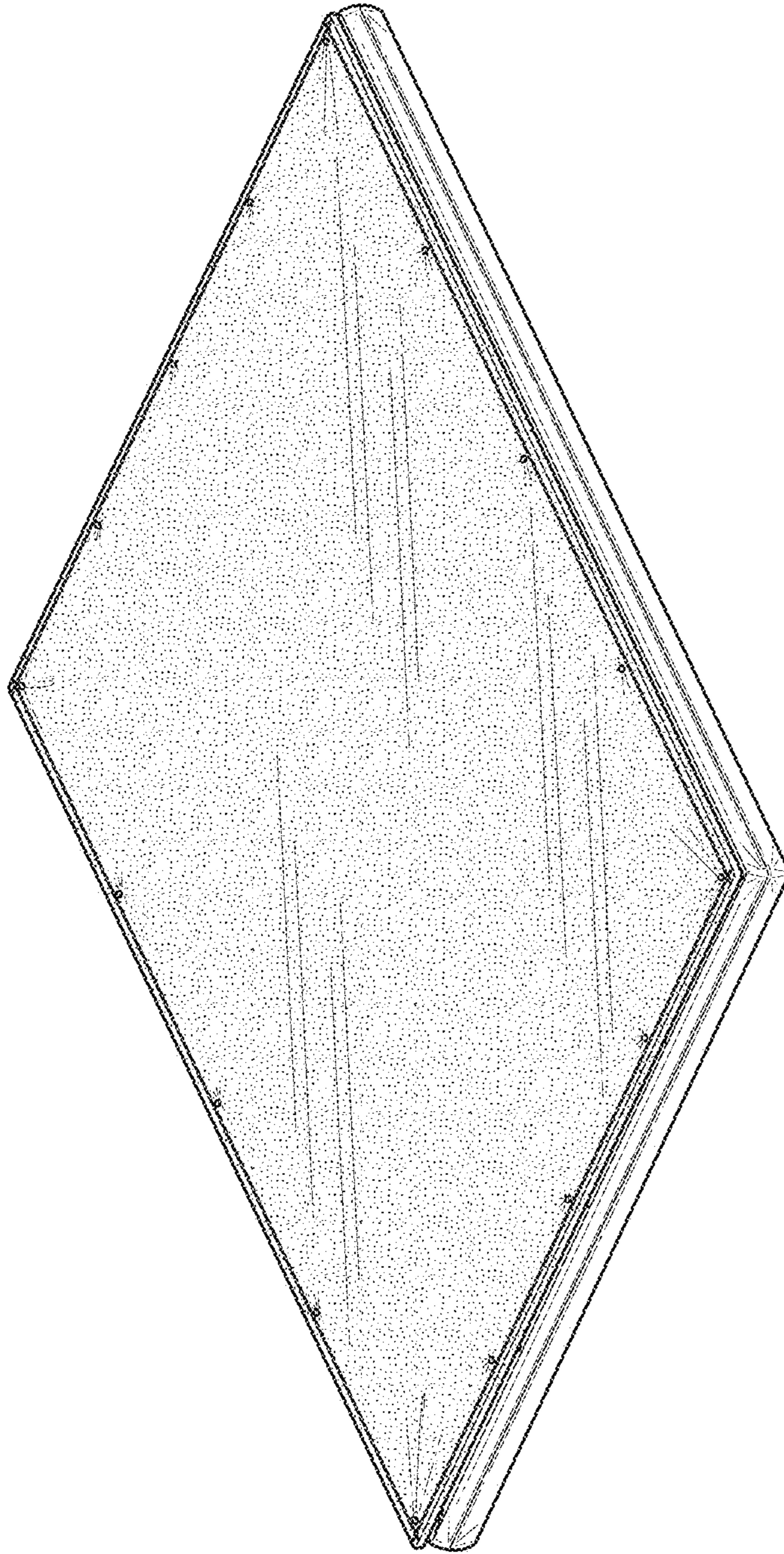

FIG. 43

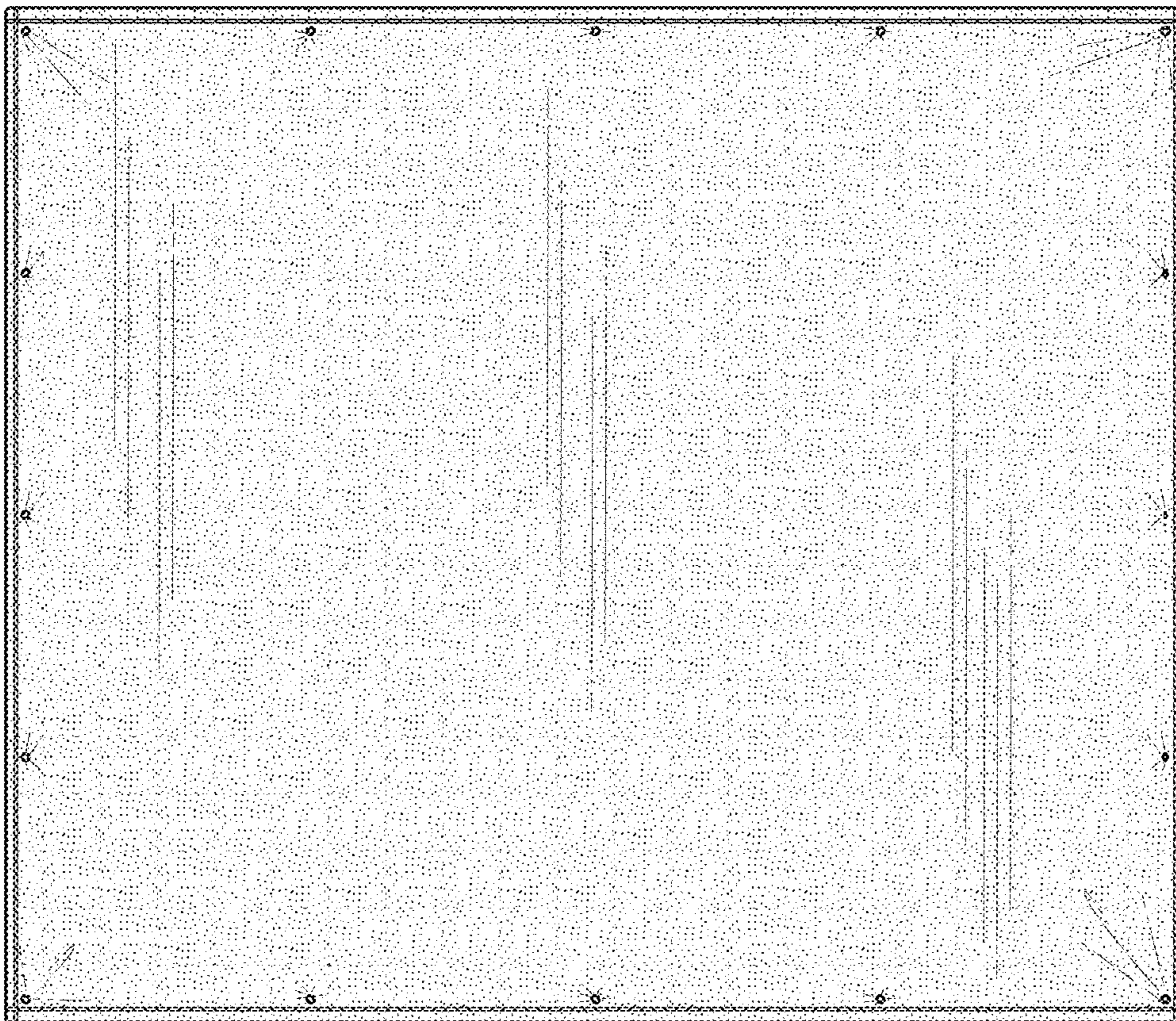

FIG. 44

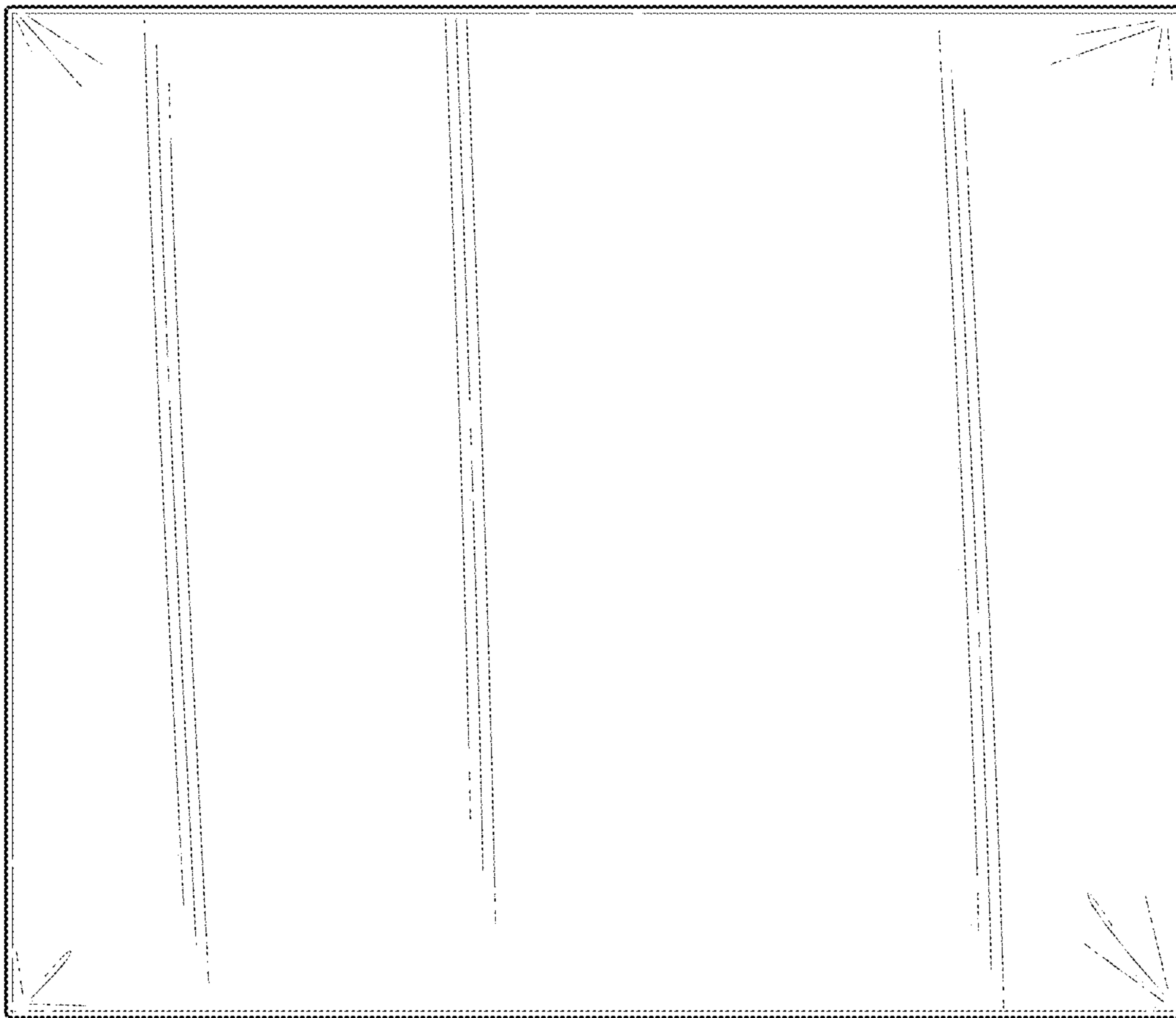

FIG. 45

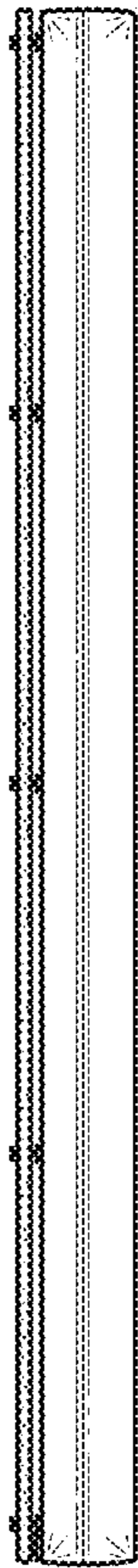

FIG. 46

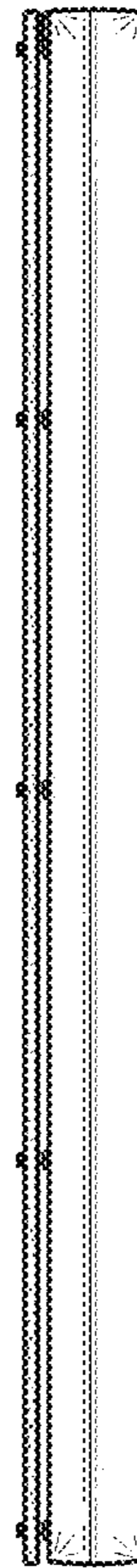

FIG. 47

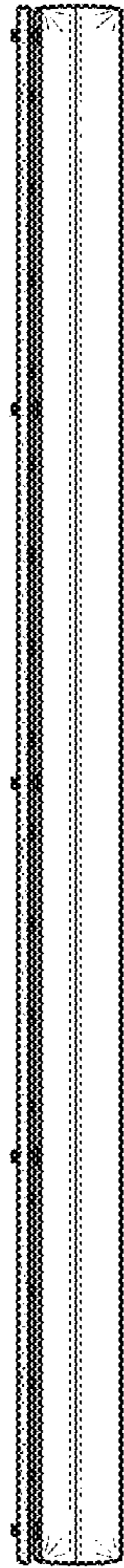

FIG. 48

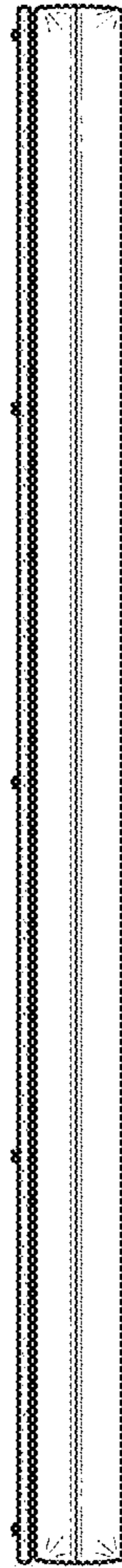

FIG. 49

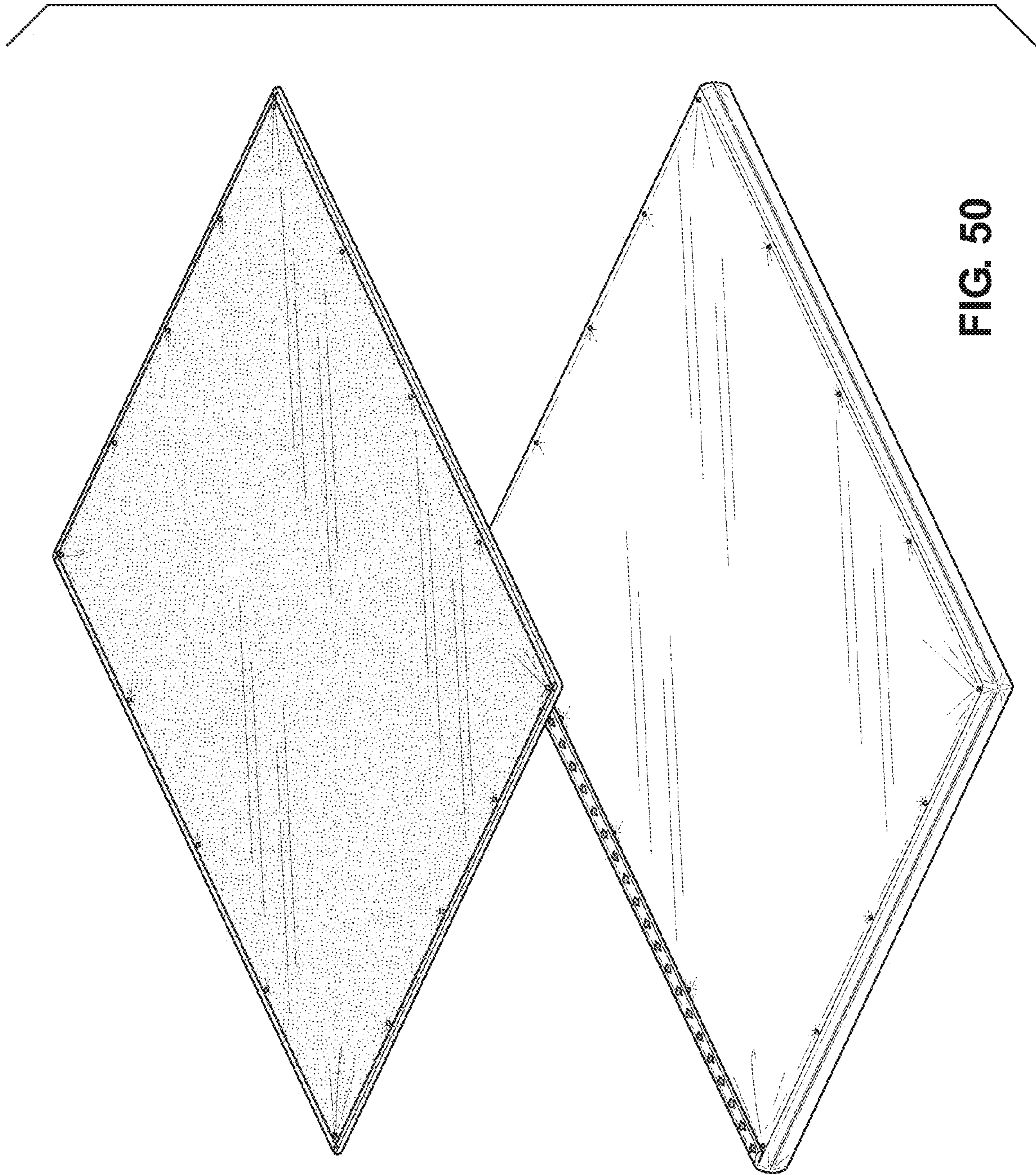

FIG. 50

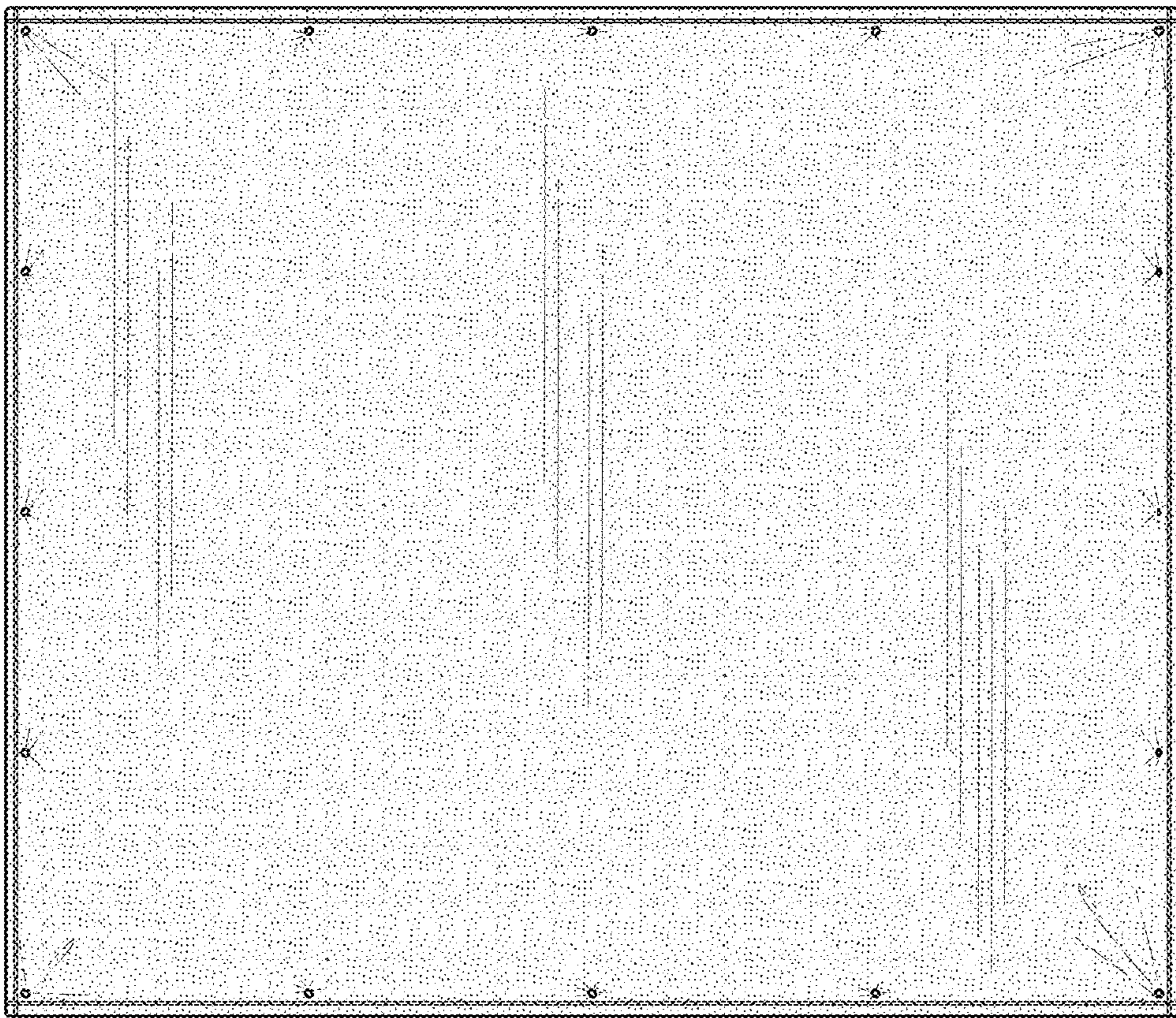

FIG. 51

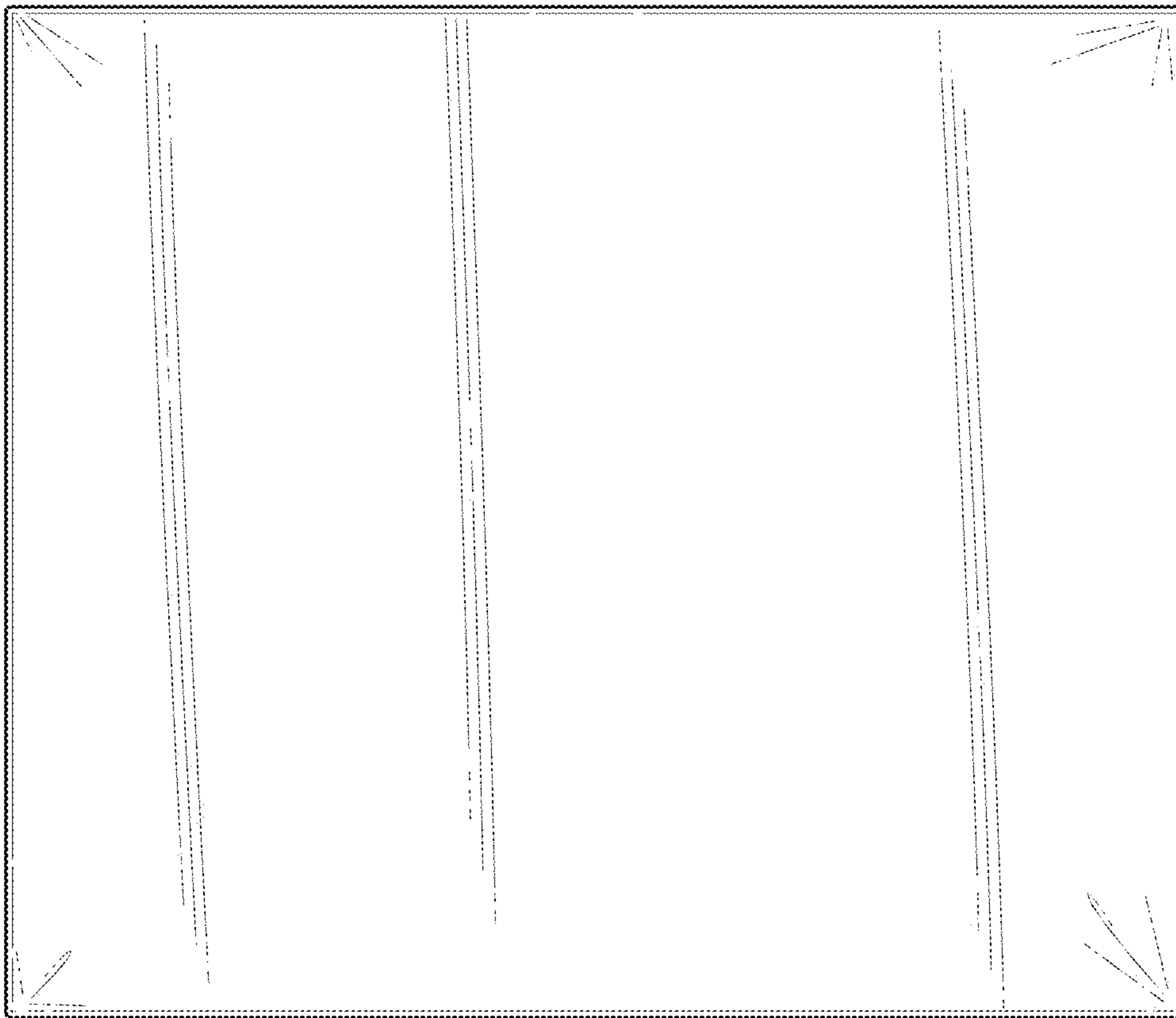

FIG. 52

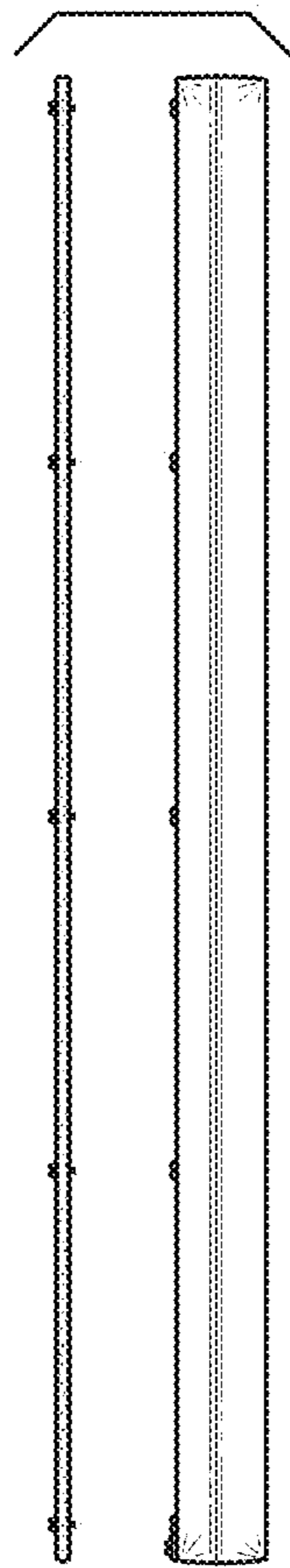

FIG. 53

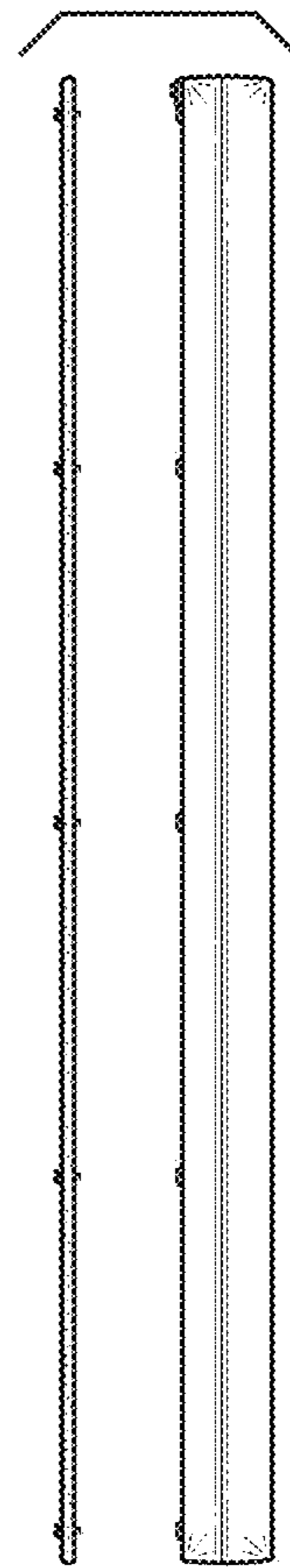

FIG. 54

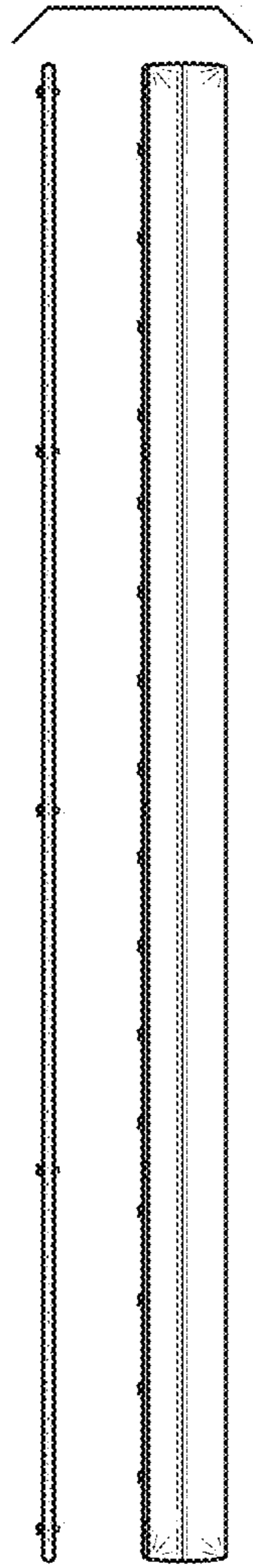

FIG. 55

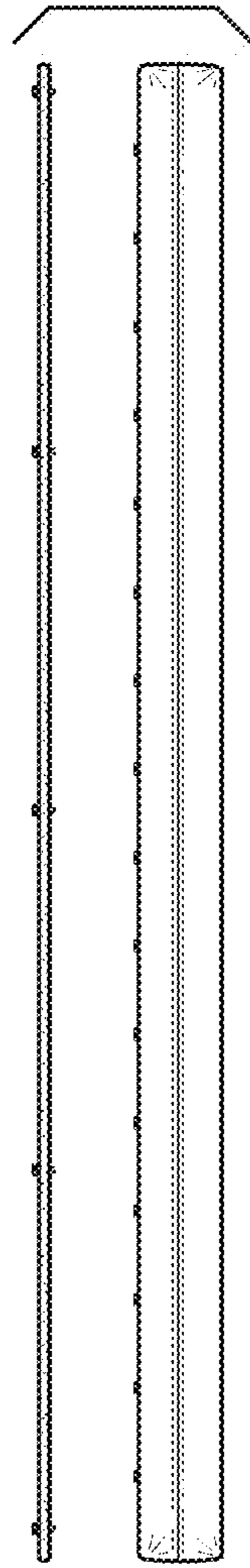

FIG. 56