



US00D985931S

(12) **United States Design Patent**
Jiang

(10) **Patent No.:** **US D985,931 S**

(45) **Date of Patent:** **** *May 16, 2023**

(54) **BACKPACK**

(71) Applicant: **Chunli Jiang**, Anhui (CN)

(72) Inventor: **Chunli Jiang**, Anhui (CN)

(*) Notice: This patent is subject to a terminal disclaimer.

(**) Term: **15 Years**

(21) Appl. No.: **29/802,908**

(22) Filed: **Aug. 9, 2021**

(51) **LOC (14) Cl.** **03-01**

(52) **U.S. Cl.**
USPC **D3/217**

(58) **Field of Classification Search**
USPC D3/233, 321, 216, 217
See application file for complete search history.

(56) **References Cited**

U.S. PATENT DOCUMENTS

6,281,800 B1 *	8/2001	Sizemore	G08B 13/149 340/693.5
D641,973 S	7/2011	Quehl		
D642,791 S	8/2011	Quehl		
D771,373 S *	11/2016	Kim	D3/217
D775,817 S	1/2017	Ridley		
D829,435 S	10/2018	Viger		
D830,053 S	10/2018	Dumas		
D836,334 S *	12/2018	Chung	A45C 13/30 D3/217
D841,318 S *	2/2019	Carter	D3/217
D841,978 S	3/2019	Ou		
D856,662 S	8/2019	Breines		
D883,660 S *	5/2020	He	D3/217

D888,413 S	6/2020	Dai		
D901,876 S *	11/2020	Seip	D3/217
D901,878 S	11/2020	Ji		
D909,049 S *	2/2021	Watson	D30/151
2005/0000995 A1 *	1/2005	Eberle	F41C 33/0209 224/652
2019/0387866 A1 *	12/2019	Cheng	A45C 13/04

OTHER PUBLICATIONS

Ugrace Vinatage Laptop Backpack with USB Charging Port on Amazon, photo review Aug. 18, 2019, viewed by Examiner May 24, 2022. Available at URL: https://www.amazon.com/UGRACE-Backpack-Charging-Resistant-Travelling/dp/B07MFLKD4X/ref=sr_1_1?crd=2M6Y4NXXNWS6D&keywords=backpack%2Bwith%2Bfront%2Bflap%2Bbuckle%2Bclosure&qid=.*

* cited by examiner

Primary Examiner — Jennifer L Watkins

(57) **CLAIM**

The ornamental design for a backpack, as shown and described.

DESCRIPTION

FIG. 1 is a perspective view of a backpack design showing my new design.
FIG. 2 is a front view of the backpack.
FIG. 3 is a rear view of the backpack.
FIG. 4 is a left side view of the backpack.
FIG. 5 is a right side view of the backpack.
FIG. 6 is a top view of the backpack; and,
FIG. 7 is a bottom view of the backpack.
The broken lines in the figures depict stitching and form no part of the claim.

1 Claim, 7 Drawing Sheets

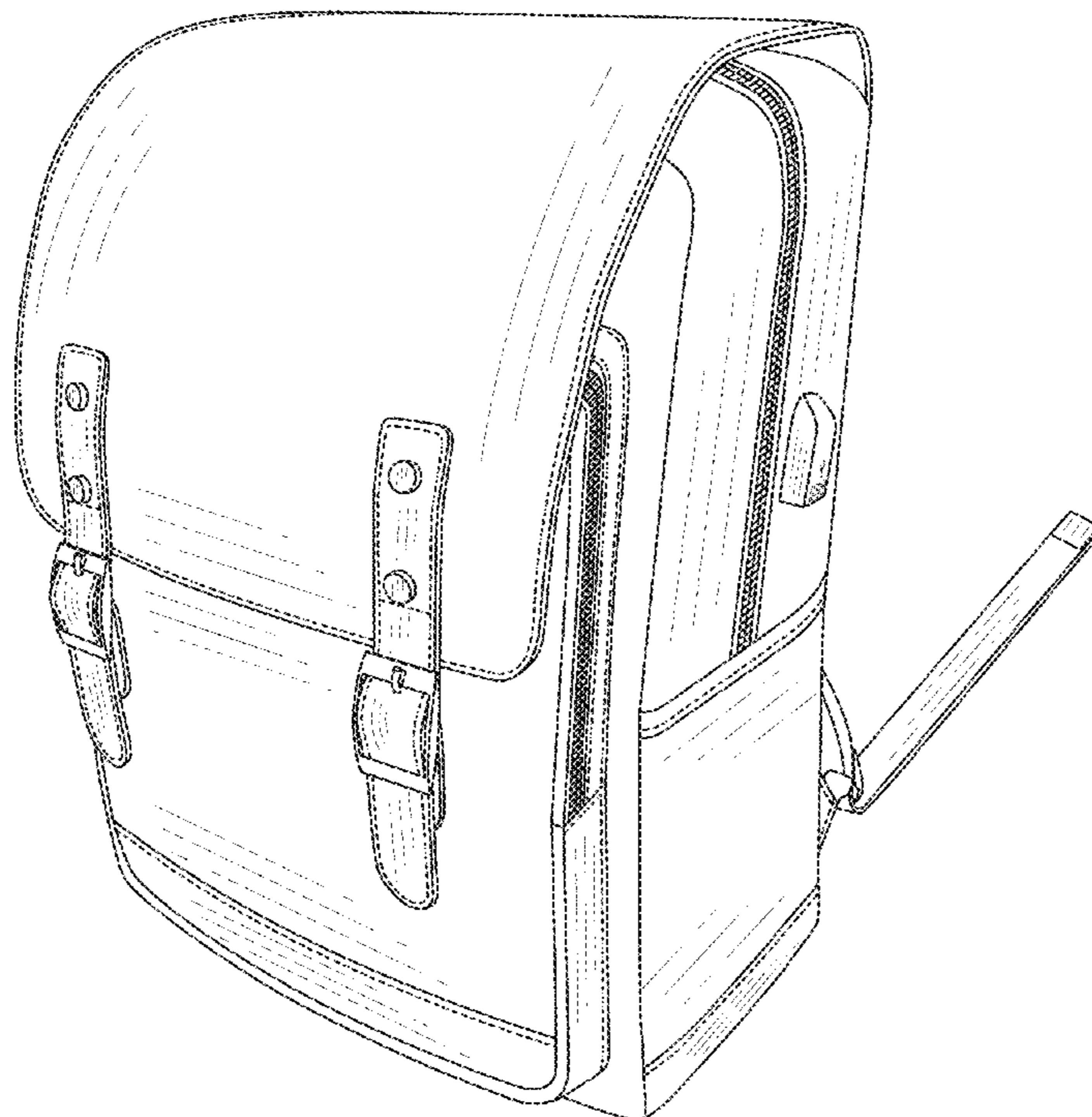



FIG. 1

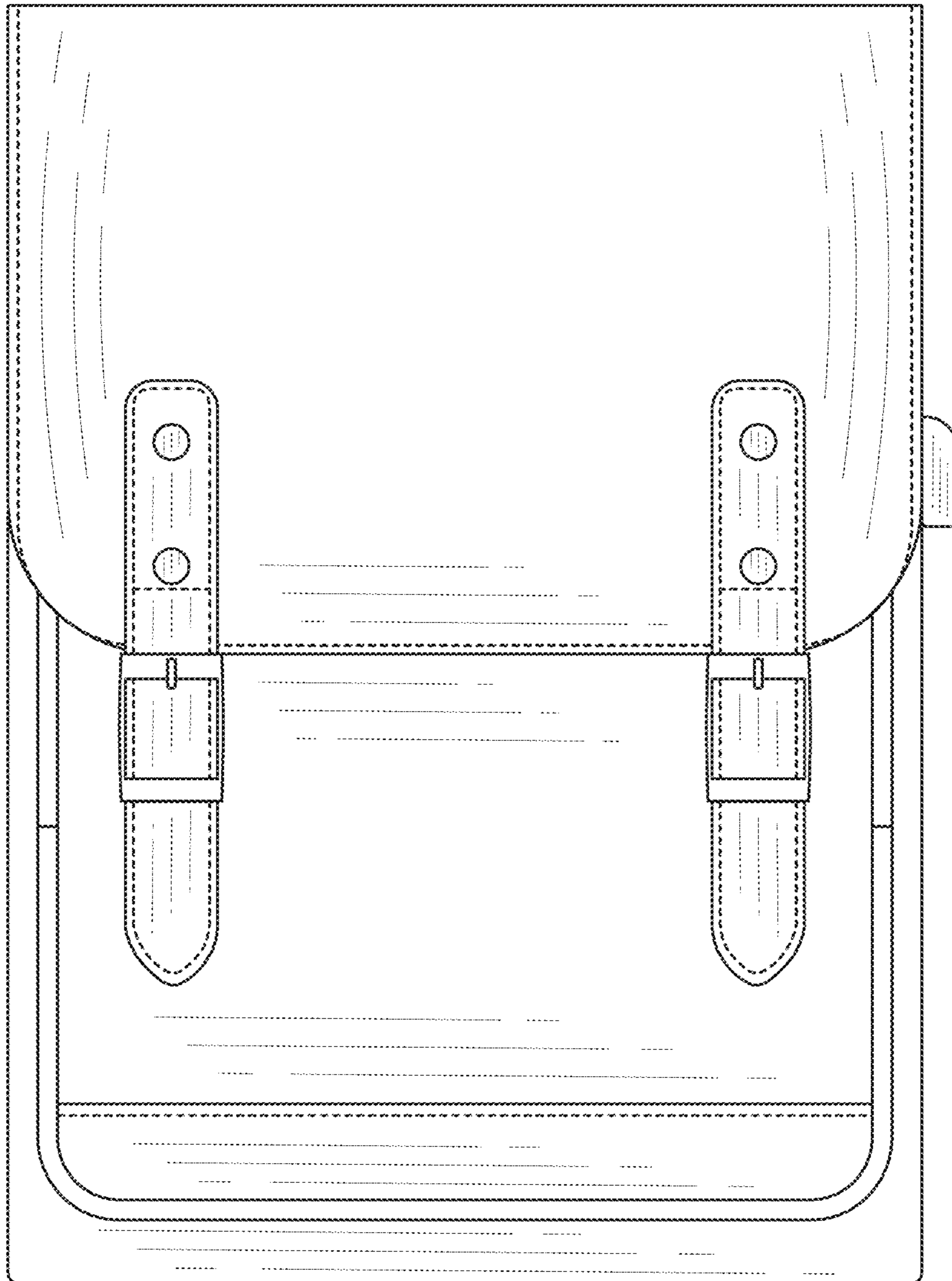

FIG. 2

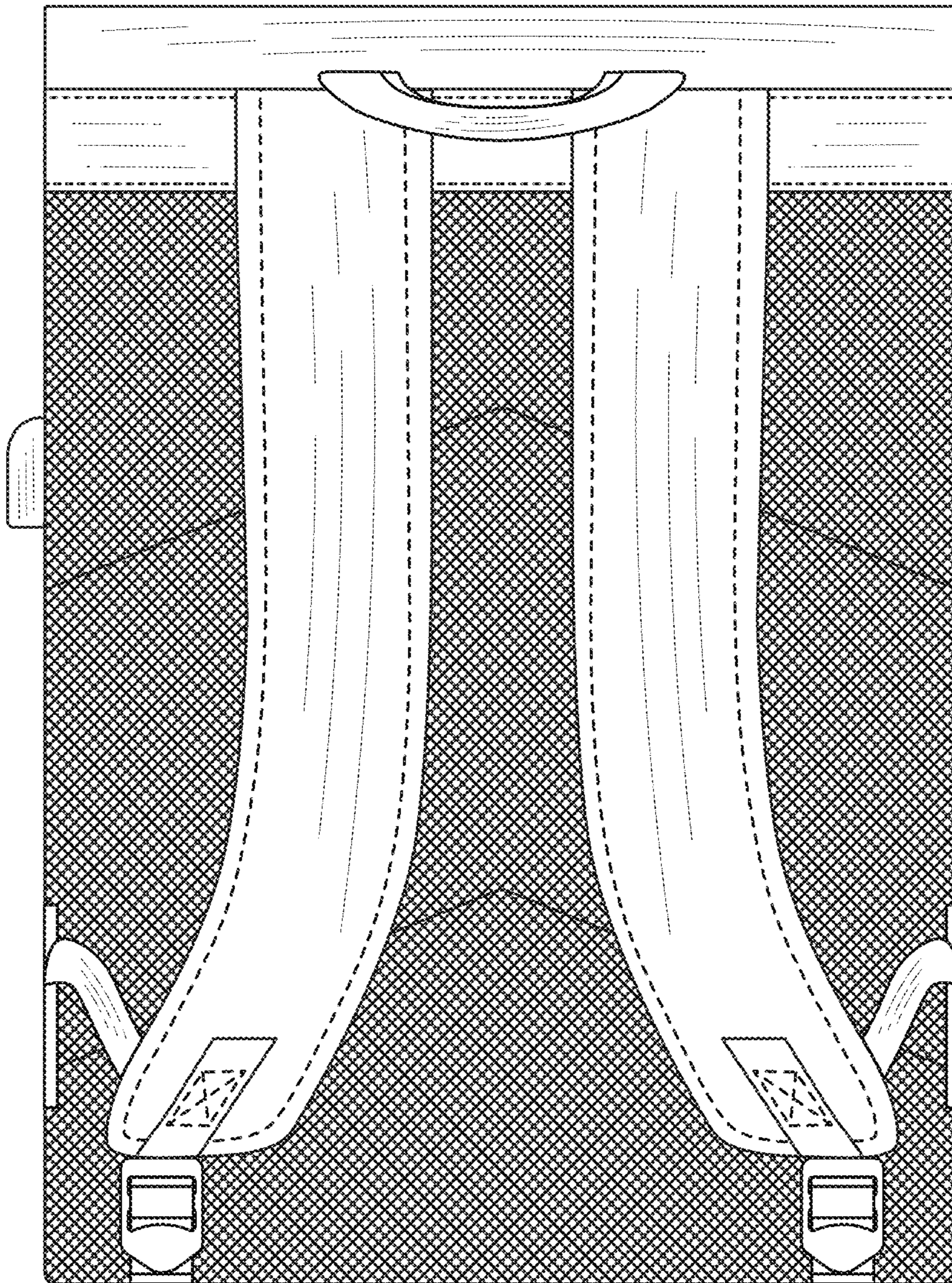

FIG. 3

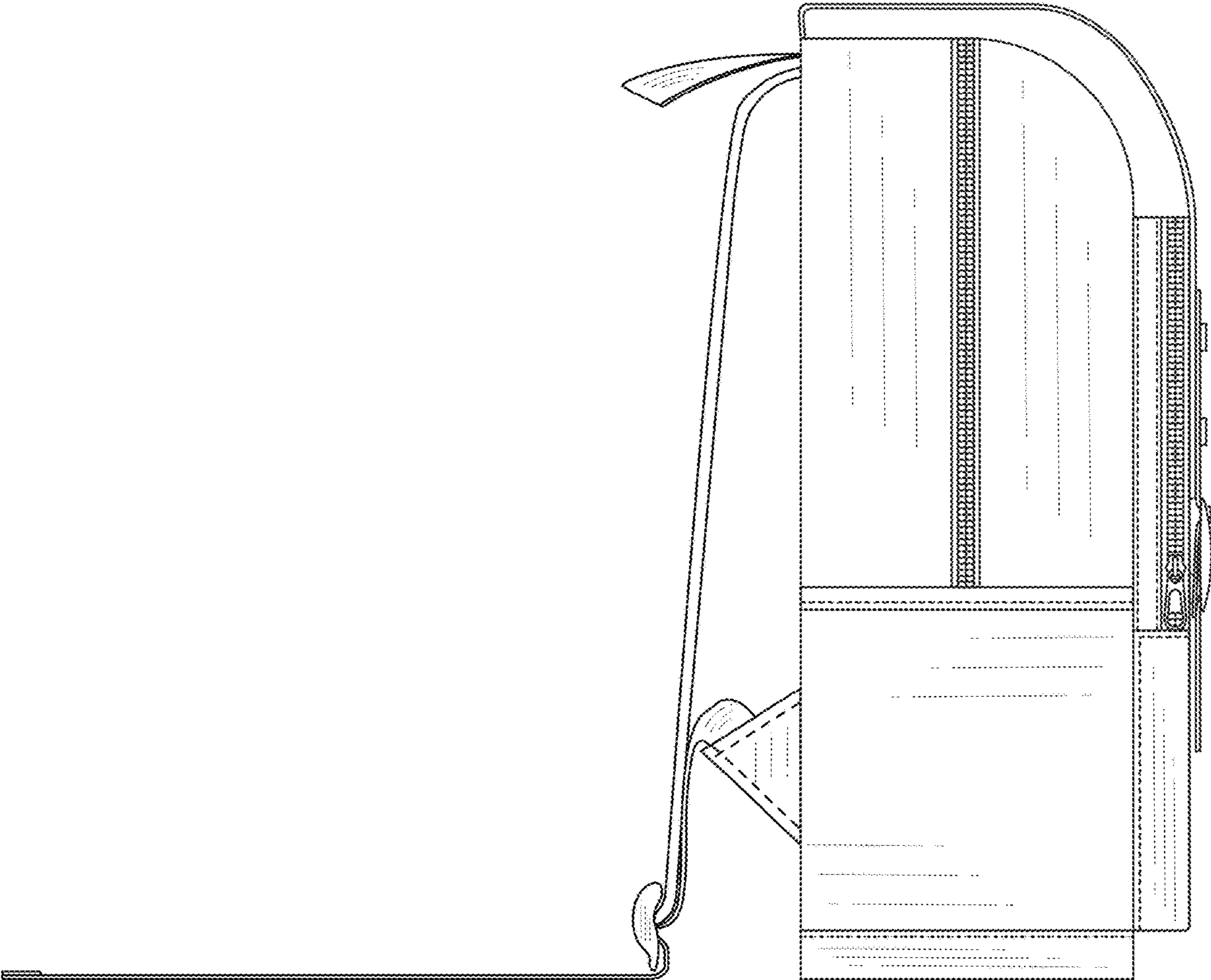

FIG. 4

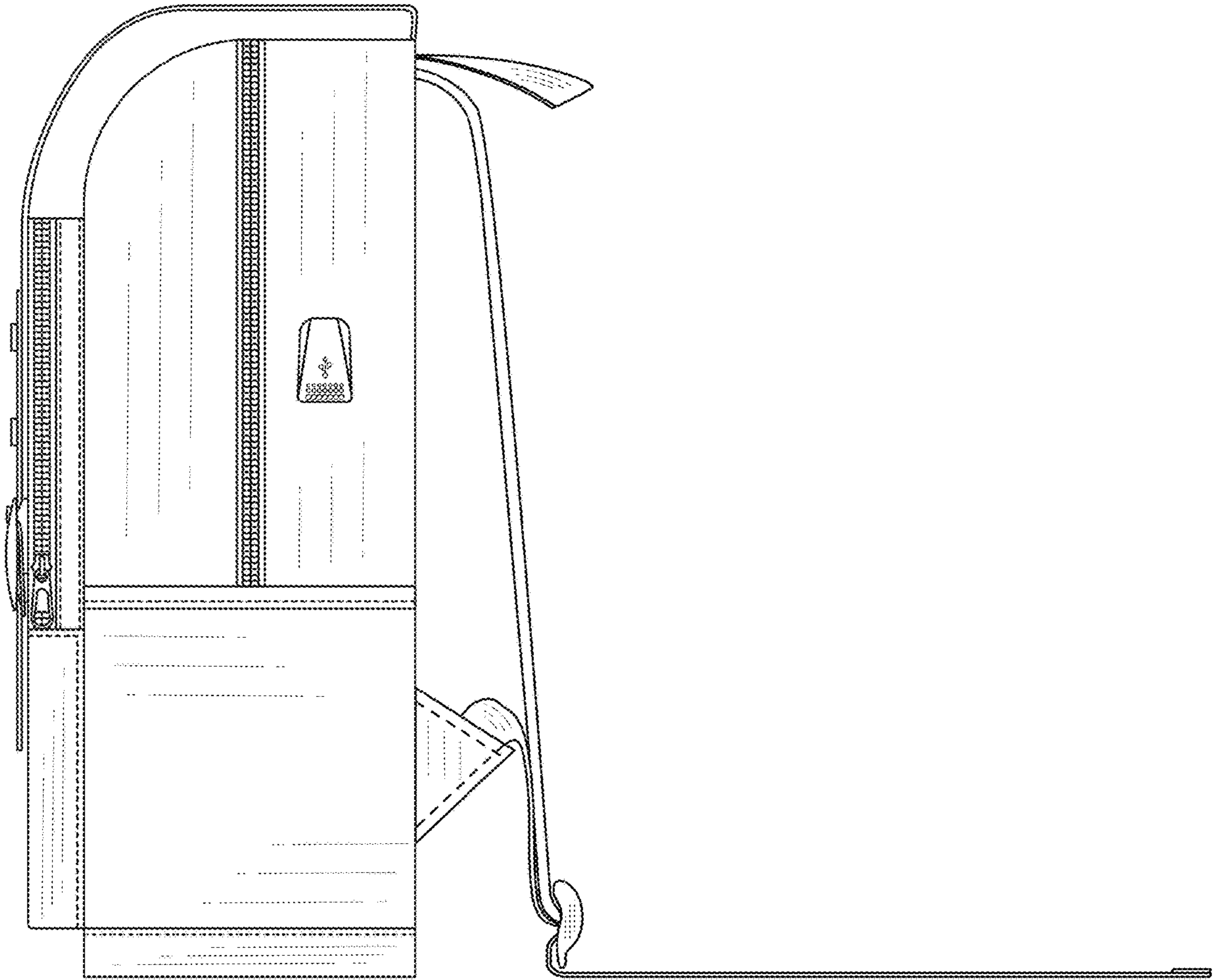

FIG. 5

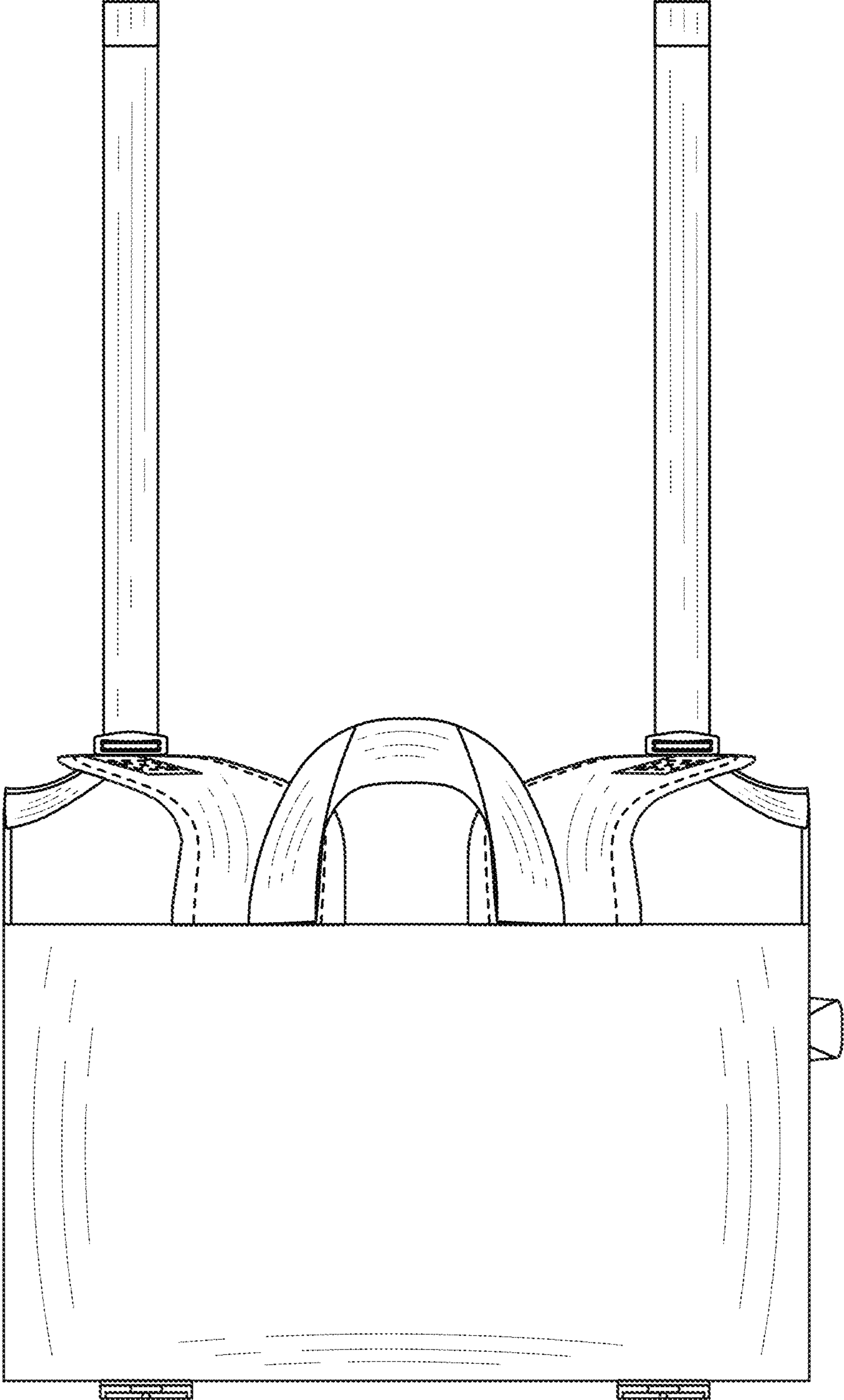

FIG. 6

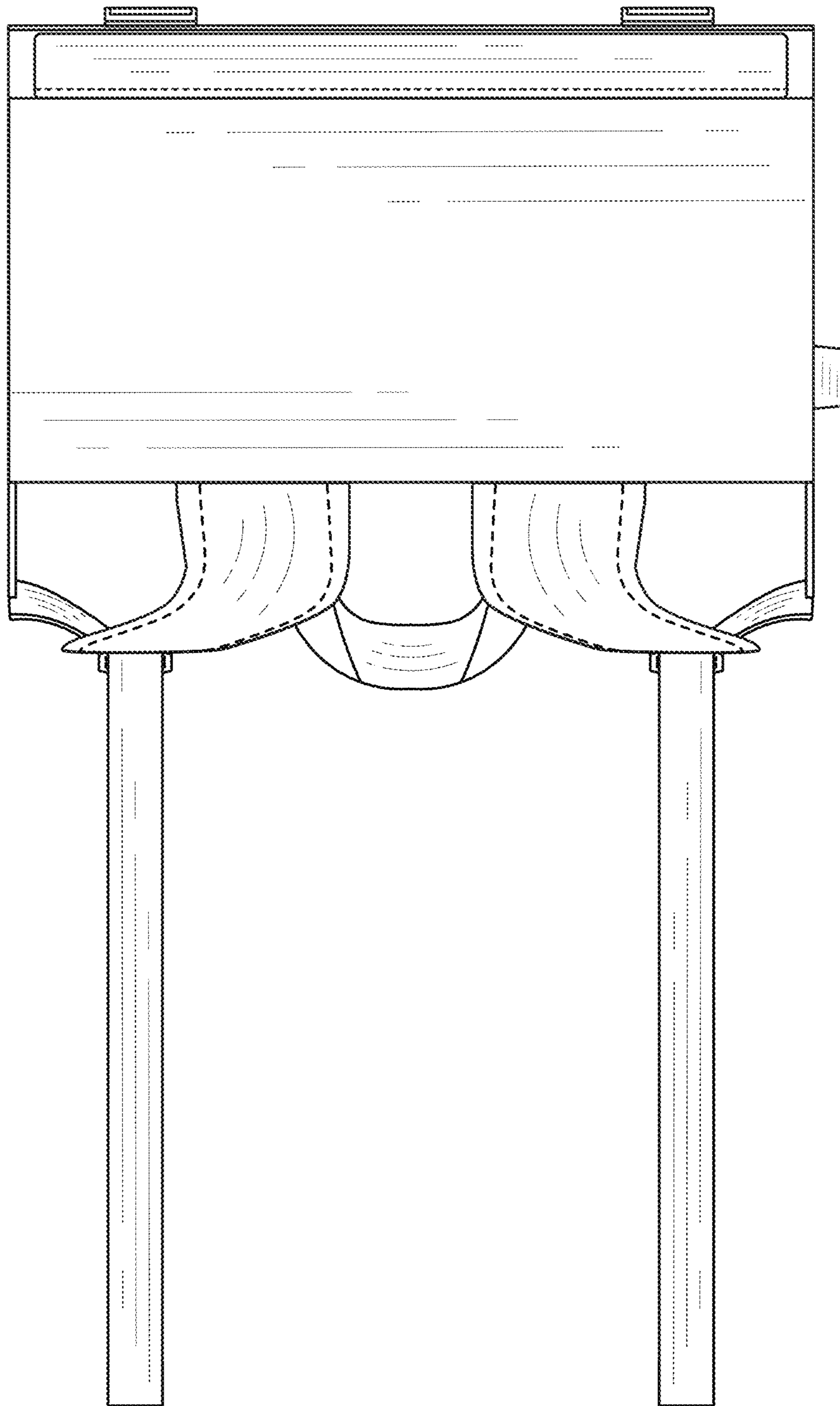

FIG. 7