



US00D985903S

(12) **United States Design Patent**
Cheney et al.

(10) **Patent No.:** **US D985,903 S**

(45) **Date of Patent:** **** May 16, 2023**

(54) **SOLE FOR FOOTWEAR**

(71) Applicant: **FAST IP, LLC**, Vineyard, UT (US)

(72) Inventors: **Craig Cheney**, Lindon, UT (US);
Bradley Johnson, Millcreek, UT (US)

(73) Assignee: **FAST IP, LLC**, Lindon, UT (US)

(**) Term: **15 Years**

(21) Appl. No.: **29/779,357**

(22) Filed: **Apr. 19, 2021**

(51) **LOC (14) Cl.** **02-04**

(52) **U.S. Cl.**
USPC **D2/947; D2/972**

(58) **Field of Classification Search**
USPC D2/896, 900, 902, 904, 906–908,
D2/916–924, 925–946, 968–979, 947–962
CPC A43B 1/00; A43B 1/02; A43B 1/04; A43B
3/00; A43B 3/02; A43B 3/06; A43B 3/10;
A43B 3/12; A43B 3/14; A43B 5/00;
A43B 5/001; A43B 5/002; A43B 5/008;
A43B 5/06; A43B 5/10; A43B 5/12;
A43B 23/00; A43B 23/02; A43B 23/04
See application file for complete search history.

(56) **References Cited**

U.S. PATENT DOCUMENTS

D401,744 S * 12/1998 Greenberg D2/960
D432,777 S * 10/2000 Lotti D2/972
D707,928 S * 7/2014 Castellon D2/947
D717,527 S * 11/2014 Truelsen D2/951
D741,586 S * 10/2015 Truelsen D2/951
D746,561 S * 1/2016 Bikowski D2/951
9,820,527 B2 * 11/2017 Pratt A43B 11/00
D838,463 S * 1/2019 Durflinger D2/947
D840,663 S * 2/2019 Flanagan A43B 11/00
D2/972
D854,303 S * 7/2019 Flanagan A43B 11/00
D2/972
10,455,898 B1 * 10/2019 Grand A43C 11/004

10,638,810 B1 * 5/2020 Cheney A43B 3/248
D909,721 S * 2/2021 Toelle D2/947
D909,738 S * 2/2021 Toelle D2/947
D909,739 S * 2/2021 Toelle D2/947
10,905,192 B1 * 2/2021 Cheney A43B 3/246
11,064,761 B2 * 7/2021 Cheney A43B 11/00
D932,171 S * 10/2021 Figur D2/947
11,191,321 B2 * 12/2021 Kilgore A43B 11/00
D943,894 S * 2/2022 Jury D2/947
D943,904 S * 2/2022 Giard D2/947
D959,803 S * 8/2022 Lv D2/947
D965,265 S * 10/2022 Kanata D2/947

(Continued)

OTHER PUBLICATIONS

Kizik Roamer, KicksOnFire.com, [online], [site visited Jan. 10, 2023]. <URL: <https://www.kicksonfire.com/kizik-roamer/>> (Year: 2022).*

(Continued)

Primary Examiner — Jonathan J Han
Assistant Examiner — Molly K. Orzechowski

(57) **CLAIM**

We claim the ornamental design of a sole for footwear, as shown and described.

DESCRIPTION

FIG. 1 is a side perspective view of a sole for footwear;
FIG. 2 is a second side perspective view thereof;
FIG. 3 is a side view thereof;
FIG. 4 is a front view thereof;
FIG. 5 is a second side view thereof;
FIG. 6 is a rear view thereof; and,
FIG. 7 is a top view thereof.
The broken lines showing the remainder of the shoe are for environmental purposes only, and form no part of the claimed design.

1 Claim, 7 Drawing Sheets

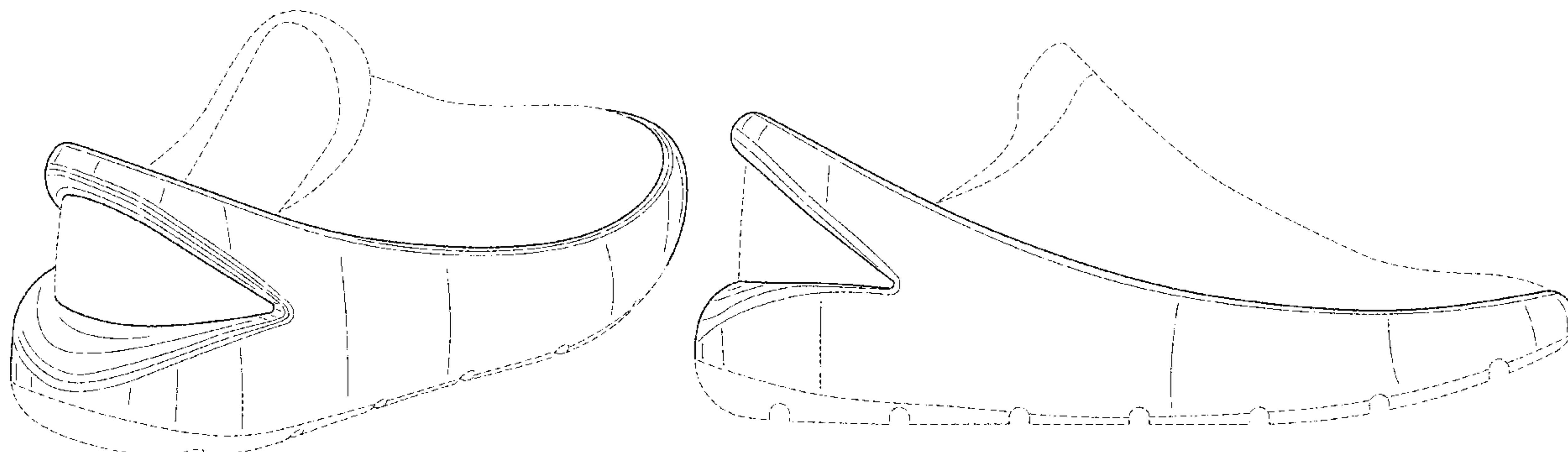

(56)

References Cited

U.S. PATENT DOCUMENTS

D970,188 S * 11/2022 Han D2/947
11,490,680 B2 * 11/2022 Cheney A43B 11/00
D974,716 S * 1/2023 Hoang D2/947
2009/0090025 A1 * 4/2009 Cassidy A43B 21/28
36/35 B
2014/0230284 A1 * 8/2014 Craig A43B 3/0052
36/103
2018/0110292 A1 * 4/2018 Beers A43B 11/00
2020/0345098 A1 * 11/2020 Xanthos A43C 11/006
2021/0112914 A1 * 4/2021 Cheney A43B 23/027
2021/0112916 A1 * 4/2021 Schulten A43B 23/08

OTHER PUBLICATIONS

Nike Jordan System 23 Clog, SneakerNews.com, [online], [site visited Jan. 10, 2023]. <URL: <https://sneakernews.com/2022/08/12/tropical-multi-colors-appear-on-the-jordan-system-23-clog/>> (Year: 2022).*

Nike "Hands-Free" FlyEase Sneakers, [online], [site visited Jan. 10, 2023]. <URL: <https://www.inverse.com/input/style/nike-flyease-hands-free-kids-sneakers-shoes-clothes-release-date-price>> (Year: 2022).*

Nike GO FlyEase, HypeBeast.com, [online], [site visited Jan. 10, 2023]. <URL: <https://hypebeast.com/2021/2/nike-go-flyease-hands-free-sneaker-details>> (Year: 2021).*

* cited by examiner

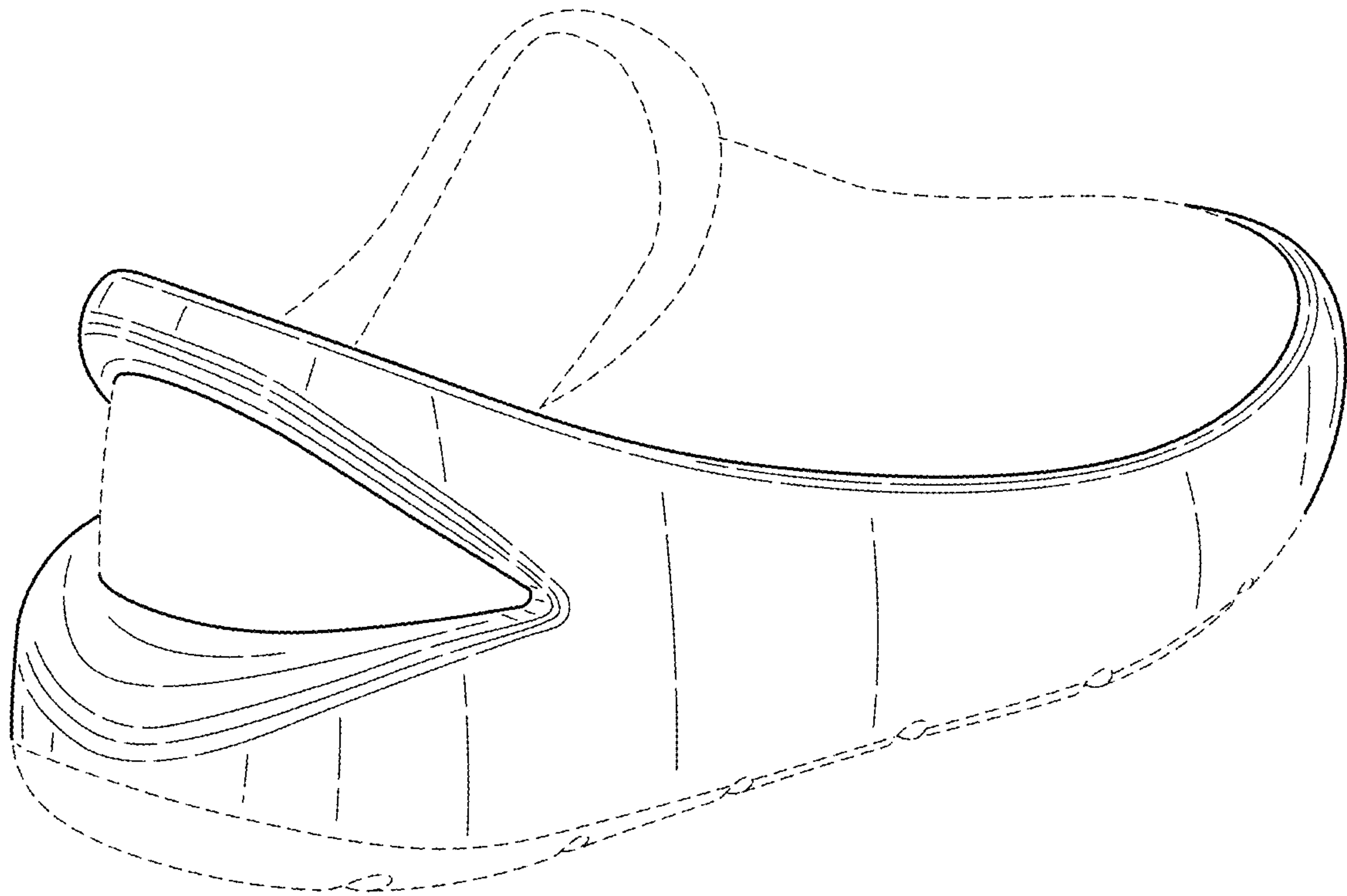

FIG. 1

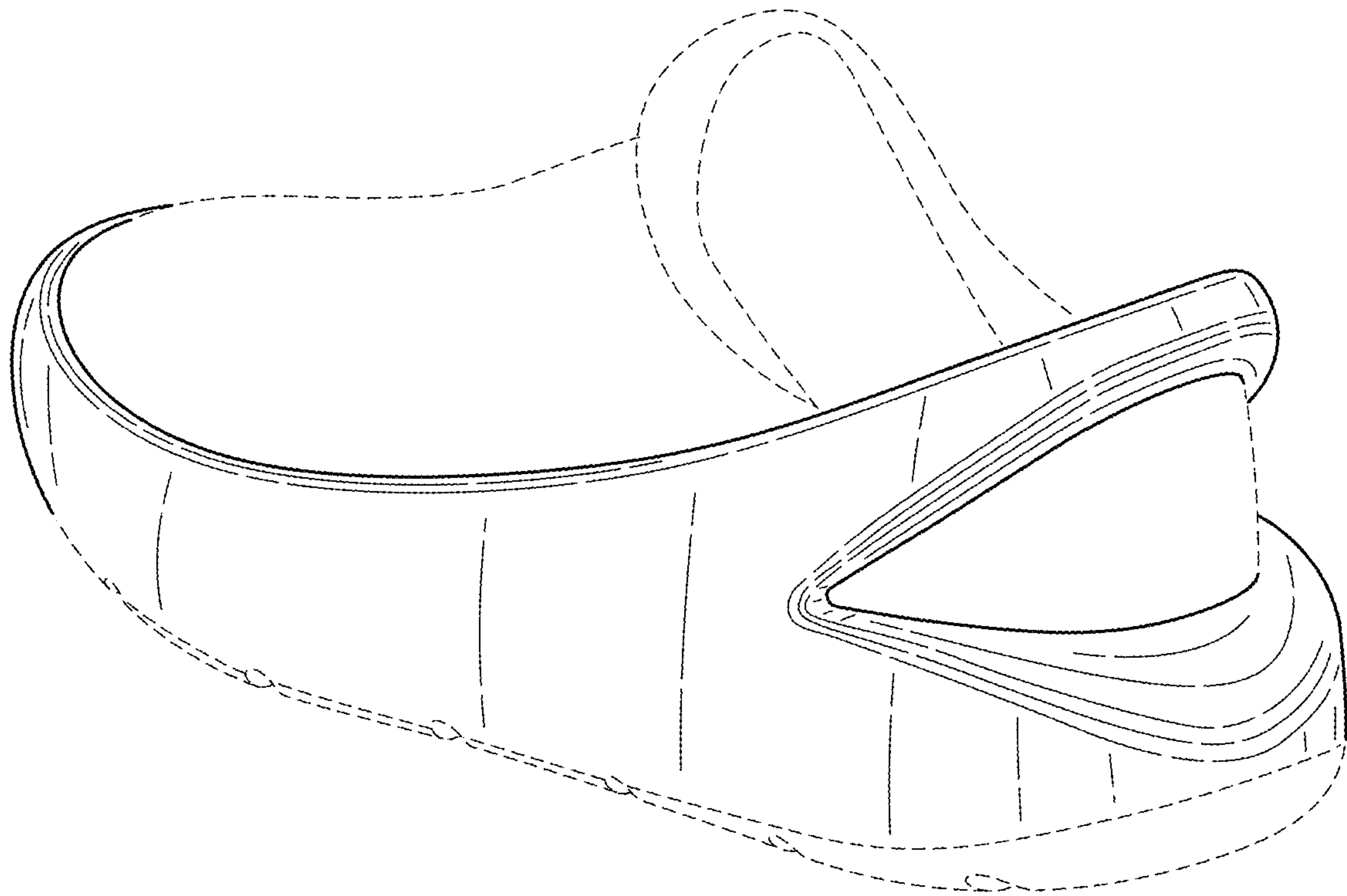

FIG.2

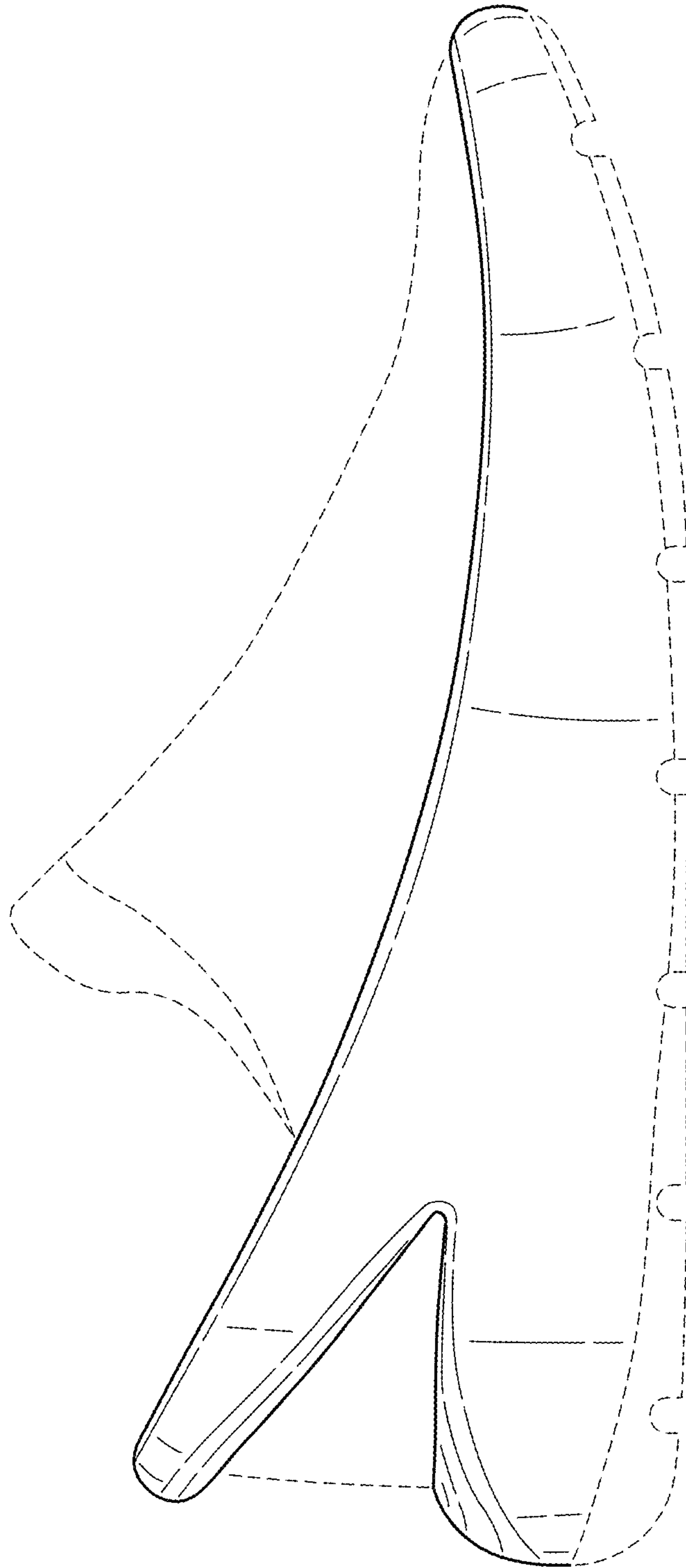

FIG.3

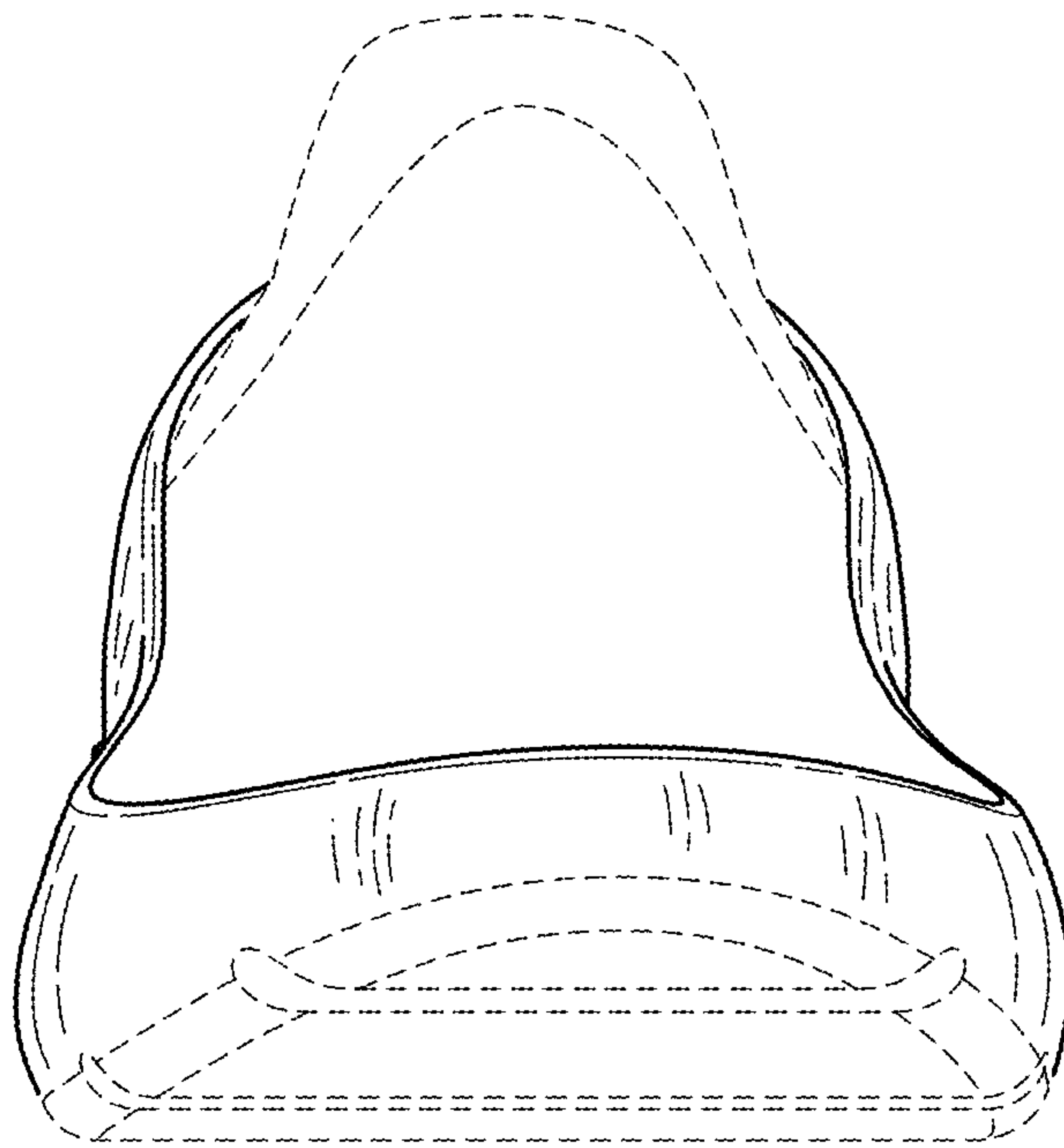

FIG.4

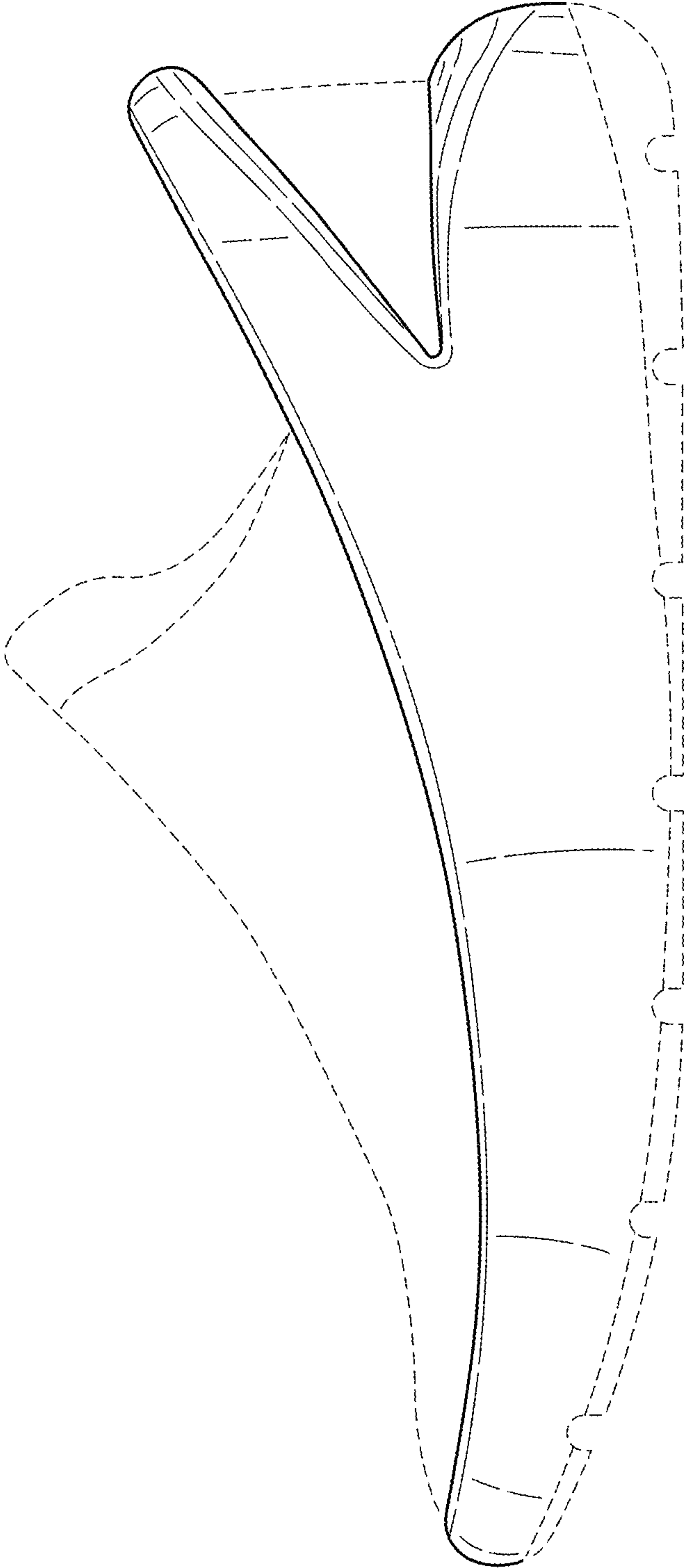

FIG.5

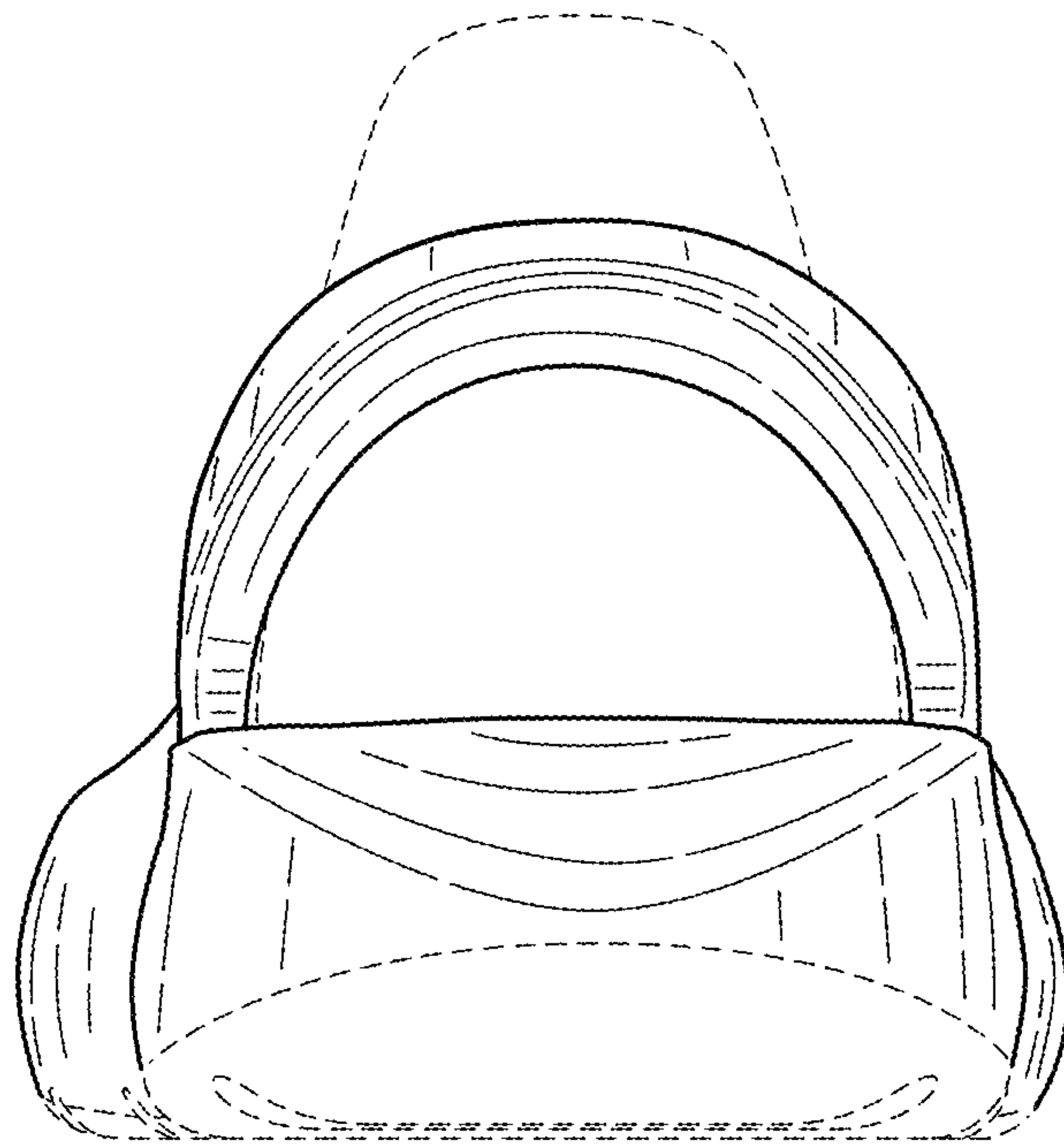

FIG. 6

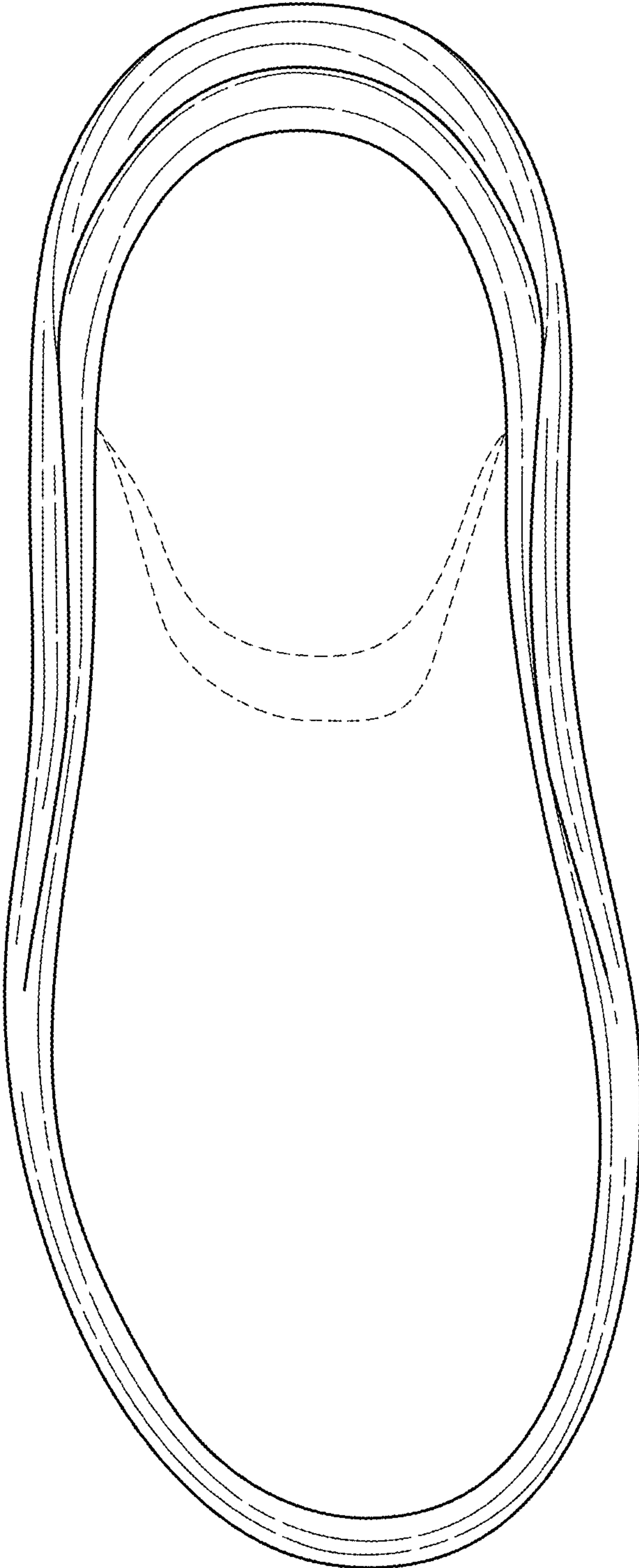

FIG.7