



US00D985863S

(12) **United States Design Patent** (10) **Patent No.:** **US D985,863 S**
Wen (45) **Date of Patent:** **** May 9, 2023**

(54) **BARK CONTROL**

(71) Applicant: **Shenzhen TIZE Technology Co., Ltd.**,
Guangdong (CN)

(72) Inventor: **Jian Wen**, Guangdong (CN)

(73) Assignee: **Shenzhen TIZE Technology Co., Ltd.**,
Guangdong (CN)

(**) Term: **15 Years**

(21) Appl. No.: **29/814,464**

(22) Filed: **Nov. 5, 2021**

(30) **Foreign Application Priority Data**

May 18, 2021 (CN) 202130295228.9

(51) **LOC (14) Cl.** **30-99**

(52) **U.S. Cl.**
USPC **D30/199; D10/104.1**

(58) **Field of Classification Search**
USPC D30/151-155, 144, 199, 160;
119/792-798, 850, 855-859, 863-865,
119/654, 905, 907, 815, 712, 802, 784,
119/769, 760, 776, 862, 908, 860,
119/719-721; 242/381.1-381.2, 385.4,
242/378.3, 376.1, 385.1, 916, 601, 570,
242/405, 404, 371, 223, 170, 388.1,
242/405.2, 377, 381.3, 381.6, 405.3,
242/388.6, 384.7, 382, 396.1, 404.1, 380;
362/108; 33/767, 769, 414; D12/400;
D3/229, 230, 207, 208, 215; 40/1.5, 455,
40/640, 303; 206/63.3, 459.5, 702, 408;
D6/515; D8/358, 360, 347, 360.1, 359,
D8/356, DIG. 1; D24/145, 167, 186, 146,
D24/169; D10/57, 72, 106.1, 104.1,
D10/104.2, 109.2, 70, 97, 98, 78, 65;
D20/28; 224/666, 678; 16/445; 283/74,
283/70; D11/232, 200, 216, 1, 2, 86, 87,
D11/201, 206-210, 212-215, 218;

24/163 K, 122.3, 323, 702, 600.4-600.7,
24/163 R, 169-171, 173, 177-179, 191,
24/194, 195, 197, 200, 303, 616, 635,
24/313, 615, 3, 6, 3 K, 599.2, 96, 221,
24/237, 311, 312, 314, 321, 338, 339,
24/309; 428/3, 4; 54/76, 1, 71; 63/29.1,
63/3; 191/12.2 R, 12.4; D13/154, 153,
D13/137.4, 155, 103, 168; D19/69, 67;
379/438; 446/26; 473/576; D22/140;
(Continued)

(56) **References Cited**

U.S. PATENT DOCUMENTS

D343,829 S * 2/1994 Okuda D18/50
D361,564 S * 8/1995 Inaba D14/426
(Continued)

Primary Examiner — Susan Moon Lee
(74) *Attorney, Agent, or Firm* — ScienBiziP, P.C.

(57) **CLAIM**

The ornamental design for a bark control, as shown and described.

DESCRIPTION

FIG. 1 is a front, left, and top perspective view of a bark control, showing my design.
FIG. 2 is a rear, right, and bottom perspective view thereof.
FIG. 3 is a front elevation view thereof.
FIG. 4 is a rear elevation view thereof.
FIG. 5 is a left side elevation view thereof.
FIG. 6 is a right side elevation view thereof.
FIG. 7 is a top plan view thereof; and,
FIG. 8 is a bottom plan view thereof.
The broken lines shown in the drawings are included for the purpose of illustrating portions of the bark control that form no part of the claimed design.

1 Claim, 8 Drawing Sheets

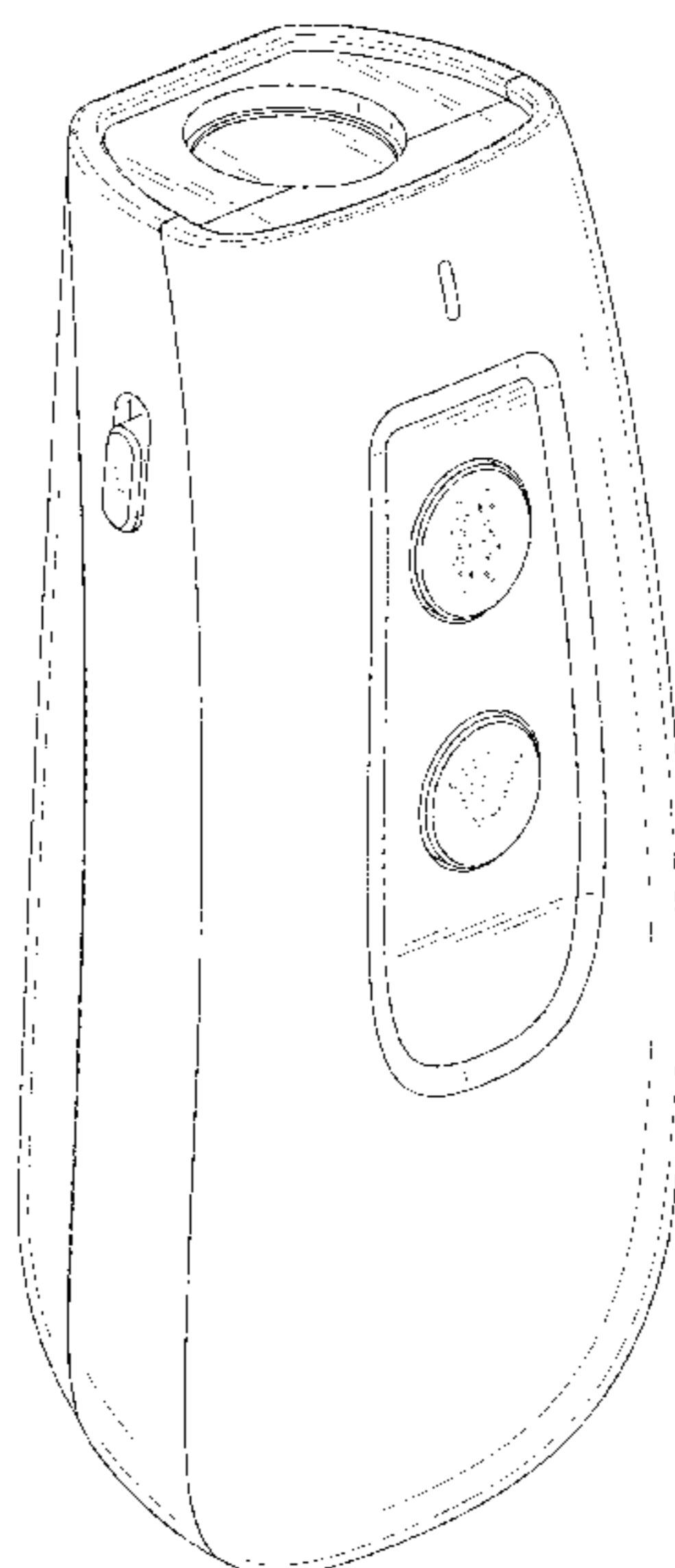

(58) **Field of Classification Search**

USPC 174/135; 439/504, 13, 501; D34/33;
 188/83, 82.1, 65.1; 254/134.3 FT;
 D29/124; D2/627, 624, 633, 625;
 132/145, 146, 148; 2/314; 59/79.1;
 340/573.3, 573.1, 573, 573.4,
 340/539.13-539.19; 343/895;
 278/8 AES; 231/7; 361/232; D14/344,
 D14/341, 137, 155, 496, 203.5, 203.3,
 D14/144, 218, 188, 216, 192;
 342/357.51, 357.57, 357.52, 357.55;
 455/100, 352, 456.1, 550.1; 315/291
 CPC A01K 15/021; A01K 15/02; A01K 15/022;
 A01K 15/023; A01K 15/029; A01K
 15/04; A01K 15/00; A01K 15/006; A01K
 12/022; A01K 27/009; A01K 27/00;
 A01K 27/001; A01K 27/006-008; A01K
 29/005; A01K 29/00; A61B 5/0002-0028;
 A61B 5/681; A61B 5/6822; A61B
 5/6824; A61B 5/6829; G01S 5/0294

See application file for complete search history.

(56) **References Cited**

U.S. PATENT DOCUMENTS

D375,748 S * 11/1996 Hartman D14/218
 D380,473 S * 7/1997 Otani D14/218
 D391,229 S * 2/1998 Thomas D13/168
 D391,230 S * 2/1998 Thomas D13/168
 D404,717 S * 1/1999 Duchon D13/168
 D415,735 S * 10/1999 Zuege D13/168
 D420,006 S * 2/2000 Tonino D14/218
 6,052,097 A * 4/2000 Duncan H01Q 1/273
 343/788
 D449,995 S * 11/2001 Christianson D10/2
 D462,069 S * 8/2002 Gatto D14/218
 D482,630 S * 11/2003 So D30/199
 D502,929 S * 3/2005 Copeland D13/168
 D509,817 S * 9/2005 Gong D14/155
 D511,750 S * 11/2005 Badarello D13/168
 D563,907 S * 3/2008 Badarello D13/168
 D566,712 S * 4/2008 Ah D14/426
 D612,853 S * 3/2010 Waterman D14/427
 7,837,112 B2 * 11/2010 An G06K 7/10891
 235/462.43
 D630,388 S * 1/2011 Lai D30/199
 D661,209 S * 6/2012 Janky D10/78
 D664,457 S * 7/2012 Buchanan D10/78
 D692,431 S * 10/2013 Arceta D14/427
 D708,796 S * 7/2014 Sproviero D10/104.1
 D722,584 S * 2/2015 Chen D14/155
 D725,098 S * 3/2015 Neumann D10/78

D726,681 S * 4/2015 Liu D14/155
 D740,144 S * 10/2015 Lamer D10/78
 D760,668 S * 7/2016 Mishan D13/168
 D767,511 S * 9/2016 Gong D13/168
 D770,455 S * 11/2016 Lee D14/433
 D771,244 S * 11/2016 Takemoto D24/113
 D782,985 S * 4/2017 Mishan D13/168
 D790,546 S * 6/2017 Zhou D14/426
 D794,945 S * 8/2017 Chung D3/205
 D796,454 S * 9/2017 Zheng D13/168
 D805,482 S * 12/2017 McRoberts D13/168
 D821,334 S * 6/2018 McRoberts D13/168
 D824,863 S * 8/2018 McRoberts D13/168
 D829,212 S * 9/2018 Bidwell D14/426
 D849,698 S * 5/2019 Chen D13/168
 D857,017 S * 8/2019 Cheng D14/218
 D870,057 S * 12/2019 Gassner D13/168
 D873,222 S * 1/2020 Altonen D13/168
 D877,090 S * 3/2020 Lu D13/168
 D879,054 S * 3/2020 Shen D13/168
 D888,052 S * 6/2020 Manoharan D14/357
 D889,758 S * 7/2020 Van Curen D10/104.1
 D896,339 S * 9/2020 Zhuo D22/120
 D897,614 S * 9/2020 Tang D30/199
 D907,603 S * 1/2021 Cheng D14/218
 D907,634 S * 1/2021 Bidwell D14/453
 D917,115 S * 4/2021 Tang D10/104.1
 D925,691 S * 7/2021 Jia D22/120
 D936,916 S * 11/2021 Li D10/104.1
 D944,471 S * 2/2022 Li D10/104.1
 D946,218 S * 3/2022 Xiao D10/104.1
 D948,815 S * 4/2022 Jin D10/104.1
 D949,493 S * 4/2022 Luo D10/104.1
 D951,565 S * 5/2022 Li D10/104.1
 D952,967 S * 5/2022 Li D10/104.1
 D959,313 S * 8/2022 Cran D10/119.3
 D963,968 S * 9/2022 Jia D10/104.1
 D973,983 S * 12/2022 Yang D30/199
 D975,385 S * 1/2023 Wang D10/104.1
 D975,942 S * 1/2023 Tan D30/199
 2003/0141370 A1 * 7/2003 Hamilton G06F 16/434
 707/E17.113
 2004/0149829 A1 * 8/2004 Boucher G06K 7/10861
 235/462.43
 2005/0194446 A1 * 9/2005 Wiklof G06K 7/0004
 235/462.46
 2007/0210785 A1 * 9/2007 Sanoner G01R 29/085
 324/67
 2008/0042657 A1 * 2/2008 Radle G01R 31/69
 324/67
 2009/0276115 A1 * 11/2009 Chen G07C 5/0808
 701/29.6
 2011/0214619 A1 * 9/2011 Risch A01M 31/004
 362/184
 2020/0015456 A1 * 1/2020 Van Curen A01K 15/022

* cited by examiner

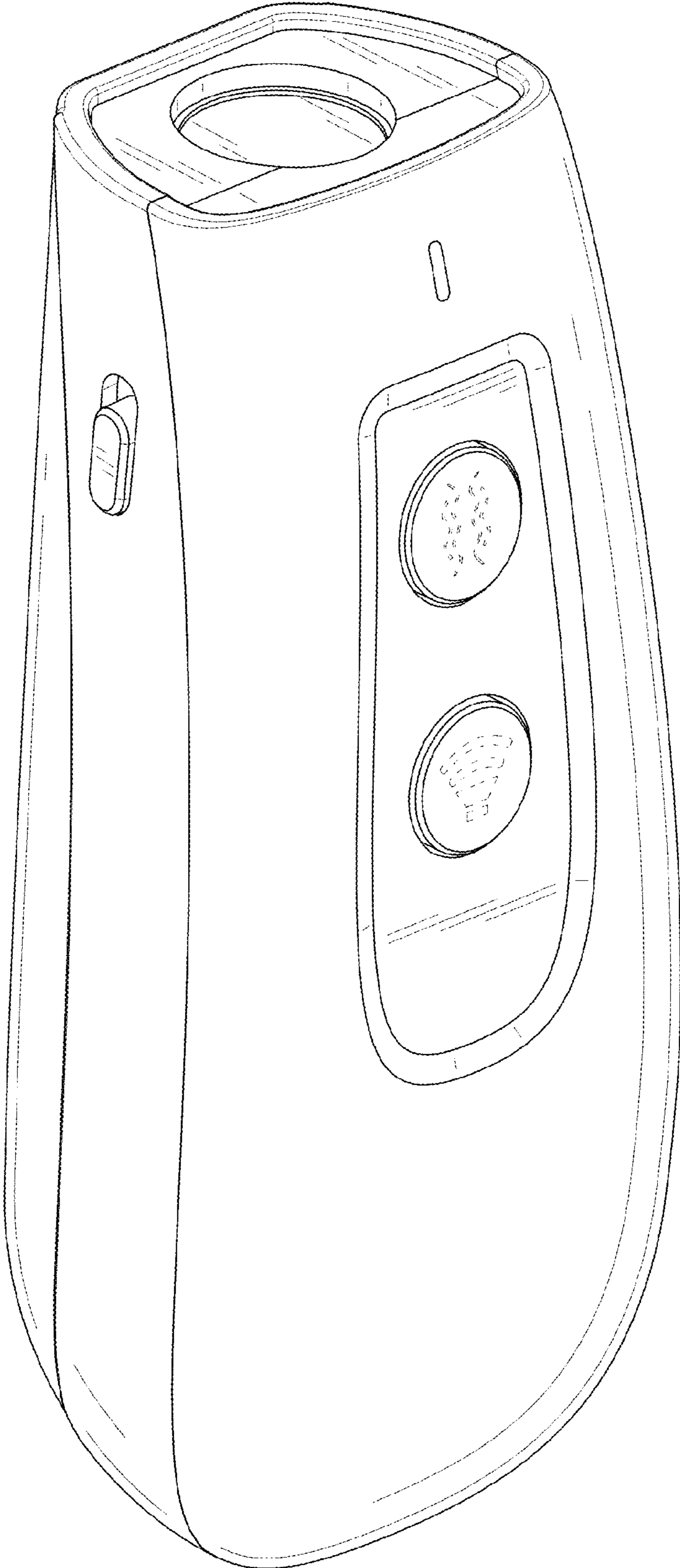

FIG. 1

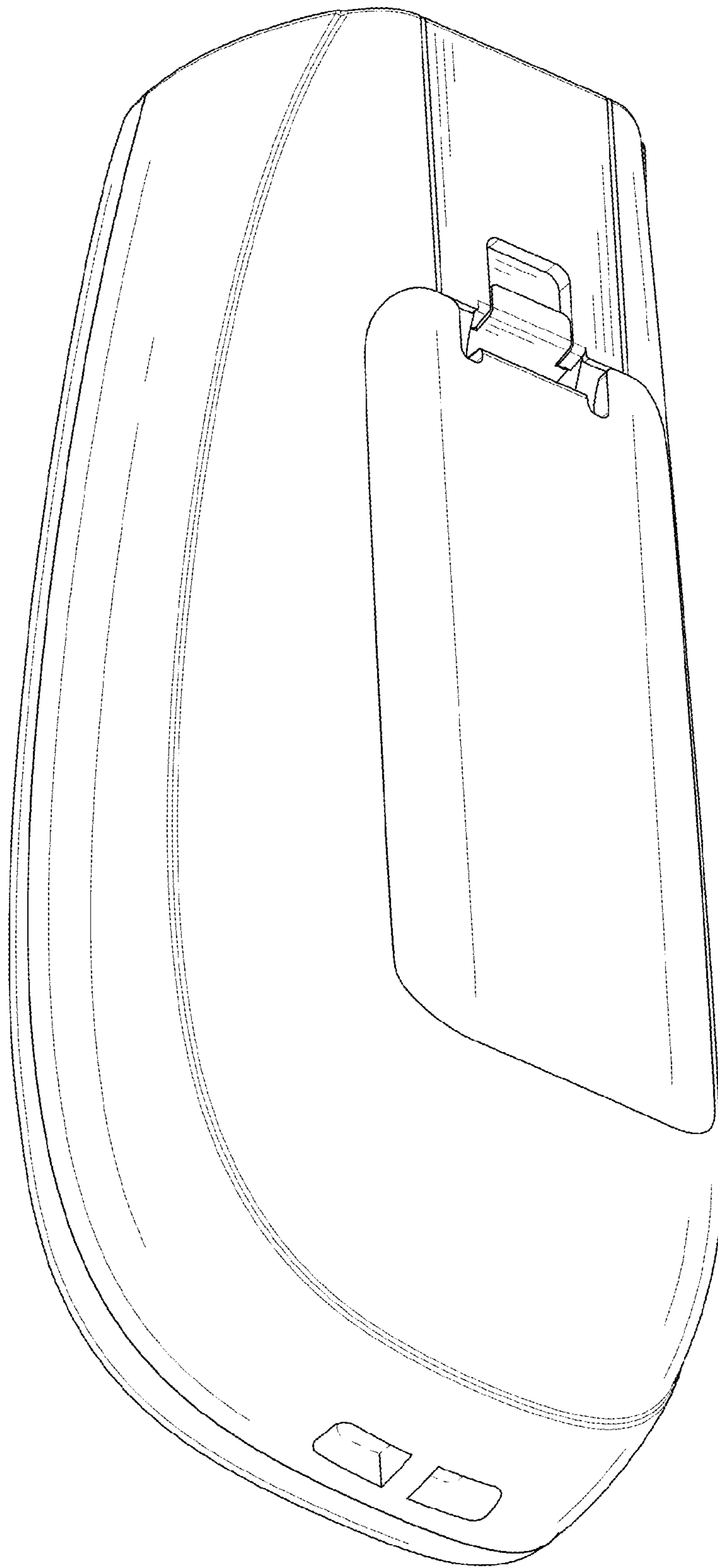

FIG. 2

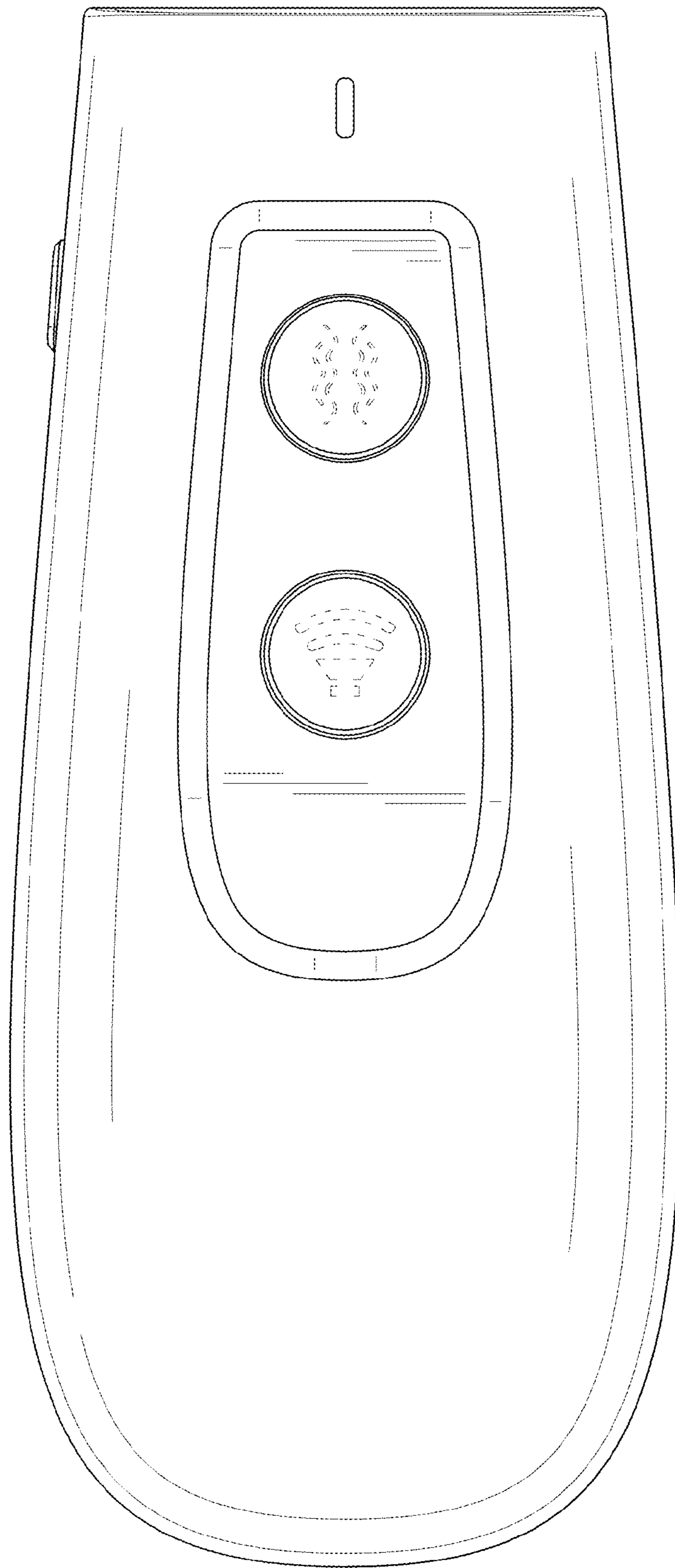

FIG. 3

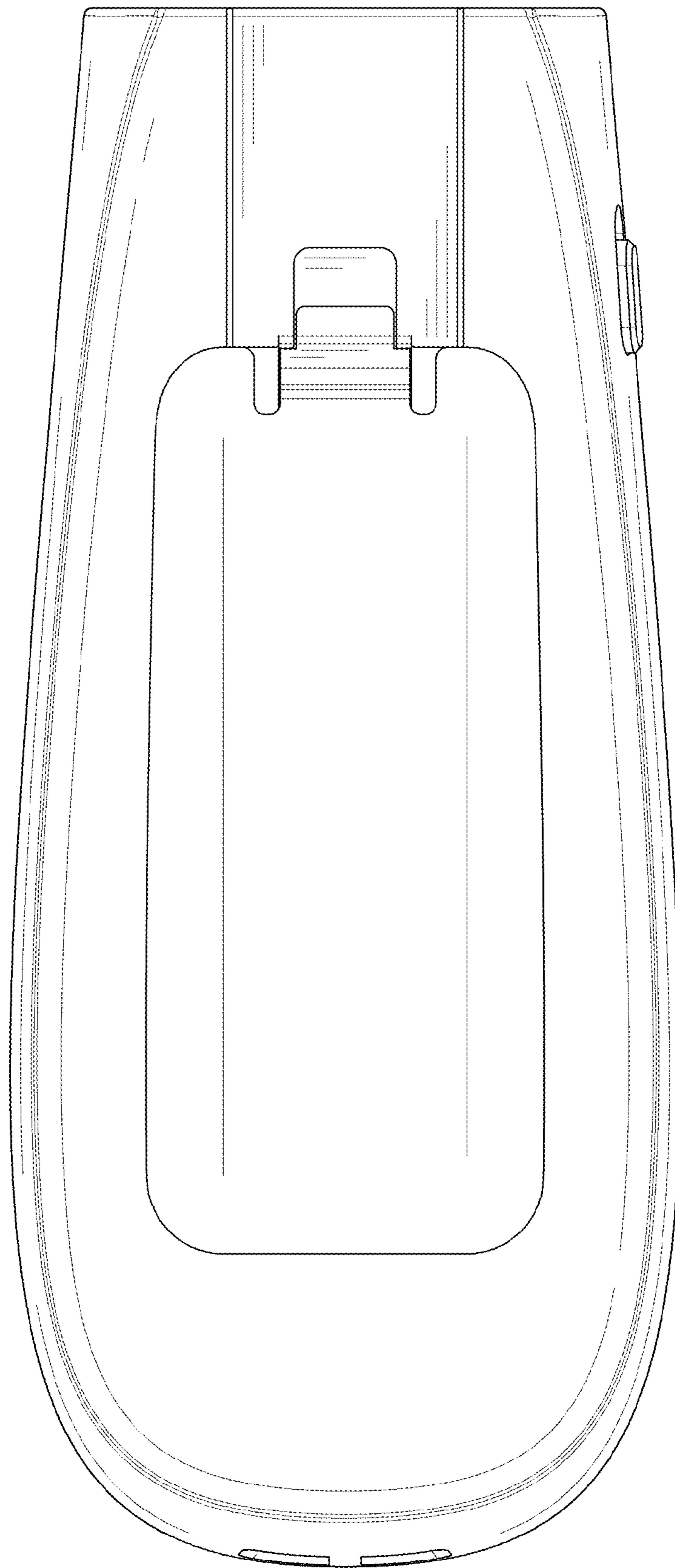

FIG. 4

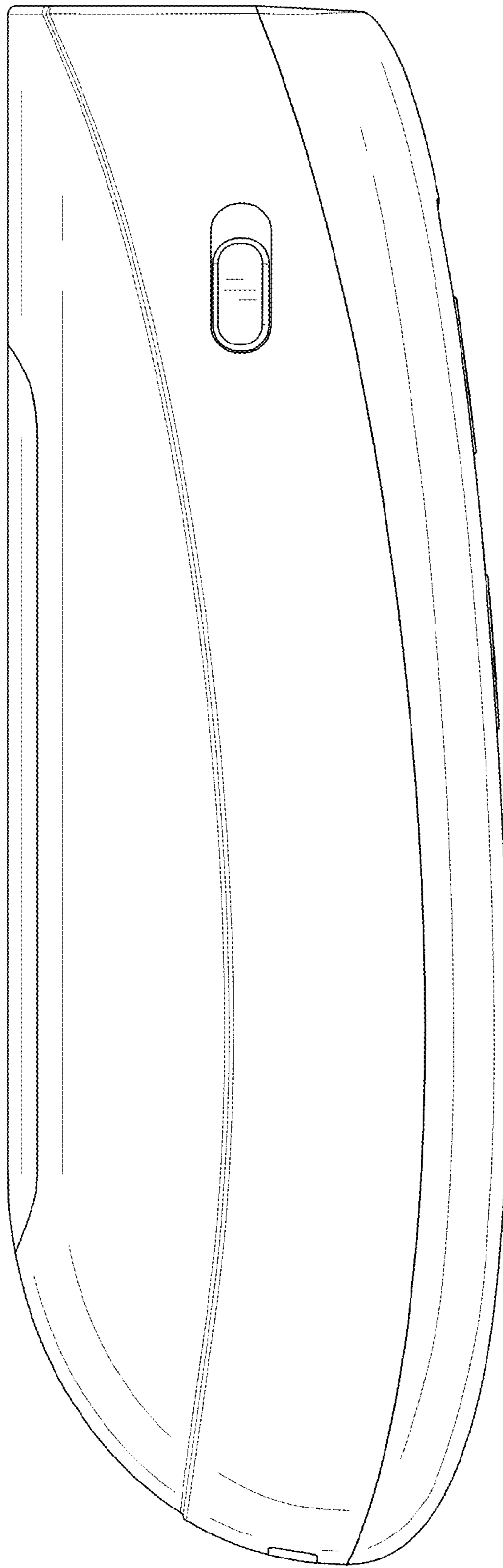

FIG. 5

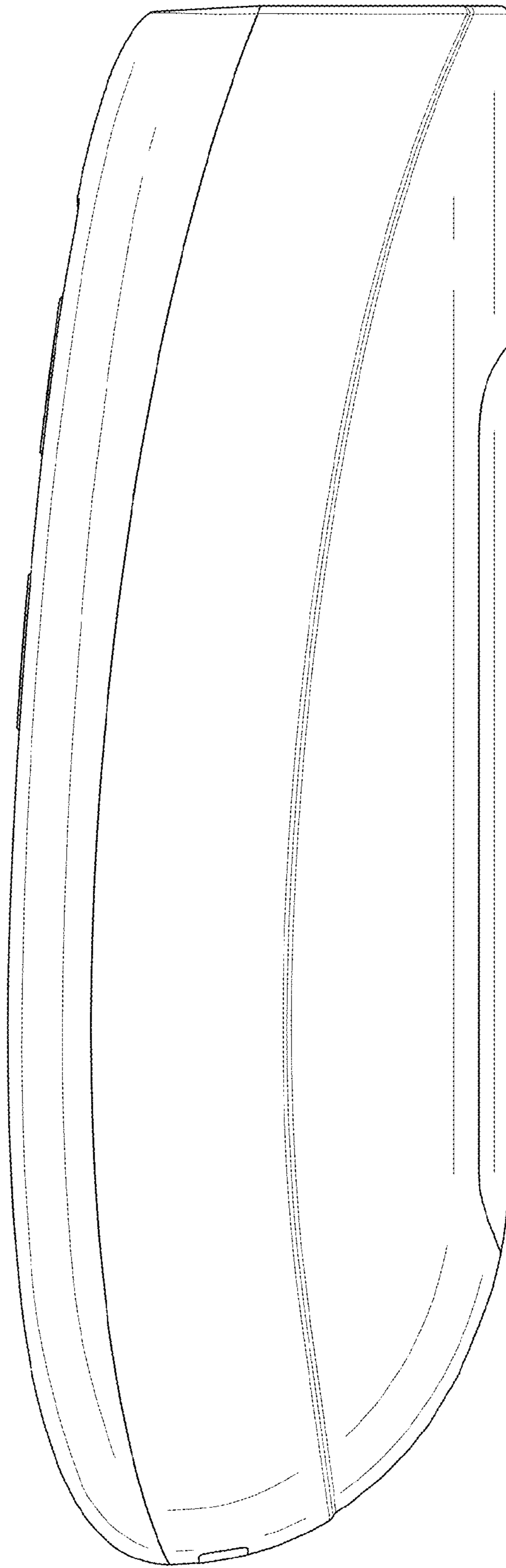

FIG. 6

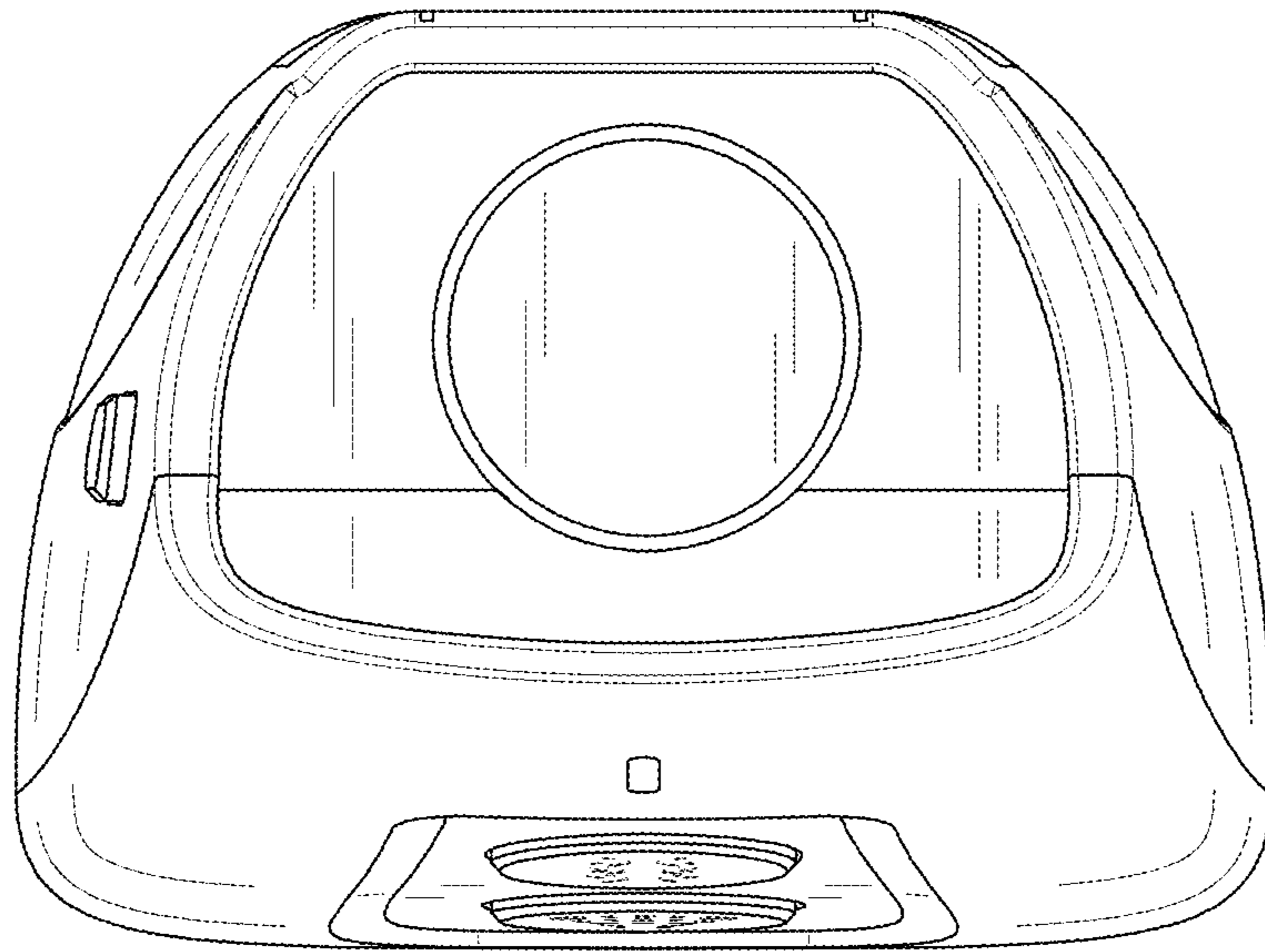

FIG. 7

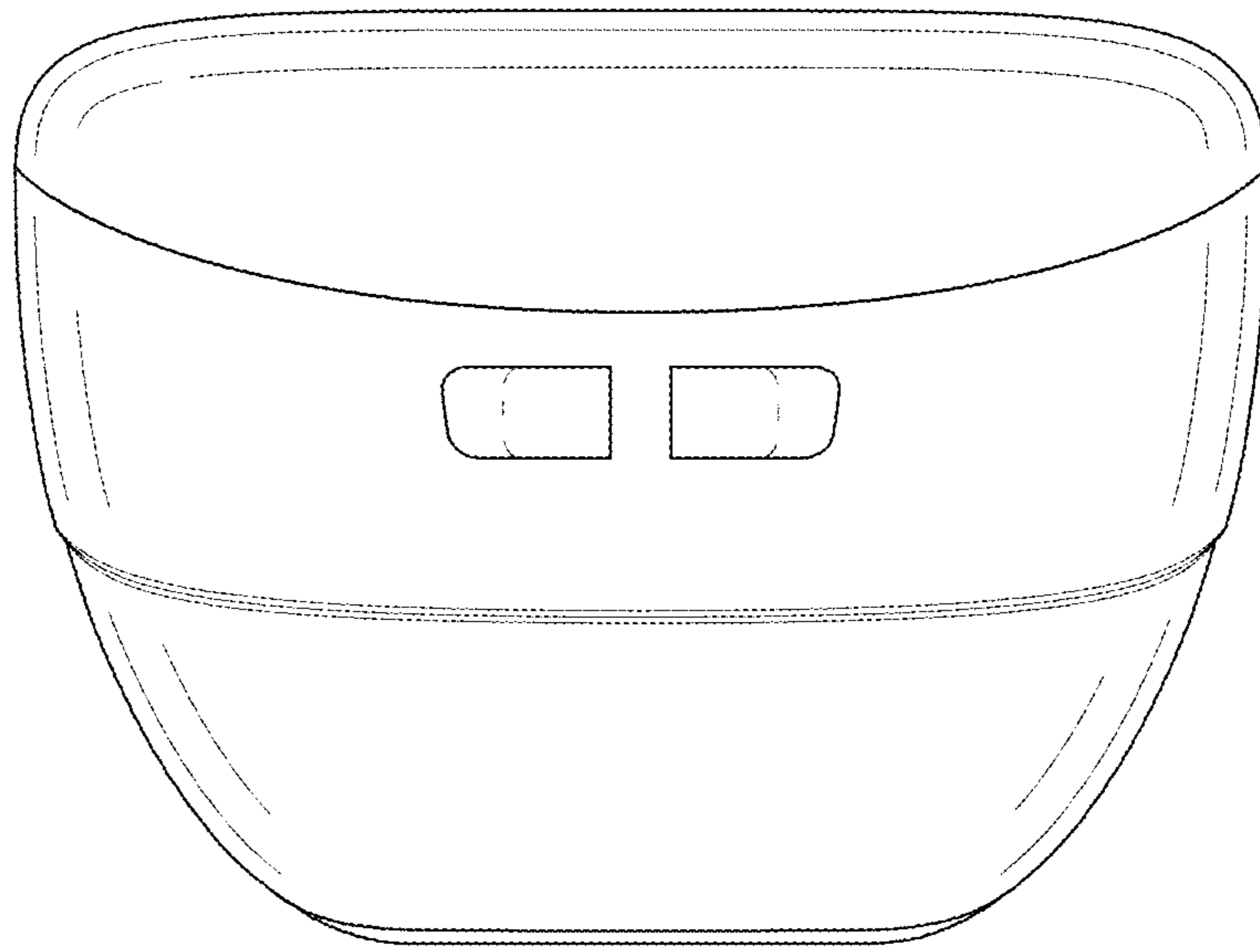

FIG. 8