



US00D985819S

(12) **United States Design Patent**
Jiang

(10) **Patent No.:** **US D985,819 S**

(45) **Date of Patent:** **** May 9, 2023**

(54) **BOOK LIGHT**

(71) Applicant: **Hong Jiang**, Guangdong (CN)

(72) Inventor: **Hong Jiang**, Guangdong (CN)

(**) Term: **15 Years**

(21) Appl. No.: **29/869,787**

(22) Filed: **Jan. 9, 2023**

(51) **LOC (14) Cl.** **26-05**

(52) **U.S. Cl.**
USPC **D26/60; D26/62**

(58) **Field of Classification Search**
USPC D26/24, 37-52, 60-66, 104-110, 113
CPC F21W 2131/3005; F21W 2131/30; F21V
21/0885; F21V 21/08; F21V 21/32; F21V
21/145; F21V 23/0414; F21S 4/22; F21Y
2115/10
See application file for complete search history.

(56) **References Cited**

U.S. PATENT DOCUMENTS

D367,541 S *	2/1996	Kuo	D26/62
D428,177 S *	7/2000	Chan	D26/60
D498,322 S *	11/2004	Schnell	D26/62
D590,533 S *	4/2009	Li	D26/62
D824,580 S *	7/2018	Hu	D26/107
D825,823 S *	8/2018	Ren	D26/107
D838,887 S	1/2019	Su	
D838,888 S *	1/2019	Shengbiao	D26/60
D861,944 S *	10/2019	Wu	D26/60
D870,942 S *	12/2019	Yang	D26/60

D890,399 S *	7/2020	Su	D26/60
D899,654 S *	10/2020	Zhou	D26/60
D901,739 S *	11/2020	Wu	D26/60

FOREIGN PATENT DOCUMENTS

GB 6254070 * 1/2023

* cited by examiner

Primary Examiner — Mark A Goodwin
Assistant Examiner — William B Melliar

(57) **CLAIM**

The ornamental design for a book light, as shown and described.

DESCRIPTION

FIG. 1 is a front and top perspective view of a book light, showing my new design;
FIG. 2 is a rear and bottom perspective view thereof;
FIG. 3 is a front elevation view thereof;
FIG. 4 is a rear elevation view thereof;
FIG. 5 is a left side elevation view thereof;
FIG. 6 is a right side elevation view thereof;
FIG. 7 is a top plan view thereof;
FIG. 8 is a bottom plan view thereof; and,
FIG. 9 is an enlarged perspective view of detail "9" identified in FIG. 2.
The dashed lines in the figures illustrate portions of the book light that form no part of the claimed design. The dash dot dash lines in FIGS. 2 and 9 are for the purpose of illustrating the enlarged view indicators and form no part of the claimed design.

1 Claim, 9 Drawing Sheets

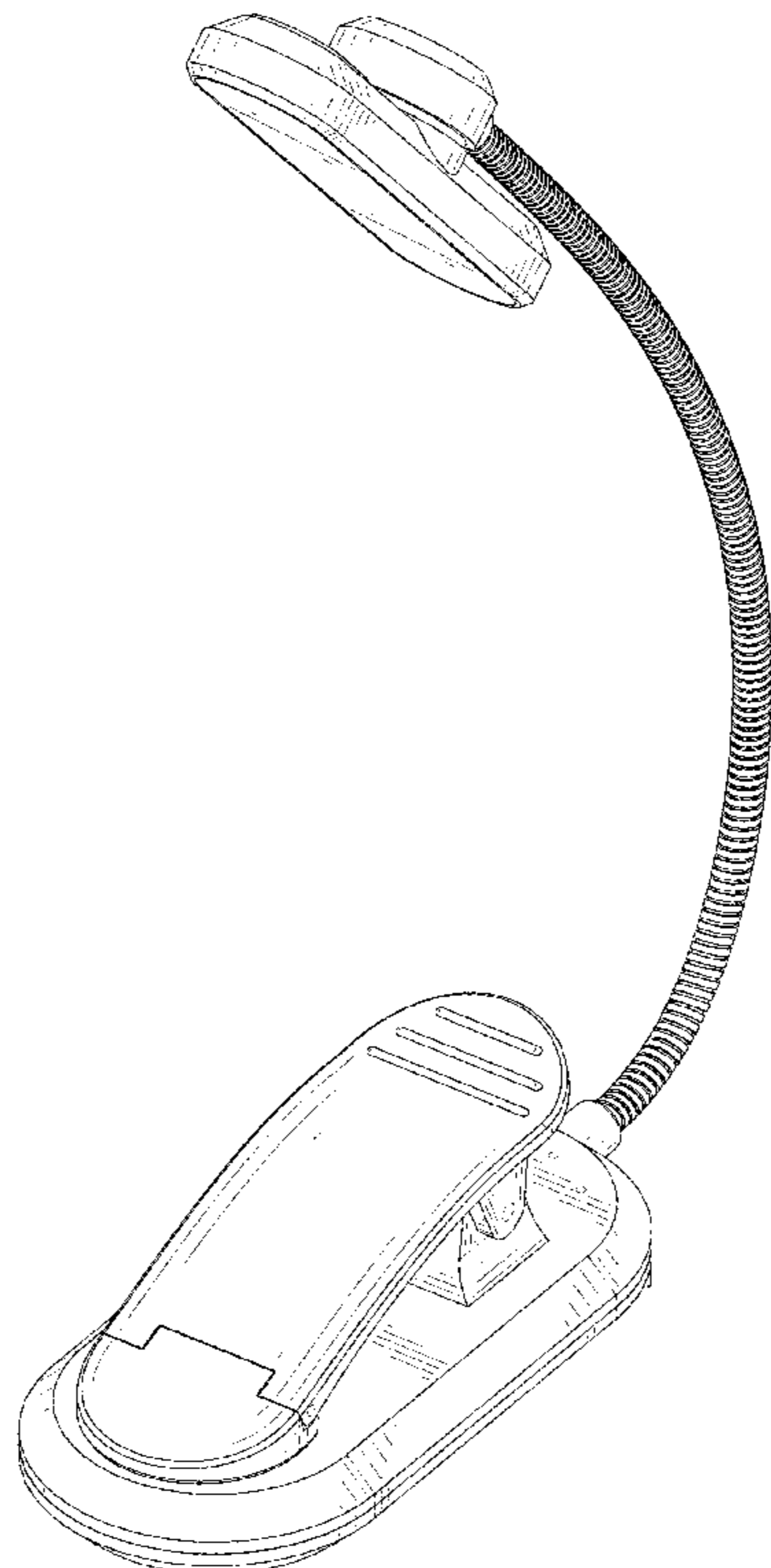

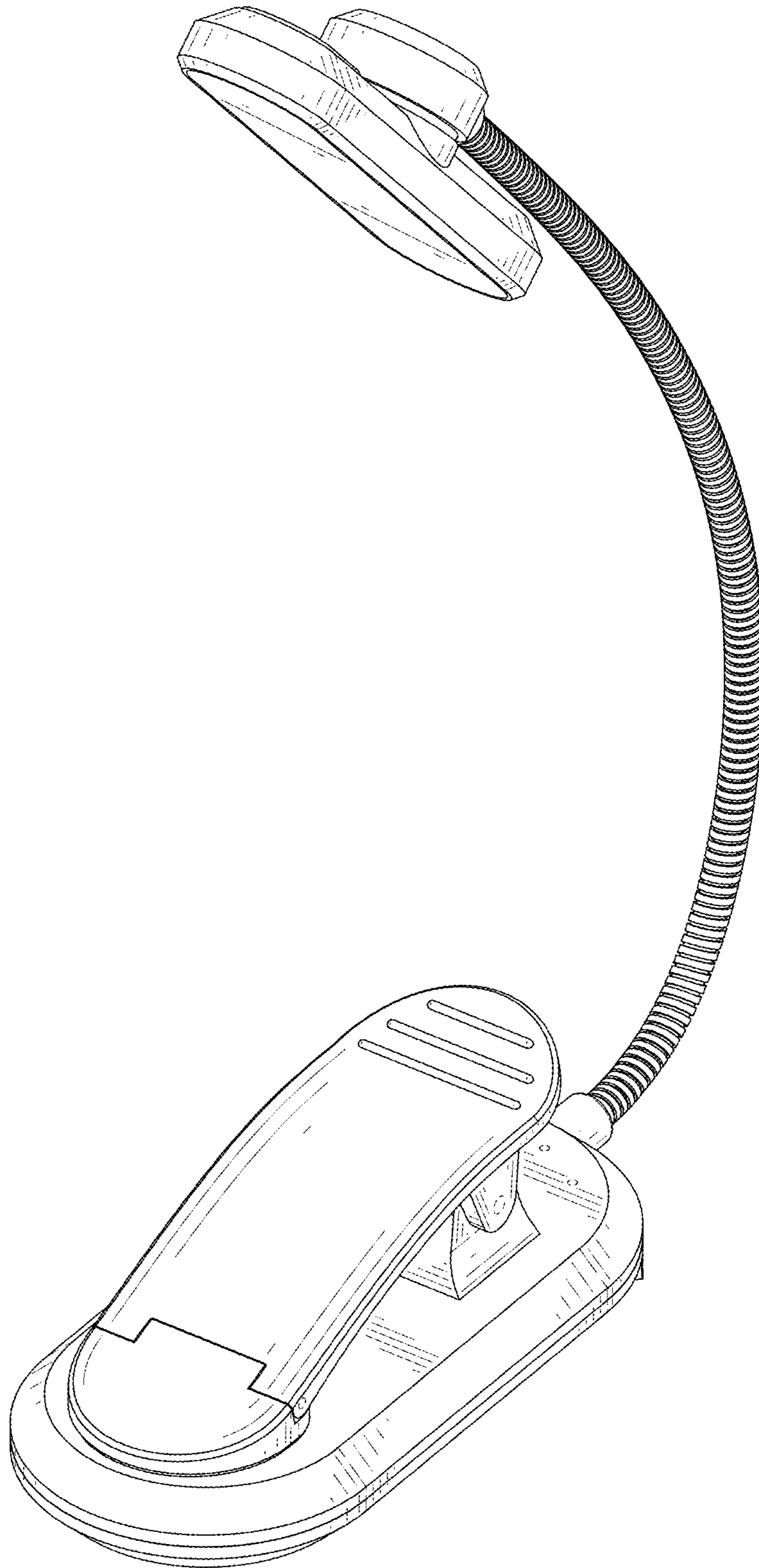

FIG. 1

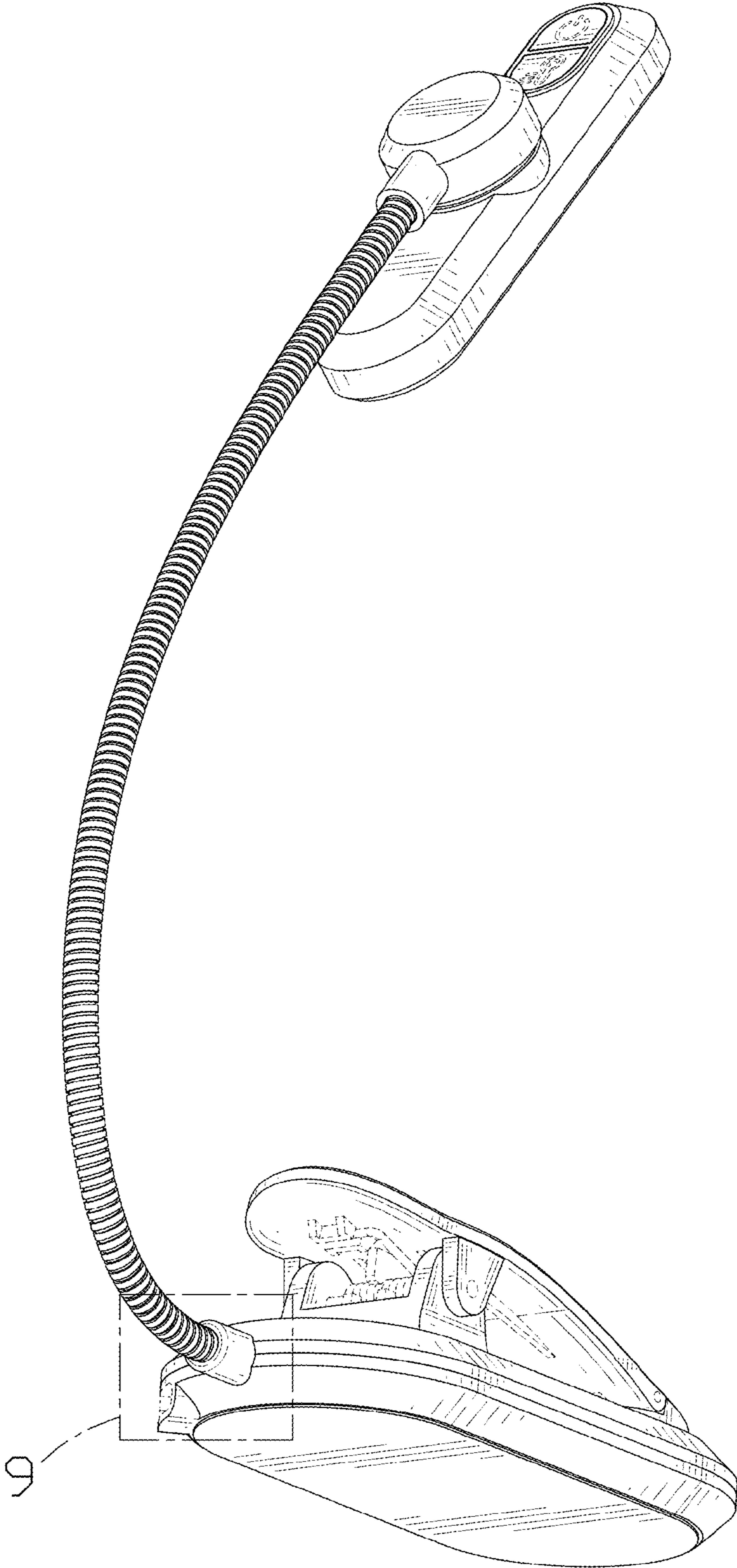

FIG. 2

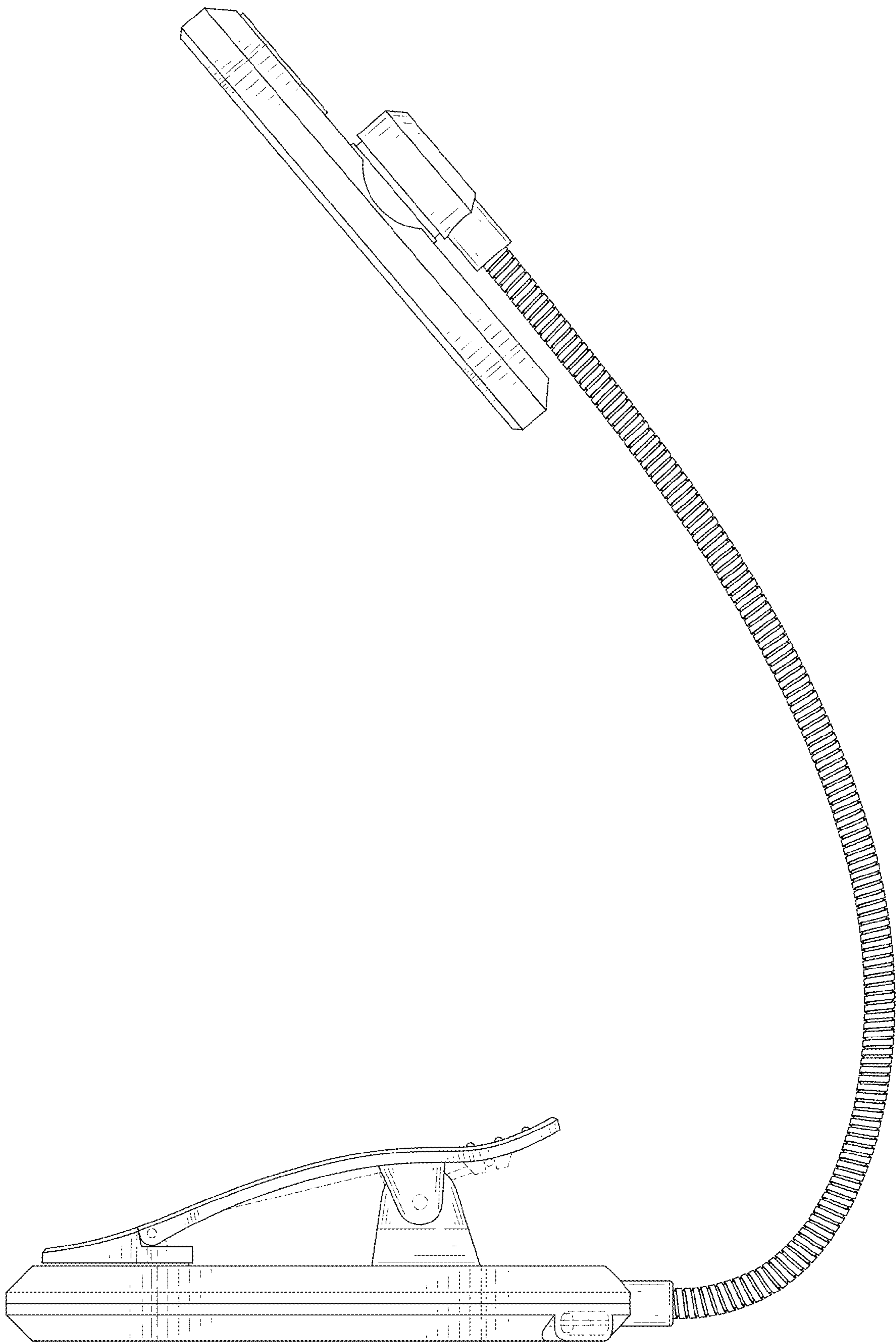

FIG. 3

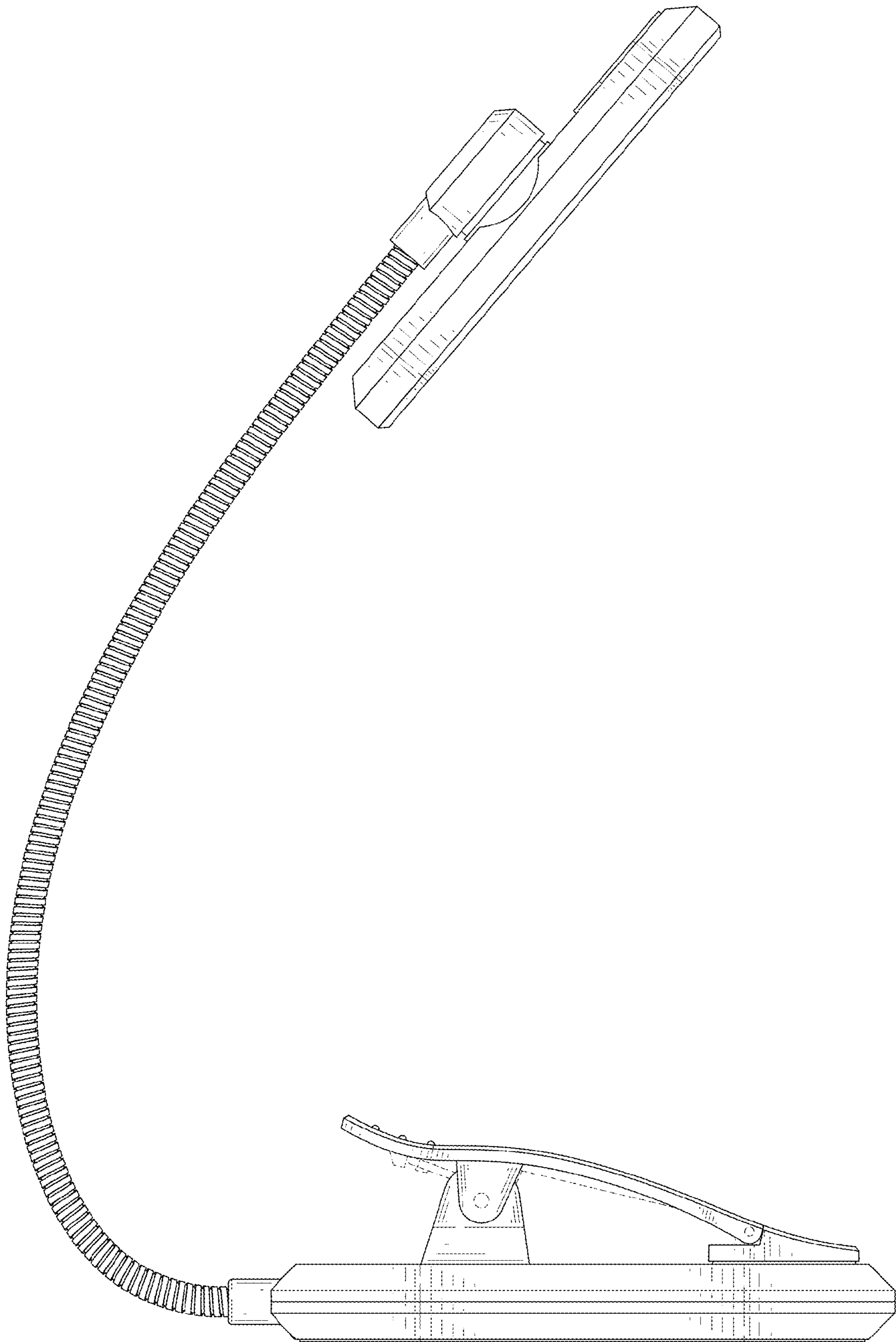

FIG. 4

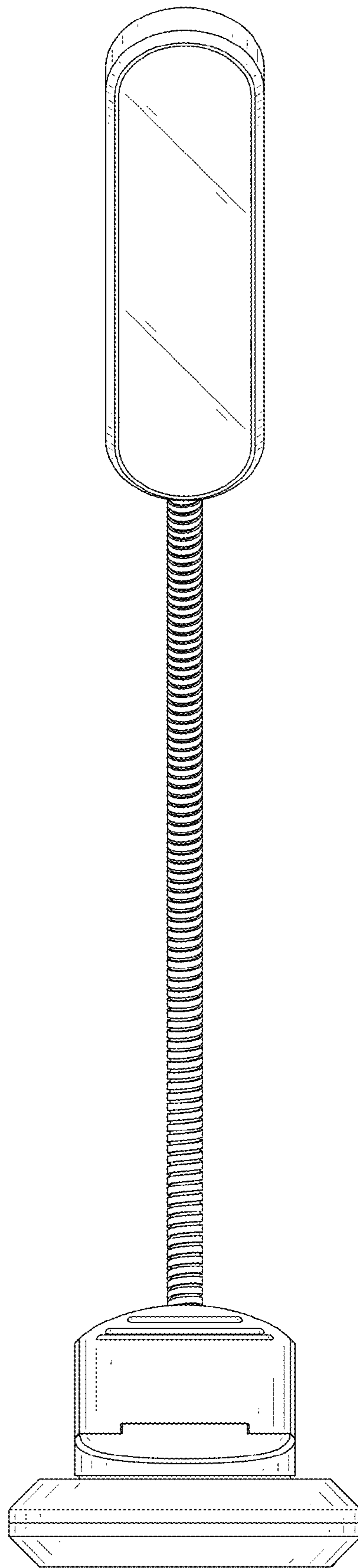

FIG. 5

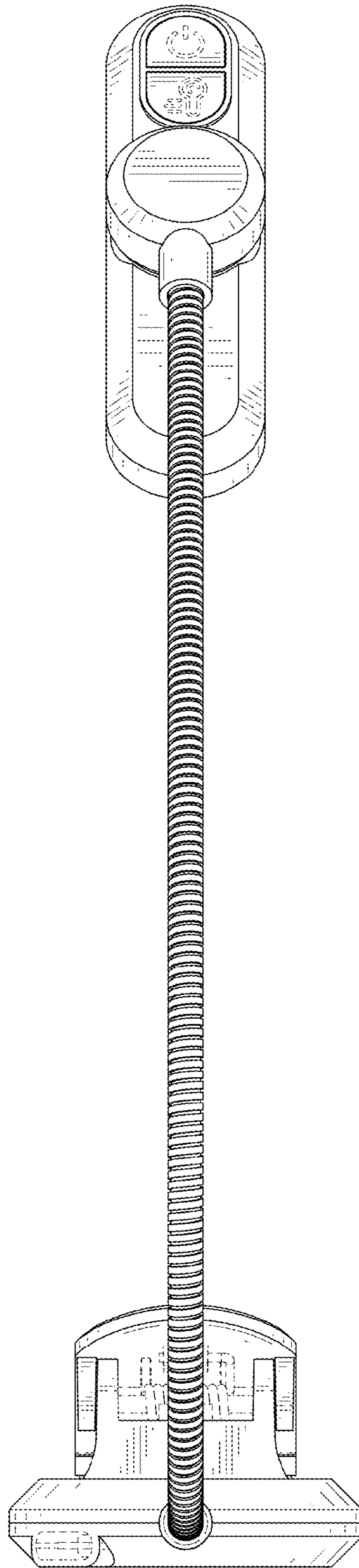

FIG. 6

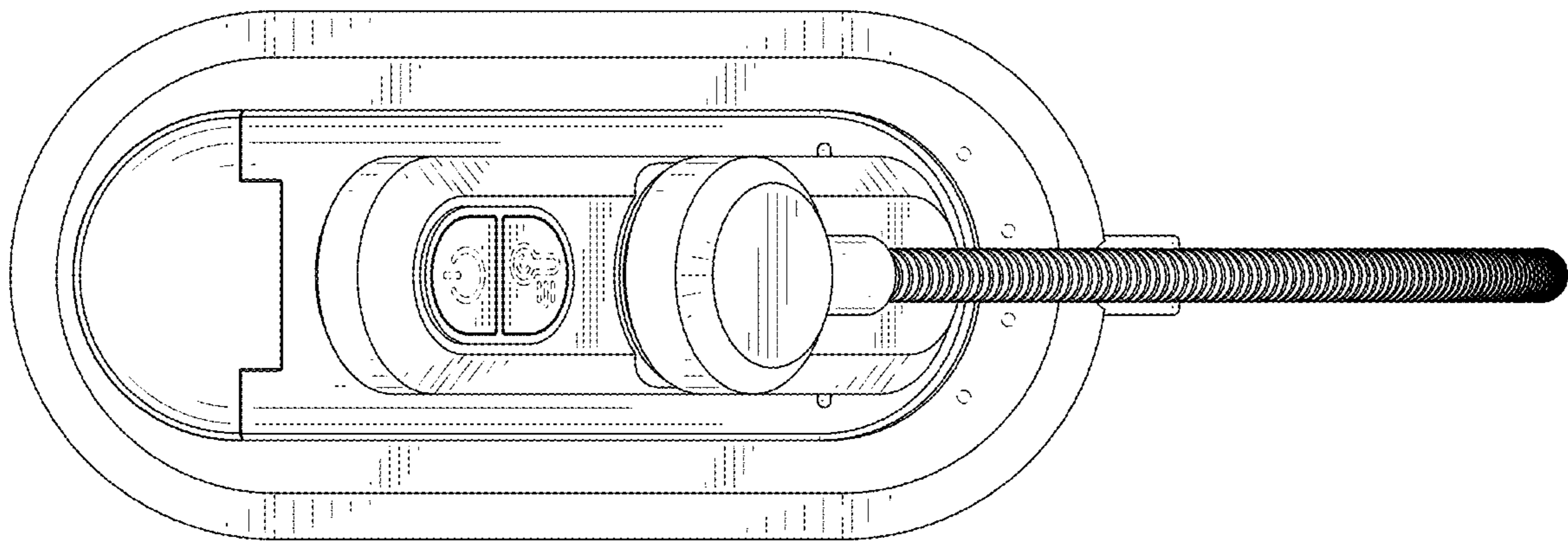

FIG. 7

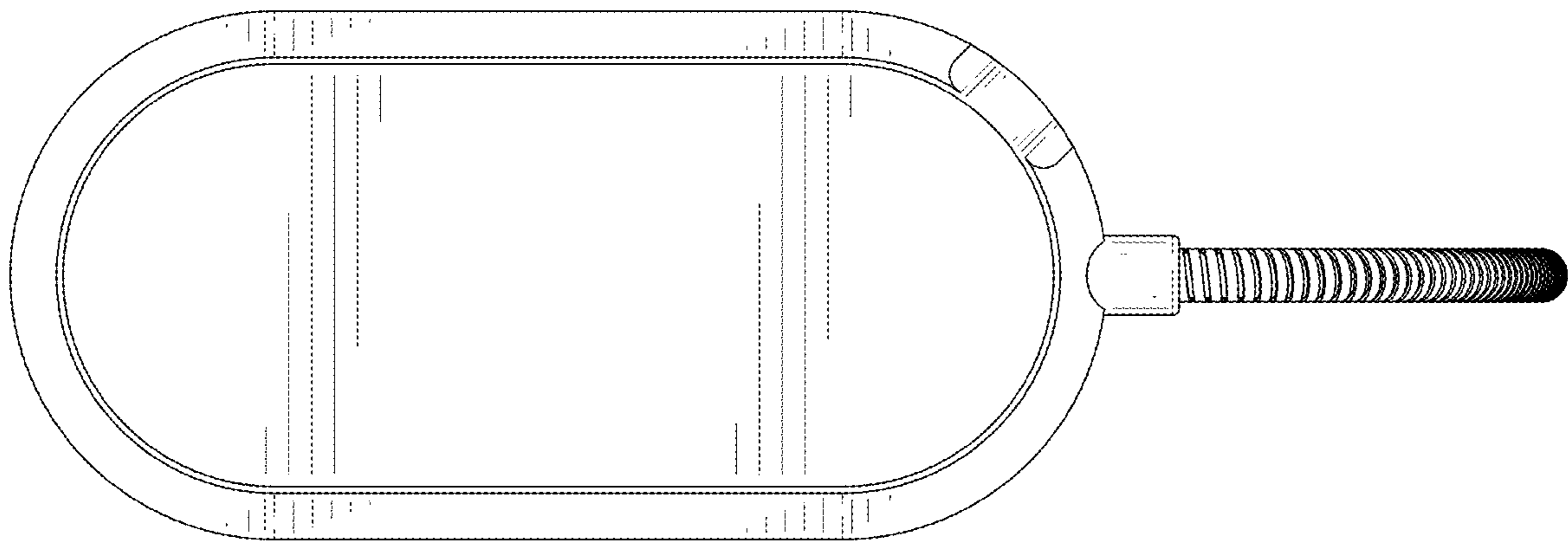

FIG. 8

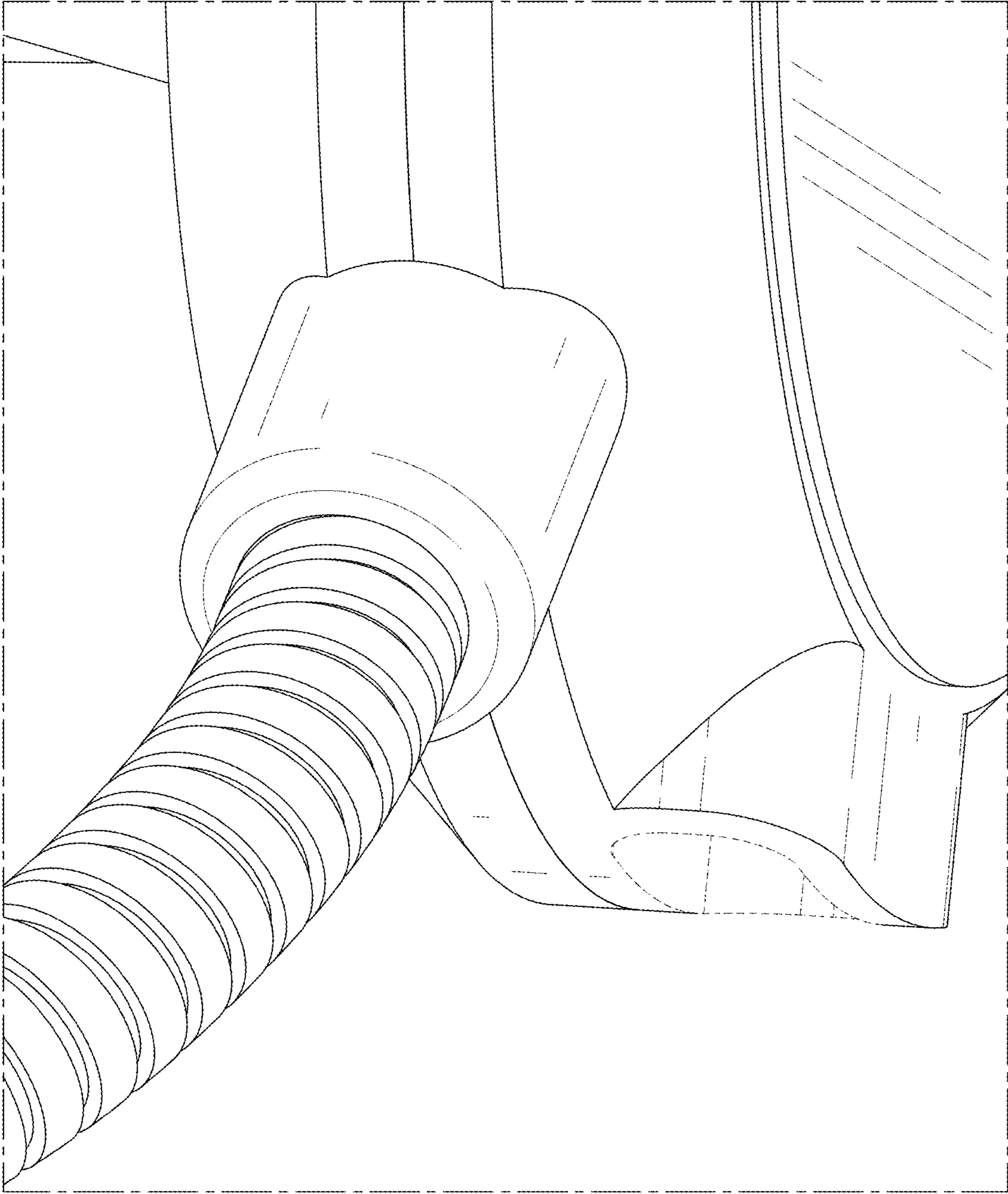

FIG. 9