



US00D985571S

(12) **United States Design Patent**  
**You et al.**

(10) **Patent No.:** **US D985,571 S**  
(45) **Date of Patent:** **\*\* May 9, 2023**

(54) **DISPLAY STAND**

(71) Applicant: **NINGBO TUOTUO RIVER DESIGN COMPANY, Zhejiang (CN)**

(72) Inventors: **Xiaodong You, Ningbo (CN); Hongjun Wang, Ningbo (CN)**

(73) Assignee: **NINGBO TUOTUO RIVER DESIGN COMPANY, Ningbo (CN)**

(\*\*) Term: **15 Years**

(21) Appl. No.: **29/788,362**

(22) Filed: **May 10, 2021**

(51) **LOC (14) Cl.** ..... **14-02**

(52) **U.S. Cl.**  
USPC ..... **D14/253; D14/447**

(58) **Field of Classification Search**  
USPC ... D14/209.1, 217, 224, 229, 253, 434, 447,  
D14/451, 452, 453; D13/108; D19/75;  
D6/682; D8/380  
CPC .. F16M 13/00; A47B 2023/049; A47B 23/04;  
A47B 2220/0091  
See application file for complete search history.

(56) **References Cited**

**U.S. PATENT DOCUMENTS**

D423,821 S *	5/2000	Crump	.....	D6/681.2
D671,110 S *	11/2012	Choi	.....	D14/253
D724,072 S *	3/2015	Jiang	.....	D14/447
D865,747 S *	11/2019	Sage	.....	D14/447
D884,711 S *	5/2020	Zhang	.....	D14/447
D915,359 S *	4/2021	Zhang	.....	D14/224
D920,981 S *	6/2021	Zhang	.....	D14/434
D931,848 S *	9/2021	Liu	.....	D14/253

D934,234 S *	10/2021	Deng	.....	D14/447
D940,700 S *	1/2022	Yongren	.....	D14/447
2012/0187257 A1 *	7/2012	Zou	.....	F16M 11/041 248/125.8

**OTHER PUBLICATIONS**

Amazon.com\_ Saiji Adjustable Phone Stand, first available Nov. 7, 2019 [online], retrieved Jan. 24, 2023, available at URL: <https://a.co/d/dNRmNB7> (Year: 2019).\*

Amazon.com\_ Skejer Cell Phone Stand for Desk, first available Jun. 1, 2020 [online], retrieved Jan. 24, 2023, available at URL: <https://a.co/d/cVGju55> (Year: 2020).\*

\* cited by examiner

*Primary Examiner* — Wendy L Arminio

*Assistant Examiner* — Carrie S Gelula

(74) *Attorney, Agent, or Firm* — Knobbe Martens Olson & Bear LLP

(57) **CLAIM**

The ornamental design for a display stand, as shown and described.

**DESCRIPTION**

FIG. 1 is a front perspective view of the display stand embodying the new design;  
FIG. 2 is a back perspective view thereof;  
FIG. 3 is a front view thereof;  
FIG. 4 is a back view thereof;  
FIG. 5 is a left side view thereof;  
FIG. 6 is a right side view thereof;  
FIG. 7 is a top view thereof; and,  
FIG. 8 is a bottom view thereof.

**1 Claim, 8 Drawing Sheets**

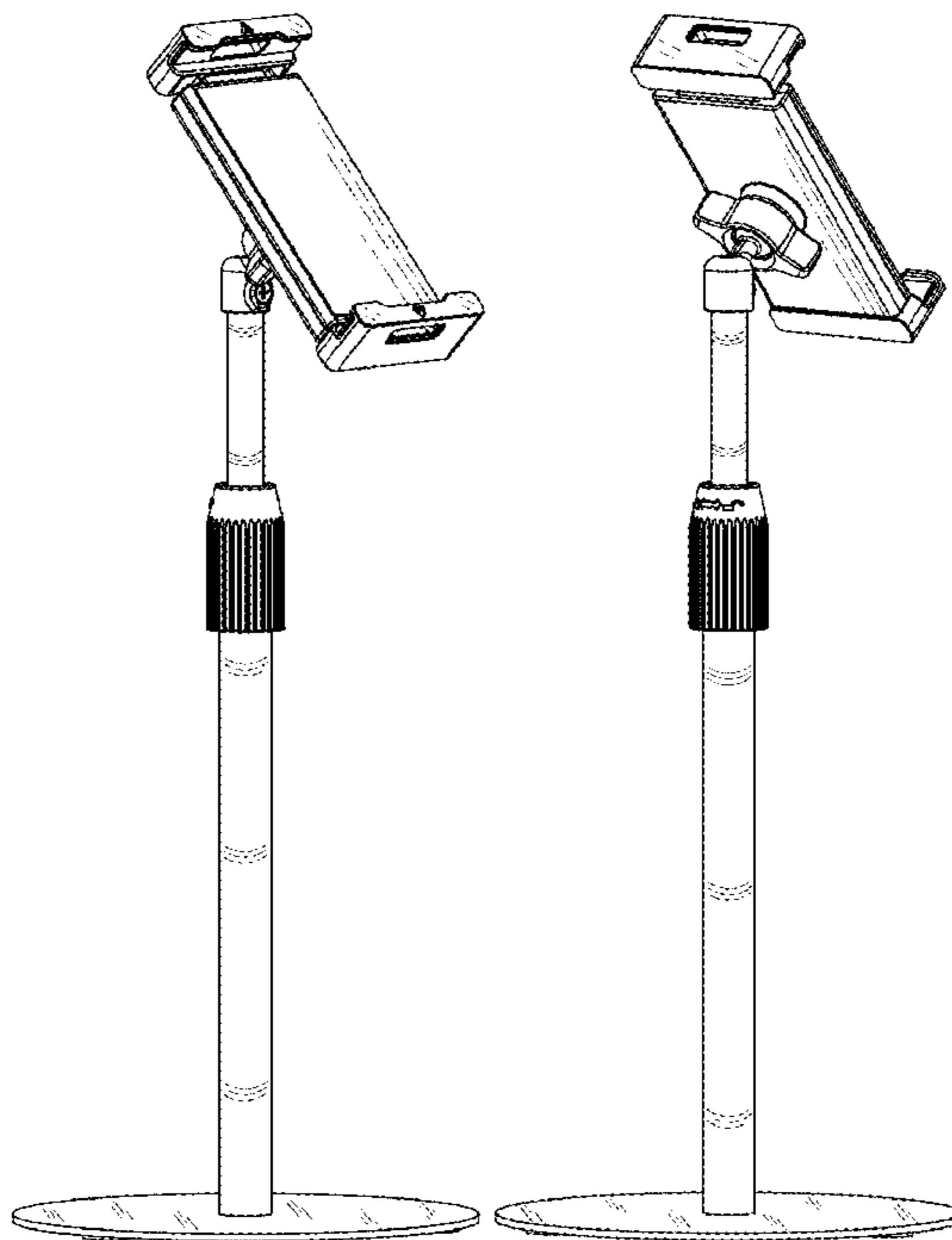

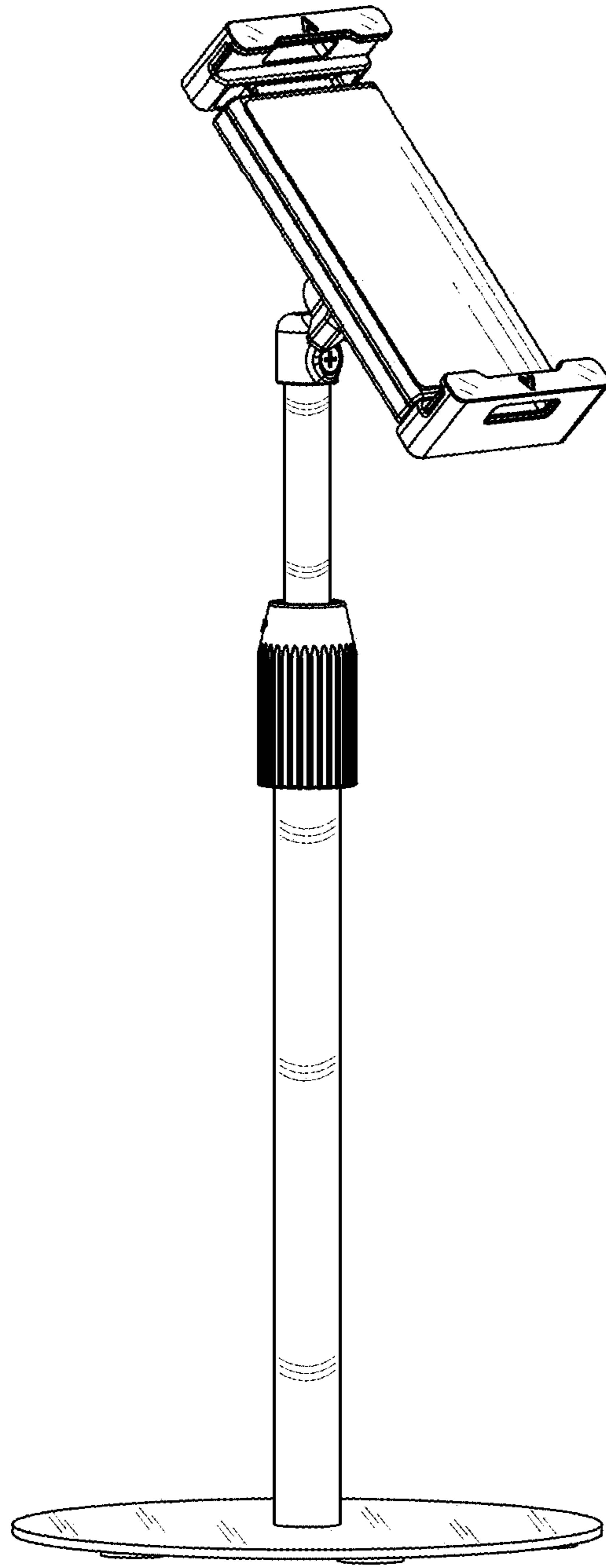

Fig.1

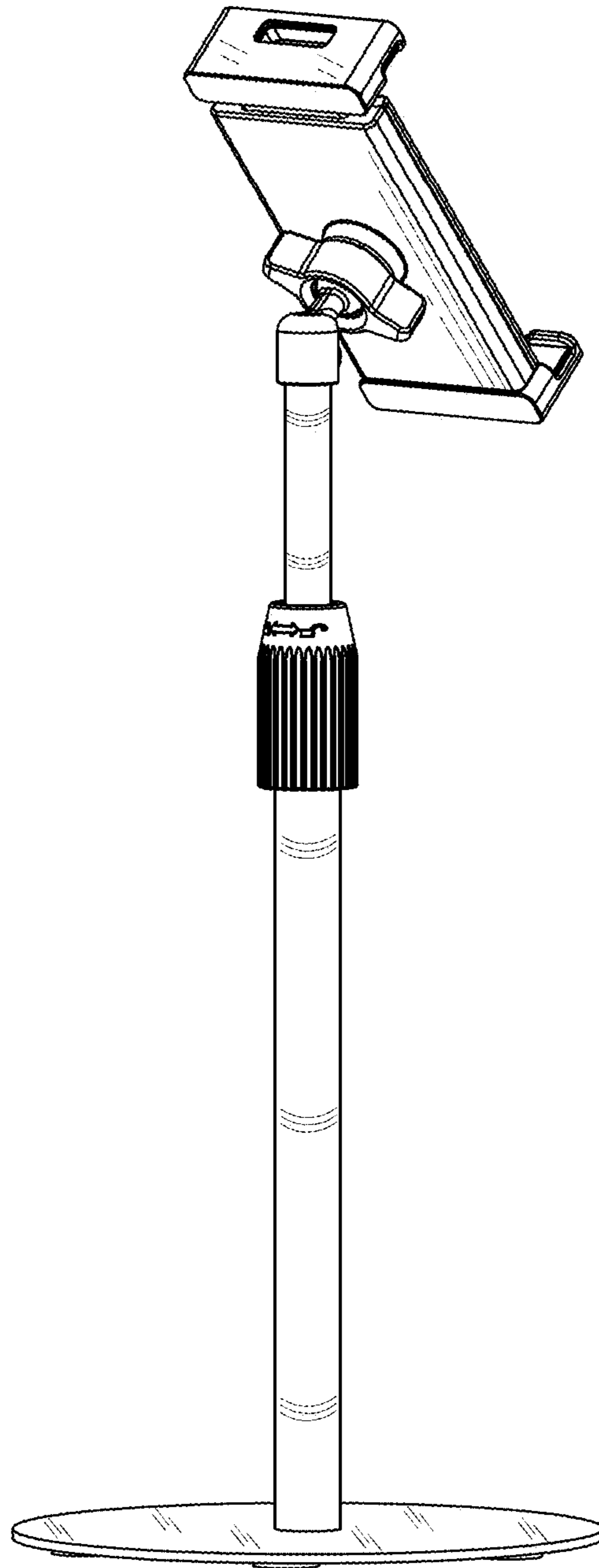

Fig.2

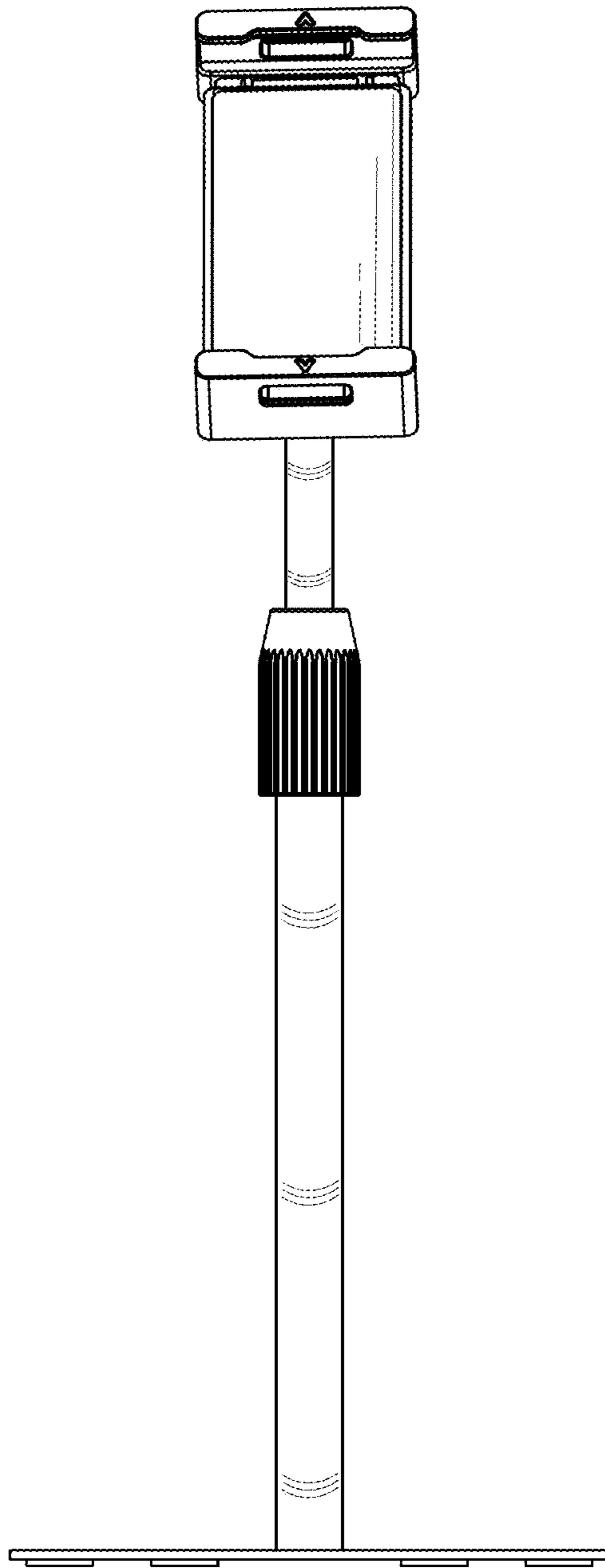

Fig.3

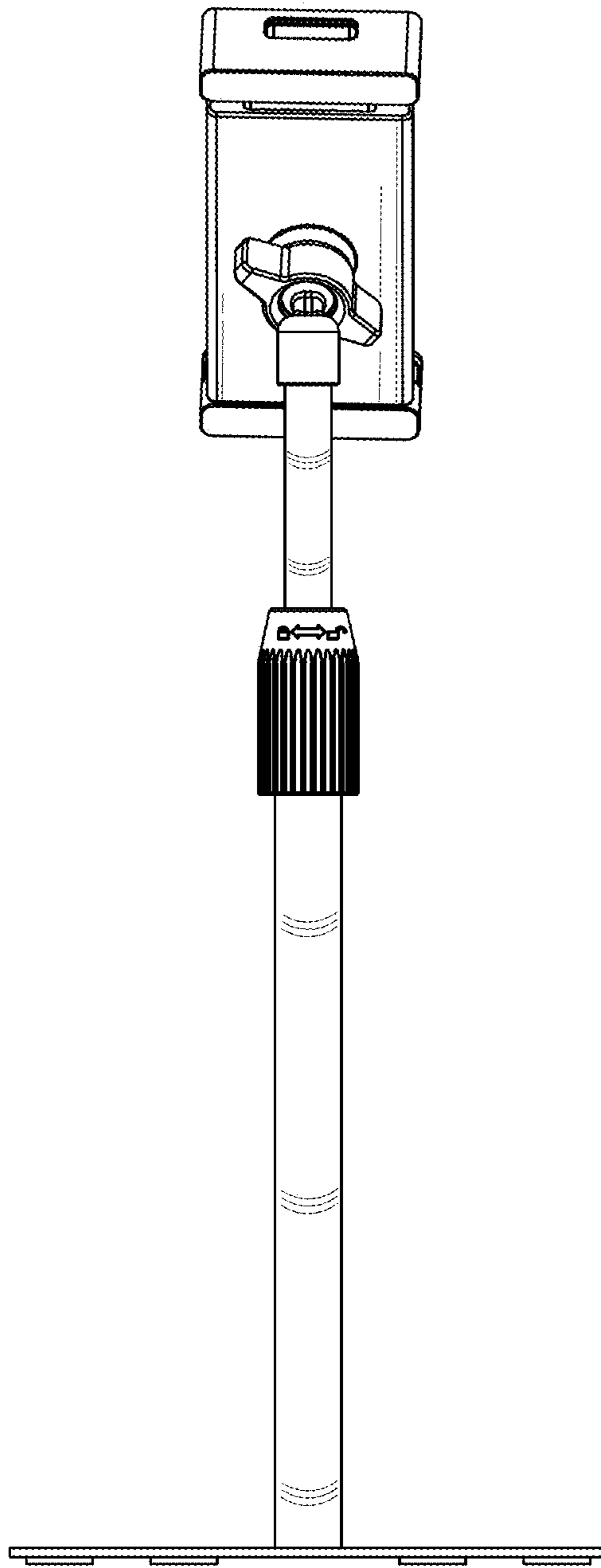

Fig.4

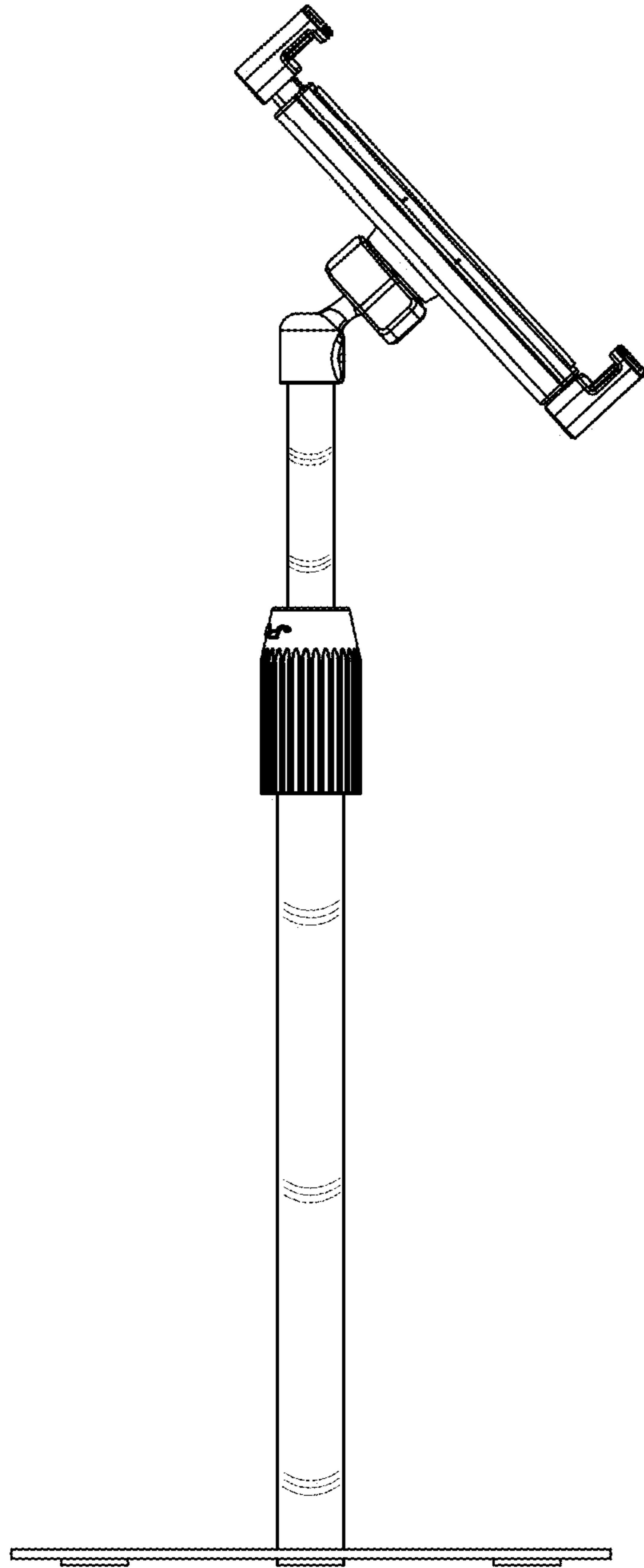

Fig.5

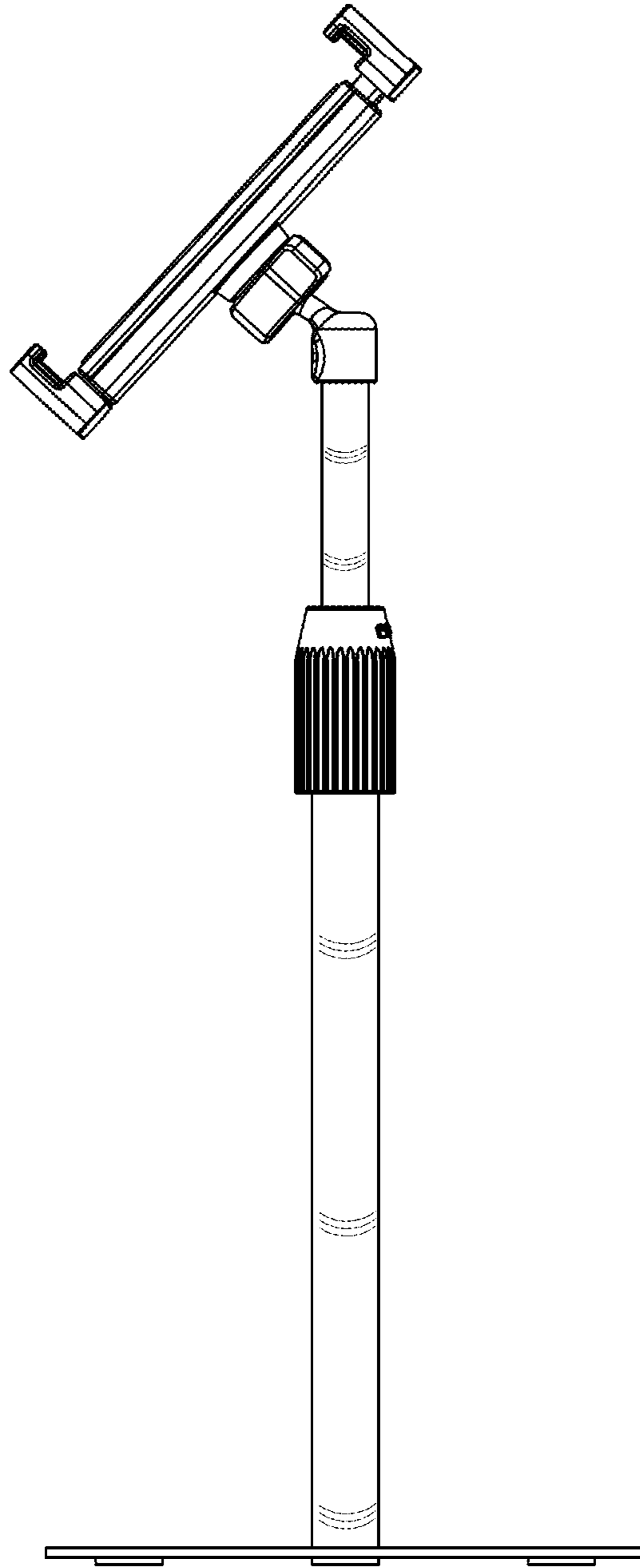

Fig.6

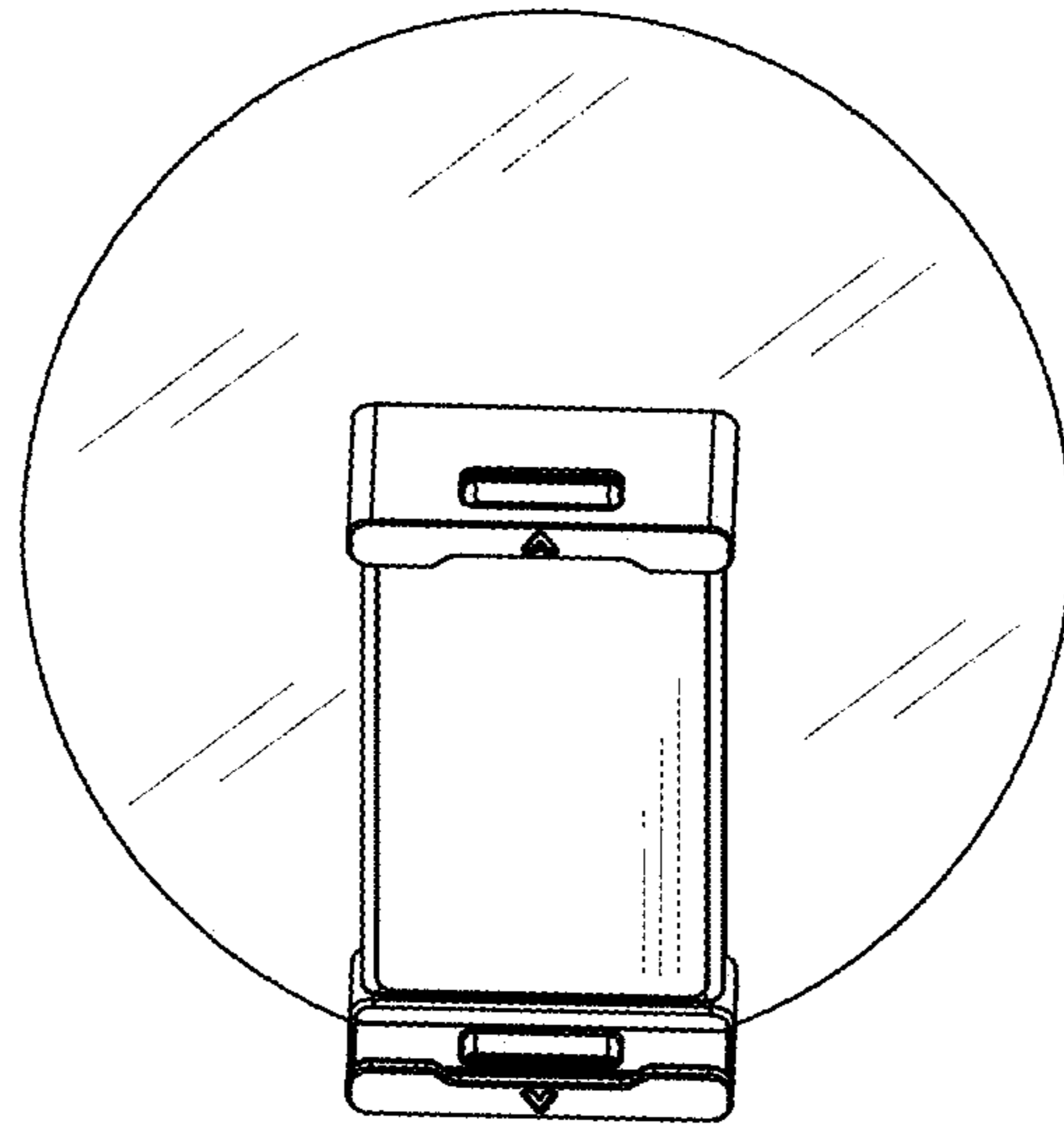

Fig.7



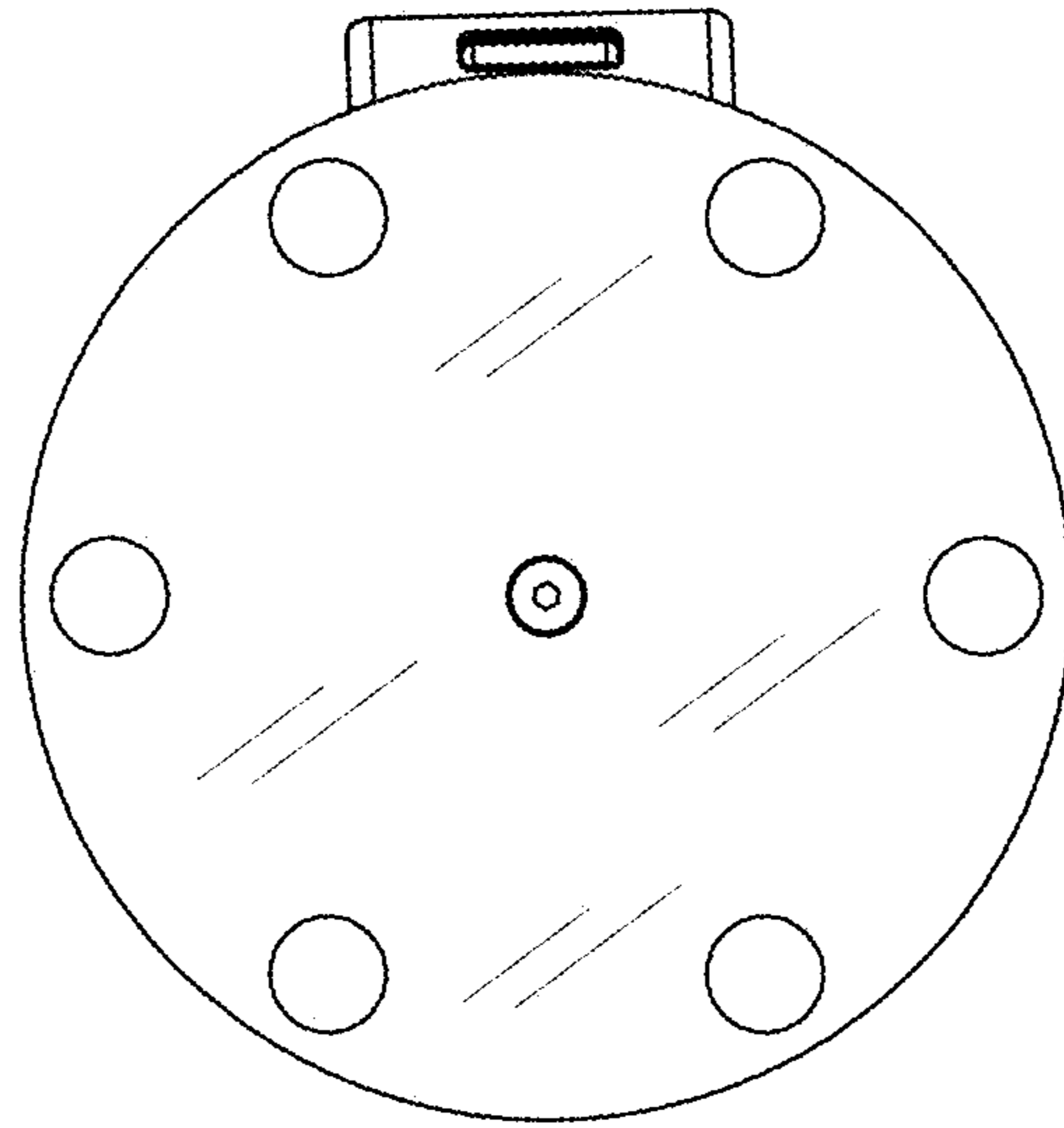

Fig.8