



US00D985557S

(12) **United States Design Patent**  
**Zhang**

(10) **Patent No.:** **US D985,557 S**  
(45) **Date of Patent:** **\*\* May 9, 2023**

(54) **SMART WATCH**

(71) Applicant: **Shenzhen Zhisuixing Electronic Technology Co., Ltd., Shenzhen (CN)**

(72) Inventor: **Jing Zhang, Shenzhen (CN)**

(\*\*) Term: **15 Years**

(21) Appl. No.: **29/847,178**

(22) Filed: **Jul. 22, 2022**

(30) **Foreign Application Priority Data**

Jul. 8, 2022 (EP) ..... 009082951-0001

(51) **LOC (14) Cl.** ..... **14-02**

(52) **U.S. Cl.**  
USPC ..... **D14/344**

(58) **Field of Classification Search**  
USPC ..... D14/138 R, 344; D10/30, 31, 32, 38;  
D11/1, 2, 3, 45, 6, 12, 13, 14, 15, 16, 20,  
D11/26; D24/167

CPC ..... G04G 17/00; G04G 17/045; G04G 17/08;  
G04G 17/083; G04G 21/00; G04G 21/02;  
G04G 21/025; G04G 21/06; G04G 21/08;  
G04G 99/006; G06F 1/163; A44C 5/022;  
A44C 5/025; A44C 5/0007; A44C  
5/0015; A44C 5/0046; A44C 5/0053;  
A44C 5/2052; A44C 5/2071; A44C 9/00;  
A44C 9/0053

See application file for complete search history.

(56) **References Cited**

**U.S. PATENT DOCUMENTS**

D629,703 S \* 12/2010 Giannini ..... D10/32  
D768,623 S \* 10/2016 Zou ..... D10/70  
D792,244 S \* 7/2017 Schaad ..... D10/37  
D795,088 S \* 8/2017 Monachon ..... D10/30  
D796,347 S \* 9/2017 Yoshida ..... D10/38  
D828,351 S \* 9/2018 Xie ..... D14/344  
D834,430 S \* 11/2018 Schaad ..... D10/30

D873,165 S \* 1/2020 Nyaggah ..... D11/5  
D873,696 S \* 1/2020 Nyaggah ..... D11/5  
D881,061 S \* 4/2020 Tang ..... D11/16

(Continued)

**OTHER PUBLICATIONS**

Nova Luna Smartwatch, www.www.lecouturenova.com, Accessed Nov. 15, 2022. [https://www.lecouturenova.com/products/nova-luna-smart-watch?variant=39569169678390&currency=USD&utm\\_medium=product\\_sync&utm\\_source=google&utm\\_content=sag\\_organic&utm\\_campaign=sag\\_organic&gclid=EAlalQobChMlieqTztmw-wlVgs3lCh3kWAWEeAsYBSABEgINk\\_D\\_BwE](https://www.lecouturenova.com/products/nova-luna-smart-watch?variant=39569169678390&currency=USD&utm_medium=product_sync&utm_source=google&utm_content=sag_organic&utm_campaign=sag_organic&gclid=EAlalQobChMlieqTztmw-wlVgs3lCh3kWAWEeAsYBSABEgINk_D_BwE) (Year: 2022).\*

(Continued)

*Primary Examiner* — Llorellys Martinez

*Assistant Examiner* — Kwabena A. Ankobiah

(74) *Attorney, Agent, or Firm* — Rumit Ranjit Kanakia

(57) **CLAIM**

The ornamental design for a smart watch, as shown and described.

**DESCRIPTION**

FIG. 1 is a first perspective view of a smart watch showing my new design;  
FIG. 2 is a second perspective view thereof;  
FIG. 3 is a front view thereof;  
FIG. 4 is a back view thereof;  
FIG. 5 is a left side view thereof;  
FIG. 6 is a right side view thereof;  
FIG. 7 is a top view thereof;  
FIG. 8 is a bottom view thereof;  
FIG. 9 is an enlarged view of the selected portion 9 in FIG. 1; and,  
FIG. 10 is an enlarged view of the selected portion 10 in FIG. 1.

The broken lines shown in the drawings depict portions of the smart watch that form no part of the claimed design. The dot-dash broken lines encircling a portion of the smart watch

(Continued)

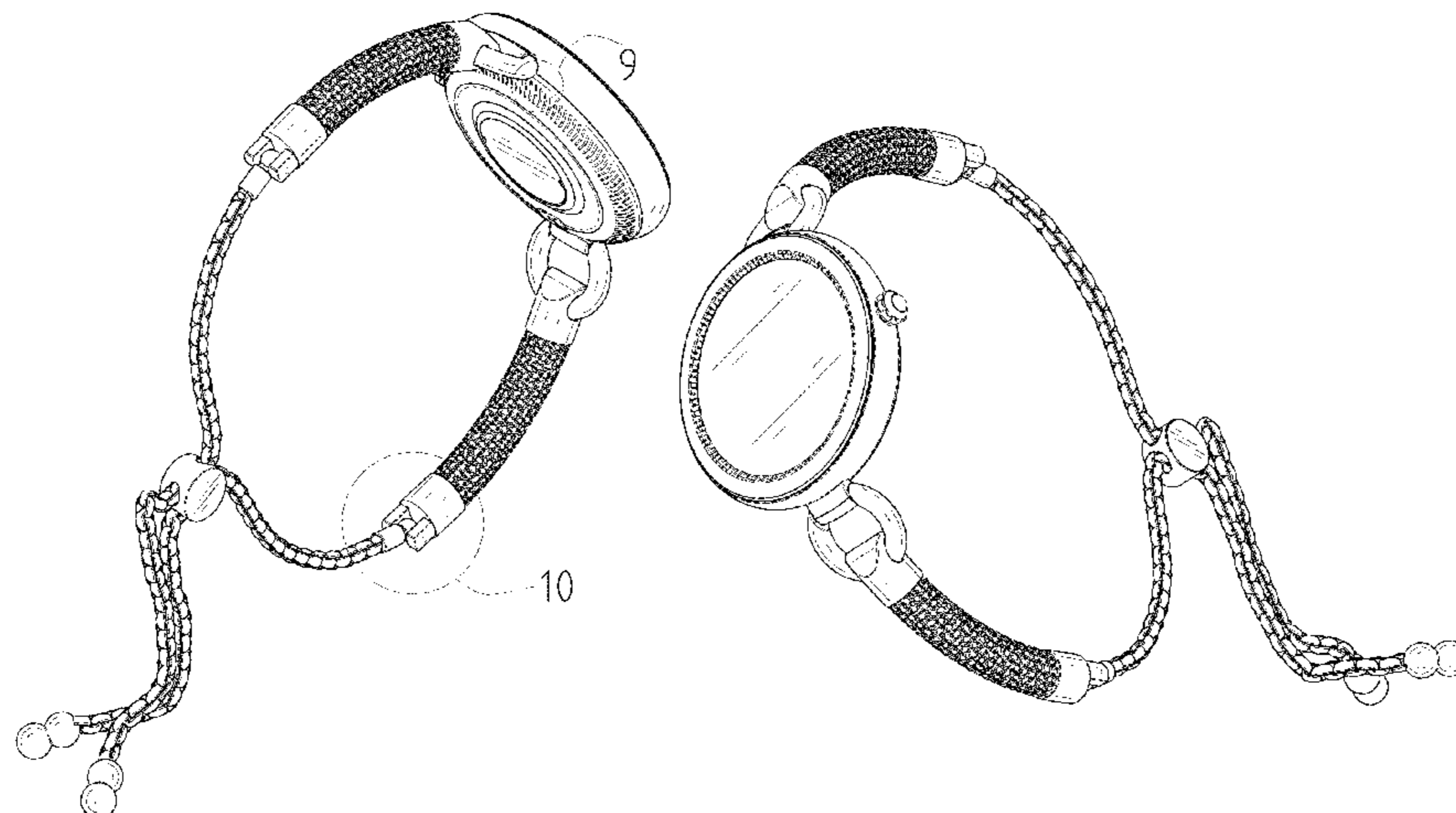

in FIGS. 1, 9, and 10 are included to show a partially enlarged view only and form no part of the claimed design.

**1 Claim, 10 Drawing Sheets**

(56)

**References Cited**

U.S. PATENT DOCUMENTS

D902,744 S	*	11/2020	Cazzola .....	D10/32
D931,115 S	*	9/2021	Nashimoto .....	D10/32
D933,651 S		10/2021	Cheng	
D934,860 S		11/2021	King et al.	
D935,453 S		11/2021	Gao	
D961,585 S	*	8/2022	He .....	D14/344
D966,134 S	*	10/2022	Li .....	D11/5
D972,433 S	*	12/2022	Zuo .....	D11/4

OTHER PUBLICATIONS

Beaded Bracelet for Fitbit Luxe Women, Handmade White Pearls Watch Band Replacement Straps for Fitbit Luxe Accessories, [www.amazon.com](https://www.amazon.com/Beaded-Bracelet-Handmade-Repalcement-Accessories/dp/B09C1M9D8S?th=1), Aug. 6, 2021. <https://www.amazon.com/Beaded-Bracelet-Handmade-Repalcement-Accessories/dp/B09C1M9D8S?th=1> (Year: 2021).\*

Gen 5E Darci Pavé Two-Tone Smartwatch, [www.michaelkors.com](https://www.michaelkors.com), Accessed Nov. 15, 2022. [https://www.michaelkors.com/product/gen-5e-darci-pave-two-tone-smartwatch/\\_/R-US\\_MKT5129V?colorExplode=true&skuId=648354757&source=googleshopping&cid=MKC\\_PLA\\_P\\_GG\\_X\\_US\\_EN\\_Watches\\_Womens\\_Smart\\_11568840872\\_111133888245\\_pla-898040272936&utm\\_source=google&utm\\_medium=cpc&adpos=&scid=scplp648354757&sc\\_intid=648354757&gclid=EA1a1QobChMI17\\_Hvt2w-wIV18DICH1AkAfMEAkYByABEgI8tvD\\_BwE&gclsrc=aw.ds](https://www.michaelkors.com/product/gen-5e-darci-pave-two-tone-smartwatch/_/R-US_MKT5129V?colorExplode=true&skuId=648354757&source=googleshopping&cid=MKC_PLA_P_GG_X_US_EN_Watches_Womens_Smart_11568840872_111133888245_pla-898040272936&utm_source=google&utm_medium=cpc&adpos=&scid=scplp648354757&sc_intid=648354757&gclid=EA1a1QobChMI17_Hvt2w-wIV18DICH1AkAfMEAkYByABEgI8tvD_BwE&gclsrc=aw.ds) (Year: 2022).\*

\* cited by examiner

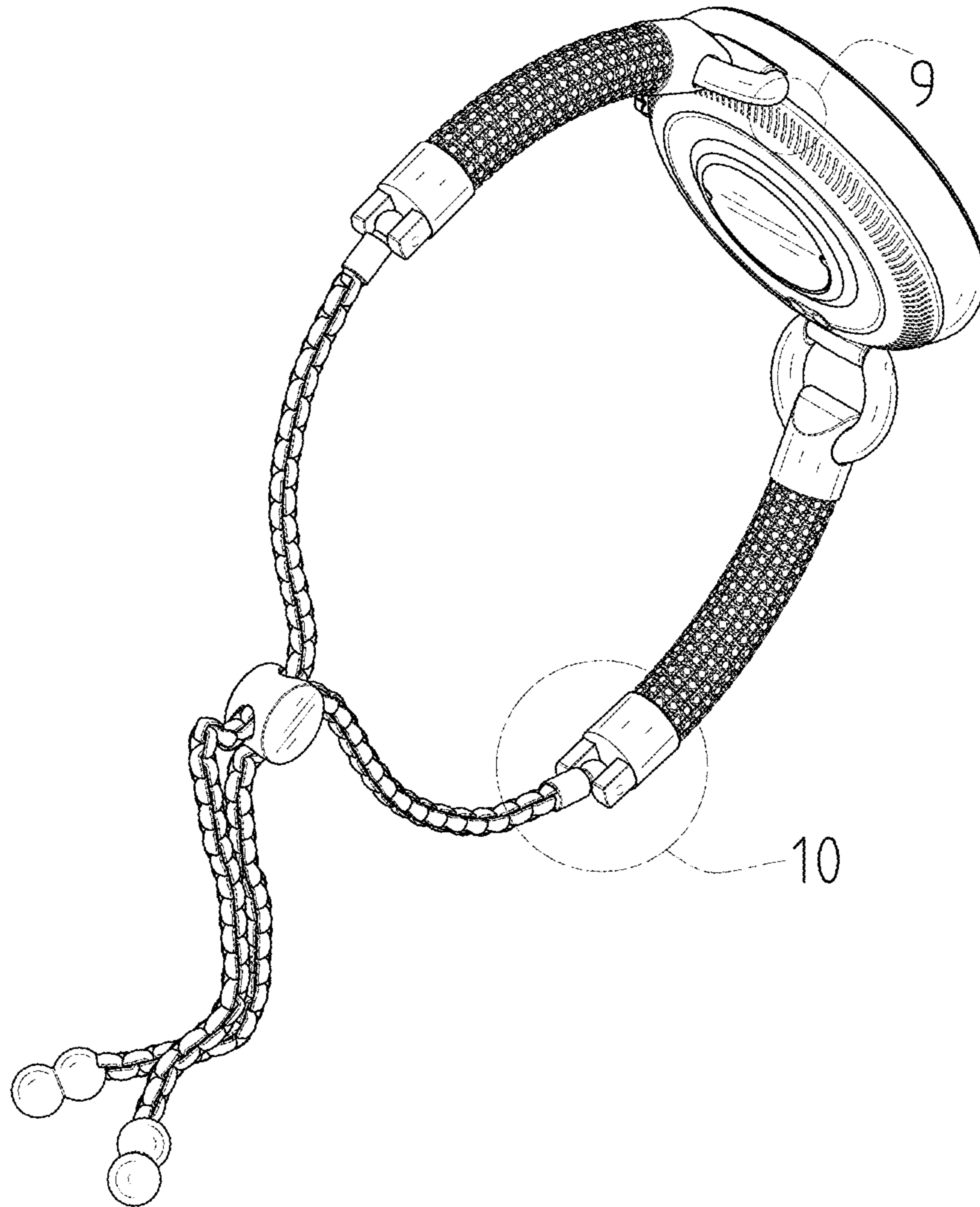

FIG. 1

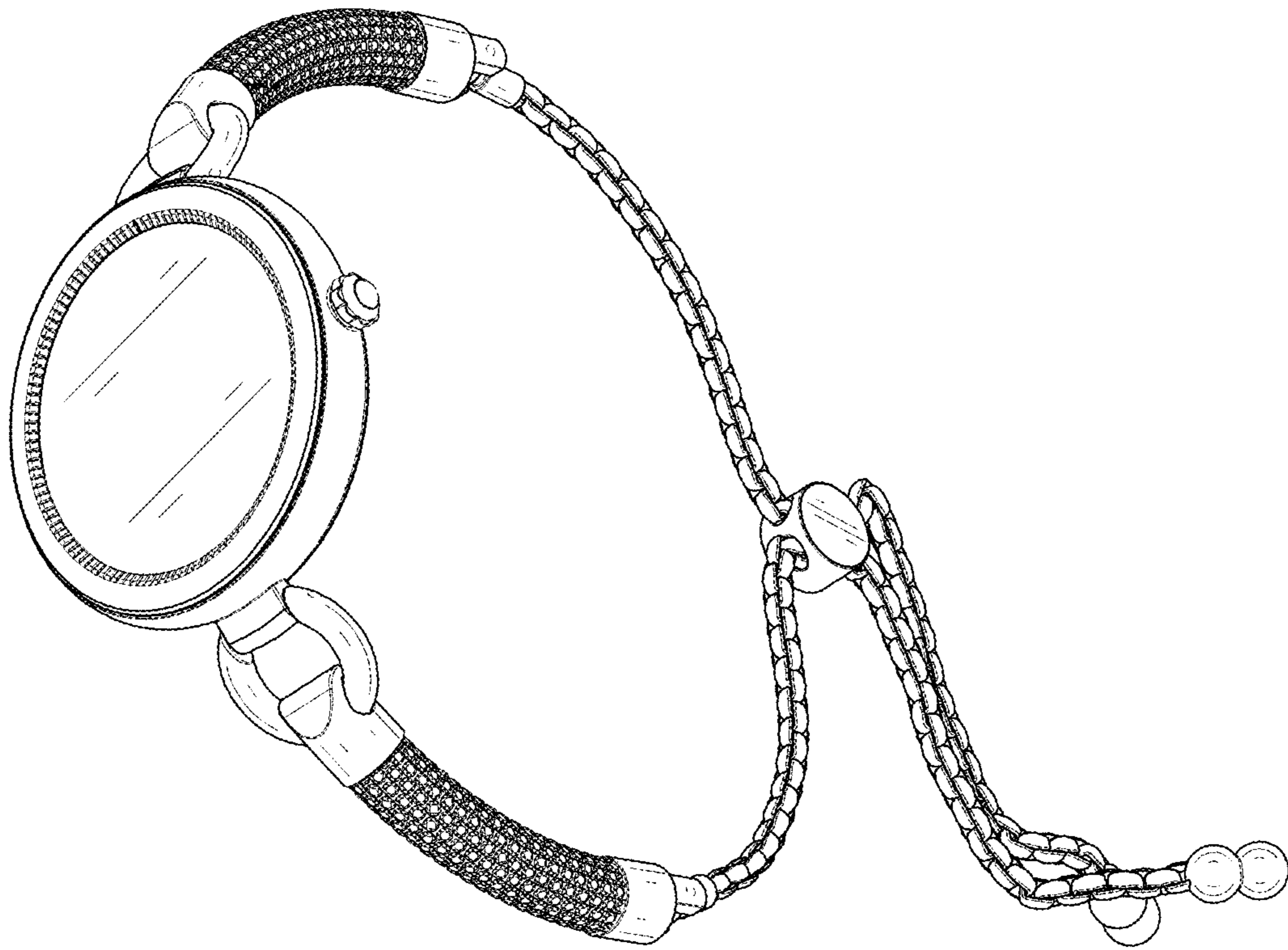

FIG. 2

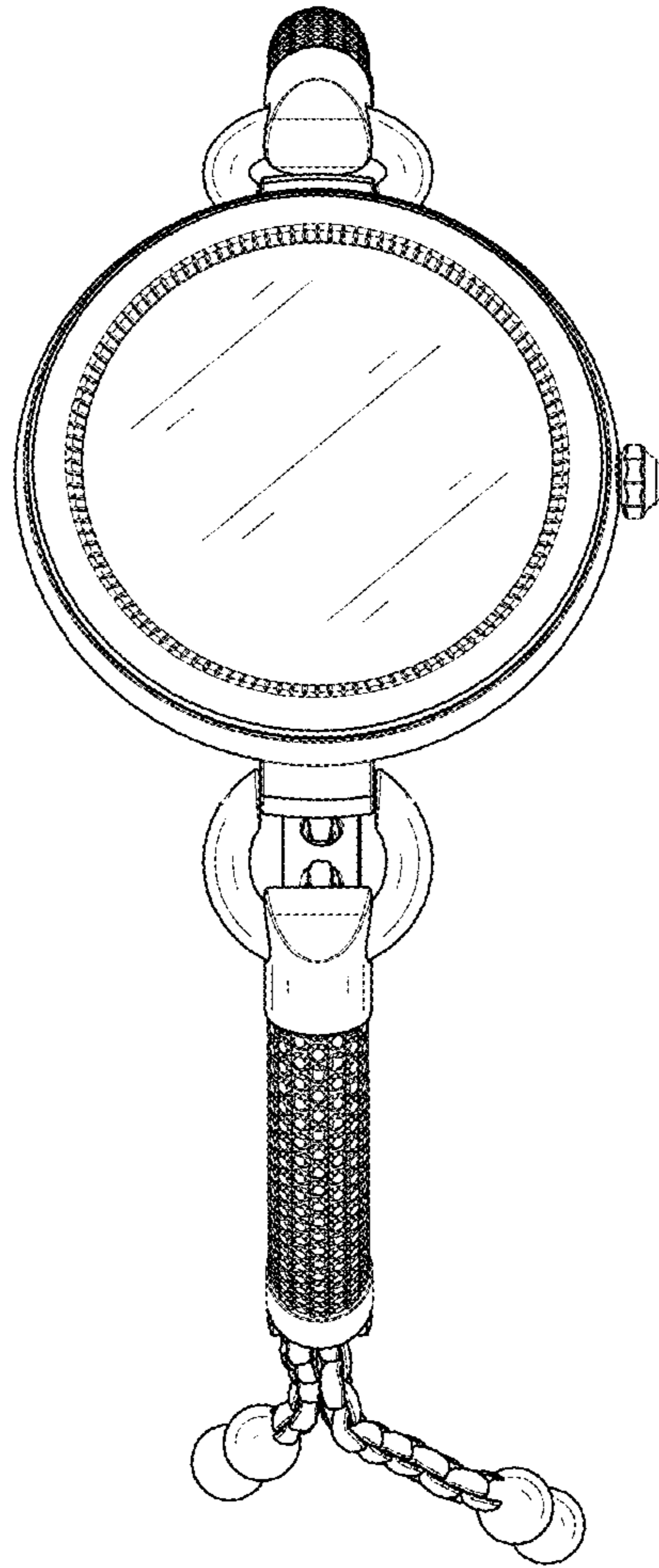

FIG. 3

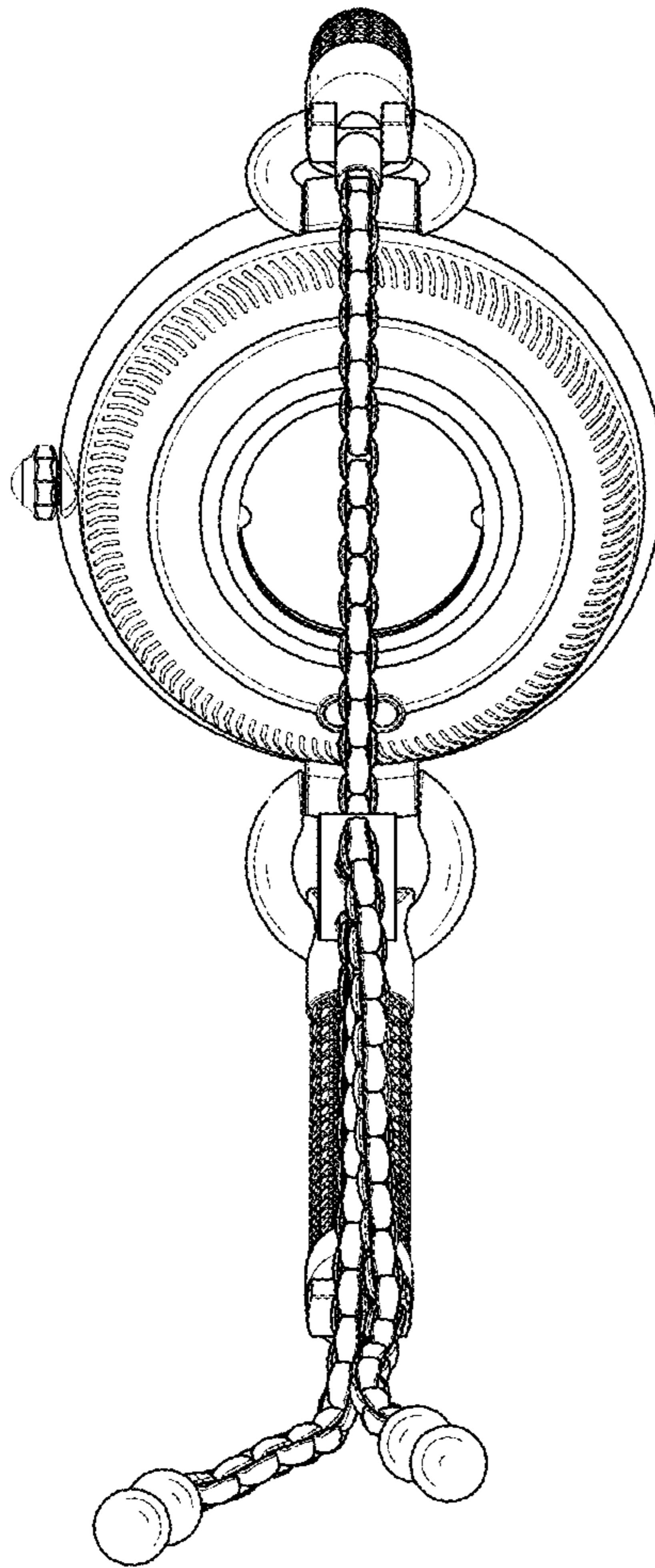

FIG. 4

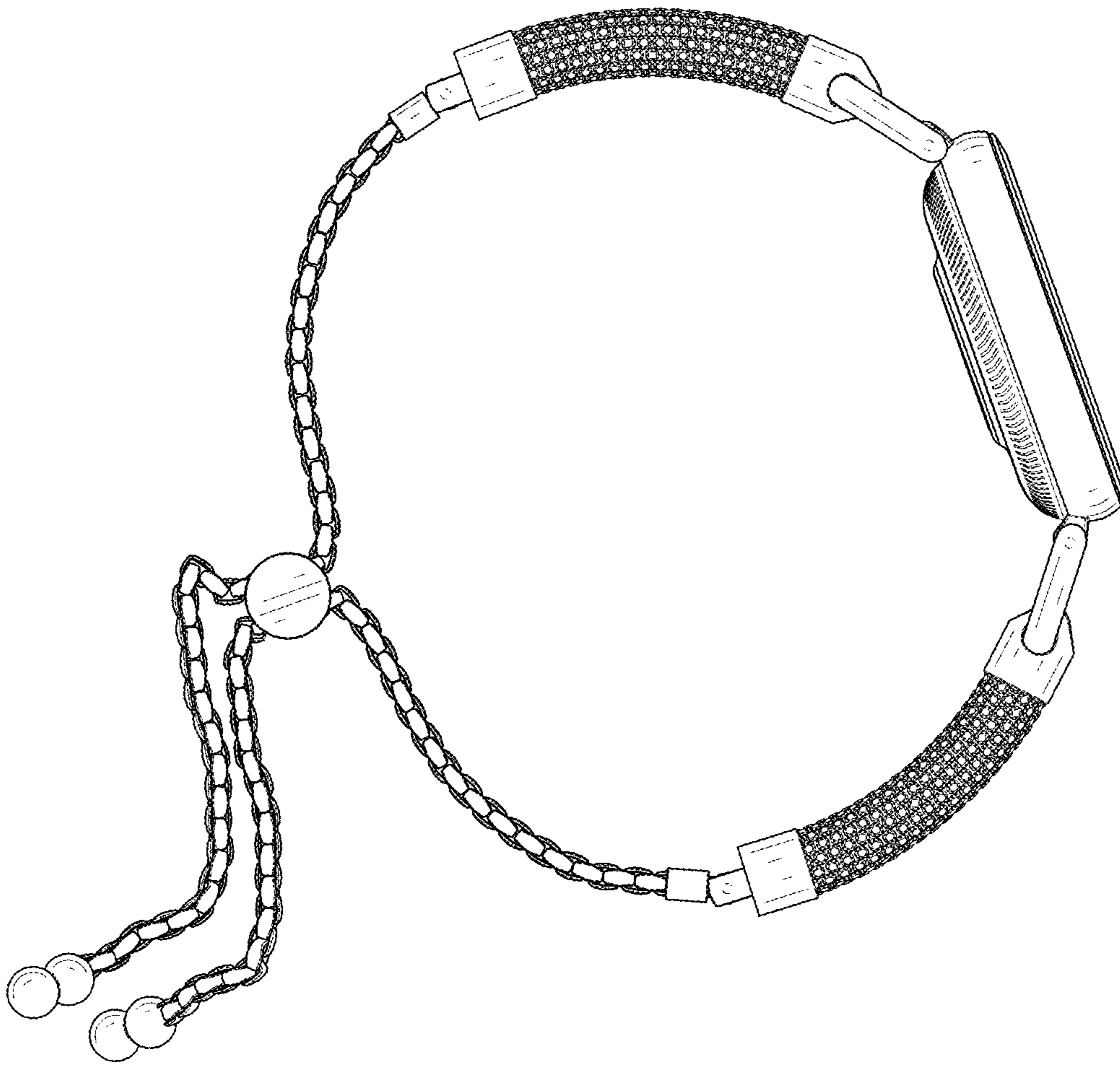

FIG. 5

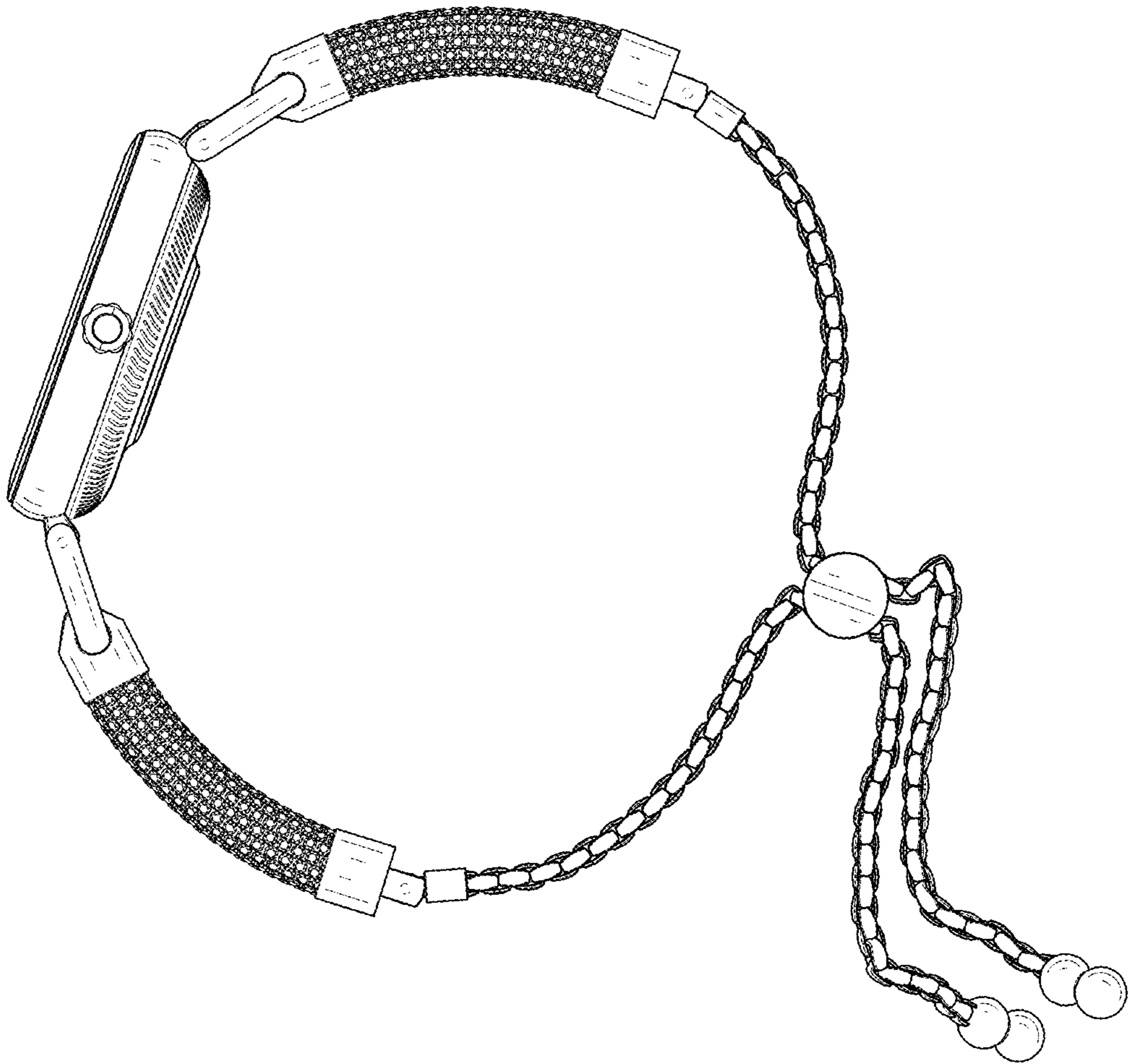

FIG. 6



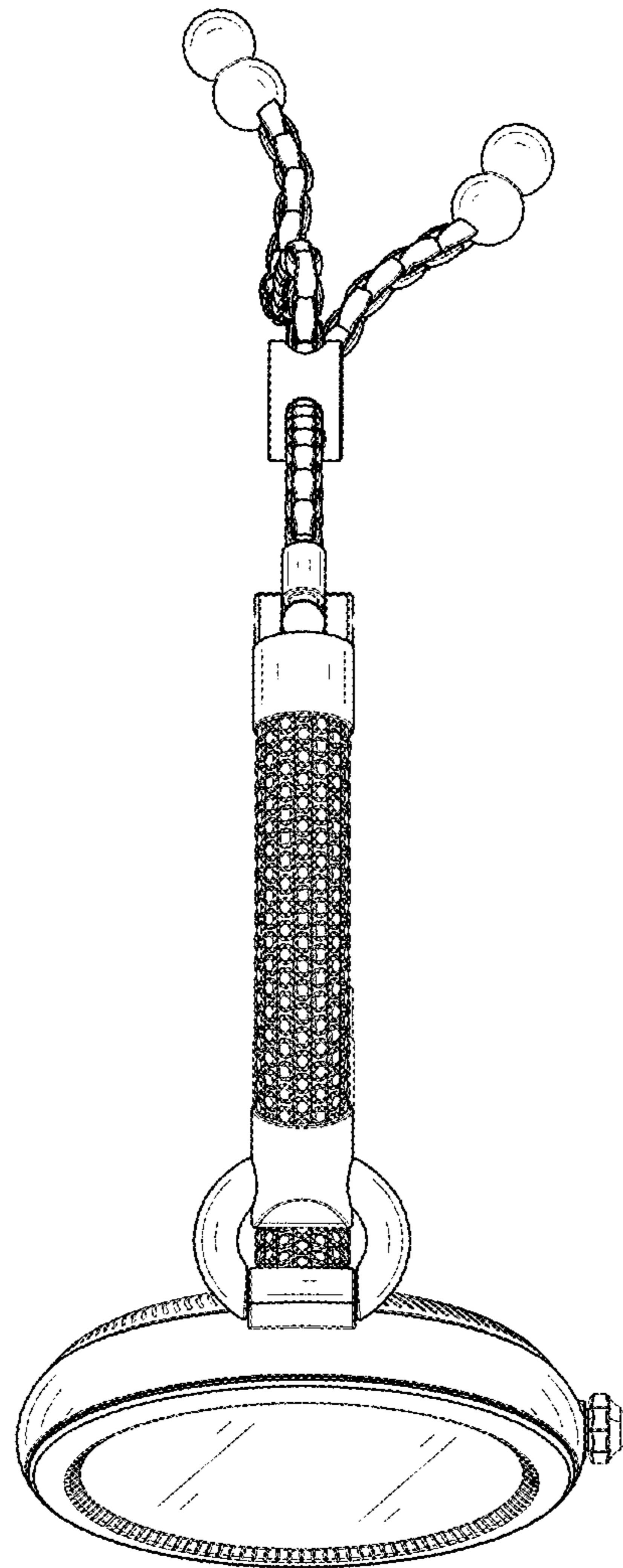

FIG. 7

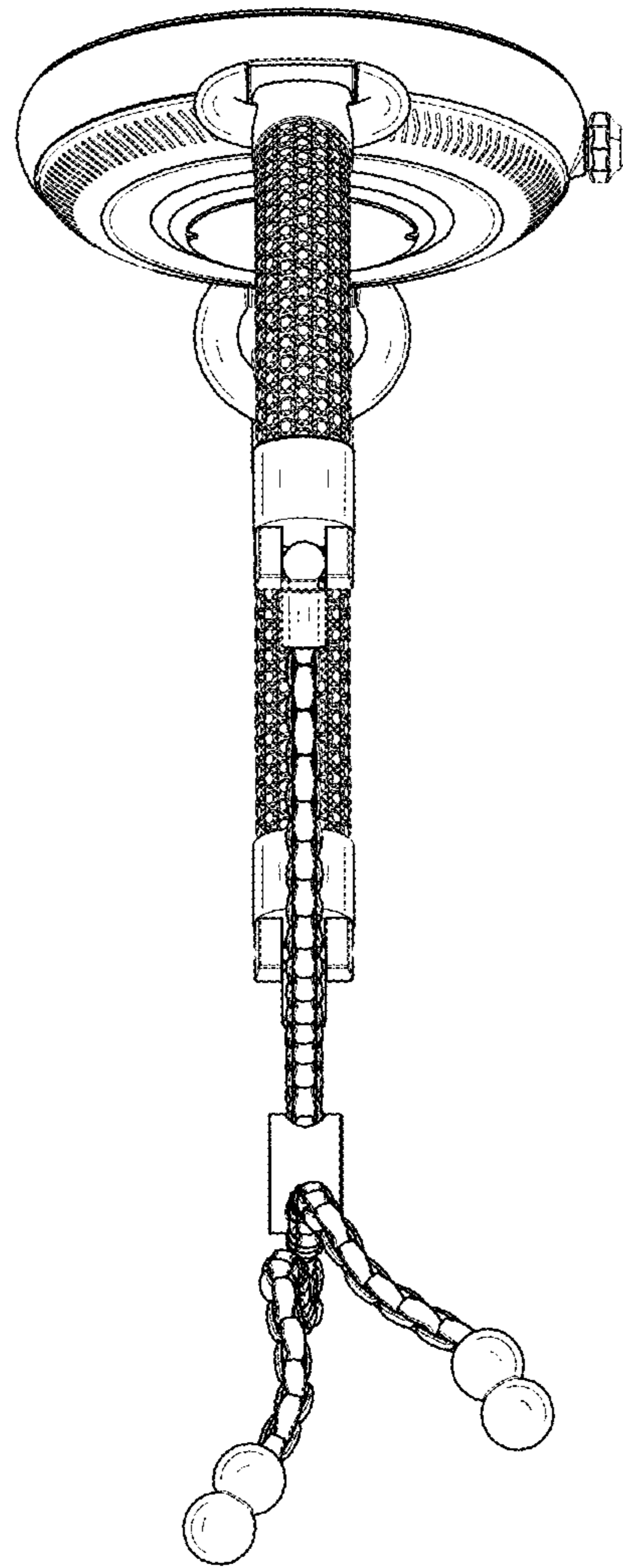

FIG. 8

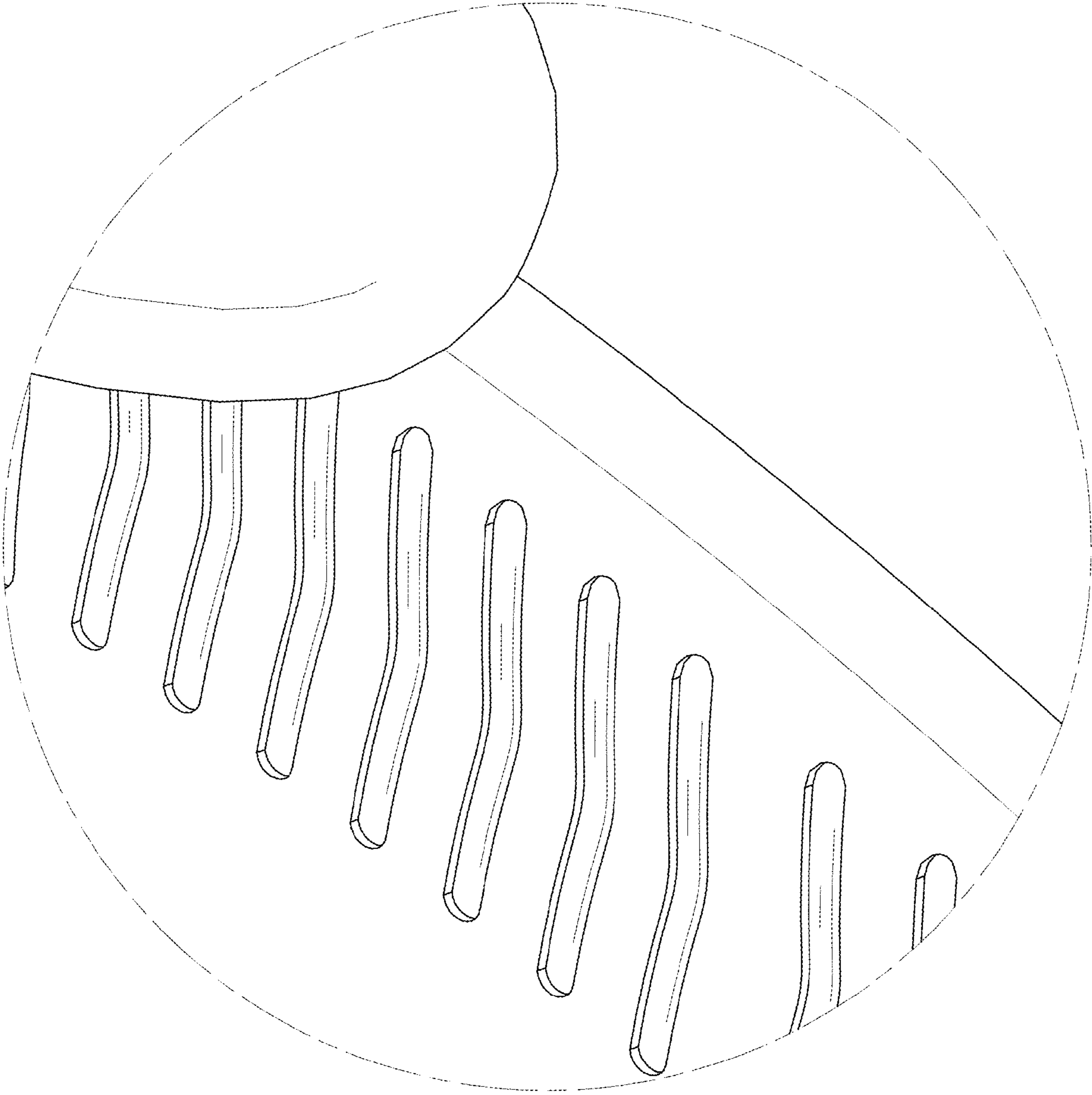

FIG. 9

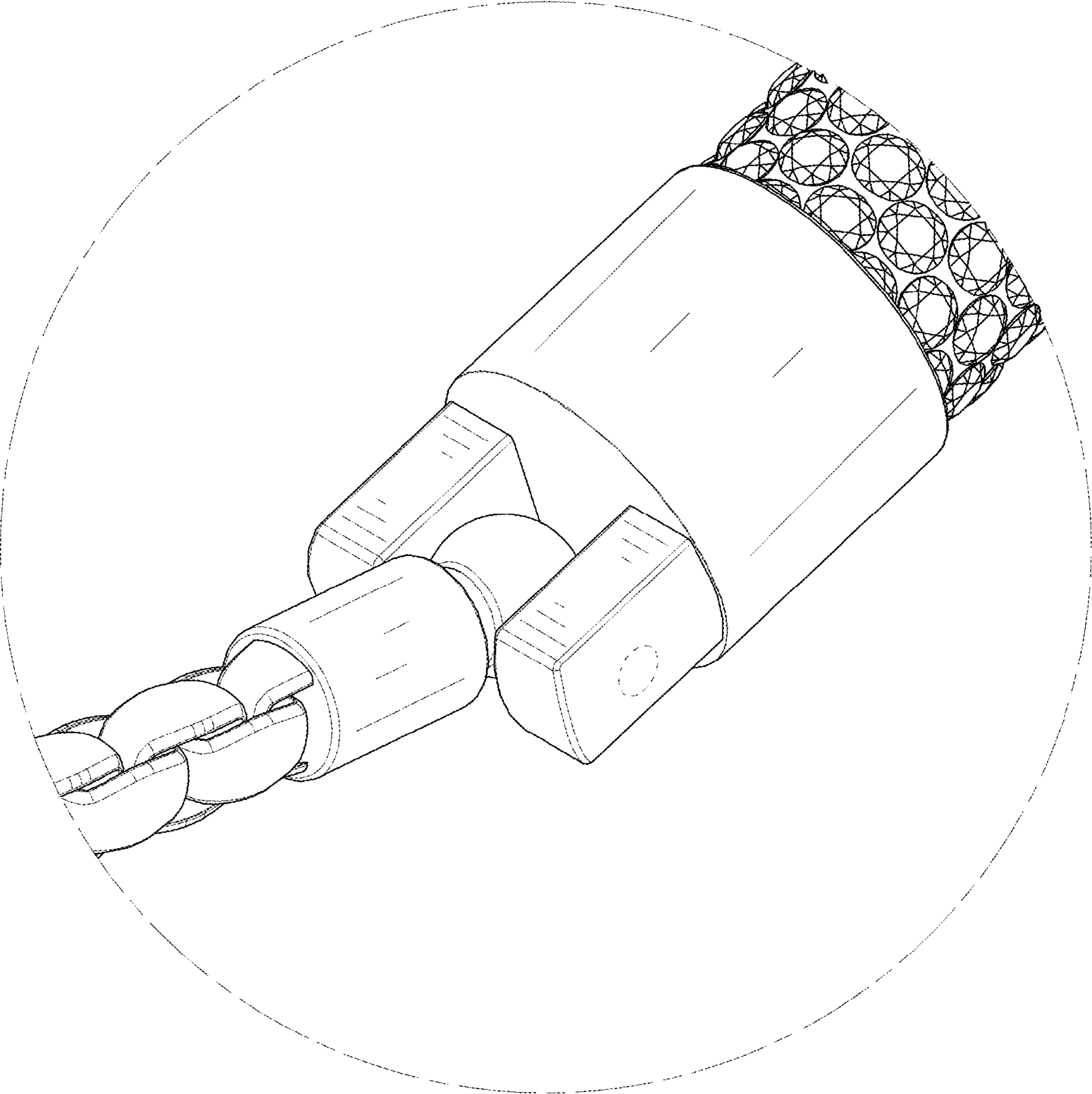

FIG. 10