



US00D985552S

(12) **United States Design Patent** (10) **Patent No.:** **US D985,552 S**
Akana et al. (45) **Date of Patent:** **** May 9, 2023**

(54) **ELECTRONIC DEVICE**

(71) Applicant: **Apple Inc.**, Cupertino, CA (US)

(72) Inventors: **Jody Akana**, Los Altos Hills, CA (US); **Molly Anderson**, San Francisco, CA (US); **Bartley K. Andre**, Palo Alto, CA (US); **Shota Aoyagi**, San Francisco, CA (US); **Anthony Michael Ashcroft**, San Francisco, CA (US); **Marine C. Bataille**, San Francisco, CA (US); **Jeremy Bataillou**, San Francisco, CA (US); **Markus Diebel**, San Francisco, CA (US); **M. Evans Hankey**, San Francisco, CA (US); **Julian Hoenig**, San Francisco, CA (US); **Richard P. Howarth**, San Francisco, CA (US); **Jonathan P. Ive**, San Francisco, CA (US); **Julian Jaede**, San Francisco, CA (US); **Duncan Robert Kerr**, San Francisco, CA (US); **Peter Russell-Clarke**, San Francisco, CA (US); **Benjamin Andrew Shaffer**, San Jose, CA (US); **Mikael Silvanto**, San Francisco, CA (US); **Sung-Ho Tan**, Vienna (AT); **Clement Tissandier**, San Francisco, CA (US); **Eugene Antony Whang**, San Francisco, CA (US); **Rico Zörkendörfer**, San Francisco, CA (US)

(73) Assignee: **Apple Inc.**, Cupertino, CA (US)

(**) Term: **15 Years**

(21) Appl. No.: **29/854,314**

(22) Filed: **Sep. 23, 2022**

Related U.S. Application Data

(63) Continuation of application No. 29/656,623, filed on Jul. 13, 2018, now Pat. No. Des. 964,985.

(51) **LOC (14) Cl.** **14-02**

(52) **U.S. Cl.**
USPC **D14/341**

(58) **Field of Classification Search**

USPC D14/138 AA, 138 AB, 138 AC, 138 AD, D14/138 C, 138 G, 248, 315–318, D14/341–347, 371, 374, 432, 439; D6/308, 310; D10/50, 65, 104.1; D18/6–7; D19/26, 59–60; D21/324, D21/329–330, 332

CPC ... H04M 1/0202; H04M 1/0266; H04M 1/725

See application file for complete search history.

(56) **References Cited**

U.S. PATENT DOCUMENTS

D264,969 S	6/1982	McGourty
4,976,435 A	12/1990	Shatford et al.
5,192,082 A	3/1993	Inoue et al.
D337,569 S	7/1993	Kando
D345,346 S	3/1994	Alfonso et al.
D349,923 S	8/1994	Billings et al.
D357,919 S	5/1995	Tsui
D359,306 S	6/1995	Lande et al.
D362,272 S	9/1995	Luong
D362,461 S	9/1995	Luong
D378,686 S	4/1997	Proctor et al.
5,661,632 A	8/1997	Register
D385,299 S	10/1997	Adams
D386,521 S	11/1997	Eisenbaum
D396,452 S	7/1998	Naruki et al.
D399,526 S	10/1998	Brady
D402,310 S	12/1998	Hendricks
D410,028 S	5/1999	Fyffe
D412,940 S	8/1999	Kato et al.
5,964,661 A	12/1999	Dodge
D425,558 S	5/2000	Tarpenning et al.
D430,117 S	8/2000	Sachs et al.
D430,169 S	8/2000	Scibora
D437,860 S	2/2001	Suzuki et al.
D445,787 S	7/2001	Francis
6,254,477 B1	7/2001	Sasaki et al.
D448,810 S	10/2001	Goto
D449,606 S	10/2001	Lee et al.
D450,713 S	11/2001	Masamitsu et al.
D451,505 S	12/2001	Iseki et al.
D452,250 S	12/2001	Chan
D453,333 S	2/2002	Chen
D458,252 S	6/2002	Palm et al.
D469,109 S	1/2003	Andre et al.
D472,245 S	3/2003	Andre et al.
D481,036 S	10/2003	Wentt
D481,718 S	11/2003	Chiang et al.

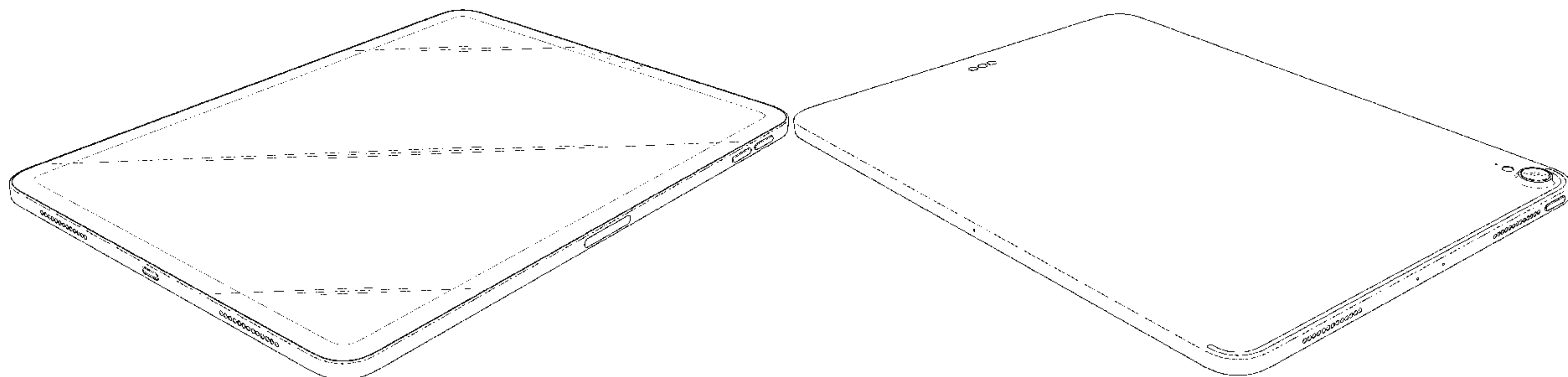

US D985,552 S

D483,809 S	12/2003	Lim	D708,608 S	7/2014	Sugiyama et al.
D486,823 S	2/2004	Kuo	8,804,353 B2	8/2014	Montevirgen et al.
D487,457 S	3/2004	Liu	D712,384 S	9/2014	Hibi
D487,742 S	3/2004	Huang et al.	D712,405 S	9/2014	Akana et al.
D489,717 S	5/2004	Hsieh	D713,833 S	9/2014	Wilkey
D490,420 S	5/2004	Solomon et al.	D716,250 S	10/2014	Becker et al.
D491,933 S	6/2004	Guo	D720,747 S	1/2015	Kim et al.
D491,936 S	6/2004	Jao	D723,495 S	3/2015	Jeong
D494,164 S	8/2004	Wu et al.	D731,481 S	6/2015	Akana et al.
D497,618 S	10/2004	Andre et al.	D732,498 S	6/2015	Huang et al.
D504,889 S *	5/2005	Andre D14/341	D745,004 S	12/2015	Kim
D548,732 S	8/2007	Cebe et al.	D750,620 S	3/2016	Zhai
D558,756 S	1/2008	Andre et al.	D752,036 S	3/2016	Ho et al.
D558,757 S	1/2008	Andre et al.	D753,103 S	4/2016	Yokoyama
D558,758 S	1/2008	Andre et al.	D756,952 S	5/2016	Simonian et al.
D569,837 S	5/2008	Baik et al.	D759,008 S	6/2016	Akana et al.
D573,143 S	7/2008	Park et al.	D764,431 S	8/2016	Hibi
D580,387 S	11/2008	Andre et al.	D767,522 S	9/2016	Wu et al.
D585,411 S	1/2009	Eaton	D770,433 S	11/2016	Kangasmaa et al.
D597,067 S	7/2009	Oh et al.	D771,620 S	11/2016	Kim et al.
D599,342 S	9/2009	Andre et al.	D771,622 S	11/2016	Akana et al.
D600,241 S	9/2009	Andre et al.	D774,031 S *	12/2016	Otani D14/341
D601,105 S	9/2009	Morabito	D778,904 S	2/2017	Akana et al.
D602,014 S	10/2009	Andre et al.	D781,807 S	3/2017	Hubbard et al.
D602,015 S	10/2009	Andre et al.	D783,602 S	4/2017	Akana et al.
D602,017 S	10/2009	Andre et al.	D786,238 S *	5/2017	Roberts D14/341
D602,488 S	10/2009	Jiang et al.	D789,924 S	6/2017	Akana et al.
D604,297 S	11/2009	Andre et al.	D790,535 S	6/2017	Akana et al.
7,697,281 B2	4/2010	Dabov et al.	D791,732 S	7/2017	Xu et al.
D617,751 S	6/2010	Lee et al.	D792,366 S	7/2017	Zhang et al.
D617,762 S	6/2010	Hong et al.	D800,716 S	10/2017	Akana et al.
D618,204 S	6/2010	Andre et al.	D801,330 S	10/2017	Morgan
D619,555 S	7/2010	Yang et al.	D806,705 S	1/2018	Akana et al.
D622,270 S	8/2010	Andre et al.	D808,957 S	1/2018	Tian
D622,718 S	8/2010	Andre et al.	D816,649 S *	5/2018	Song D14/248
D622,719 S	8/2010	Andre et al.	D825,555 S	8/2018	Lee et al.
D625,307 S	10/2010	Cheng	D834,553 S	11/2018	Depape et al.
D626,937 S	11/2010	Yeo et al.	D835,097 S	12/2018	Morgan
D627,344 S	11/2010	Chien et al.	D837,189 S	1/2019	Cui et al.
D627,778 S	11/2010	Akana et al.	D837,190 S	1/2019	Mahonen et al.
D636,390 S	4/2011	Andre et al.	D837,191 S	1/2019	Mahonen et al.
D636,752 S	4/2011	Liao et al.	D839,266 S	1/2019	Chang et al.
D638,003 S	5/2011	Chen	D845,294 S	4/2019	Akana et al.
D638,815 S	5/2011	Lee et al.	D859,397 S *	9/2019	Akana D14/341
D639,261 S	6/2011	Garnham et al.	D867,359 S	11/2019	Akana et al.
D639,763 S	6/2011	Kim et al.	D869,459 S	12/2019	Wan
D639,771 S	6/2011	Chen	D870,100 S	12/2019	Li et al.
D640,663 S	6/2011	Arnholt et al.	D878,376 S *	3/2020	Claudepierre D14/440
D642,563 S	8/2011	Akana et al.	D893,493 S *	8/2020	Akana D14/439
D648,303 S	11/2011	Park et al.	D894,882 S	9/2020	Kim et al.
D648,305 S	11/2011	Chen	D905,050 S	12/2020	Kim et al.
D649,968 S	12/2011	Li	D907,035 S *	1/2021	Kim G06F 1/1613
D656,477 S	3/2012	Yi et al.			D14/341
D662,503 S	6/2012	Akana et al.	D909,388 S *	2/2021	Akana D14/439
D668,650 S	10/2012	Han	D917,464 S *	4/2021	Kang D14/341
D669,069 S	10/2012	Akana et al.	D922,372 S	6/2021	Ham
D669,468 S	10/2012	Akana et al.	D922,373 S *	6/2021	Yeo D14/341
D673,562 S	1/2013	Johnson	D923,619 S	6/2021	Matsumoto et al.
D677,658 S	3/2013	Akana et al.	D926,771 S *	8/2021	Akana D14/439
D681,032 S	4/2013	Akana et al.	D944,241 S *	2/2022	Yum D14/341
D681,632 S	5/2013	Akana et al.	D945,414 S	3/2022	Cheng
D684,571 S	6/2013	Akana et al.	D947,838 S *	4/2022	Akana D14/341
D686,586 S	7/2013	Cho et al.	D954,047 S *	6/2022	Yum D14/341
D687,404 S	8/2013	Yoshimura	D964,985 S *	9/2022	Akana D14/341
D688,218 S	8/2013	Lee	2011/0050560 A1	3/2011	Foster et al.
D689,455 S	9/2013	Daniel	2011/0164365 A1	7/2011	McClure et al.
8,526,180 B2	9/2013	Rayner	2013/0162569 A1	6/2013	Sudo
8,535,075 B1	9/2013	Golko et al.	2014/0284096 A1	9/2014	Wu et al.
D695,704 S	12/2013	Kim et al.	2018/0110143 A1 *	4/2018	Zhao H04B 1/3816
D695,737 S	12/2013	Kim et al.			
D697,911 S	1/2014	McManigal et al.			
D698,770 S	2/2014	Park			
D702,219 S	4/2014	Suk			
D702,230 S	4/2014	Toh et al.	CN	301867415 S	3/2012
D705,188 S	5/2014	Chau et al.	CN	302242618 S	12/2012
D706,235 S	6/2014	Kim	CN	302268386 S	1/2013
D706,251 S	6/2014	Park	CN	302279529 S	1/2013
D706,301 S	6/2014	Akana et al.	CN	302321988 S	2/2013
D707,223 S	6/2014	Akana et al.	CN	302333118 S	2/2013
			CN	302350915 S	3/2013

FOREIGN PATENT DOCUMENTS

CN	302404040	S	4/2013
CN	302430473	S	5/2013
CN	202998218	U	6/2013
CN	302455942	S	6/2013
CN	302476338	S	6/2013
CN	302560014	S	9/2013
CN	302588771	S	9/2013
CN	302606411	S	10/2013
CN	302808732	S	4/2014
CN	302873818	S	7/2014
CN	302982246	S	10/2014
CN	303000183	S	11/2014
CN	303000194	S	11/2014
EM	002088591-0001		8/2012
GB	6096543		7/2020
GB	6120616	*	2/2021
HK	2117631-0002	*	4/2021
HK	2118871-0001	*	12/2021
HK	2118871-0002	*	12/2021
JP	D1326330	S	4/2008
JP	D1351277	S	2/2009
JP	D1456810	S	12/2012
JP	D1469635	S	5/2013
JP	D1478342	S	9/2013
RU	00079636		9/2011
RU	00082069		6/2012
RU	00099312		8/2016
TW	D149042	S	9/2012
TW	200656-0001	*	11/2019
TW	214713-0001	*	10/2021
TW	219206-0001	*	6/2022
TW	219207-0001	*	6/2022
WO	WO DM/080555	S	2/2013

OTHER PUBLICATIONS

Apple iPad Pro 11 inches, date first available: Jun. 18, 2019, [retrieved Dec. 15, 2022], Retrieved from Internet, URL: <<https://www.amazon.com/Apple-iPad-inches-Late-256GB/dp/B07Z6KV2SH?th=1>> (Year: 2019).*

Apple iPad Pro (2018) Review, Nov. 14, 2018, [retrieved Dec. 15, 2022], Retrieved from Internet, URL: <https://www.phonearena.com/reviews/Apple-iPad-Pro-2018-Review_id4585> (Year: 2018).*

Apple iPad Pro 2018 (11-inch) Review, Apr. 24, 2019, [retrieved Dec. 15, 2022], Retrieved from Internet, URL: <<https://www.lifewire.com/apple-ipad-pro-2018-11-inch-review-4590128>> (Year: 2019).*

iPad Pro 11in (2018) review, Sep. 24, 2020, [retrieved Dec. 15, 2022], Retrieved from Internet, URL: <<https://www.techadvisor.com/article/719682/ipad-pro-11in-2018-review-2.html>> (Year: 2020).*

Apple iPad Pro 12.9-inch, date first available: Mar. 29, 2019, [retrieved Jan. 12, 2022], Retrieved from Internet, URL: <<https://www.amazon.com/Apple-iPad-12-9-inch-Wi-Fi-Generation/dp/B07Q4F7Q9C?th=1>> (Year: 2019).

Apple iPad Pro (2018), Oct. 30, 2018, [retrieved Jan. 12, 2022], Retrieved from Internet, URL: <<https://www.engadget.com/2018-10-30-apple-ipad-pro-2018-hands-on-preview-bigger-better.html?guccounter=1>> (Year: 2018).

Apple iPad Pro 2018 (11-inch) Review, Apr. 24, 2019, [retrieved Jan. 12, 2022], Retrieved from Internet, URL: <<https://www.lifewire.com/apple-ipad-pro-2018-11-inch-review-4590128>> (Year: 2019).

“Apple iPad Pro Review 2018: The Fastest iPad is Still an iPad, Nov. 5, 2018, [retrieved Jan. 12, 2022], Retrieved from Internet, URL: <<https://www.theverge.com/2018/11/5/18062612/apple-ipad-pro-review-2018-screen-usb-c-pencil-price-features>> (Year: 2018).”

New iPad Pro 2018 review, Nov. 30, 2018, [retrieved Jan. 12, 2022], Retrieved from Internet, URL: <<https://www.express.co.uk/life-style/science-technology/1041000/iPad-Pro-2018-review-UK-release-price>> (Year: 2018).

Should you buy the iPad Air or the 11-inch iPad Pro?, Jul. 28, 2021, [retrieved Jan. 12, 2022], Retrieved from Internet, URL: <<https://9to5mac.com/2021/07/28/should-you-buy-ipad-air-or-ipad-pro/>> (Year: 2021).

Engadget, “Meizu’s M8? Apple lawyers, start your engines”, accessed at <http://www.engadget.com/2007/01/29/meizus-m8-apple-lawyers-start-your-engines/>, accessed on Jan. 29, 2007, 3 pages.

Photo-John, “Apple’s iPhone 5 Camera—What’s New?”, as archived at <https://web.archive.org/web/20140805181048/http://www.photographyreview.com/reviews/apple-iphone-5-camera-whats-new>, published Sep. 12, 2012, 3 pages.

MacManus, Christopher, cnet.com, “Artist pictures a budget iPhone—in color.” accessed at <http://www.cnet.com/au/news/artist-pictures-a-budget-iphone-in-color/>, accessed at Mar. 21, 2013, 4 pages.

stuff.tv, “Spare wallets rejoice, the plastic budget iPhone 5S cometh, The iPhone 5S may not be an incremental increase but a decrease, in price and build quality.” accessed at <http://www.stuff.tv/apple/sparse-wallets-rejoice-plastic-budget-iphone-5s-cometh/news>, accessed on Mar. 23, 2013, 1 page.

Mayo, B., “Purported iPhone 6 Pictures Show Protruding Camera, Rounded Edges,” 9to5Mac.com, accessed at <http://9to5mac.com/2014/03/31/purported-iphone-6-pictures-show-protruding-camera-rounded-edges/>, 23 pages.

Carlson, Ronald, Tapscape.com, “Translucent iPhone: Will Apple Revisit G3 iMac?,” accessed at <http://www.tapscape.com/translucent-iphone/>, accessed on Apr. 3, 2013, 3 pages.

Daily Life News, “iPhone 5s Leaked Images Hint 2 Different Screen Sizes.” accessed at <https://www.youtube.com/watch?v=8tcTHa63WHI>, accessed on Apr. 10, 2013, 4 pages.

Stuff Staff in News, stuffmideast.com “Apple’s new iPhone to come in a five colours.” accessed at <http://stuffmideast.com/2013/04/11/151344/apples-new-iphone-to-come-in-a-five-colours/>, accessed on Apr. 11, 2013, 1 page.

Cultofandroid, “This Android-Powered iPhone 5C Clone Will Cost Just \$100 In China” accessed at http://www.cultofandroid.com/40408/this-android-powered-iphone-5c-clone-will-cost-just-100-in-china/?utm_campaign=twitter&utm_medium=twitter&utm_source=twitter, accessed on Aug. 27, 2013, 2 pages.

Gsmarena, “Nokia Lumia 820”, accessed at http://www.gsmarena.com/nokia_lumia_820-4968.php, accessed on Aug. 29, 2013, 1 page.

Gsmarena, “Xiaomi MI-2”, accessed at http://www.gsmarena.com/xiaomi_mi_2-4928.php0, accessed on Aug. 29, 2013, 1 page.

Gsmarena, “Xiaomi MI-2s”, accessed at http://www.gsmarena.com/xiaomi_mi_2s-5397.php, accessed on Aug. 29, 2013, 1 page.

Nokia, “Nokia Lumia 820—Our most versatile Lumia”, accessed at <http://www.nokia.com/global/products/phone/lumia820/>, accessed on Aug. 29, 2013, 3 pages.

welectronics.com, “Xiaomi MI 2 GSM unlocked,” accessed at <http://www.welectronics.com/gsm/misc/XIAOMI-MI-2.HTML?gclid=CK7Nr9bv-rYCFY0o4AodZ0EAEW>, accessed at Aug. 29, 2013, 1 page.

Swift, “BBK Vivo Xplay X510W Review,” published Oct. 21, 2013 accessed at <http://chinesetech.net/2013/10/21/bbk-vivo-xplay-x510w-review/>, 12 pages.

“iPhone 6, Une Énième Maquette Comparée Avec L’iPhone 5s,” published May 3, 2014, accessed at <http://www.nowhereelse.fr/iphone-6-maquette-comparee-iphone-5s-97315/>, 2 pages.

@NowhereElseFr, “Just Another Purported #iPhone6 or #iPhoneAir Dummy . . . #Apple,” published May 4, 2014, accessed at <https://twitter.com/NowhereElseFr/status/462938116924264448/photo/1>, 5 pages.

Gokey, M., “LG G3 vs. HTC One M8: Which Android Flag Should iPhone Haters Fly?,” published Sep. 18, 2014, accessed at www.digitaltrends.com/mobile/lg-g3-vs-htc-one-m8/, 12 pages.

iPhone 6 Plus, Gold, 16GB (Unlocked), posted Nov. 2, 2014, [retrieved Aug. 5, 2017]. Retrieved from Internet, <URL: https://www.amazon.com/iPhone-Plus-Gold-16GB-Unlocked/dp/B00OB5TCN6/ref=cm_cr_ar_p_d_product_top?ie=UTF8>.

Apple iPhone 7: Dual-Lens Camera Leak Suggests 3D Scanning Capabilities, posted Mar. 16, 2016, [retrieved Aug. 5, 2017]. Retrieved from Internet, <URL: <http://www.newsweek.com/apple-iphone-7-dual-lens-camera-leak-suggests-3d-scanning-capabilities-437322>>.

iPhone 7 Realistic 3D Video Rendering Based on Latest Leaks Pops Up (Video), posted Mar. 20, 2016, [retrieved Aug. 5, 2017]. Retrieved from Internet, <URL: <https://www.concept-phones.com/apple/iphone-7-realistic-3d-video-rendering-based-latest-leaks-pops-video/>>.

First Details on iPhone 7 Design: Flush Rear Camera, No Antenna Bands Across the Back, posted Feb. 2, 2016, [retrieved Nov. 29,

2017]. Retrieved from Internet, <URL: <https://www.macrumors.com/2016/02/02/iphone-7-flush-camera-no-bands/>>.

iPhone 7 Leak Reveals Significant Design Changes (Video), posted Feb. 3, 2016, [retrieved Nov. 29, 2017]. Retrieved from Internet, <URL: <https://www.youtube.com/watch?v=9oRsTRfkGIs>>.

New iPhone 7—Final Leaks & Rumors (Video), posted Feb. 7, 2016, [retrieved Nov. 29, 2017]. Retrieved from Internet, <URL: https://www.youtube.com/watch?v=_CuyHrhWGto>.

iPhone X Case, ESR 9H Tempered Glass Back Cover, posted Aug. 14, 2017, [retrieved May 9, 2018]. Retrieved from Internet, <URL: https://www.amazon.com/ESR-Tempered-Scratch-Resistant-Silicone-Absorption/dp/B079HP8T8V/ref=crn_cr_ar_p_d_product_top?ie=UTF8>.

LG's G5 Shows Bold Mobile Move, We Go Hands-On, posted Feb. 21, 2016, [retrieved May 9, 2018]. Retrieved from Internet, <URL: <https://www.tomshardware.com/reviews/lg-g5-android-smartphone-hands-on,4474.html#p1>>.

Wileyfox Swift and Storm review: Two cheap UK phones, one worth buying, posted Nov. 30, 2015, [retrieved May 9, 2018]. Retrieved from Internet, <URL: <https://www.engadget.com/2015/11/30/wileyfox-swift-storm-review/>>.

Gionee S10 is an iPhone 7 Plus look-alike but with 4 cameras, 6GB RAM and half the price, S10B and S10C also unveiled., posted May 30, 2017, [retrieved May 9, 2018]. Retrieved from Internet, <URL: <https://technoran.com/%E2%80%8Bgionee-s10-is-an-iphone-7-plus-look-alike-but-with-4-carneras-Ggb-rarn-and-half-the-price-s1>>.

Hands-On With an iPhone 8 Dummy Model, posted Aug. 10, 2017, [retrieved Aug. 28, 2017]. Retrieved from Internet, <URL: <https://www.youtube.com/watch?v=YuQUBhOAbUM>>.

Apple iPhone 7 is here with a water resistant body, better cameras, 256GB capacity & no headphone jack, posted Sep. 8, 2016, [retrieved Aug. 28, 2017]. Retrieved from Internet, <URL: <https://collinsdail.blogspot.com/2016/09/apple-iphone-7-is-here-with-water.html>>.

Apple Iphone 7 and 7plus New Camera, posted Sep. 8, 2016, [retrieved Aug. 28, 2017]. Retrieved from Internet, <URL: <http://sujoyrdas.blogspot.com/2016/09/apple-iphone-7-and-7plus-new-camera.html>>.

Sparks, David, "iPad Sans Bezel" McSparky Blog, Nov. 10, 2017. Available at <<https://www.macsparky.com/blog/2017/11/ipad-sans-bezel>>.

iPhoneheat, "Apple to Launch New iPad Pro with Face ID in June?" JailBreakGuides.com, Mar. 7, 2018. Available at <<https://www.jailbreakguides.com/2018/03/07/apple-to-launch-new-ipad-pro-with-face-id-in-june/>>.

Parrish, Kevin, "Apple Registers 10 Unannounced MacBook and iPad Devices Overseas" DigitalTrends.com, Jul. 5, 2018. Available at <<https://www.digitaltrends.com/computing/apple-registered-ten-macbooks-ipads-overseas/>>.

EverythingApplePro, "2018 iPad Pro X Is Happening! New Leaks & Concepts" Youtube.com, Jun. 30, 2018. Available at <<https://www.youtube.com/watch?v=VOPXgDCwyq8&feature=youtu.be&t=19>>.

"HP Compaq Tablet PC tc 1100", downloaded Aug. 27, 2004.

"Tablet PC V1100", downloaded Aug. 27, 2004.

"ViewPad 1000", downloaded Aug. 27, 2004.

* cited by examiner

Primary Examiner — Messina L Smith

Assistant Examiner — Aram Kwon

(74) *Attorney, Agent, or Firm* — Sterne, Kessler, Goldstein & Fox P.L.L.C.

(57)

CLAIM

The ornamental design for an electronic device, as shown and described.

DESCRIPTION

FIG. 1 is a bottom front perspective view of a first embodiment of an electronic device showing the claimed design;

FIG. 2 is a top rear perspective view thereof;

FIG. 3 is a front view thereof;

FIG. 4 is a rear view thereof;

FIG. 5 is a left side view thereof;

FIG. 6 is a right side view thereof;

FIG. 7 is a top view thereof;

FIG. 8 is a bottom view thereof;

FIG. 9 is a bottom front perspective view of a second embodiment of an electronic device showing the claimed design;

FIG. 10 is a top rear perspective view thereof;

FIG. 11 is a front view thereof;

FIG. 12 is a rear view thereof;

FIG. 13 is a left side view thereof;

FIG. 14 is a right side view thereof;

FIG. 15 is a top view thereof; and,

FIG. 16 is a bottom view thereof.

The broken lines in the figures show portions of the electronic device that form no part of the claimed design.

1 Claim, 12 Drawing Sheets

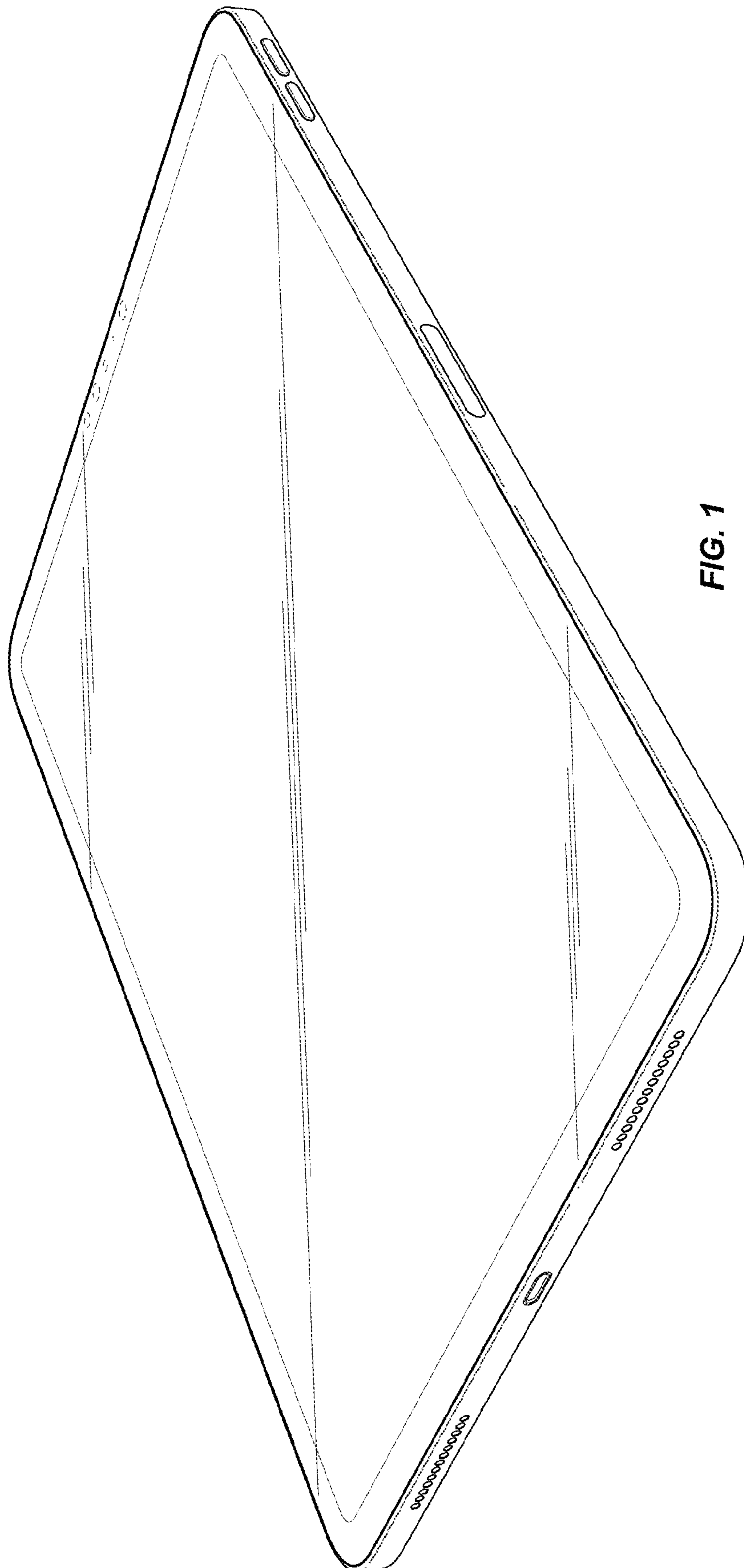

FIG. 1

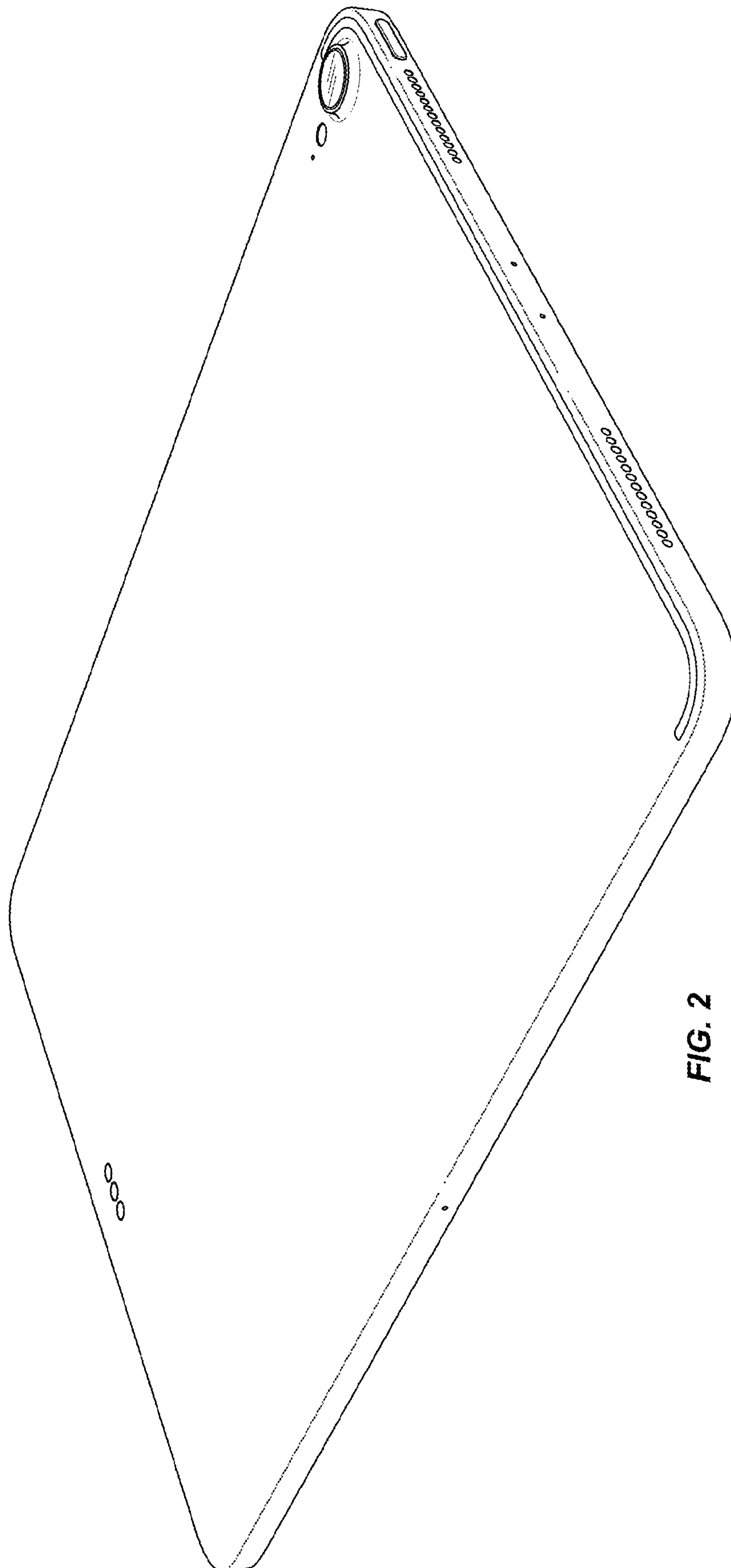

FIG. 2

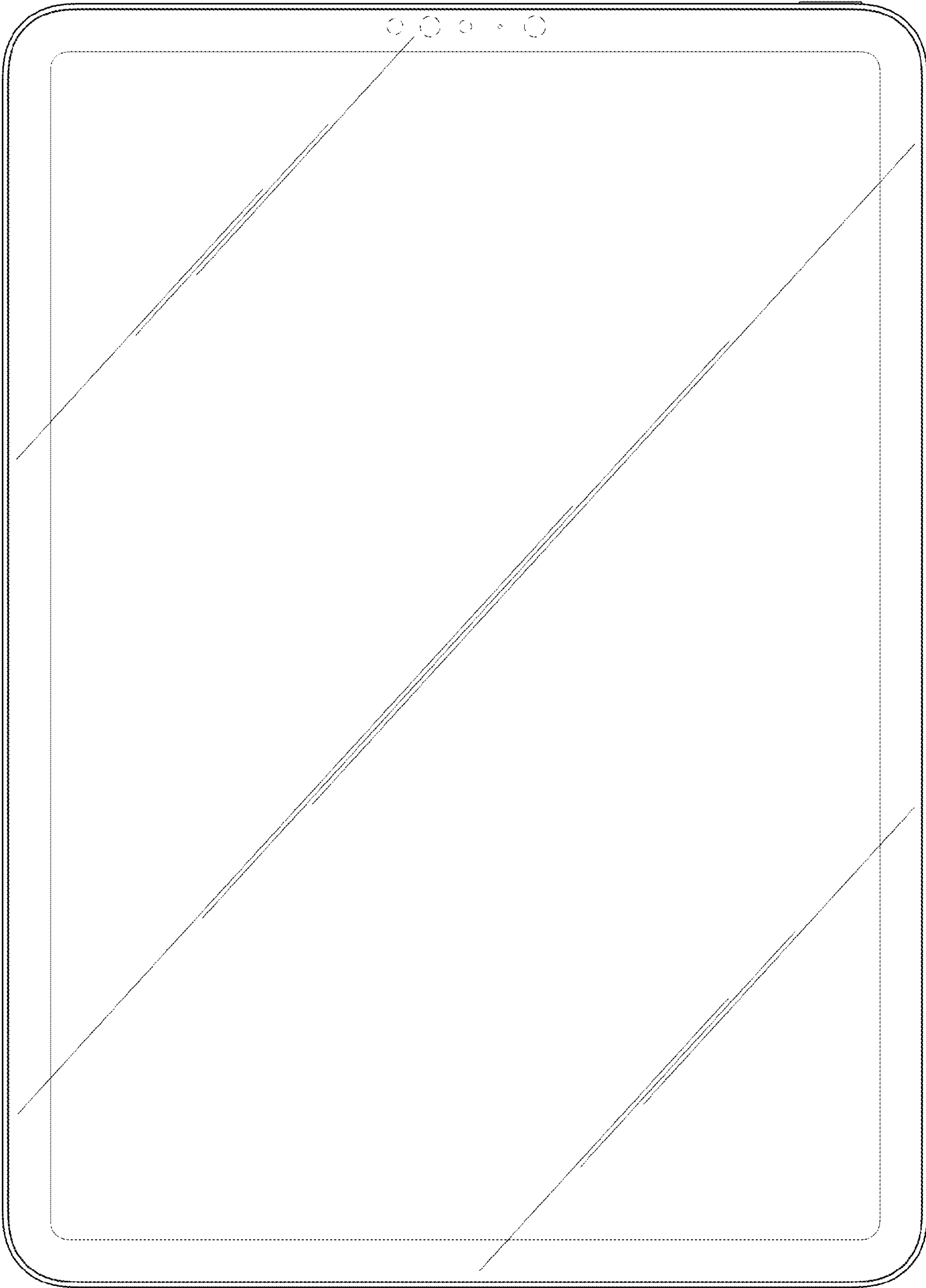

FIG. 3

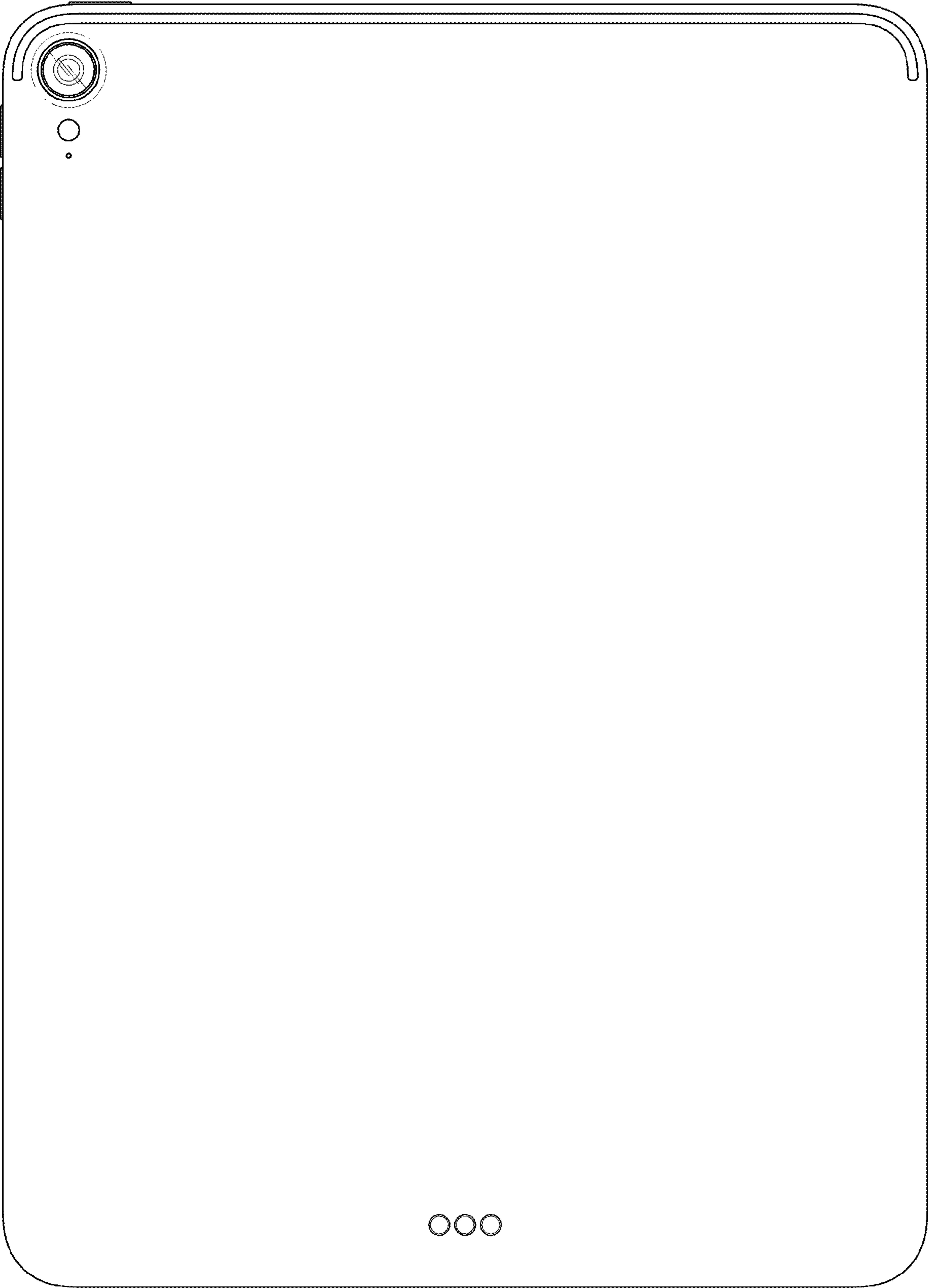

FIG. 4

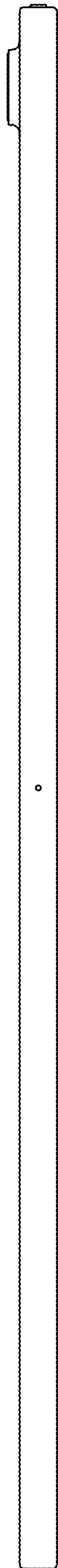

FIG. 5



FIG. 6

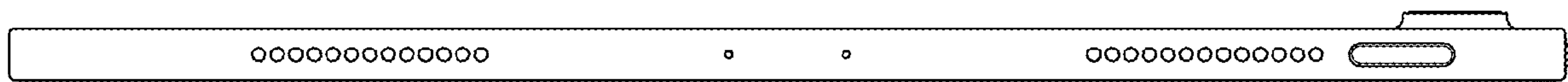

FIG. 7

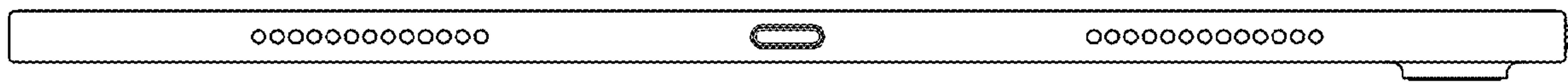

FIG. 8

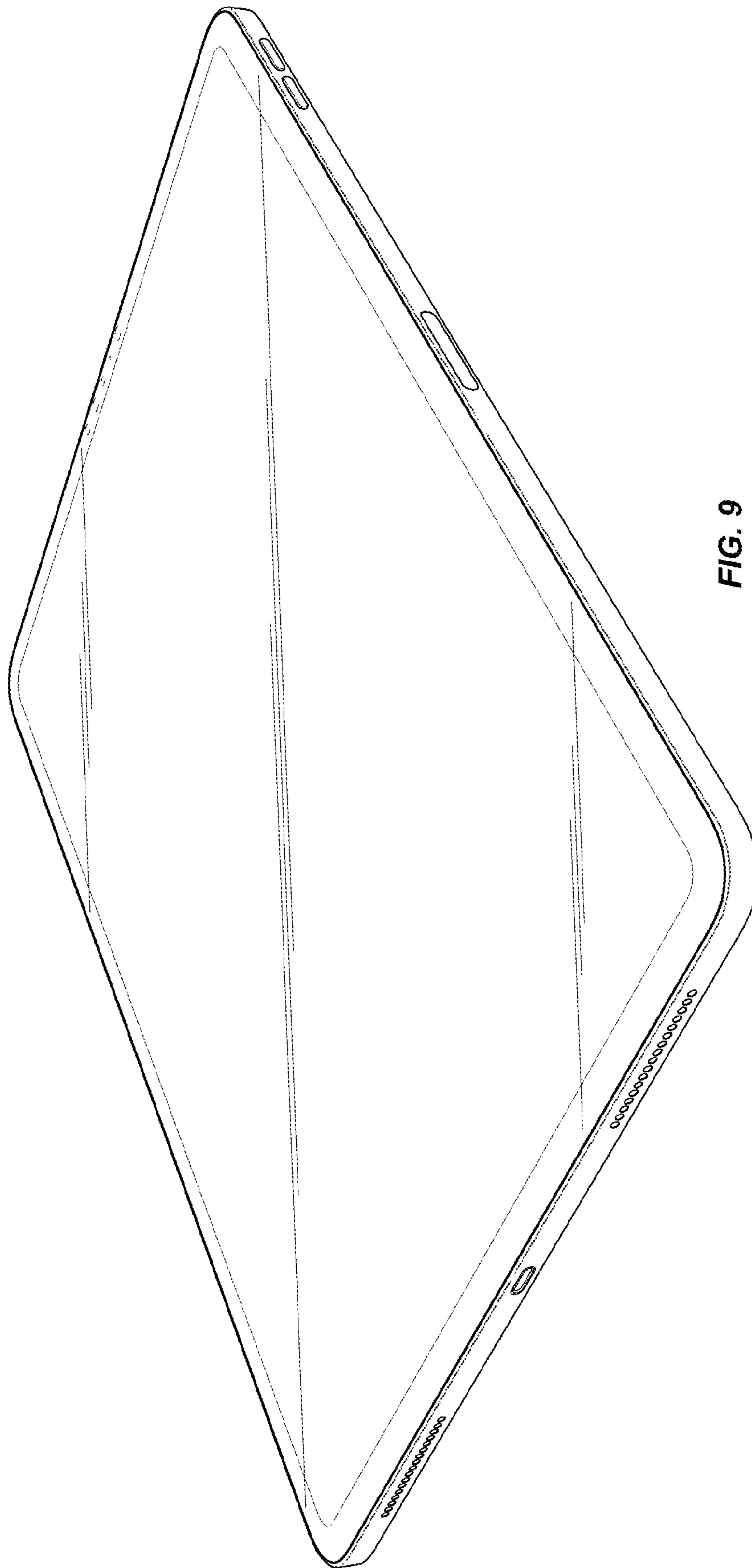

FIG. 9

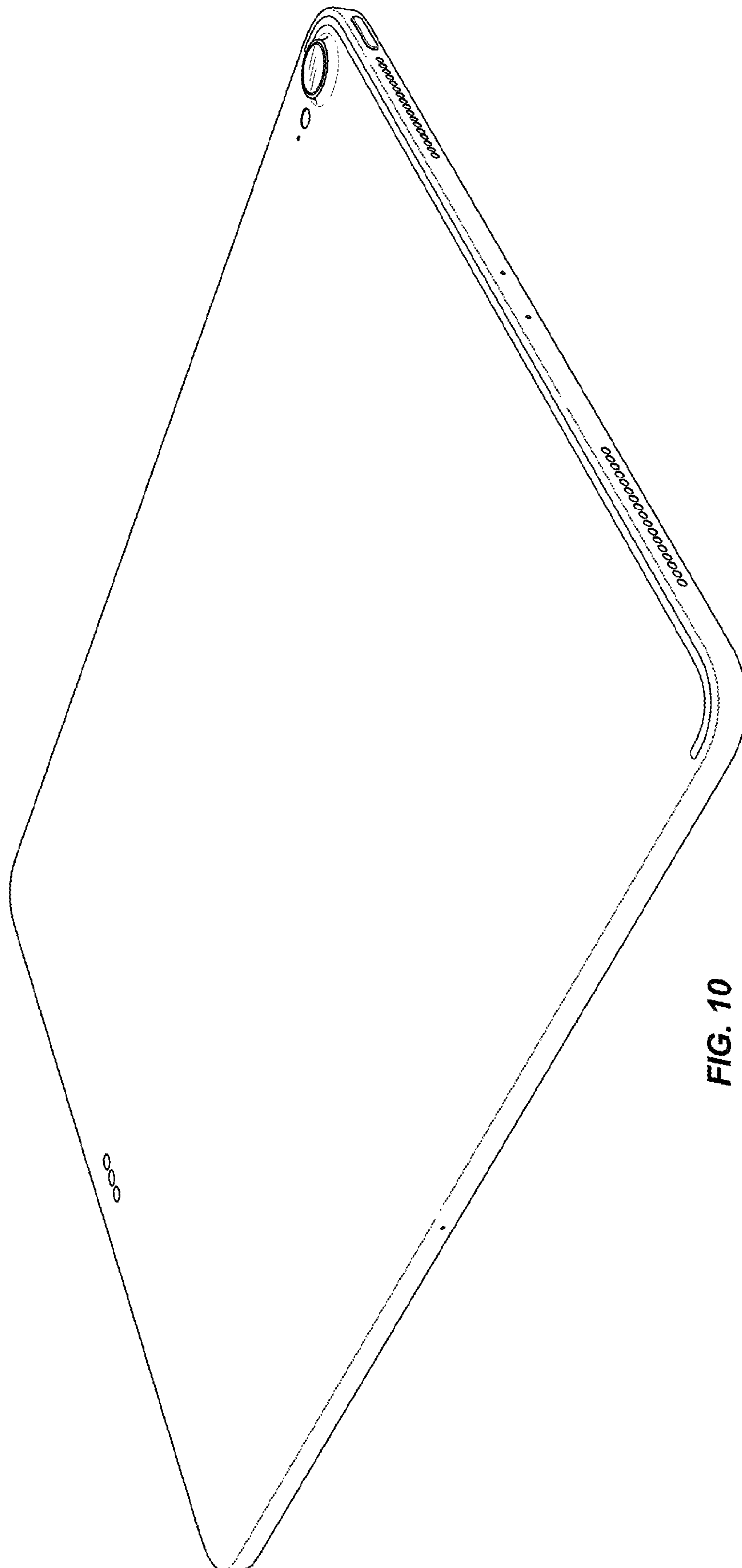

FIG. 10

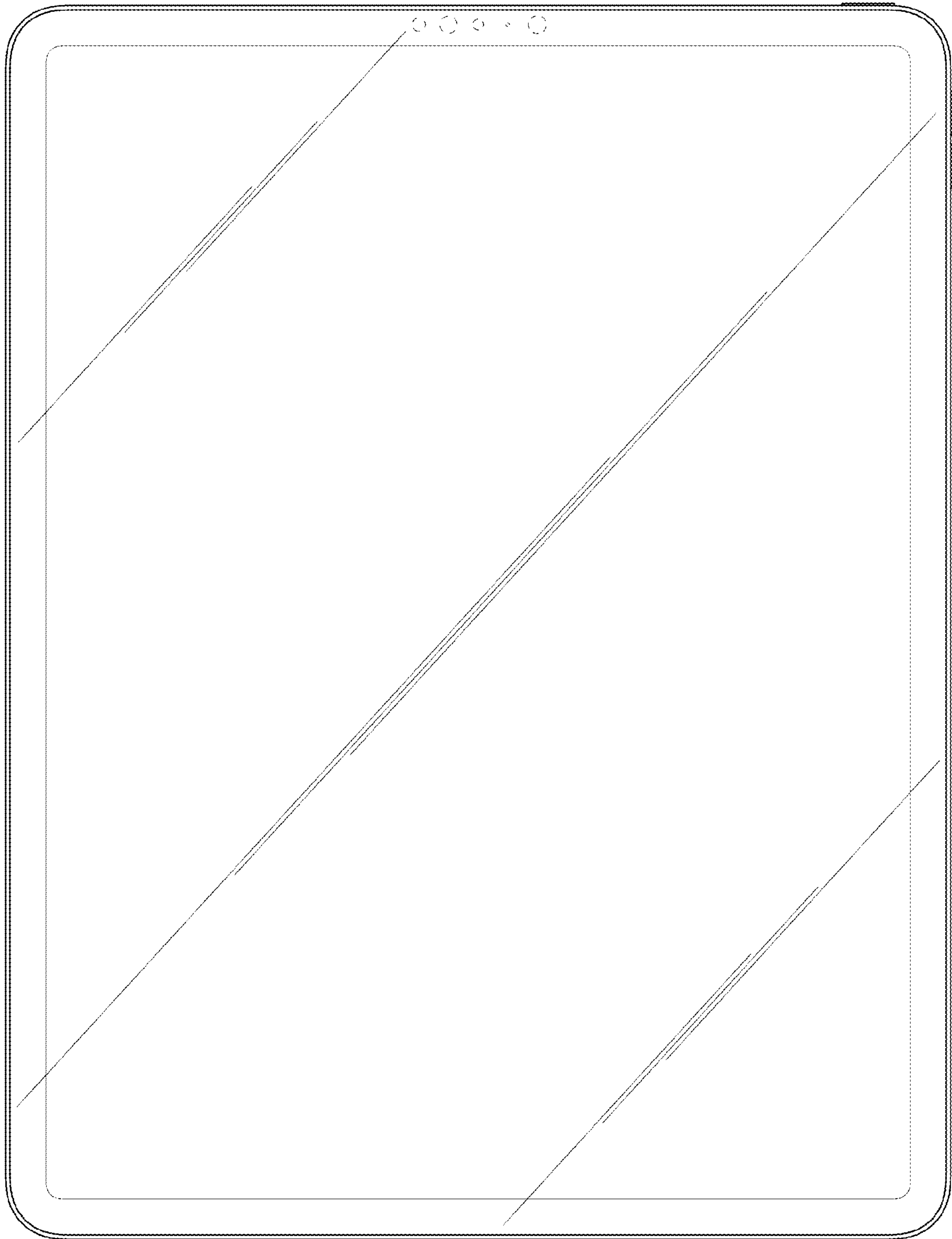

FIG. 11

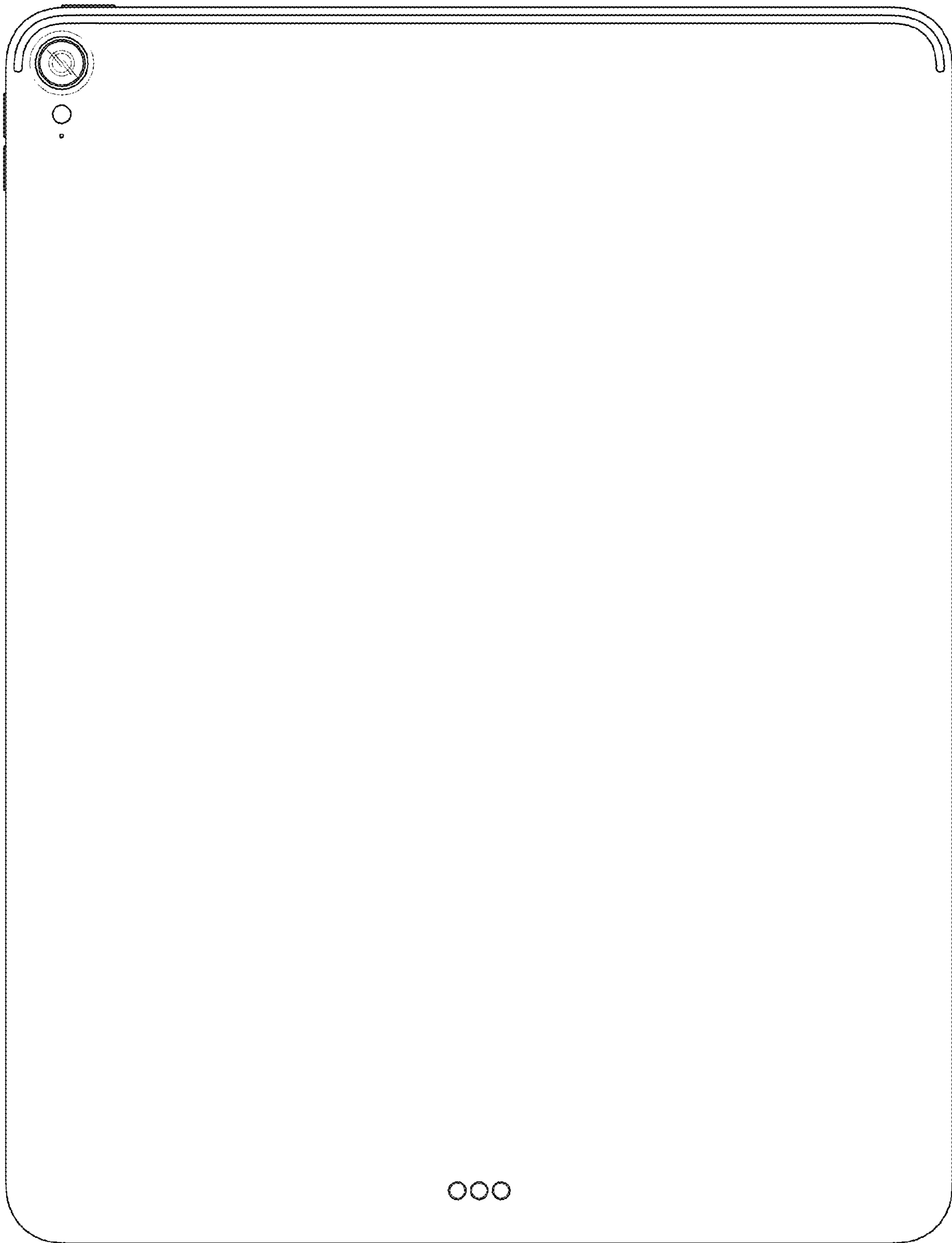

FIG. 12

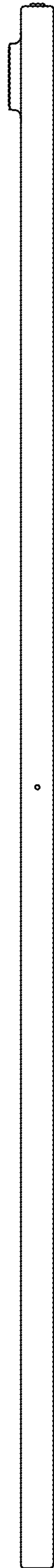

FIG. 13

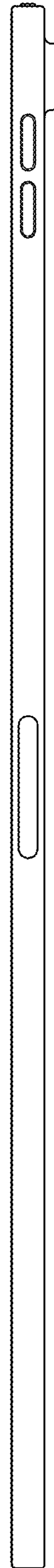

FIG. 14

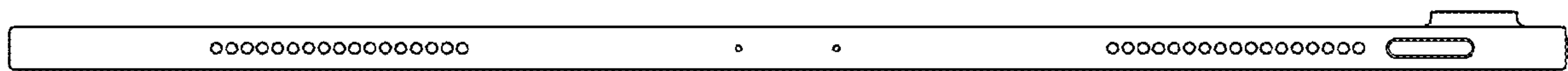

FIG. 15

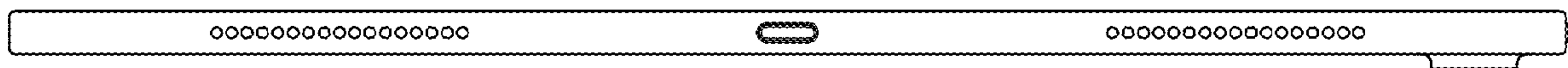

FIG. 16