



US00D985489S

(12) **United States Design Patent**
Chen

(10) **Patent No.:** **US D985,489 S**

(45) **Date of Patent:** **** May 9, 2023**

(54) **PORTABLE POWER STATION**

(71) Applicant: **Shenzhen Montek New Energy Co., Limited**, Guangdong (CN)

(72) Inventor: **Kaizu Chen**, Guangdong (CN)

(73) Assignee: **Shenzhen Montek New Energy Co., Limited**, Shenzhen (CN)

(**) Term: **15 Years**

(21) Appl. No.: **29/804,104**

(22) Filed: **Aug. 18, 2021**

(30) **Foreign Application Priority Data**

Jul. 19, 2021 (CN) 202130457983.2

(51) **LOC (14) Cl.** **13-02**

(52) **U.S. Cl.**
USPC **D13/103; D13/108**

(58) **Field of Classification Search**
USPC D13/102–110, 118–119, 184, 199;
D14/356, 432

CPC Y02E 60/10; Y02E 60/50; H01M 10/44;
H01M 10/46; H01M 10/465; H01M
10/482; H01M 2200/30; H01M 2250/30;
H01M 2250/40; H02J 7/00; H02J 7/0003;
H02J 7/0013; H04M 1/0283; H04B
1/3888; A45C 2011/002

See application file for complete search history.

(56) **References Cited**

U.S. PATENT DOCUMENTS

D393,446 S * 4/1998 Bellofatto D13/106
D462,519 S * 9/2002 Gaydos D3/276

D581,867 S * 12/2008 Crawford D13/103
D664,499 S * 7/2012 Workman D13/107
D695,680 S * 12/2013 Workman D13/106
D773,992 S * 12/2016 Krantz D13/110
D776,523 S * 1/2017 Sabbag D9/425
D792,708 S * 7/2017 Tazawa D3/276
D837,147 S * 1/2019 Baxter D13/103
D872,011 S * 1/2020 Rao D13/107
D872,471 S * 1/2020 Zhao D3/276
D967,013 S * 10/2022 Underhill D13/107
2017/0197765 A1 * 7/2017 Hu B65D 25/2852

* cited by examiner

Primary Examiner — Nathaniel D. Buckner

(57) **CLAIM**

The ornamental design for a portable power station, as shown and described.

DESCRIPTION

FIG. 1 is a top, front and right side perspective view of a portable power station showing my new design;
FIG. 2 is a bottom, rear and left side perspective view thereof;
FIG. 3 is a front elevational view thereof;
FIG. 4 is a rear elevational view thereof;
FIG. 5 is a left side view thereof;
FIG. 6 is a right side view thereof;
FIG. 7 is a top plan view thereof; and,
FIG. 8 is a bottom plan view thereof.
The broken lines in the drawings illustrate portions of the portable power station which form no part of the claimed design.

1 Claim, 8 Drawing Sheets

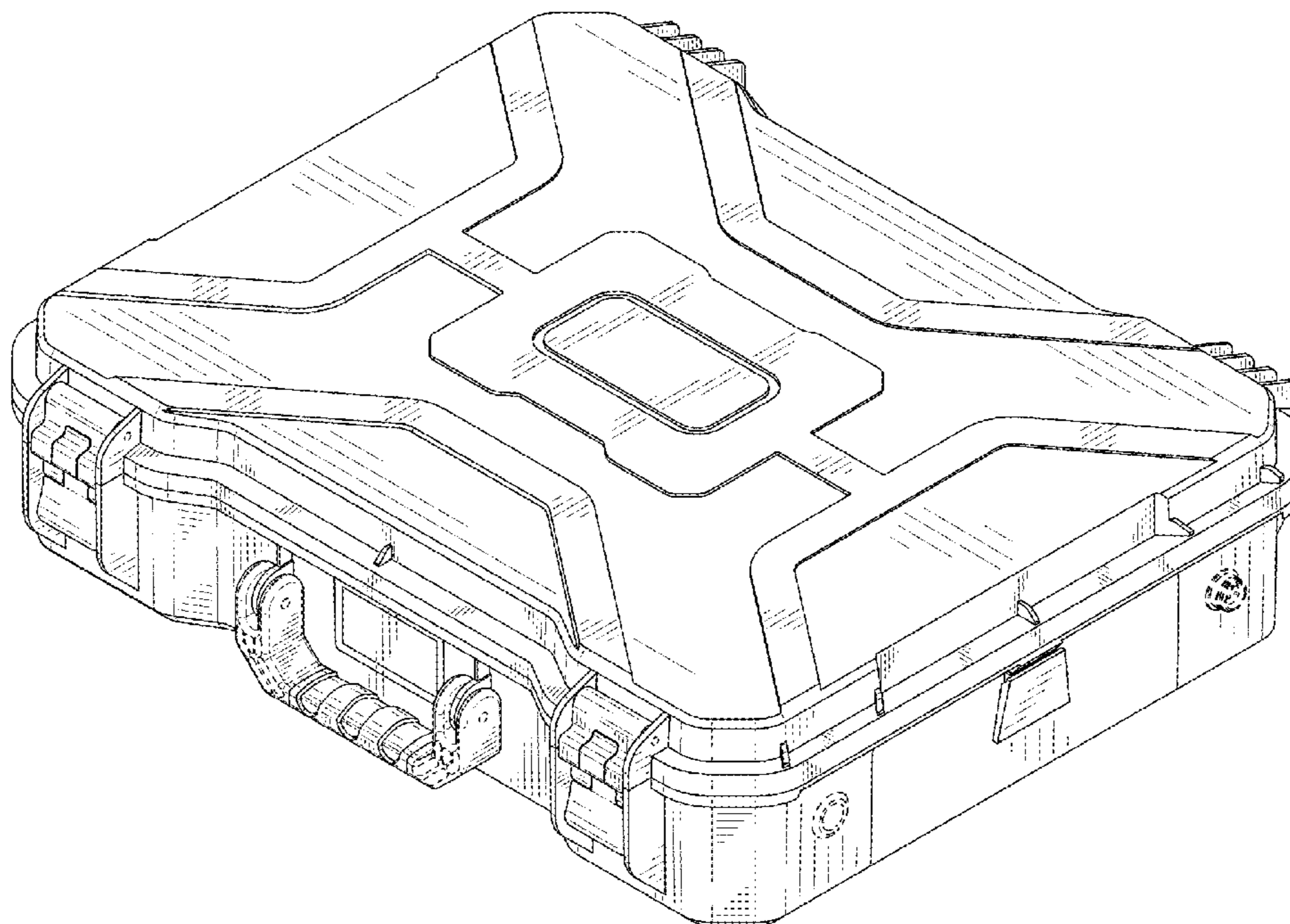

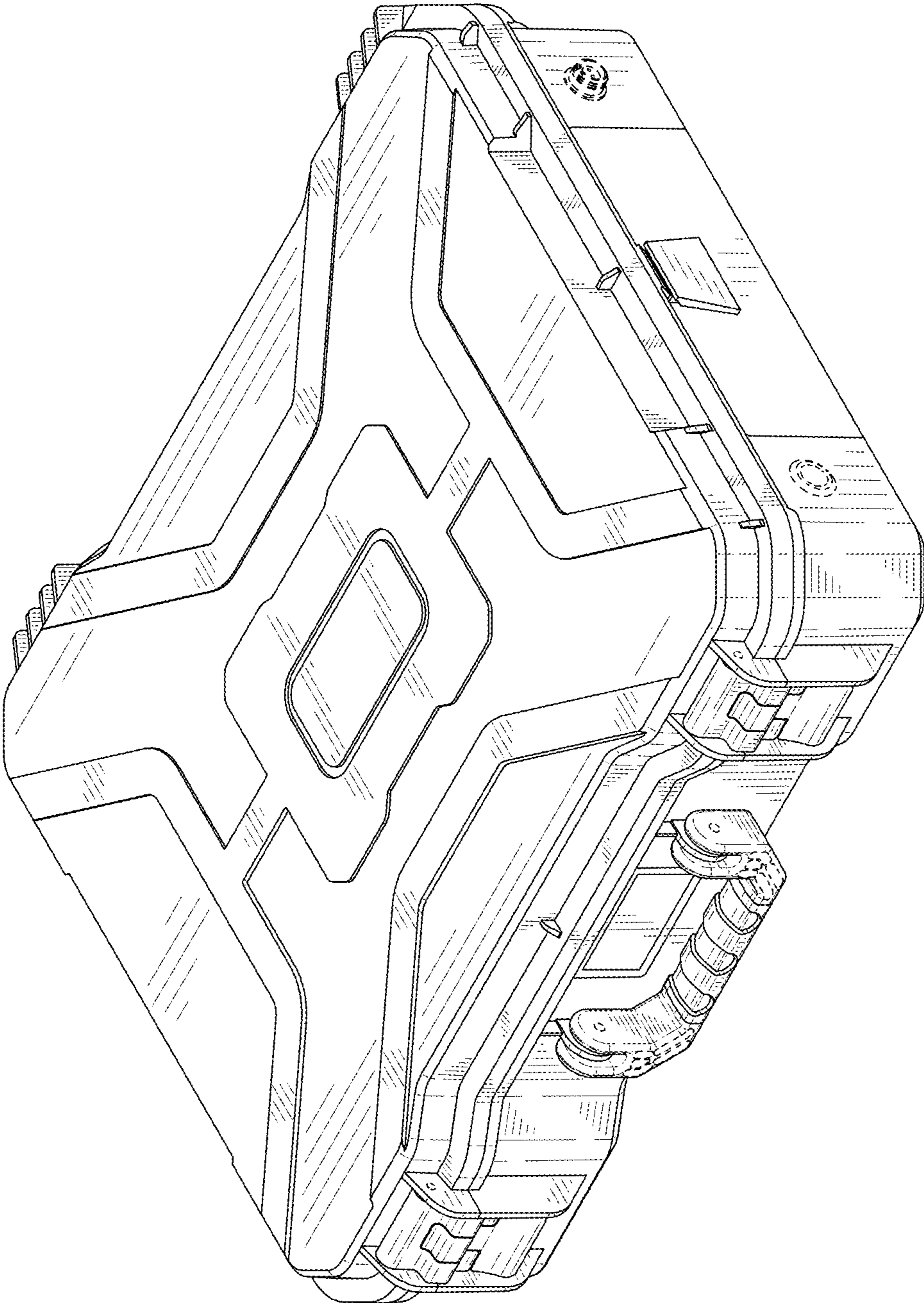

FIG. 1

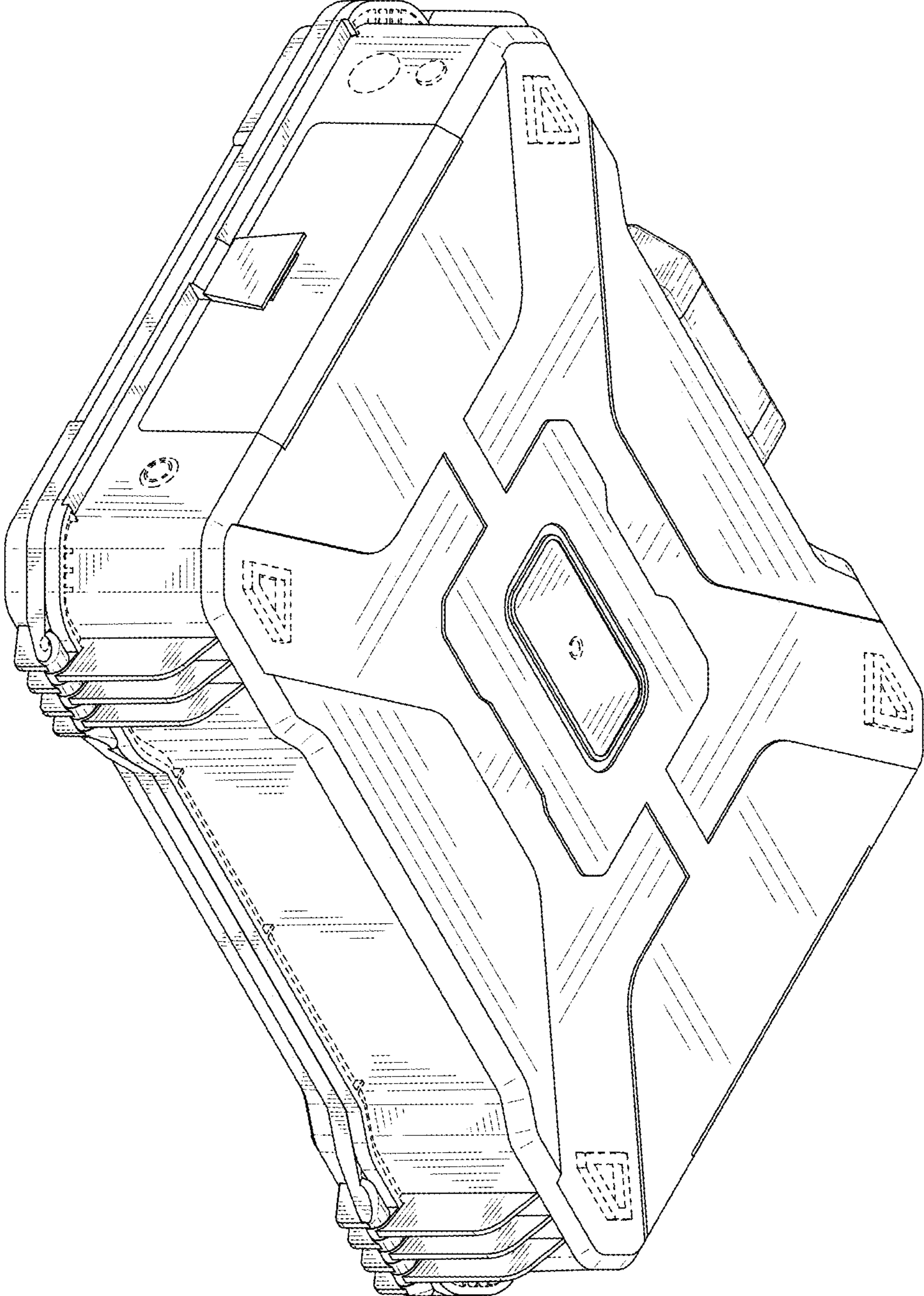

FIG. 2

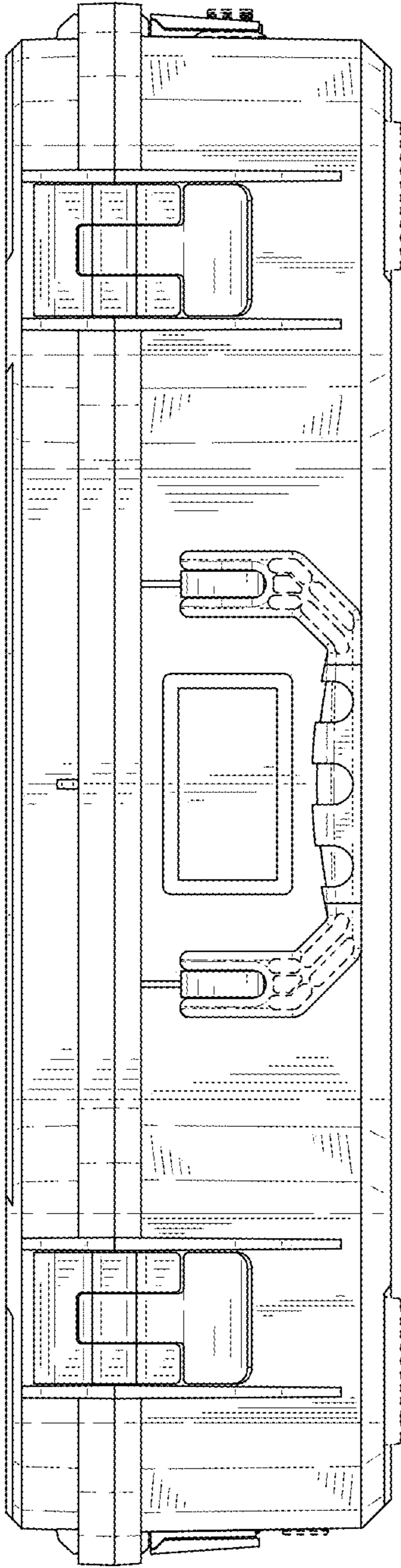

FIG. 3

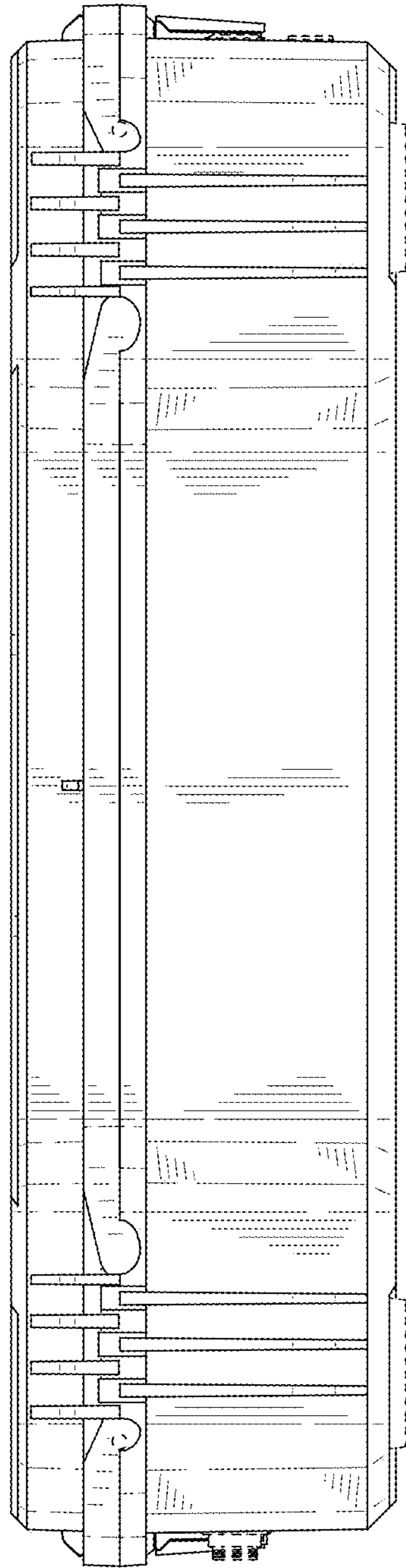

FIG. 4

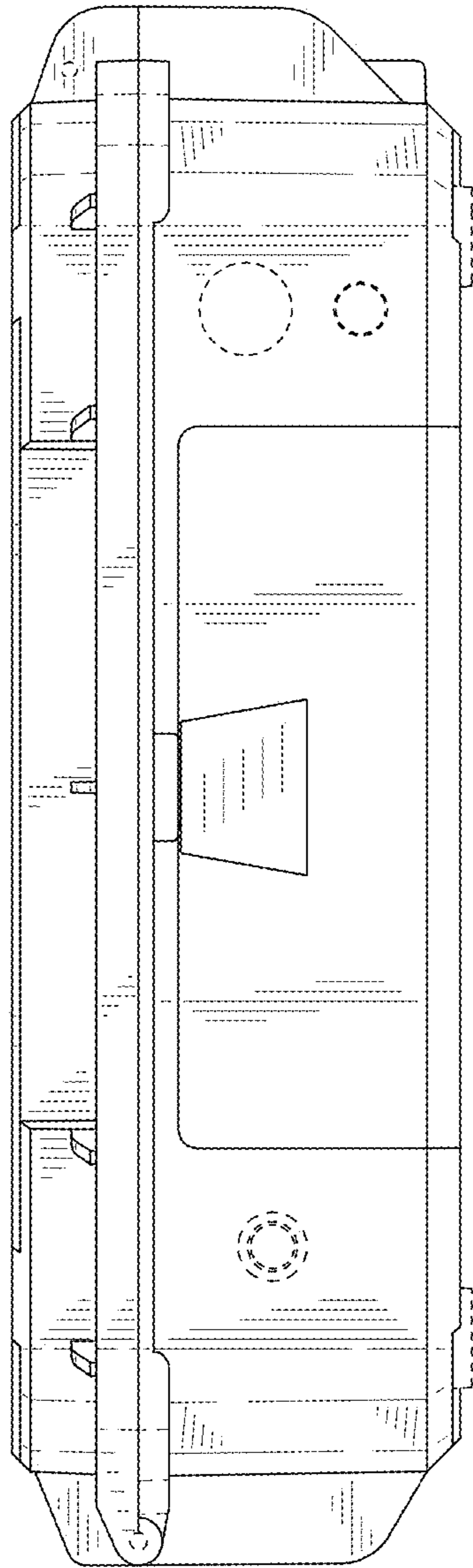

FIG. 5

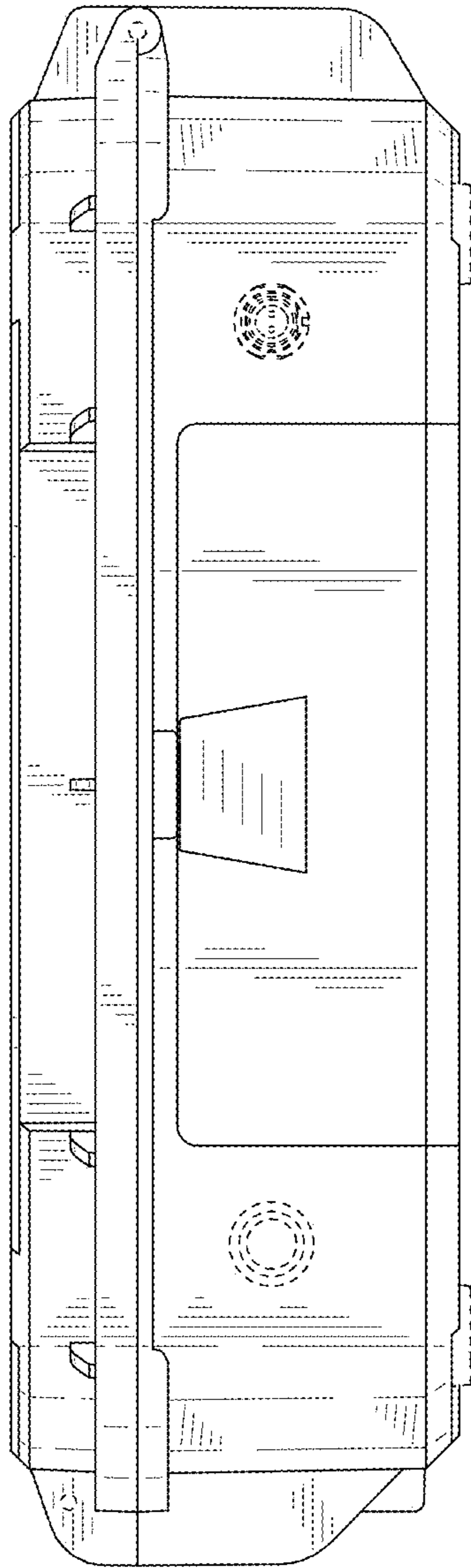

FIG. 6

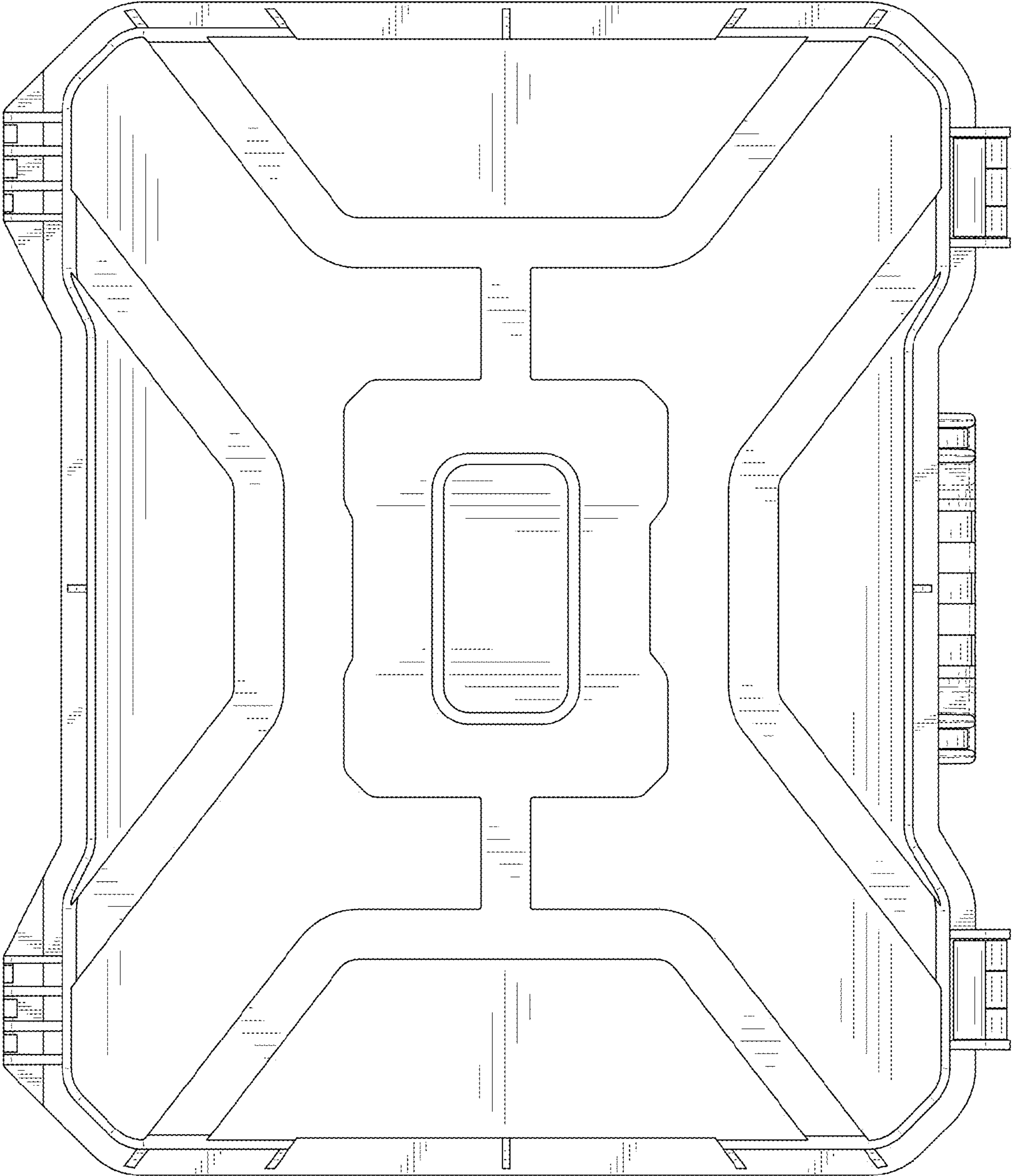

FIG. 7

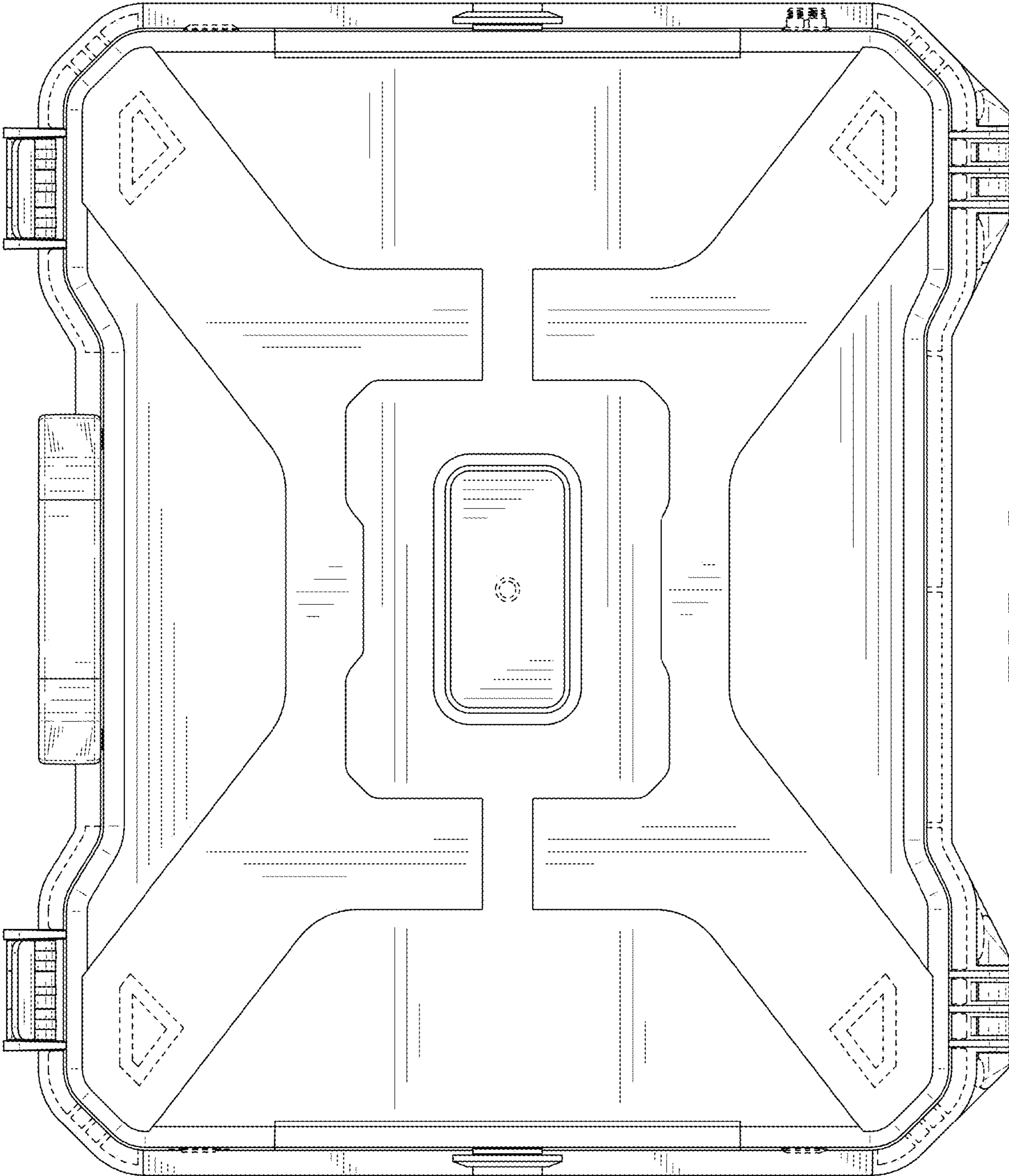

FIG. 8