



US00D985418S

(12) **United States Design Patent**  
**Zhao**

(10) **Patent No.:** **US D985,418 S**  
(45) **Date of Patent:** **\*\* May 9, 2023**

(54) **TREE STAND**

FOREIGN PATENT DOCUMENTS

(71) Applicant: **Ningbo Tree Nest International Trading Co., Ltd., Ningbo (CN)**

CN 202030261017.9 \* 10/2020  
CN 202130169655.2 \* 7/2021  
GB 9007975404-0001 \* 5/2020

(72) Inventor: **Honghua Zhao, Ningbo (CN)**

(\*\*) Term: **15 Years**

OTHER PUBLICATIONS

(21) Appl. No.: **29/736,376**

Tree Nest Tree Collar, published on (Nov. 10, 2020) on amazon.com, retrieved from internet (Oct. 28, 2022). <URL: <https://www.amazon.com/Tree-Nest-Christmas-Collar-Skirt/dp/B08FDKMB1K>> (Year: 2020).\*

(22) Filed: **May 29, 2020**

(51) **LOC (14) Cl.** ..... **06-99**

\* cited by examiner

(52) **U.S. Cl.**

USPC ..... **D11/130.1; D11/130**

(58) **Field of Classification Search**

USPC ..... D11/117, 130, 130.1, 131, 143-145, D11/152-154

CPC ..... A47G 33/12; A47G 2033/1286

See application file for complete search history.

*Primary Examiner* — Joseph Kukella

*Assistant Examiner* — Heather Ann Laaveg Wencil

(74) *Attorney, Agent, or Firm* — Rumit Ranjit Kanakia

(56) **References Cited**

(57) **CLAIM**

U.S. PATENT DOCUMENTS

The ornamental design for a tree stand, as shown and described.

- D166,740 S \* 5/1952 Dodge ..... D11/131
- D190,740 S \* 6/1961 Pistey ..... A47G 33/12
- D283,929 S \* 5/1986 Manton ..... D11/131
- D285,849 S \* 9/1986 Hughes ..... D26/110
- D318,441 S \* 7/1991 Morritt ..... D34/1
- D342,447 S \* 12/1993 Aylward ..... D11/155
- 5,782,453 A \* 7/1998 Tuzza ..... D9/429
- 248/519
- D444,933 S \* 7/2001 Parker ..... A47G 33/12
- D511,458 S \* 11/2005 Dunwoody ..... D9/519
- D561,021 S \* 2/2008 DuVal ..... D99/24
- D752,972 S \* 4/2016 Goldstein ..... D9/500
- D760,115 S \* 6/2016 Zhao ..... D9/500
- D760,116 S \* 6/2016 Zhao ..... D9/429
- D11/130
- D11/130

**DESCRIPTION**

FIG. 1 is a front elevational view of a tree stand showing my new design;  
FIG. 2 is a rear elevational view thereof;  
FIG. 3 is a left sideview thereof;  
FIG. 4 is a right sideview thereof;  
FIG. 5 is a top planview thereof;  
FIG. 6 is a bottom plan view thereof; and,  
FIG. 7 is a perspective view thereof.

**1 Claim, 7 Drawing Sheets**

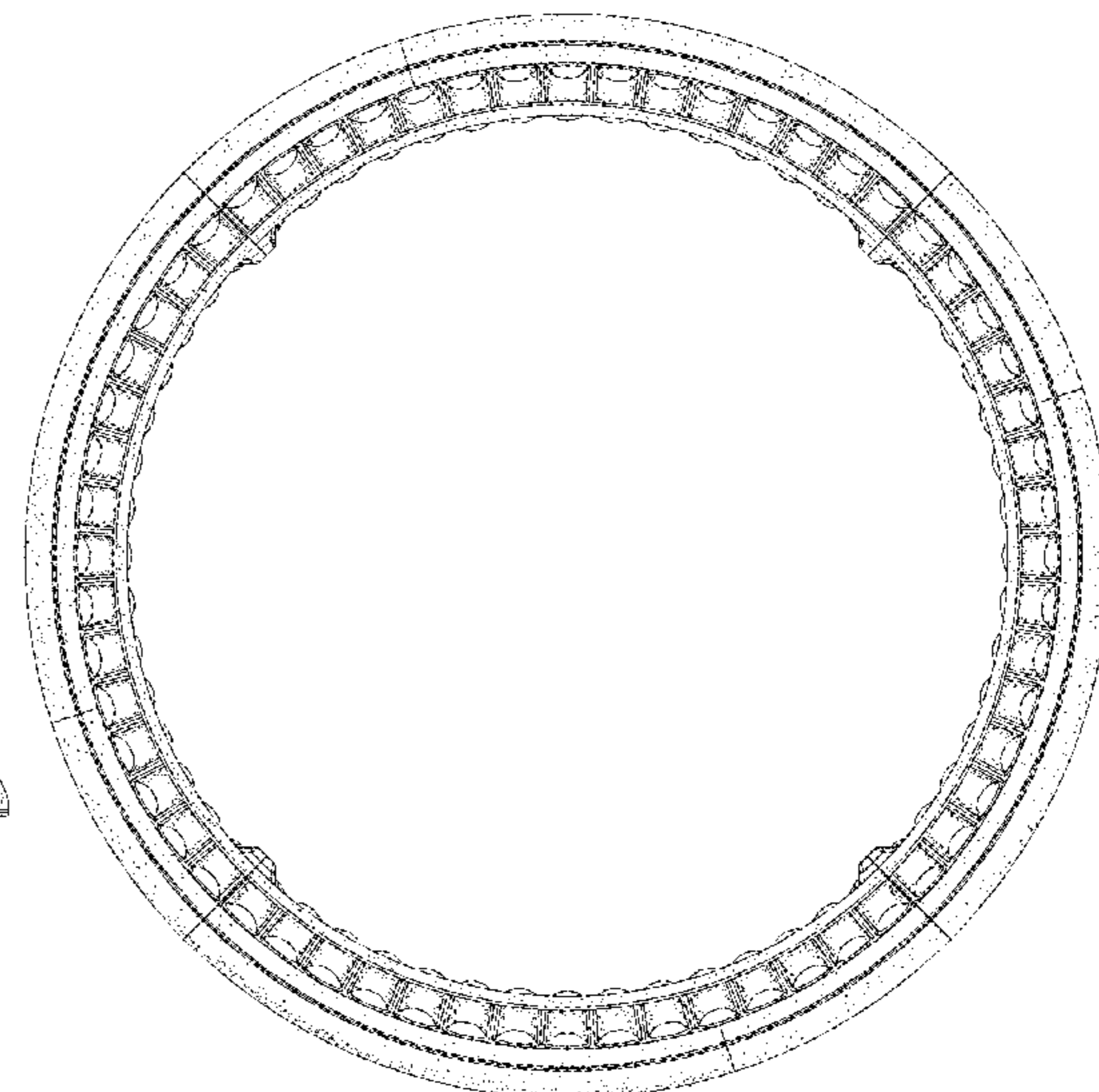
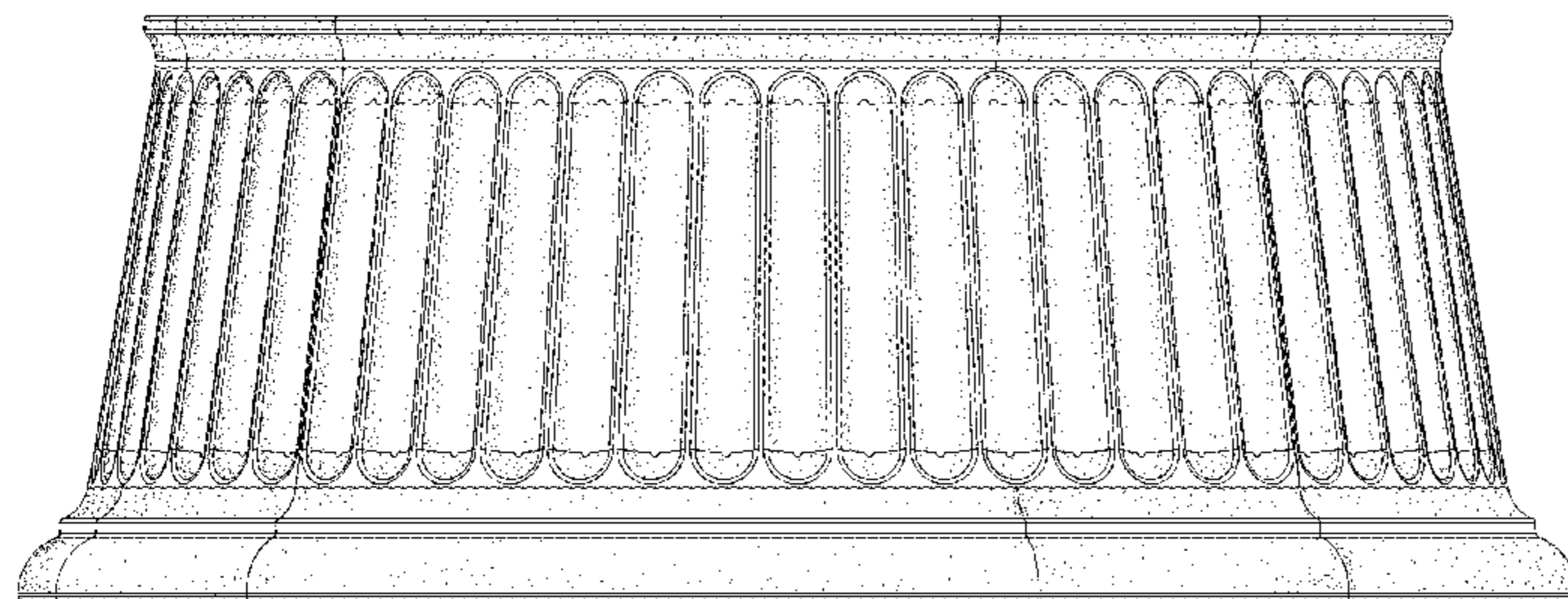

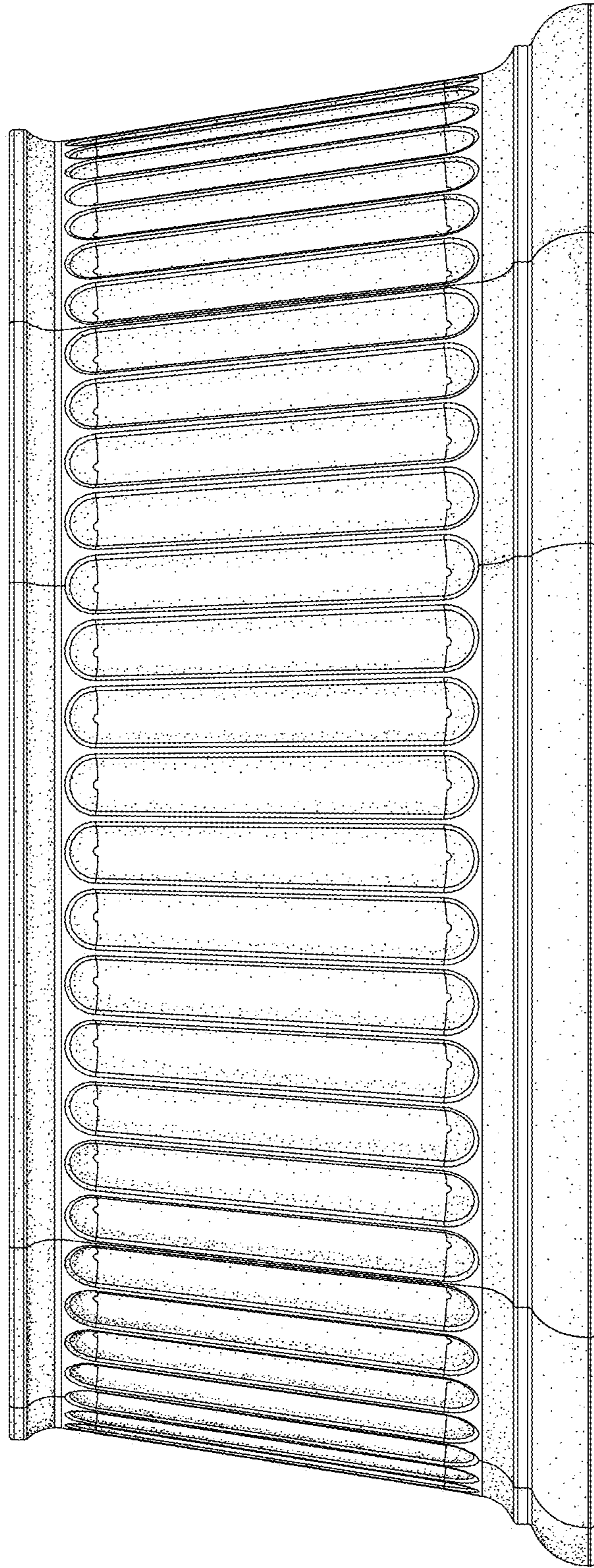

Fig. 1

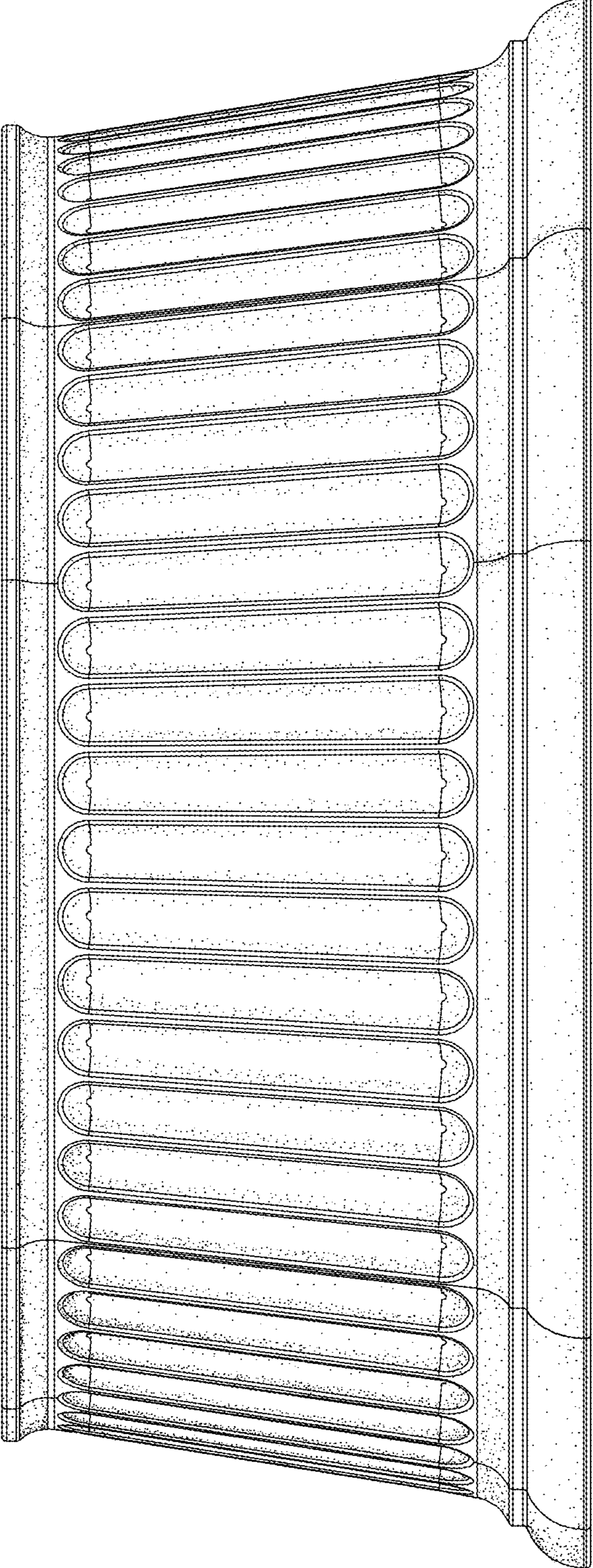

Fig. 2

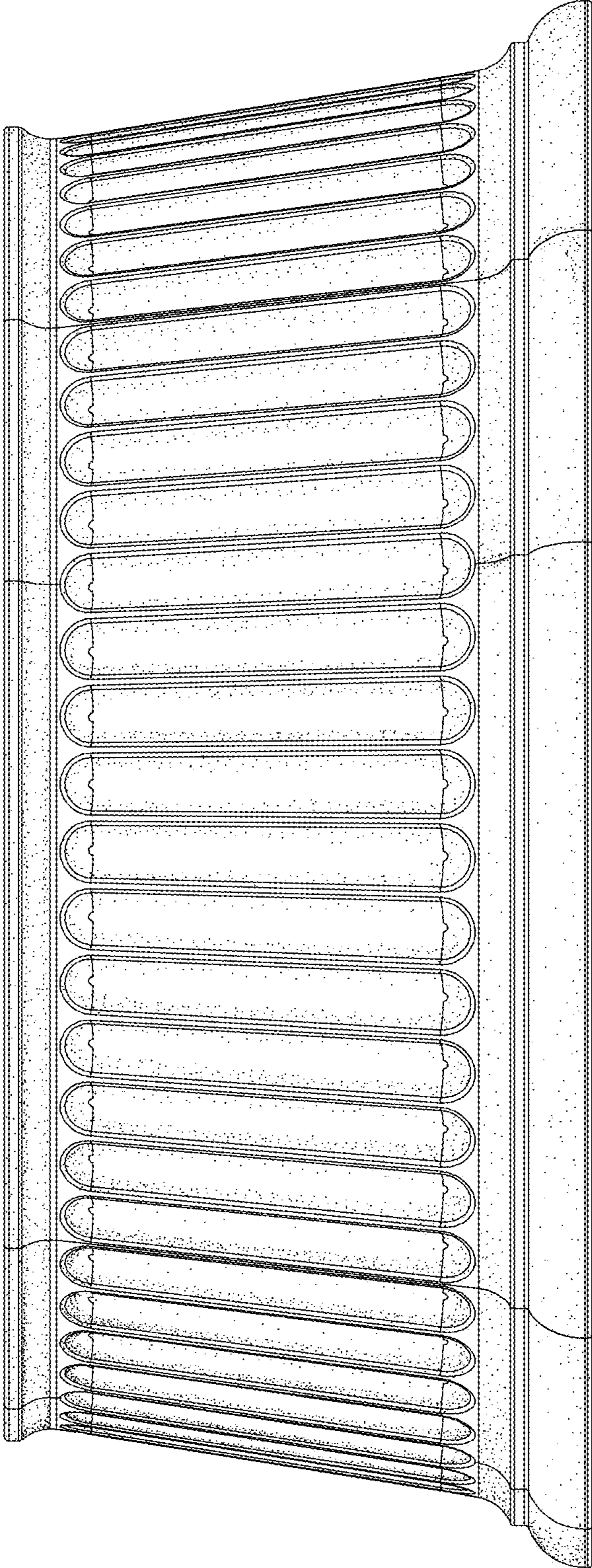

Fig. 3

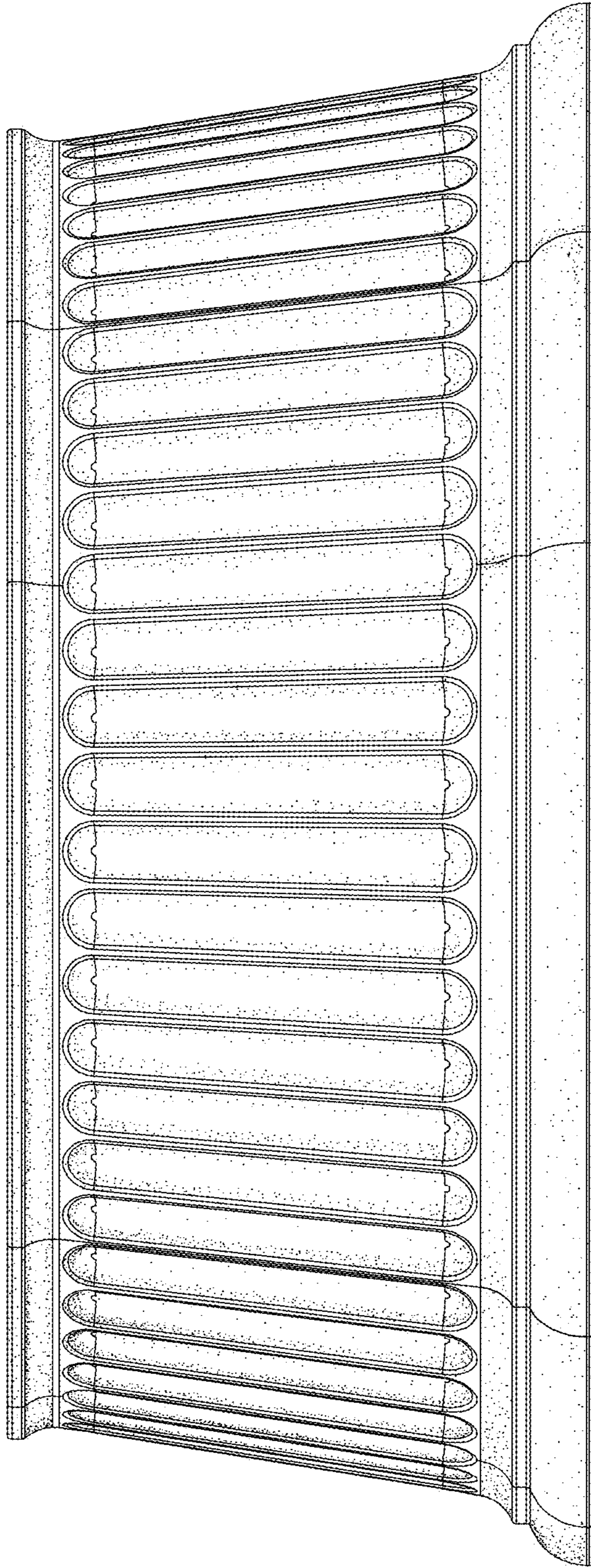

Fig. 4

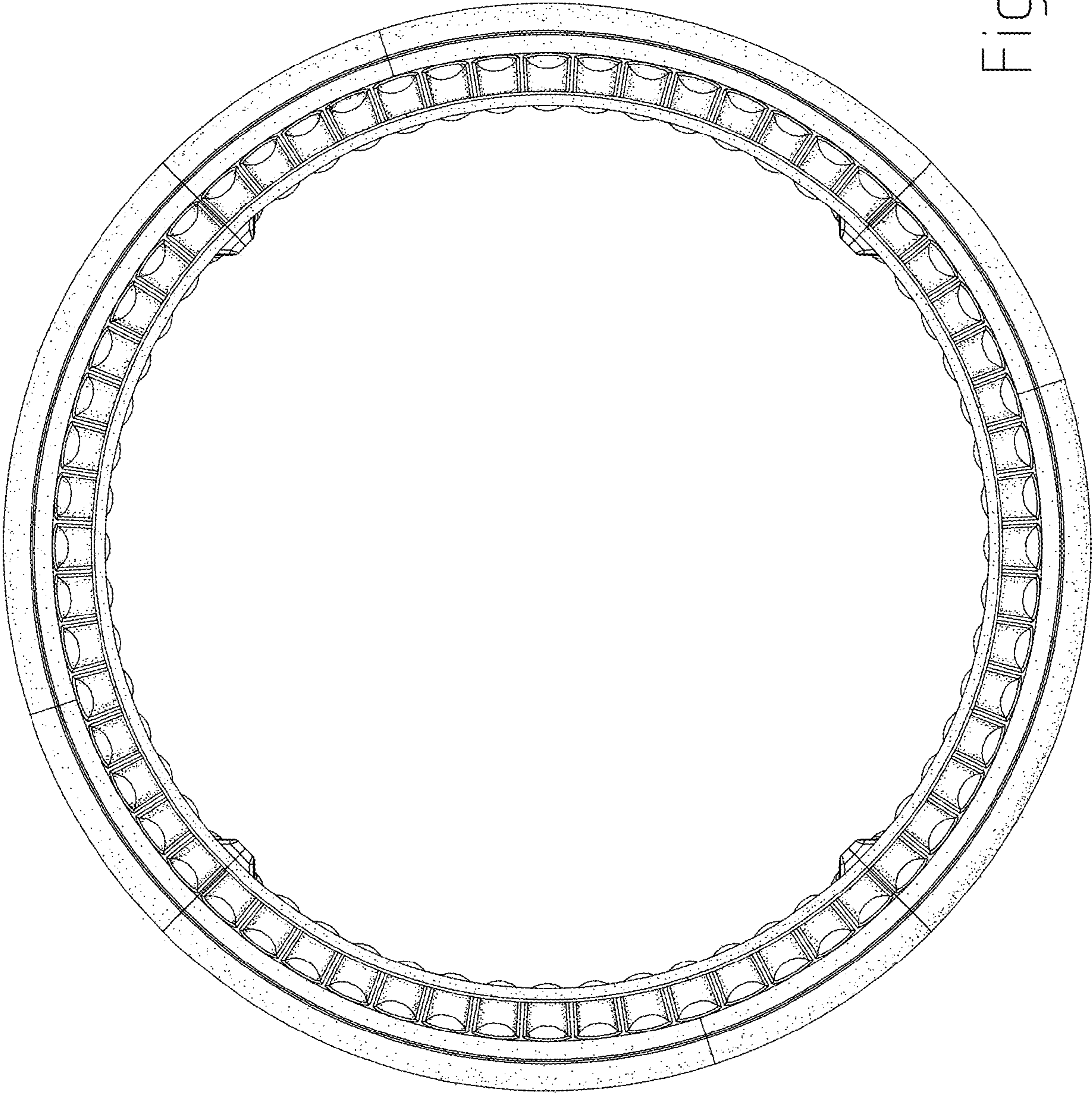

Fig. 5

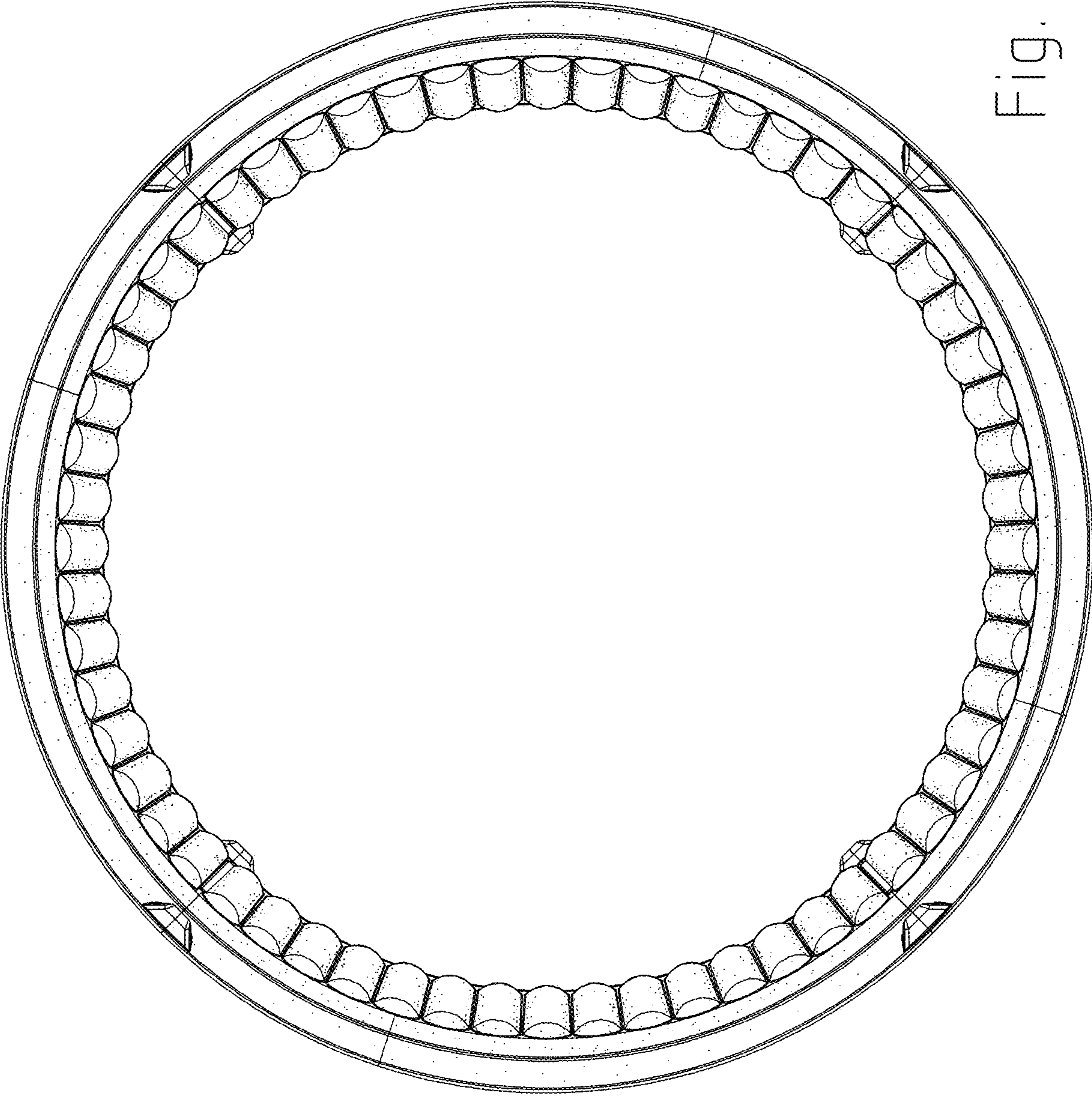

Fig. 6

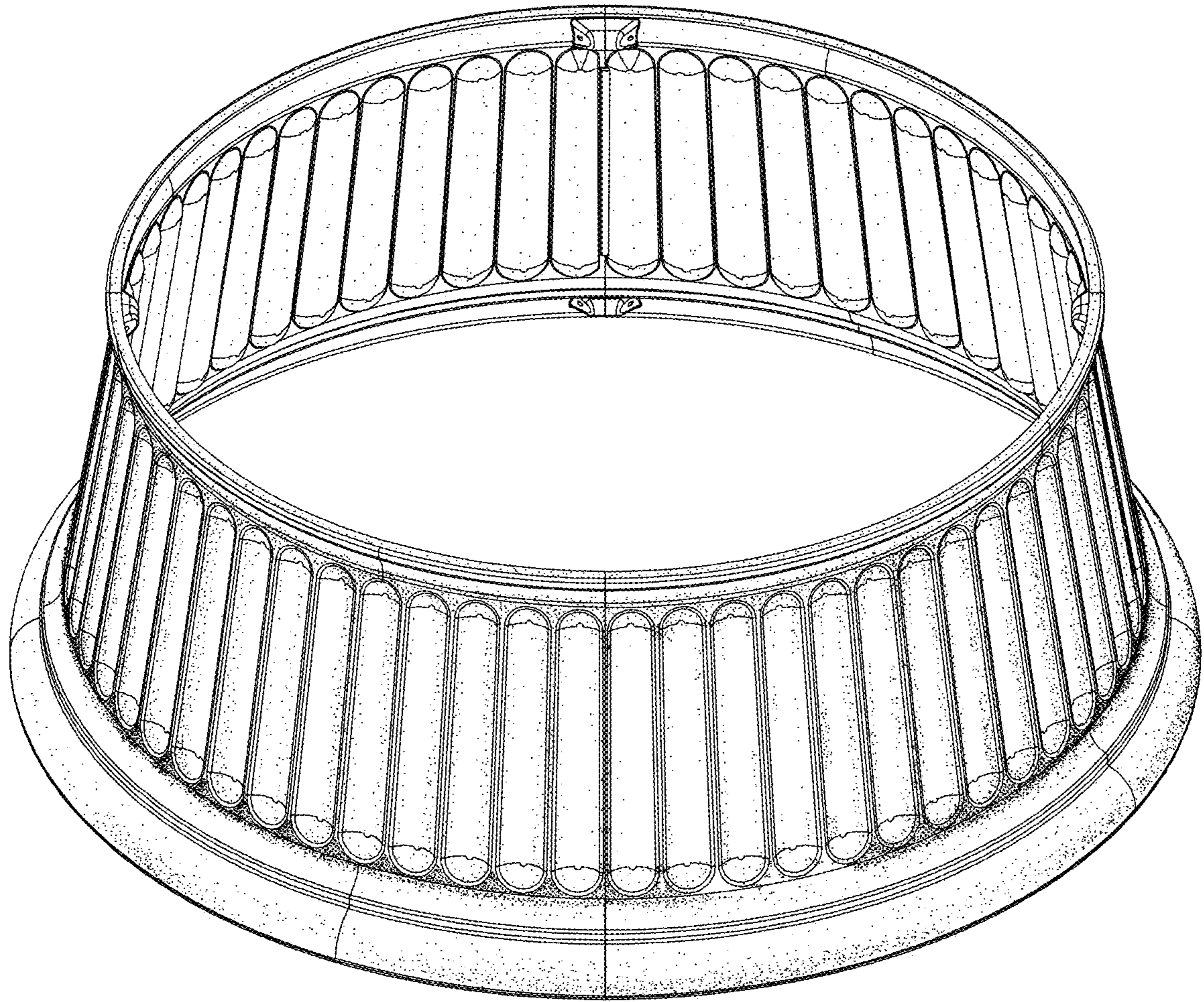

Fig. 7