



US00D985409S

(12) **United States Design Patent** (10) **Patent No.:** **US D985,409 S**
Huang (45) **Date of Patent:** **** May 9, 2023**

(54) **PROTECTIVE CASE FOR A WATCH**

(71) Applicant: **Wei Huang**, Hechi (CN)

(72) Inventor: **Wei Huang**, Hechi (CN)

(**) Term: **15 Years**

(21) Appl. No.: **29/858,155**

(22) Filed: **Oct. 28, 2022**

(30) **Foreign Application Priority Data**

Sep. 23, 2022 (CN) 202230630596.9
Oct. 10, 2022 (CN) 202230665379.3

(51) **LOC (14) Cl.** **10-07**

(52) **U.S. Cl.**
USPC **D10/132**

(58) **Field of Classification Search**
USPC D10/30-39, 122, 128, 129-132; D11/3;
D14/344, 440

(Continued)

(56) **References Cited**

U.S. PATENT DOCUMENTS

D766,906 S * 9/2016 Kim D14/440
D770,931 S * 11/2016 Parker D10/132

(Continued)

FOREIGN PATENT DOCUMENTS

CN 307711984 * 12/2022
CN 307755206 * 12/2022

OTHER PUBLICATIONS

Goton 2 in 1 Waterproof Rugged Case for Apple Watch | amazon.com; date first avail. Sep. 15, 2022 [online]. © 1996-2022, Amazon.com, Inc [retrieved Dec. 14, 2022] from Internet: <https://www.amazon.com/Goton-Waterproof-Protector-Protective-Accessories/dp/B0BC7CPZPQ?ref_ast_sto_dp&th=1> (Year: 2022).*

(Continued)

Primary Examiner — Katherine Glennon

(74) *Attorney, Agent, or Firm* — Georgi Korobanov

(57) **CLAIM**

The ornamental design for a protective case for a watch, as shown and described.

DESCRIPTION

FIG. 1 is a front, right and top perspective view of a first embodiment of a protective case for a watch, showing my new design;

FIG. 2 is a rear, left and bottom perspective view thereof;

FIG. 3 is a front, right and top perspective view of the protective case for a watch in a detached status;

FIG. 4 is a front view of FIG. 1;

FIG. 5 is a rear view thereof;

FIG. 6 is a left side view thereof;

FIG. 7 is a right side view thereof;

FIG. 8 is a top plan view thereof;

FIG. 9 is a bottom plan view thereof;

FIG. 10 is a front, right and top perspective view of a second embodiment of a protective case for a watch;

FIG. 11 is a rear, left and bottom perspective view thereof;

FIG. 12 is a front, right and top perspective view of the protective case for a watch in a detached status;

FIG. 13 is a front view of FIG. 10;

FIG. 14 is a rear view thereof;

FIG. 15 is a left side view thereof;

FIG. 16 is a right side view thereof;

FIG. 17 is a top plan view thereof;

FIG. 18 is a bottom plan view thereof;

FIG. 19 is an enlarged view of portion 19 shown in FIG. 10;

FIG. 20 is a front, right and top perspective view of a third embodiment of a protective case for a watch;

FIG. 21 is a rear, left and bottom perspective view thereof;

FIG. 22 is a front, right and top perspective view of the protective case for a watch in a detached status;

FIG. 23 is a front view of FIG. 20;

FIG. 24 is a rear view thereof;

FIG. 25 is a left side view thereof;

FIG. 26 is a right side view thereof;

FIG. 27 is a top plan view thereof;

FIG. 28 is a bottom plan view thereof; and,

(Continued)

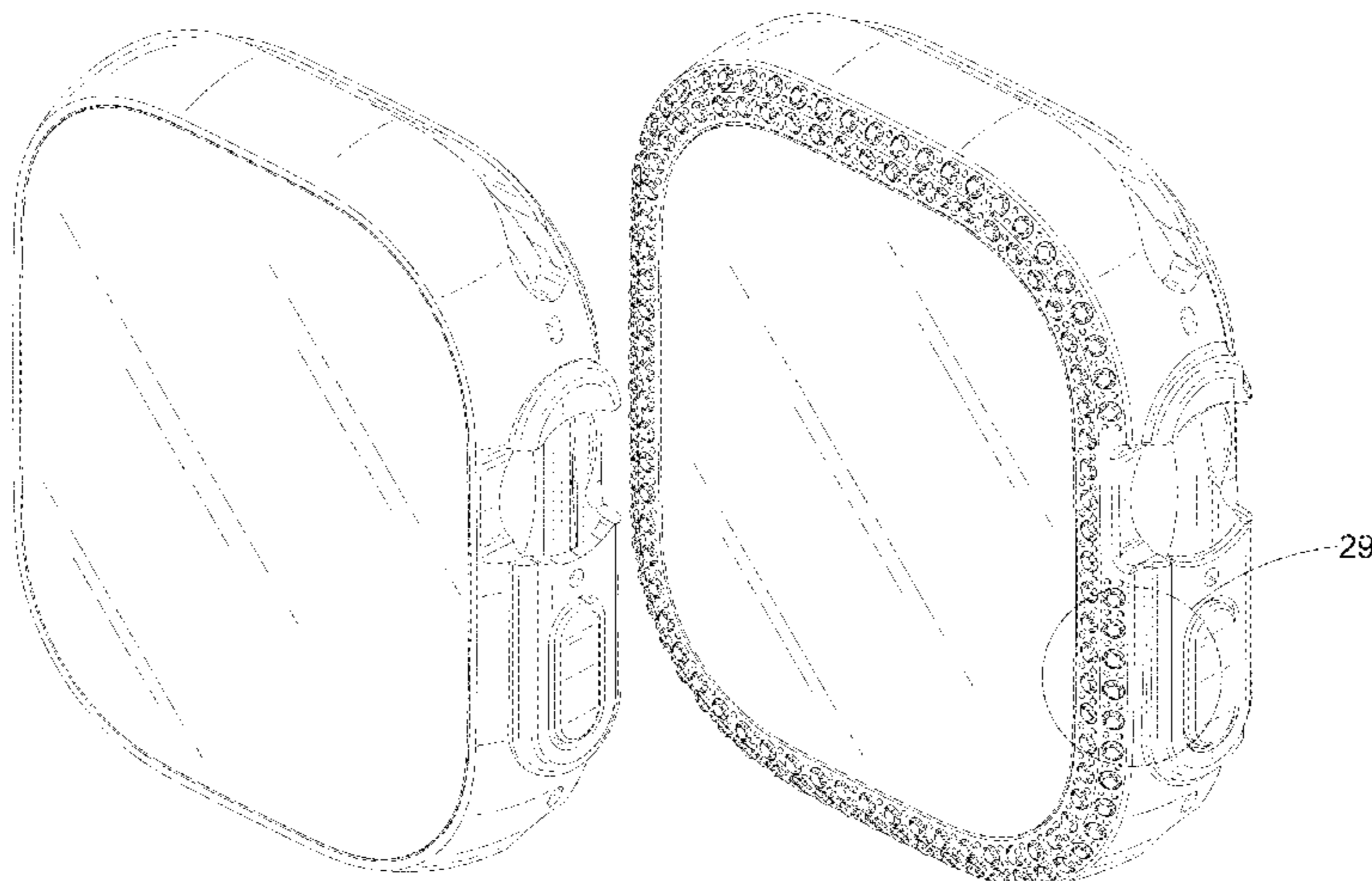

FIG. 29 is an enlarged view of portion 29 shown in FIG. 20. The dot-dash broken lines depict the boundaries of the enlargements that form no part of the claimed design.

1 Claim, 29 Drawing Sheets

(58) **Field of Classification Search**

CPC A44C 5/00; A44C 5/0007; A44C 5/147; A44C 17/02; A45C 2011/001-003; A45C 15/08; A45C 11/10; A45C 11/12; G04B 37/005; G04B 37/0058; G04B 37/084; G04B 37/087; G04G 17/08

See application file for complete search history.

(56) **References Cited**

U.S. PATENT DOCUMENTS

D850,968 S 6/2019 Zhang
 10,575,425 B1 * 2/2020 Deng H05K 5/0086
 D885,230 S * 5/2020 Kim D14/440
 D903,508 S * 12/2020 Zhang D10/30
 D909,903 S * 2/2021 Lin D10/132
 D912,676 S * 3/2021 Wright D14/440

D920,147 S * 5/2021 Liu D14/440
 D925,385 S 7/2021 Lin
 D949,038 S * 4/2022 Hu D10/132
 D952,496 S * 5/2022 Yu D10/30
 D954,584 S * 6/2022 Zhou D10/132
 D961,597 S * 8/2022 Painter D14/440
 D964,875 S * 9/2022 Lin D11/91
 D970,377 S * 11/2022 Liu D10/132
 D974,287 S * 1/2023 Painter D13/103
 D978,005 S * 2/2023 Liu D10/132
 2019/0369563 A1 * 12/2019 Chen F16J 15/022

OTHER PUBLICATIONS

Tensea 2 in 1 Waterproof Apple Watch Screen Protector | amazon.com; first avail Sep. 7, 2022 [online]. © 1996-2022, Amazon.com, Inc [retrieved Dec. 14, 2022] from Internet: <https://www.amazon.com/Tensea-Waterproof-Protector-Accessories-Protective/dp/B0BBG3FL1S/ref=psdc_10048700011_t2_B0BHHTBFW9?th=1> (Year: 2022).*

2-in-1 Bling Waterproof Case Compatible for Apple Watch | amazon.com; date first available Jan. 6, 2023 [online]. © 1996-2023, Amazon.com, Inc [retrieved Jan. 27, 2023] from Internet: <https://www.amazon.com/dp/B0BRSVKY3B/ref=emc_b_5_i?th=1> (Year: 2023).*

* cited by examiner

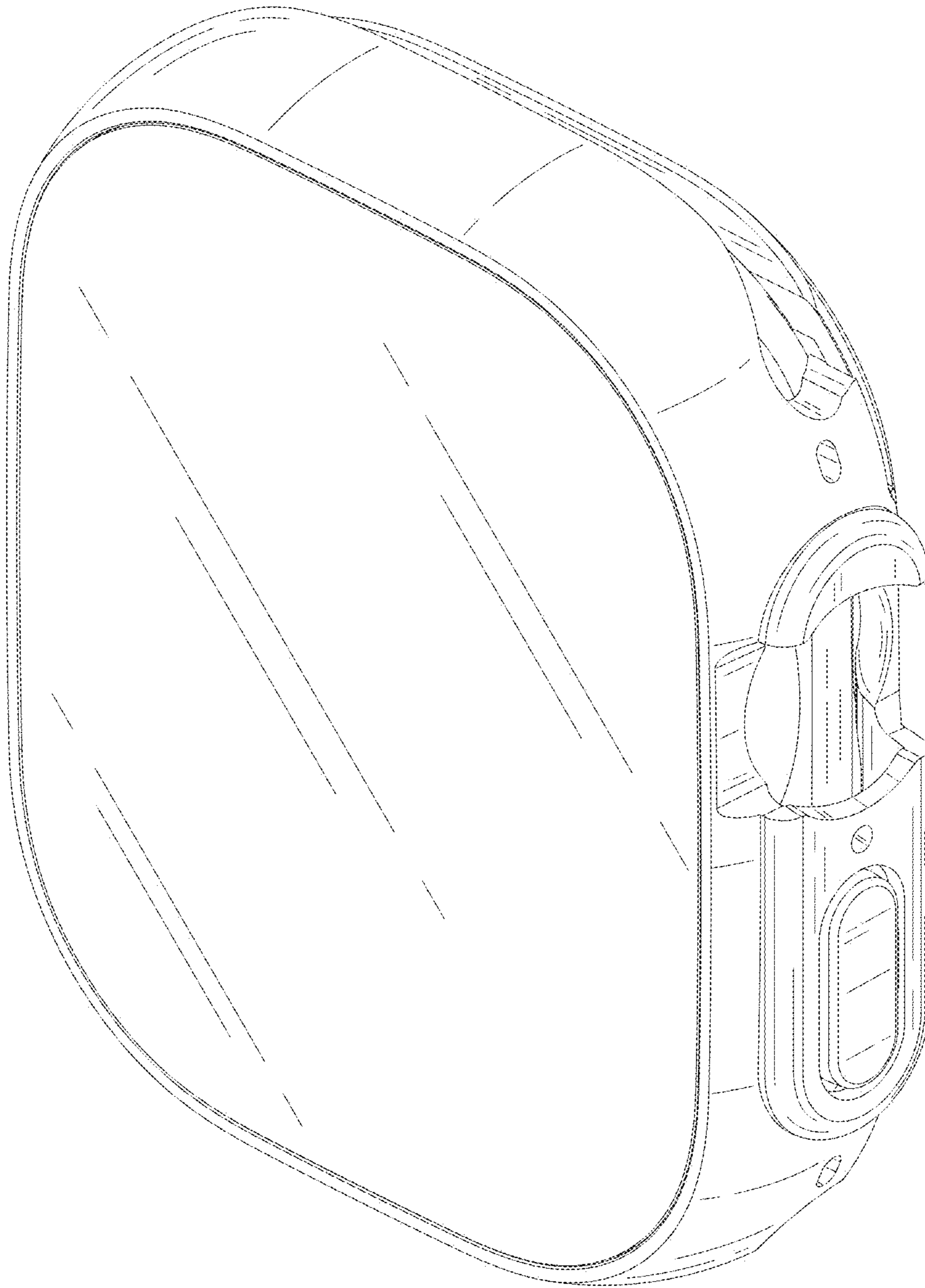

FIG. 1

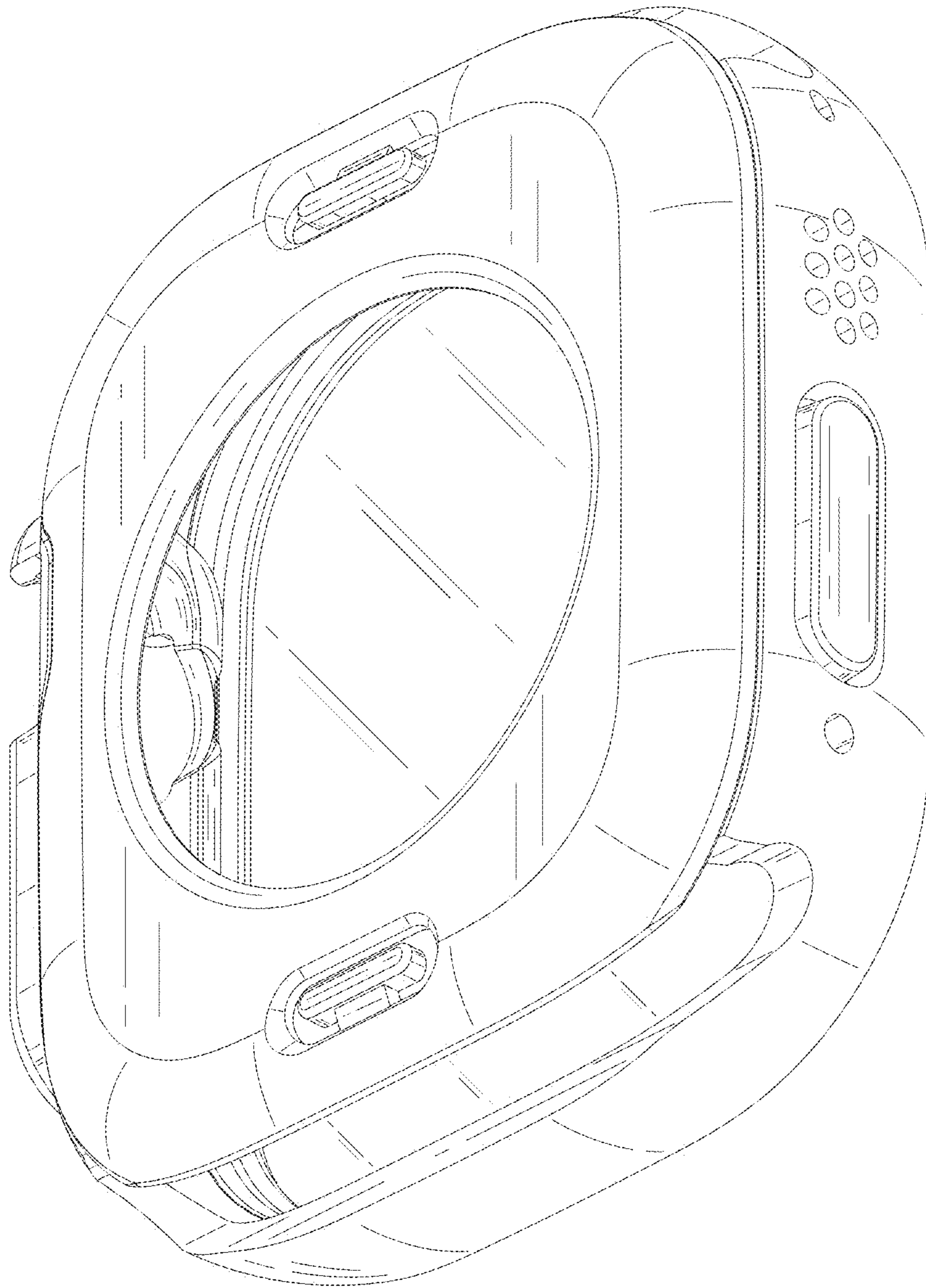

FIG. 2

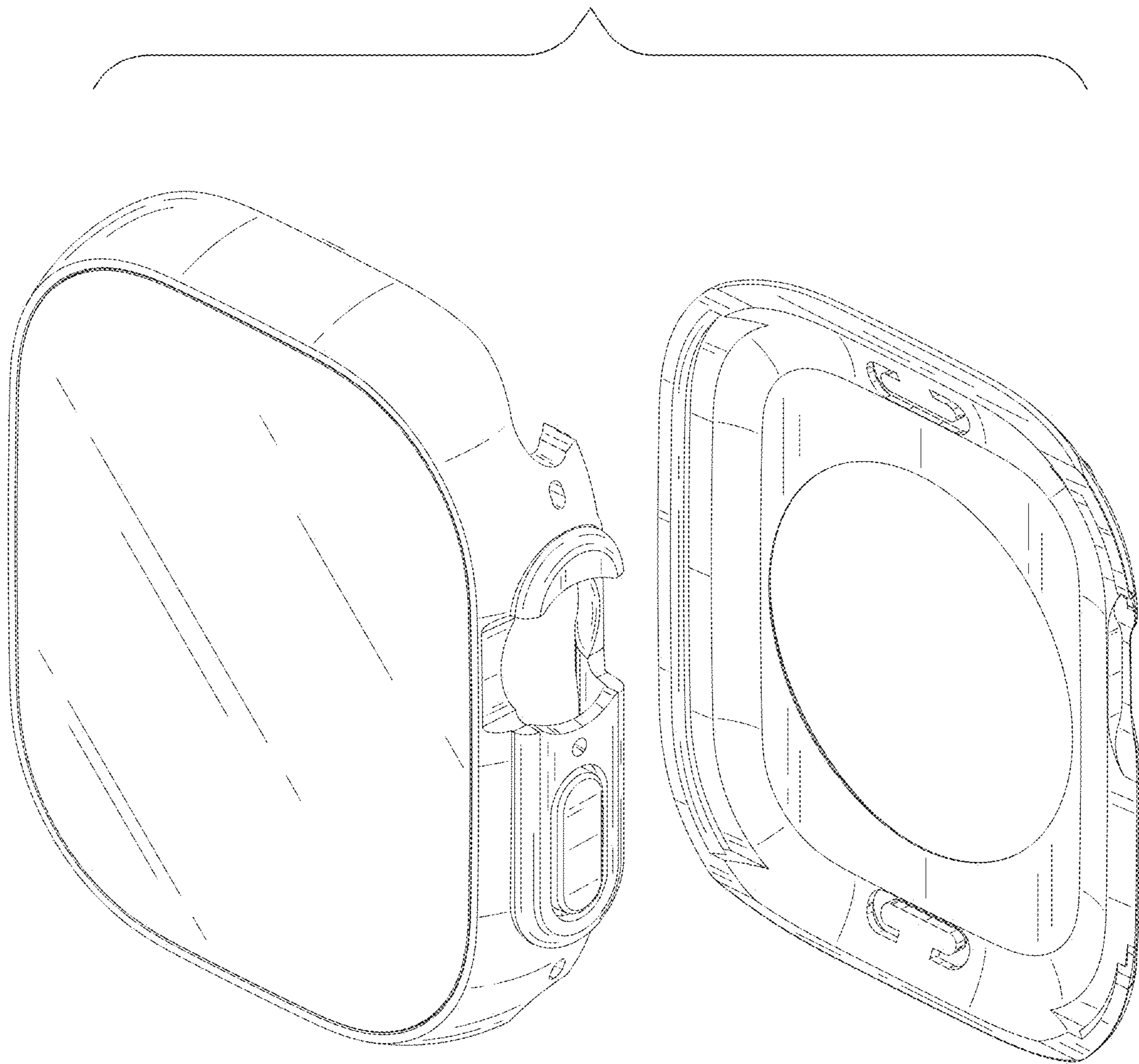

FIG. 3

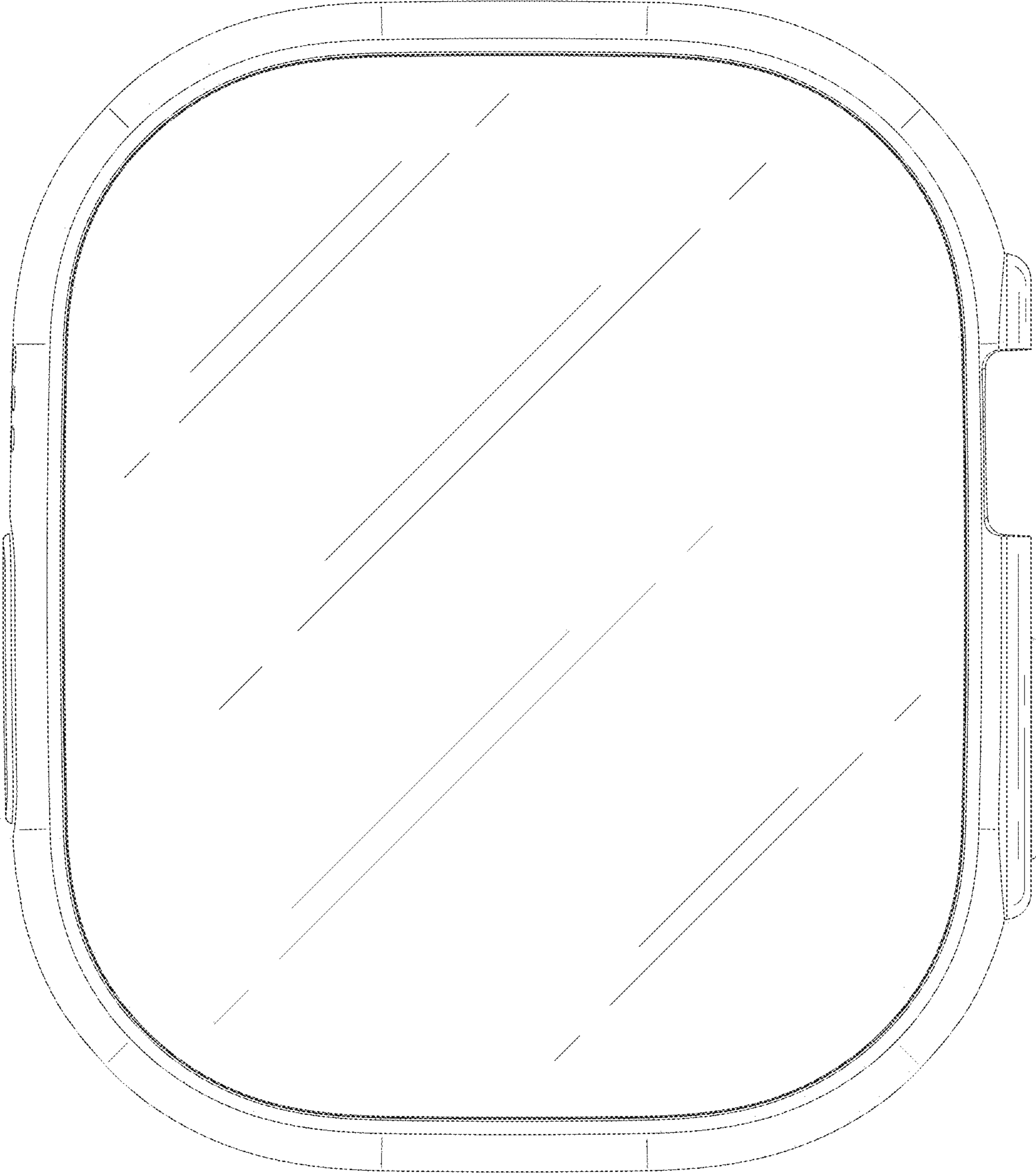

FIG. 4

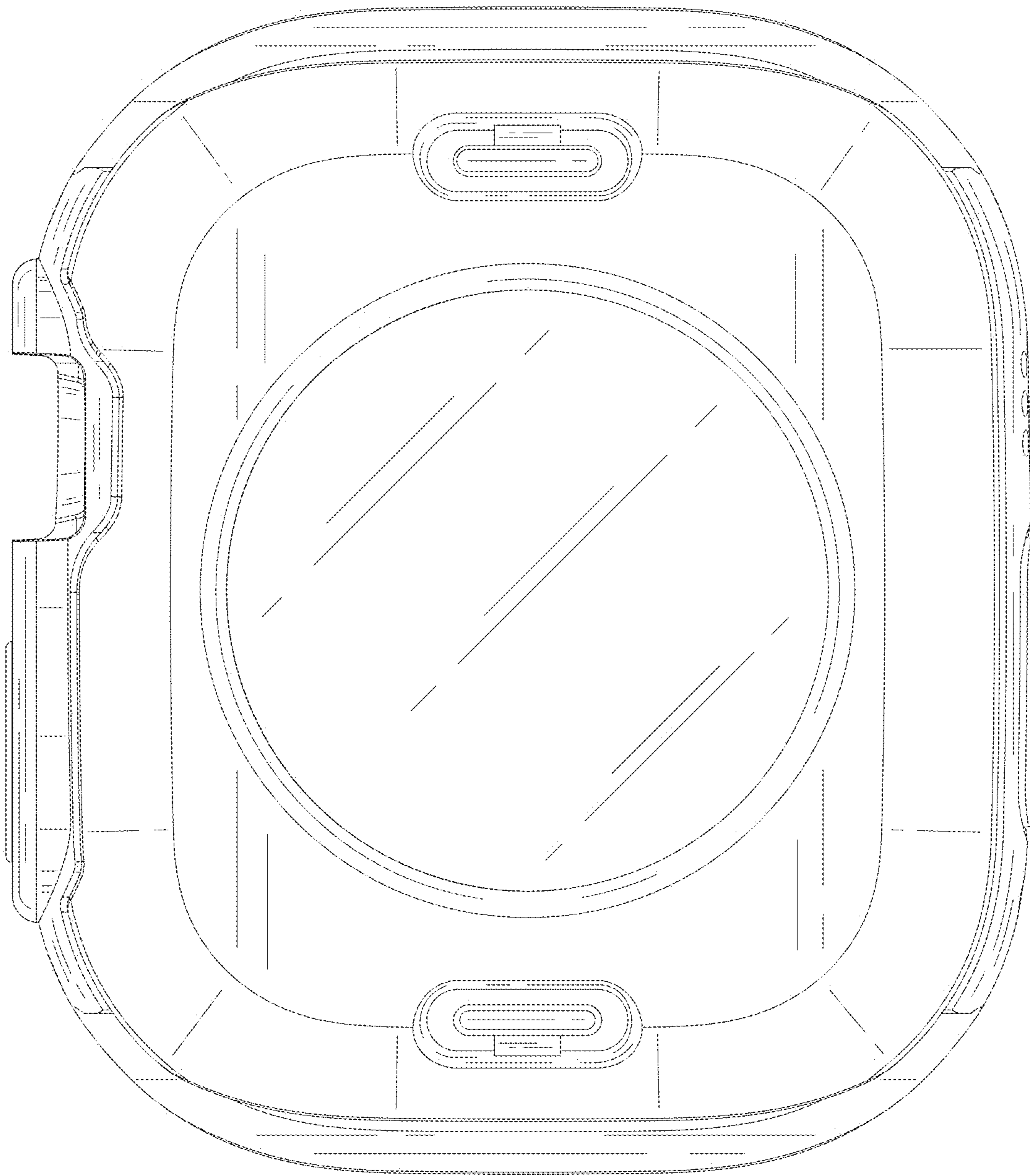

FIG. 5

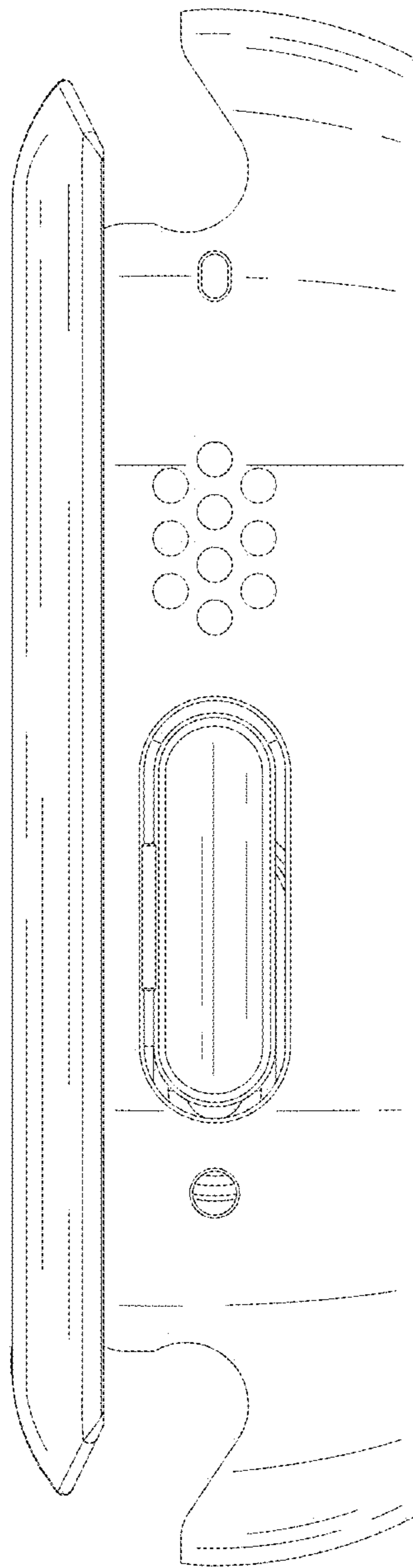

FIG. 6

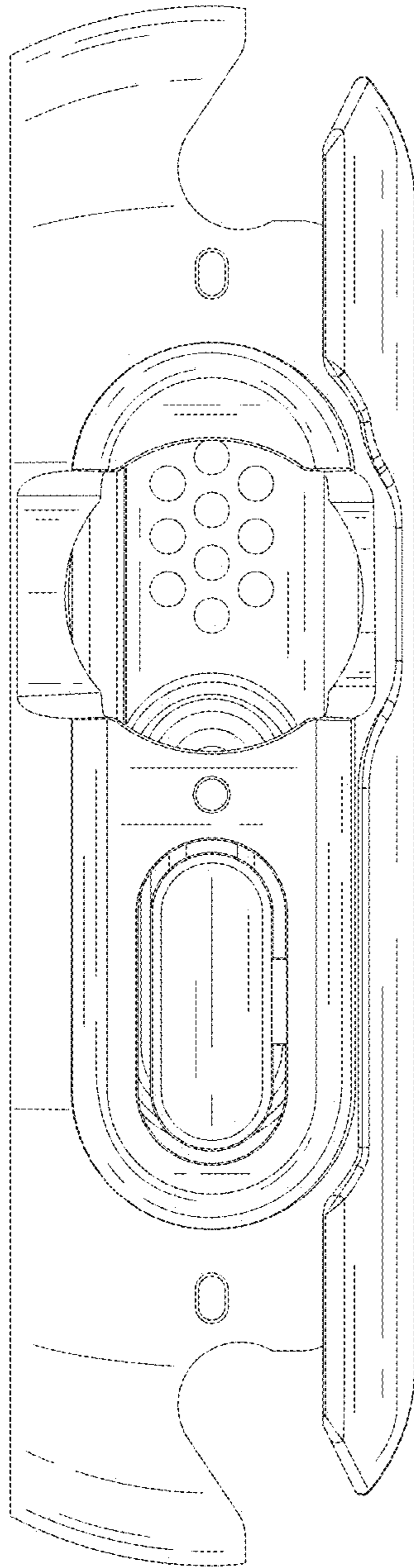

FIG. 7

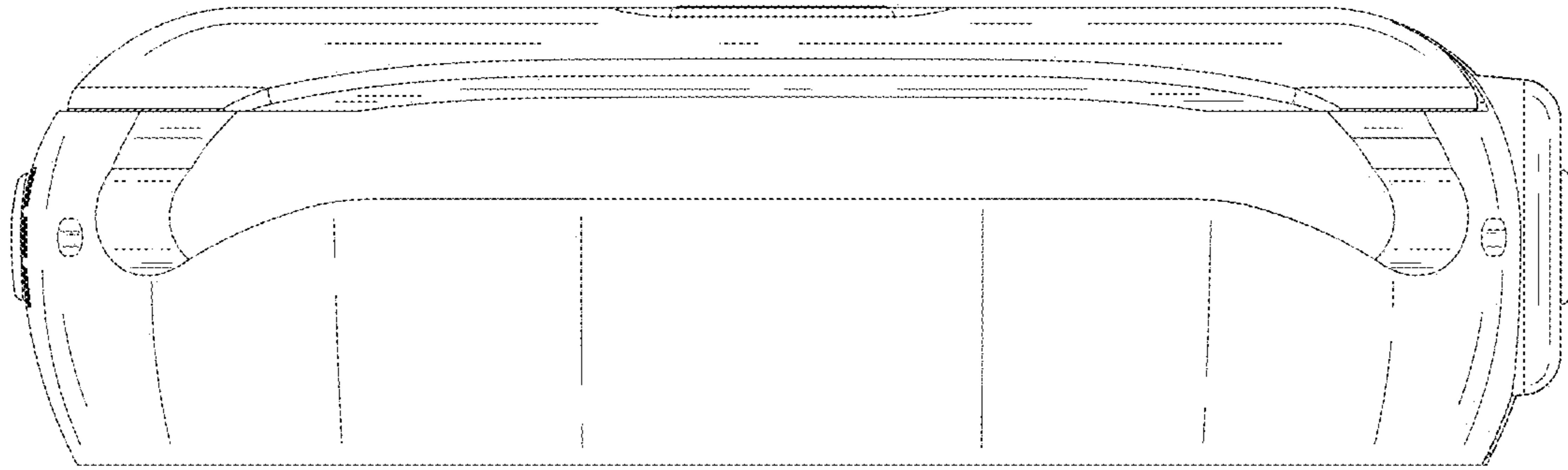

FIG. 8

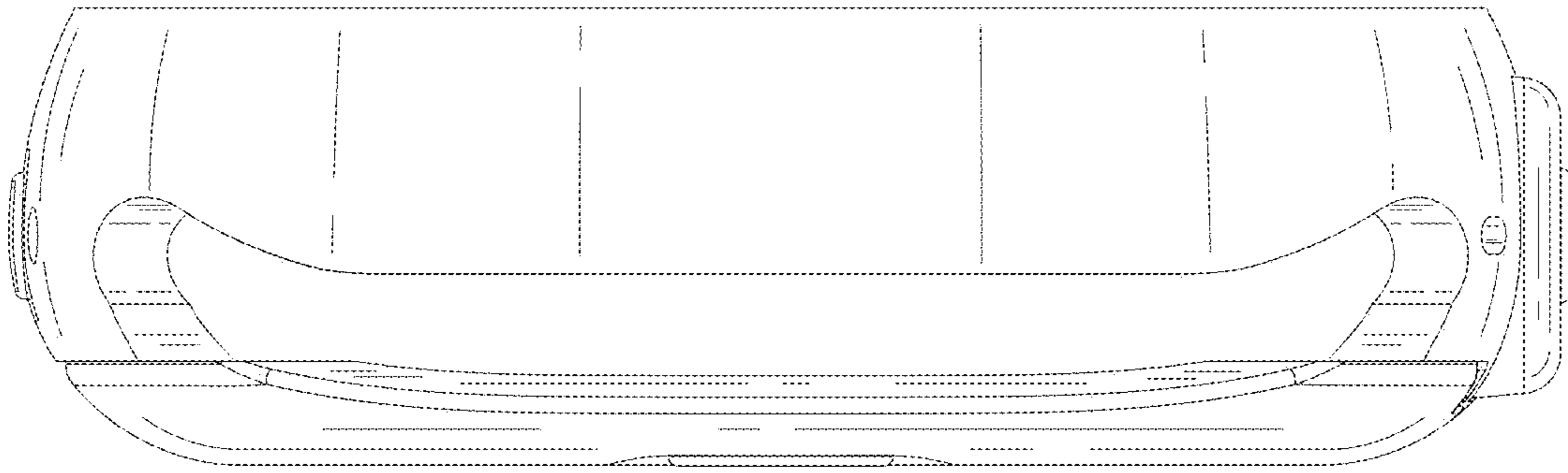

FIG. 9

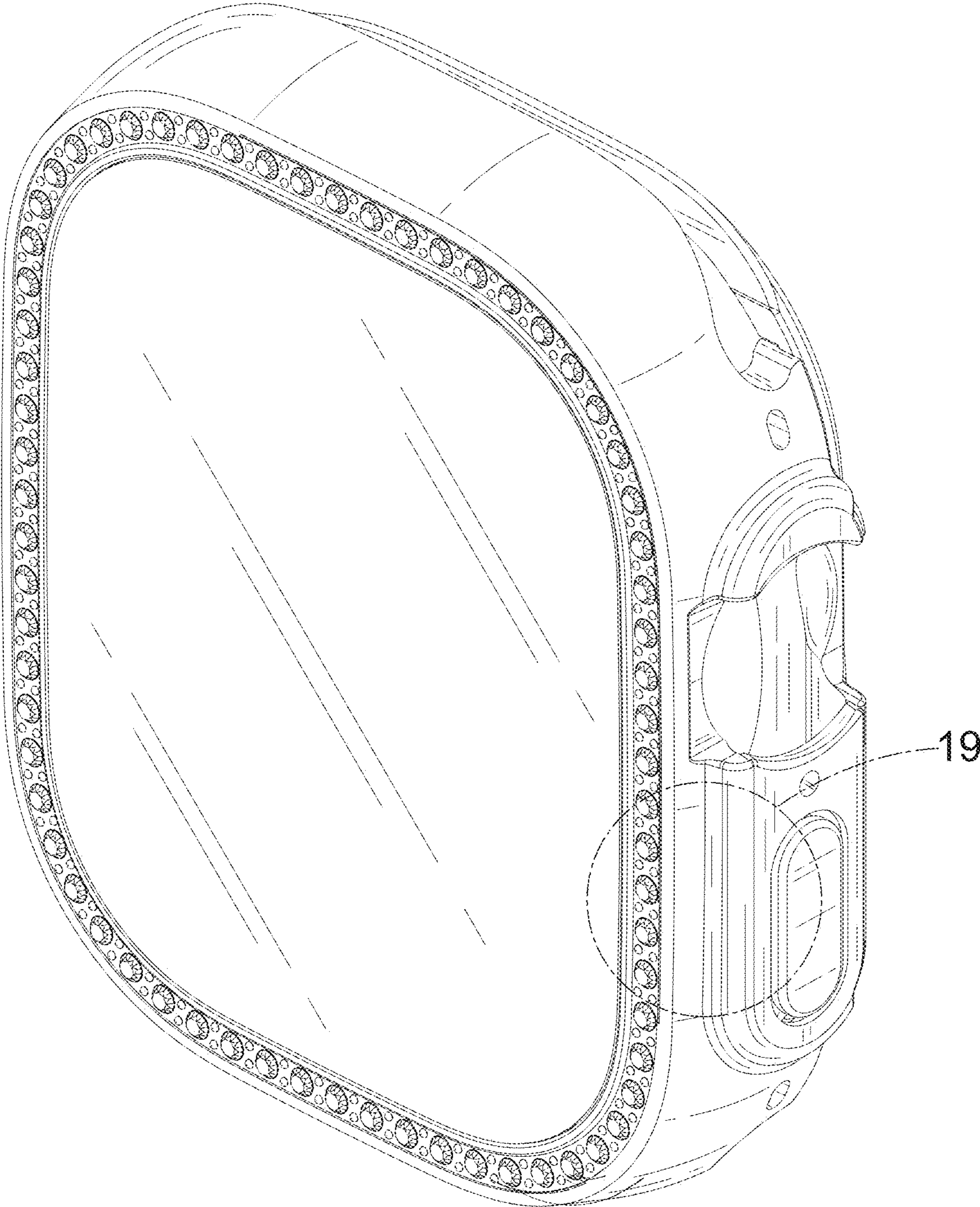

FIG. 10

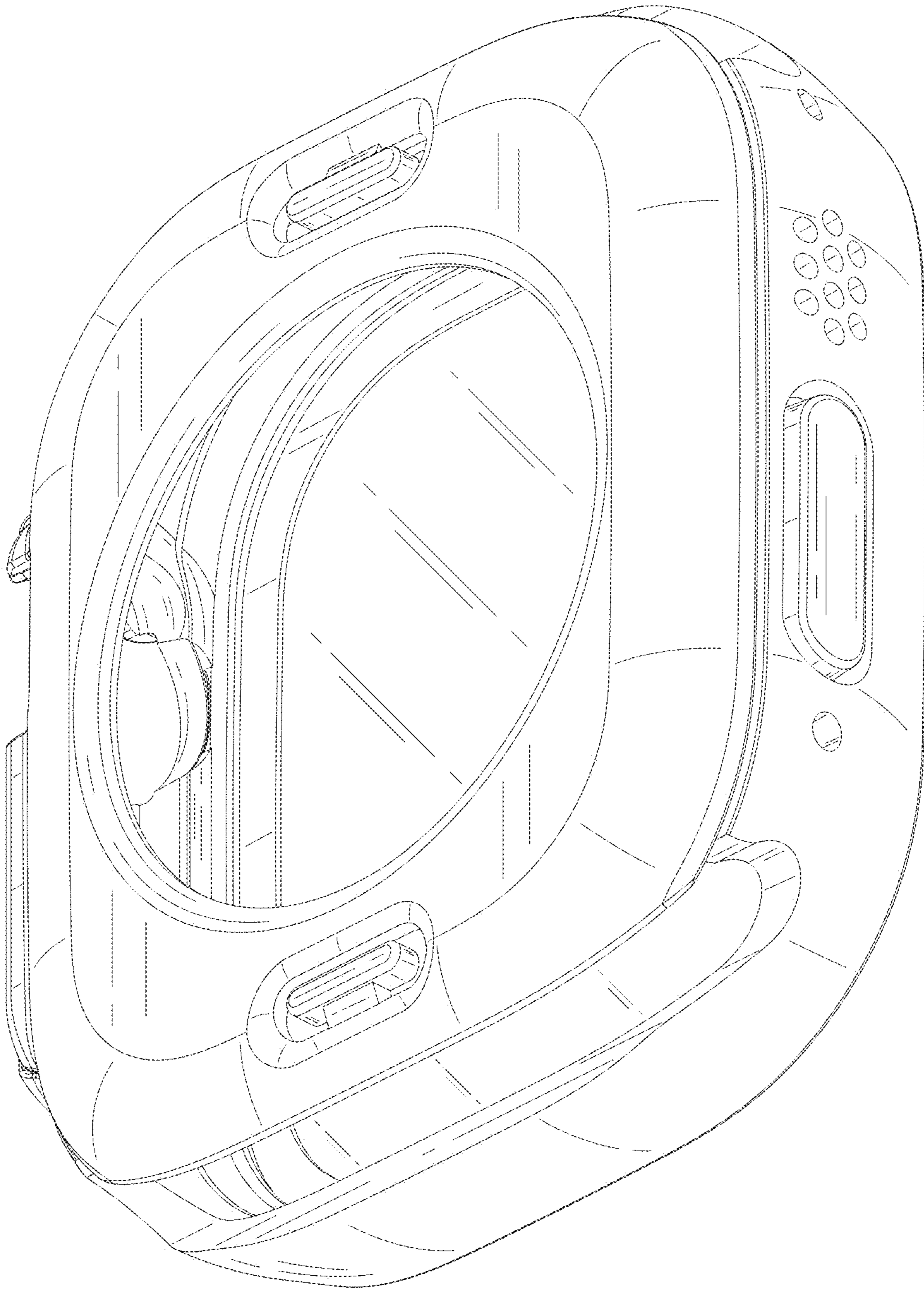

FIG. 11

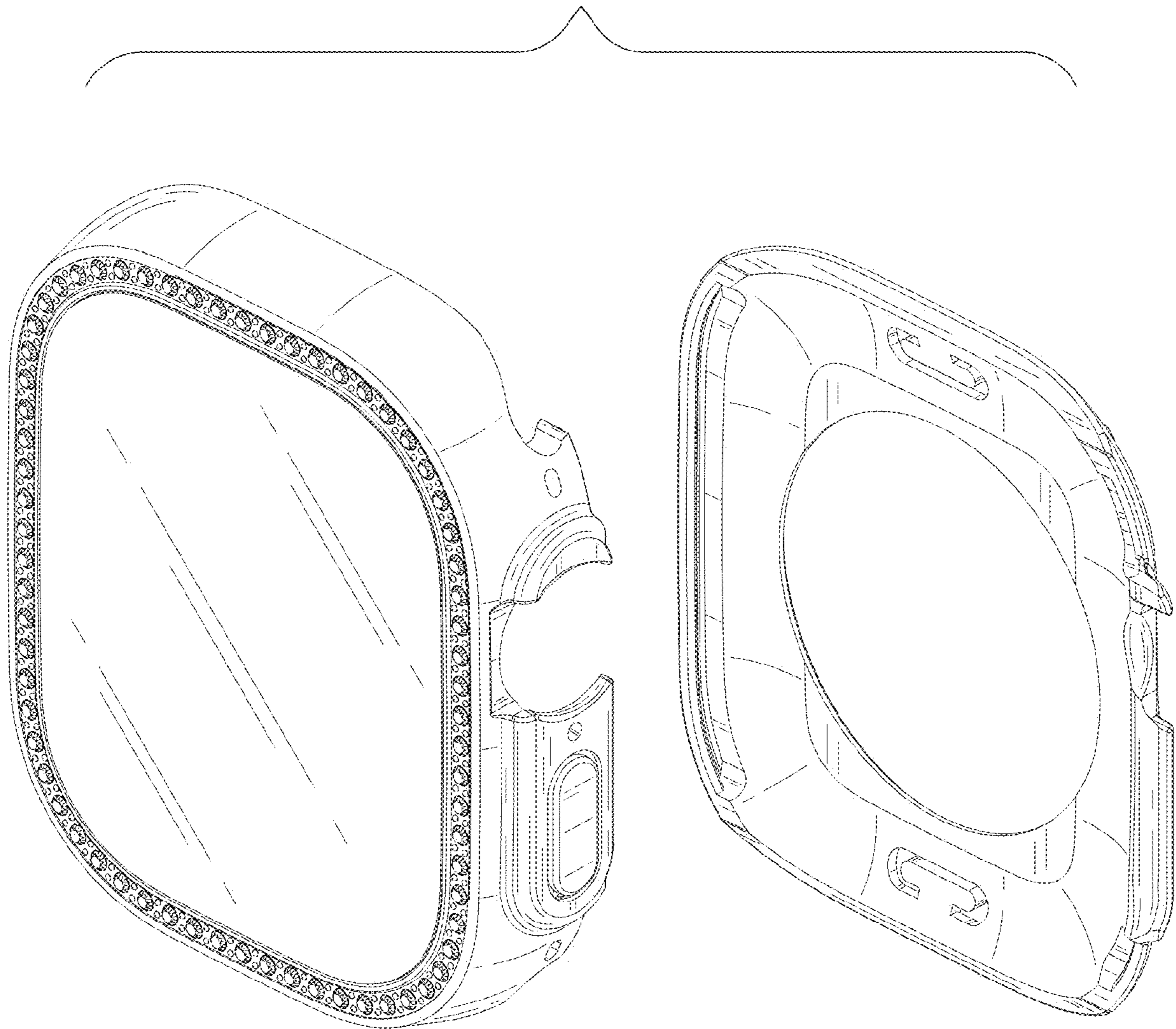

FIG. 12

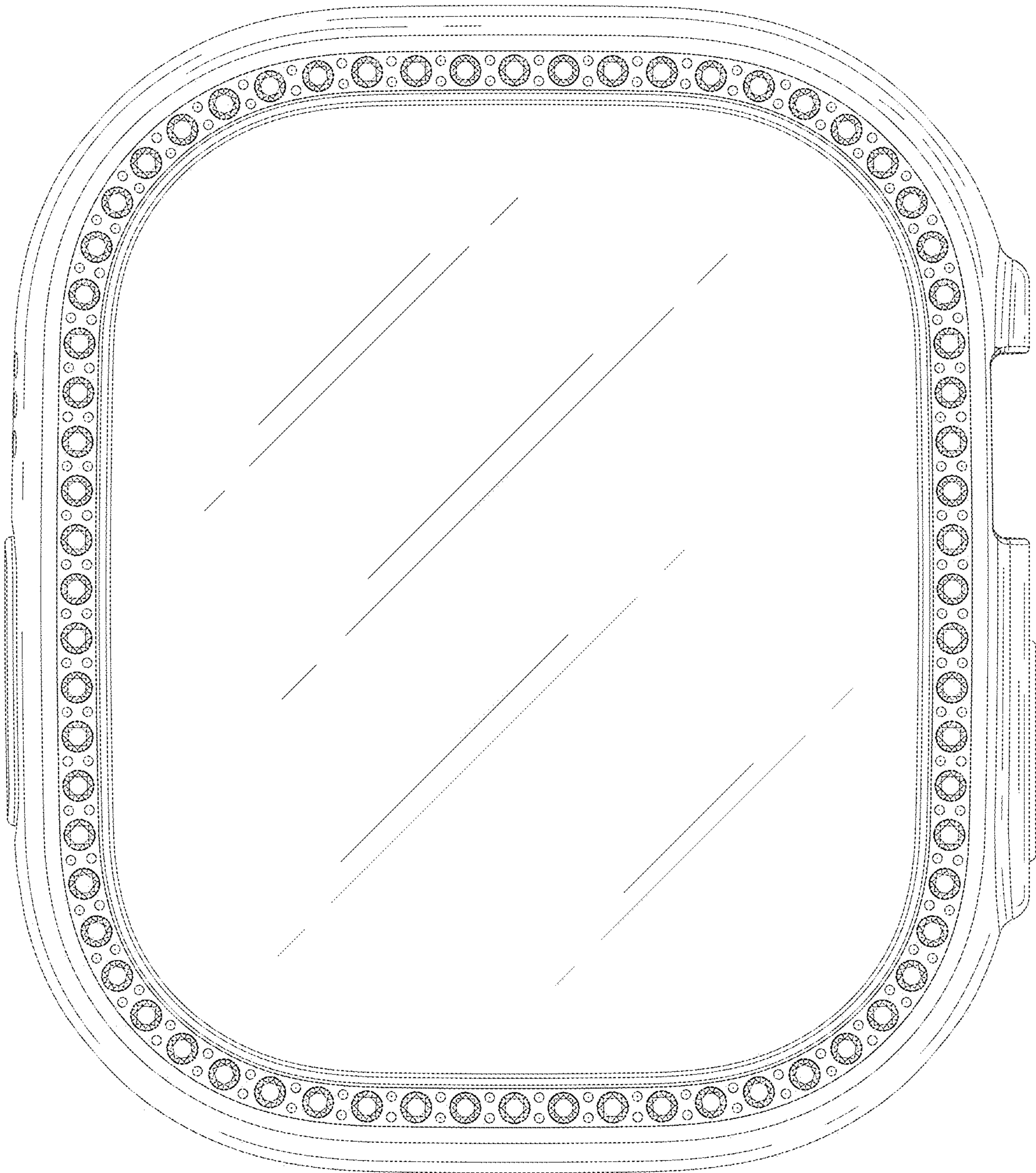

FIG. 13

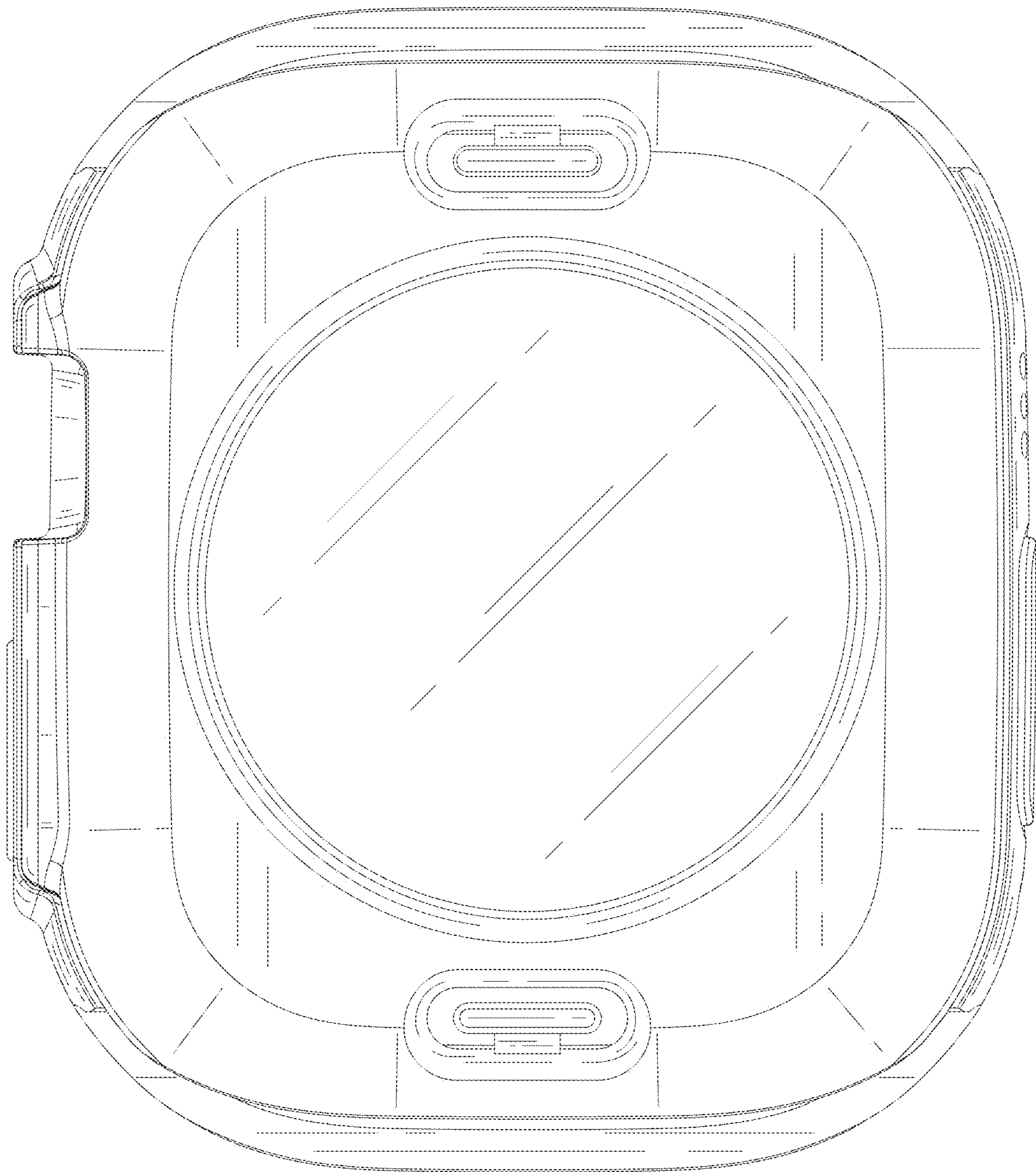

FIG. 14

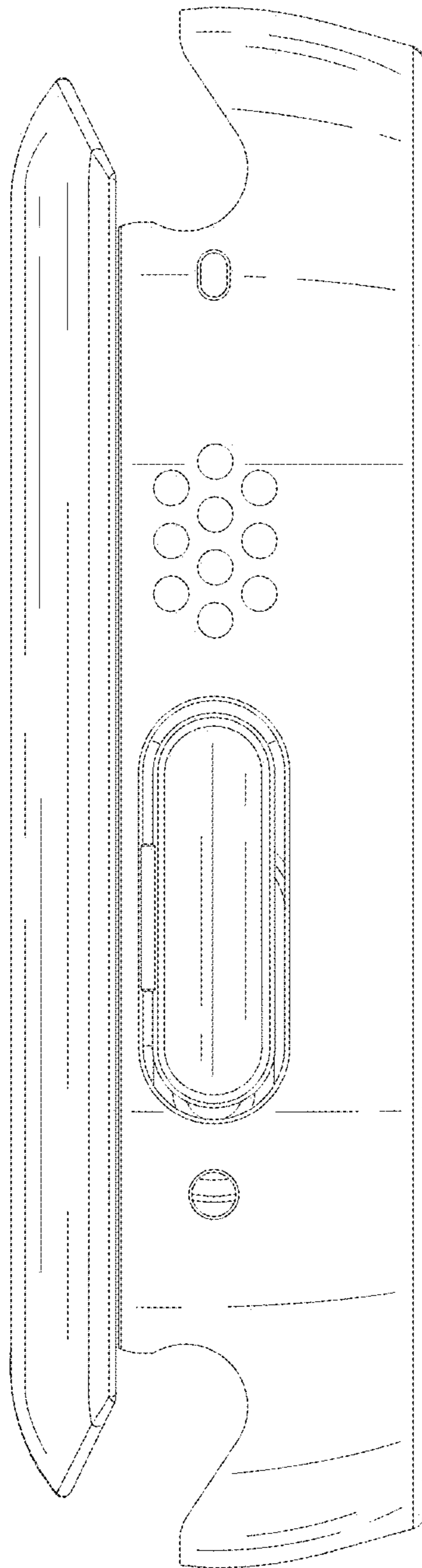

FIG. 15

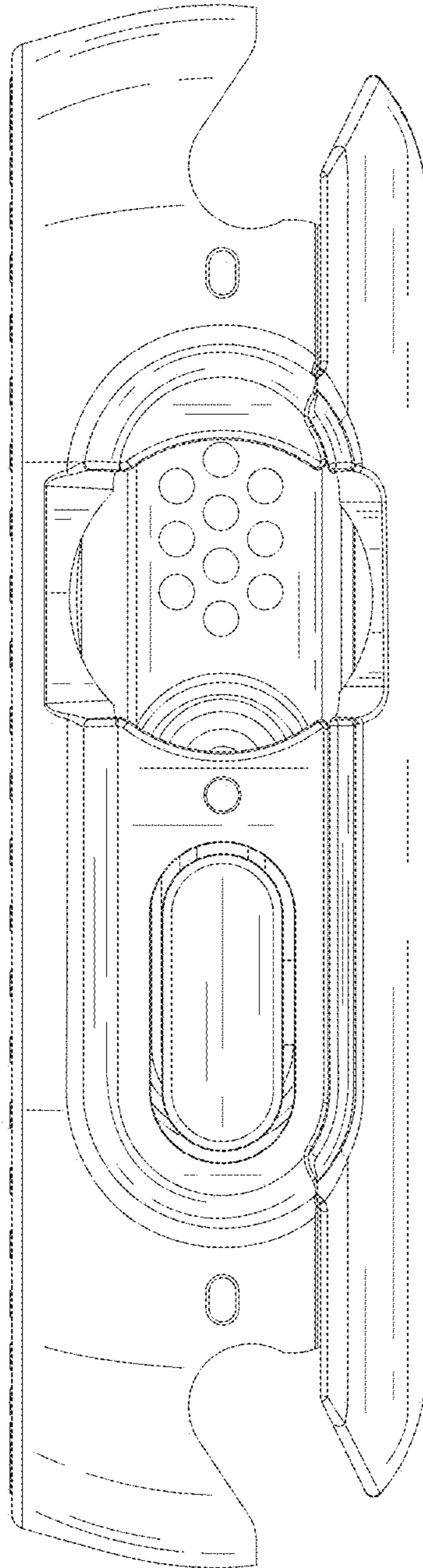

FIG. 16

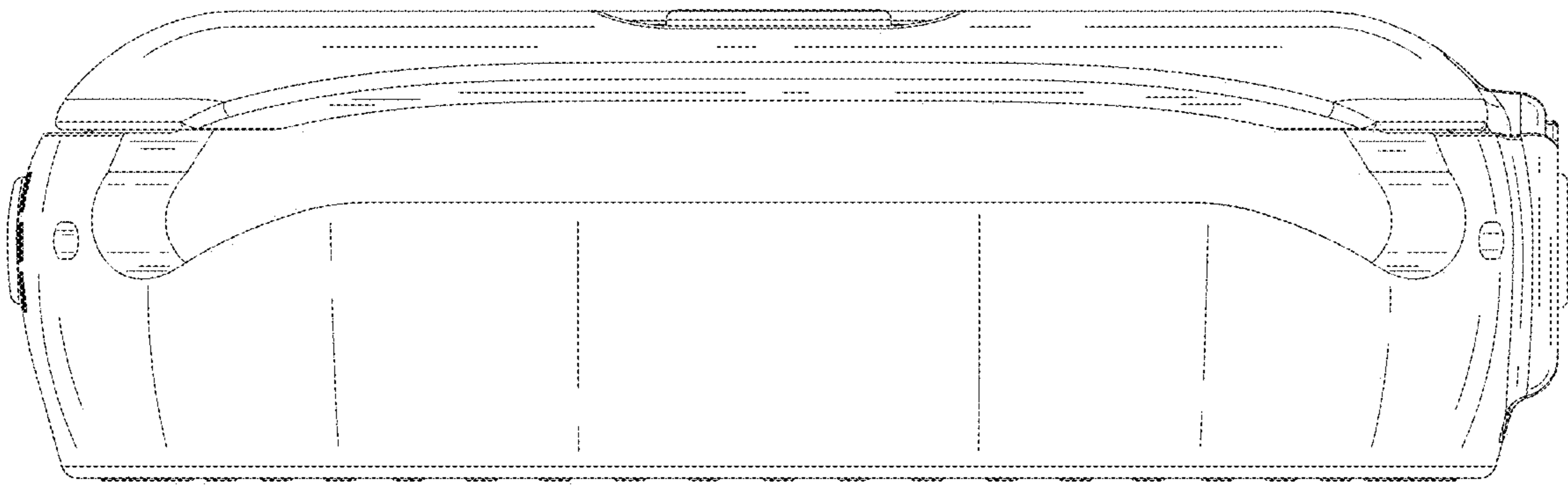

FIG. 17

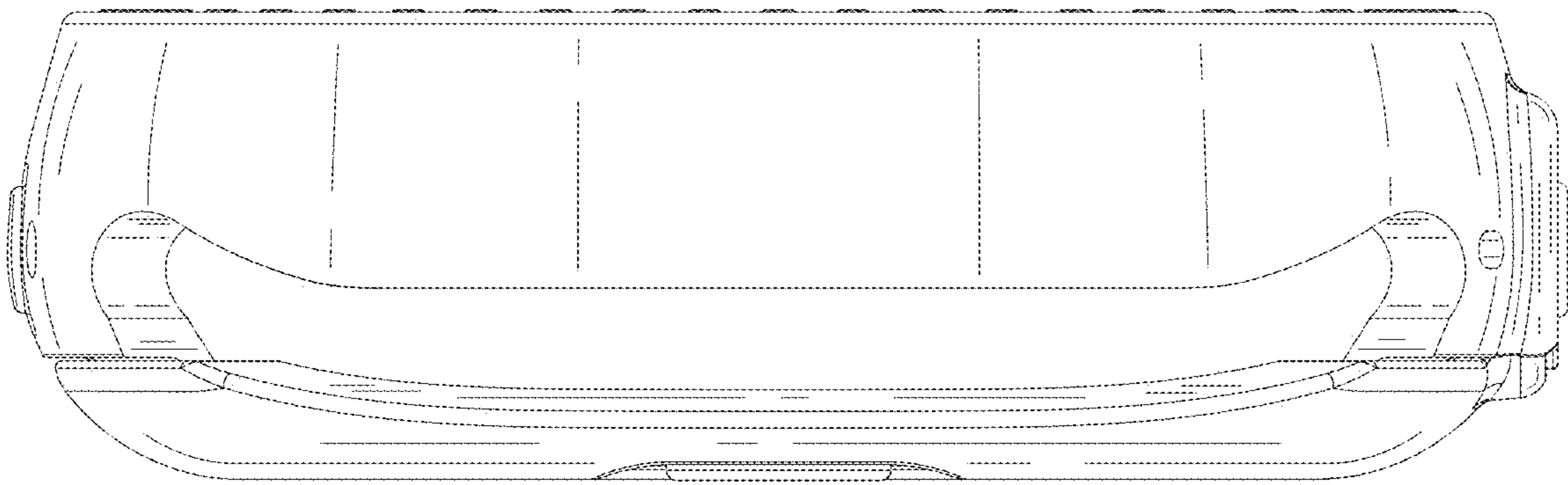

FIG. 18

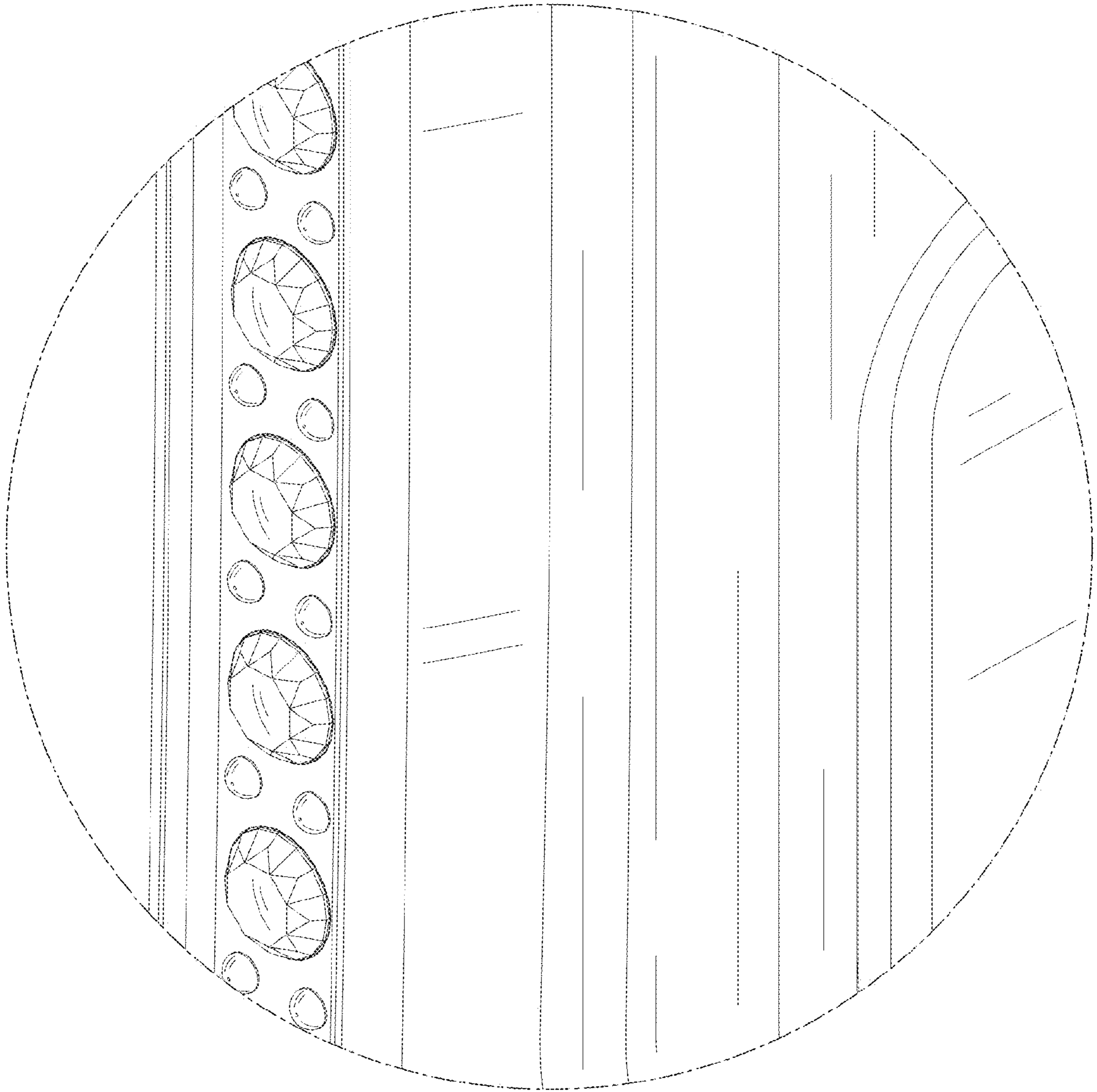

FIG. 19

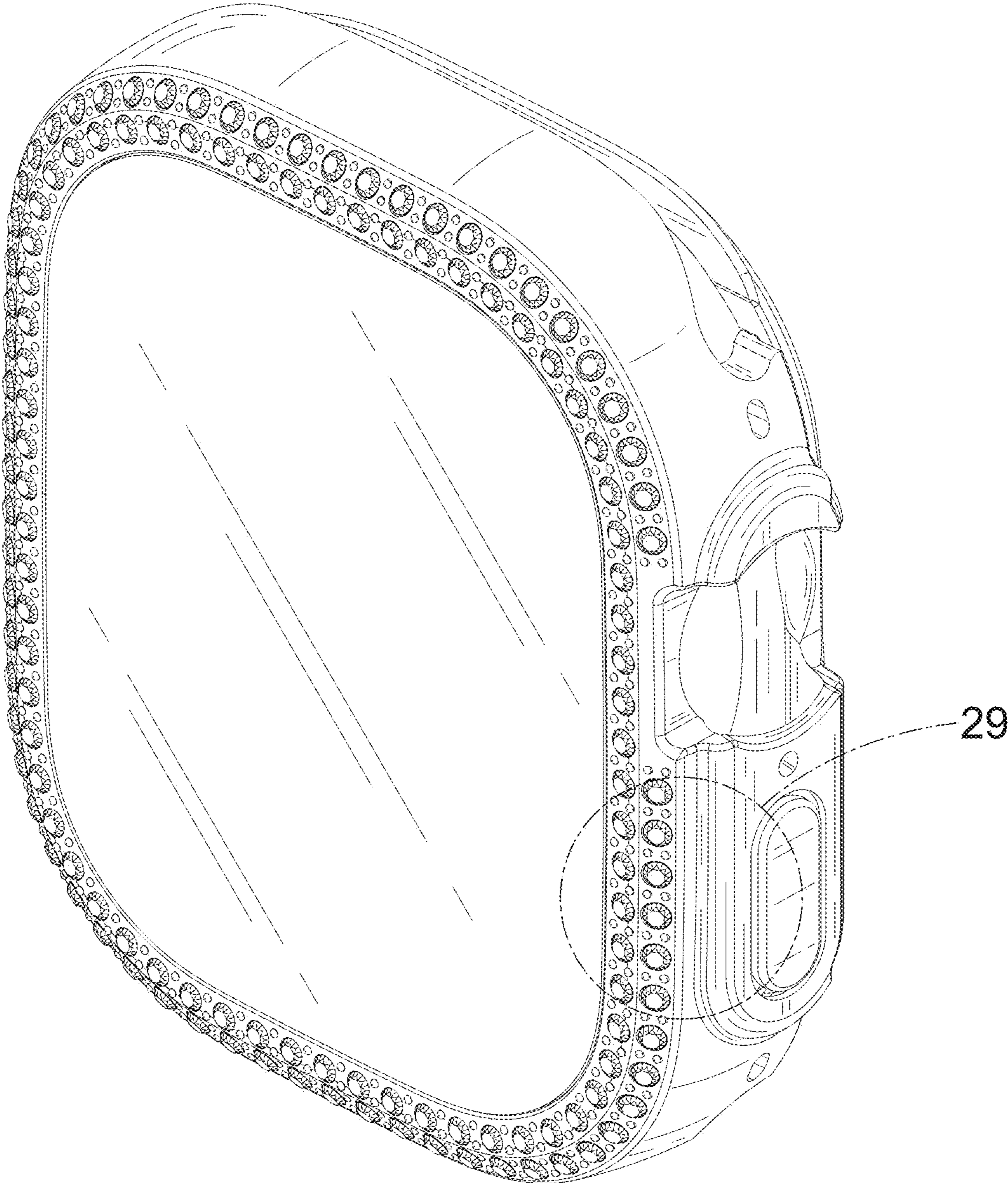

FIG. 20

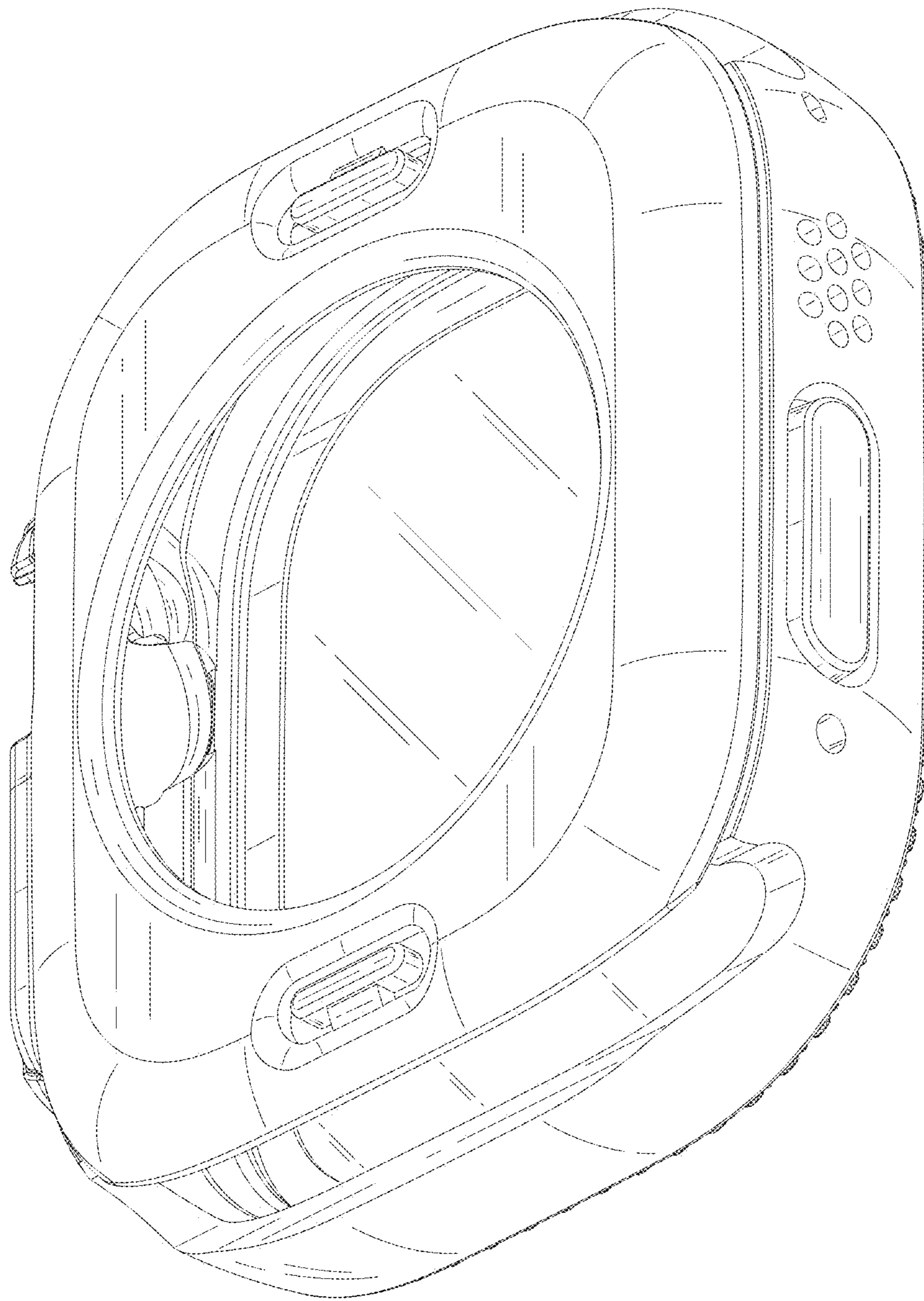

FIG. 21

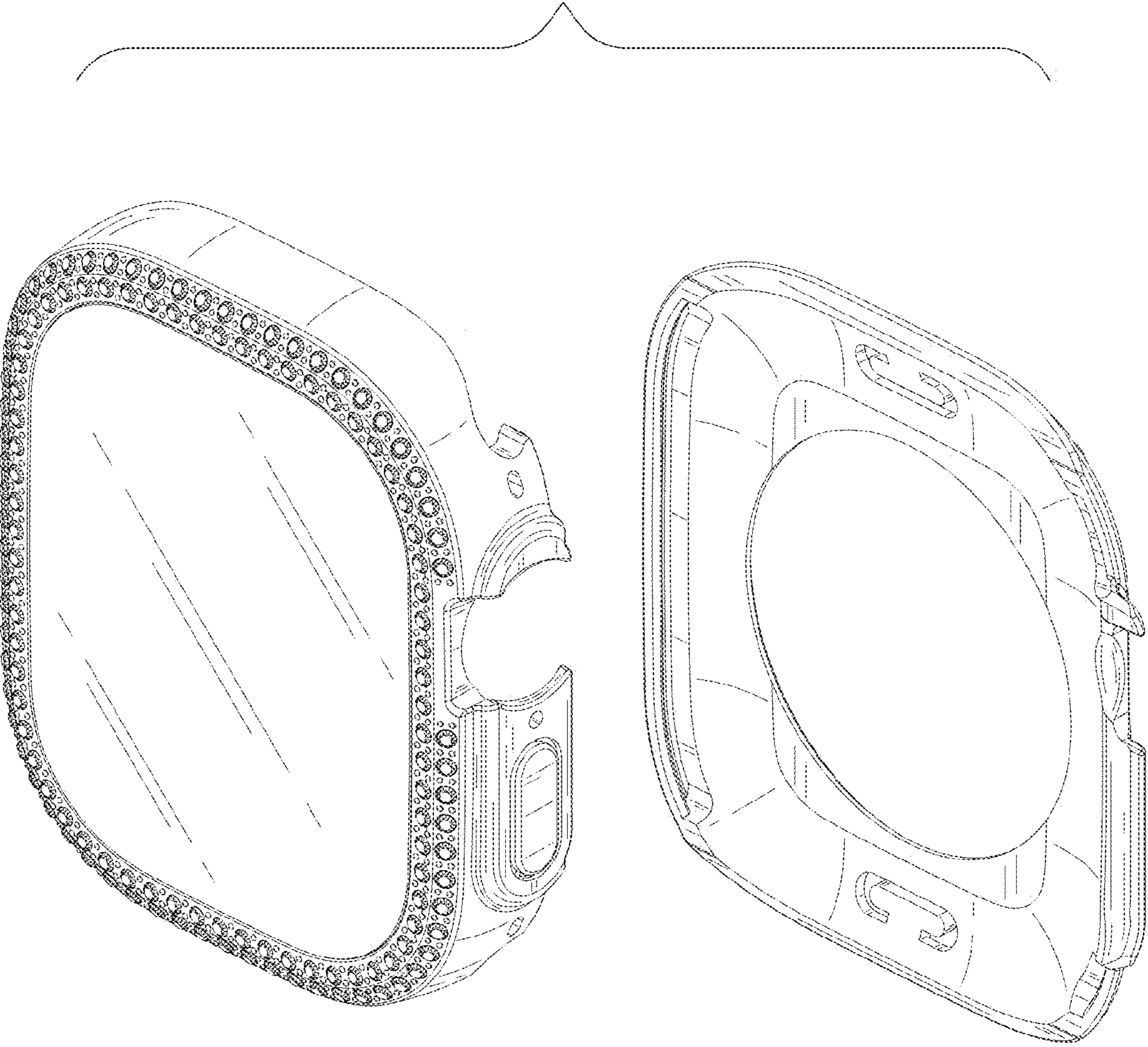

FIG. 22

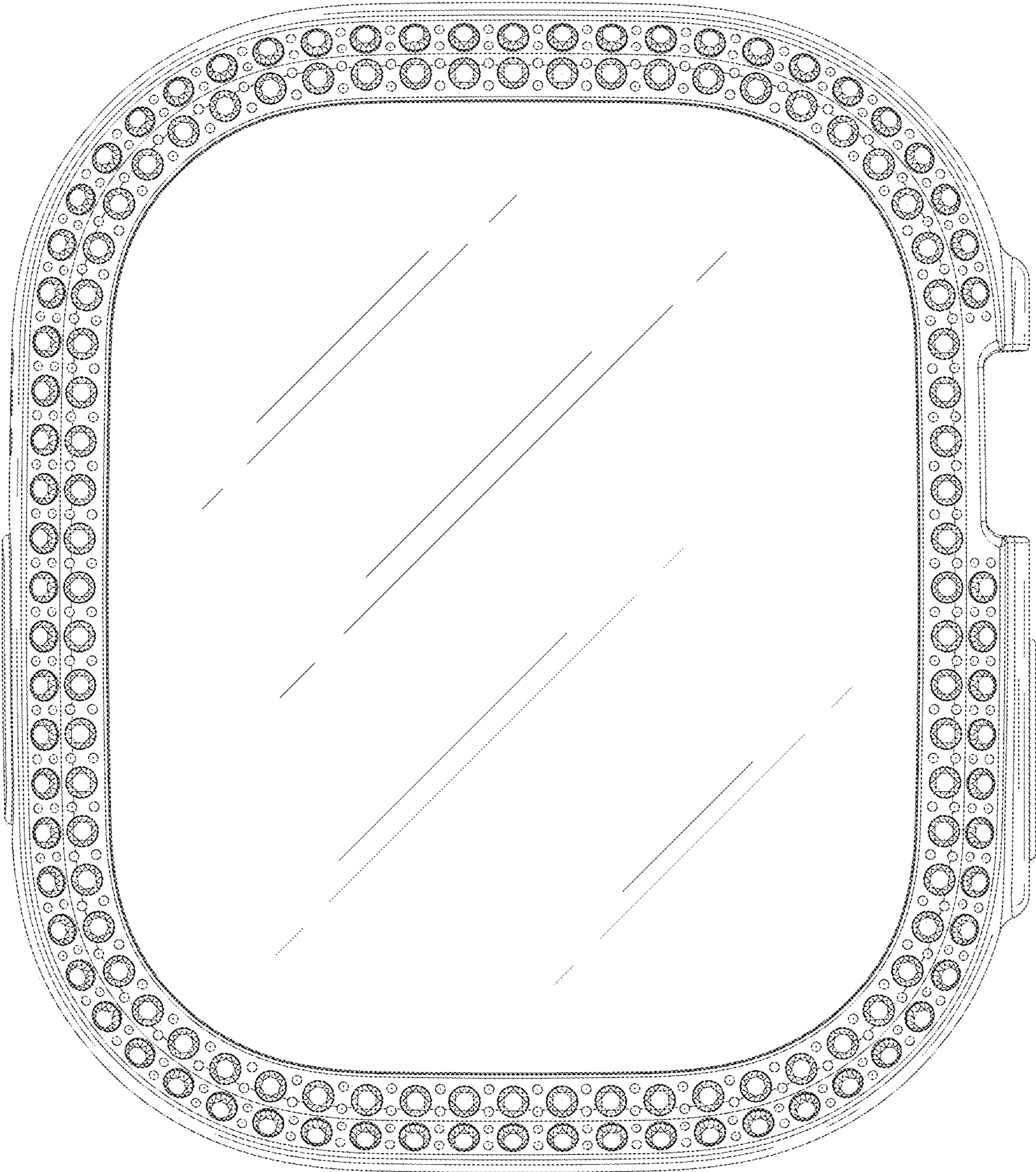

FIG. 23

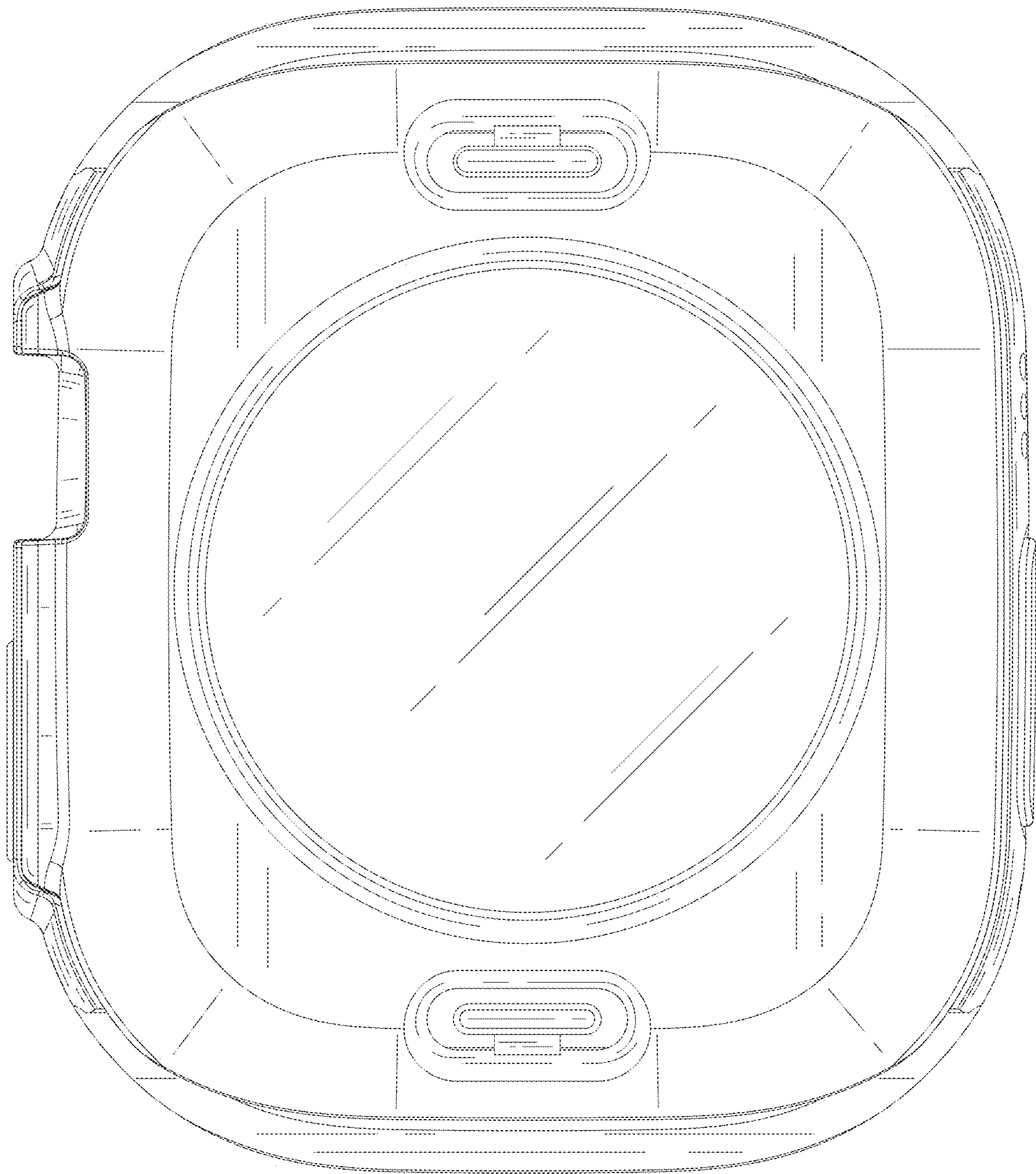

FIG. 24

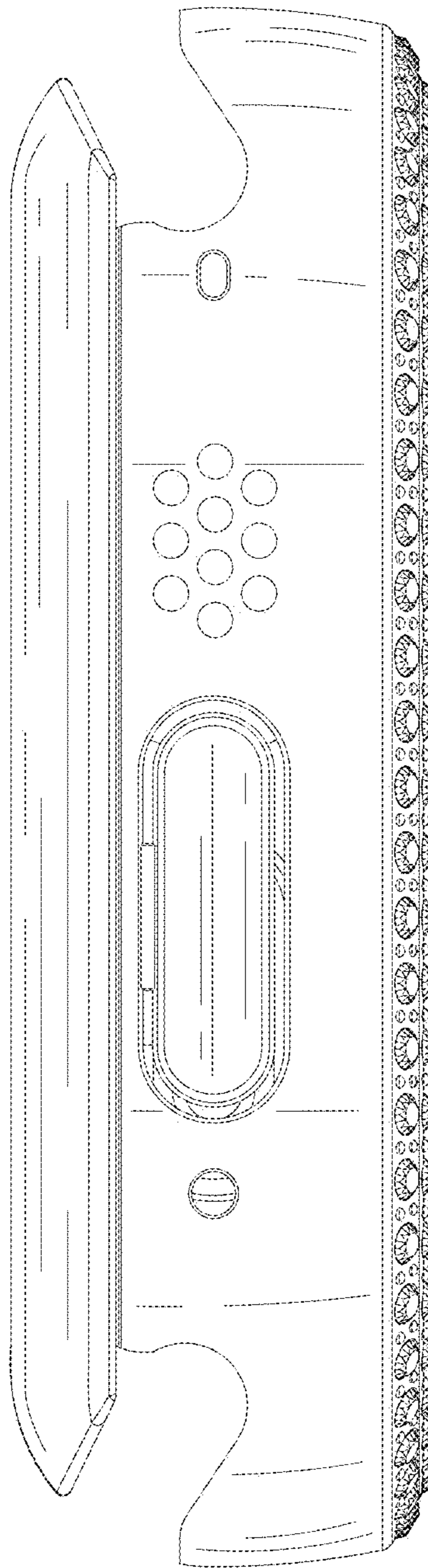

FIG. 25

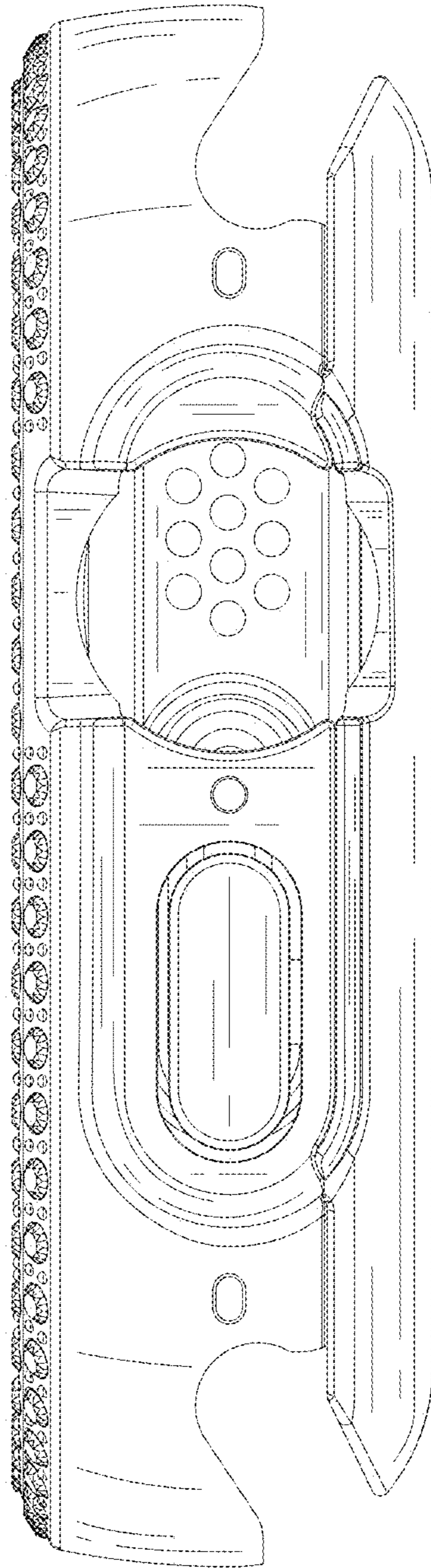

FIG. 26

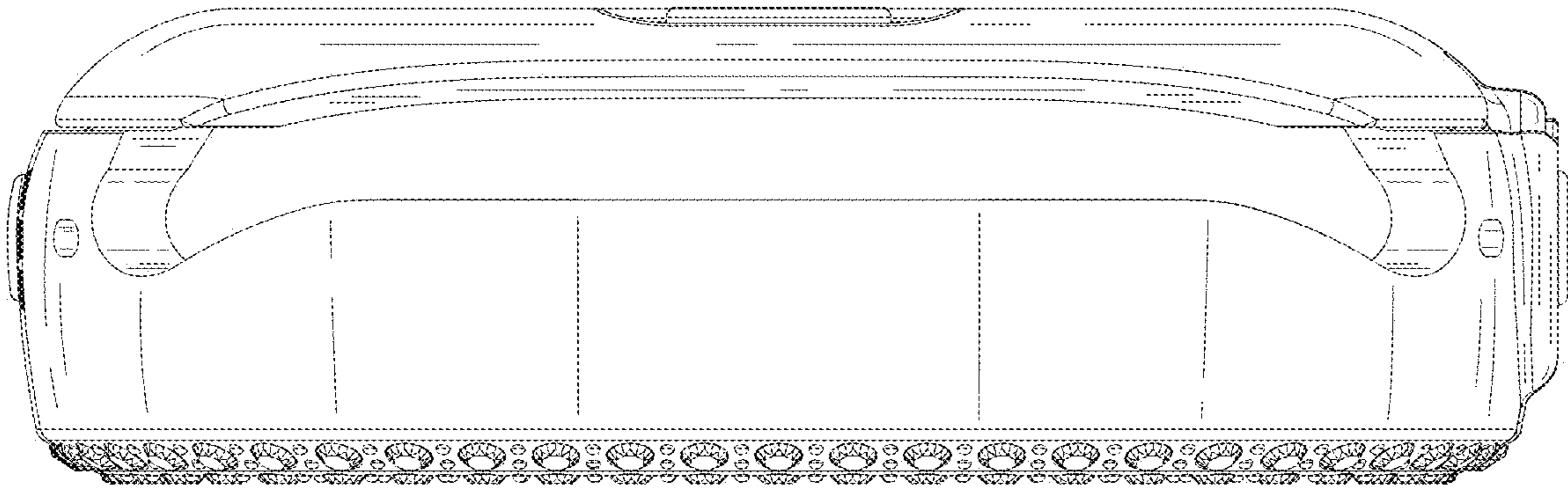

FIG. 27

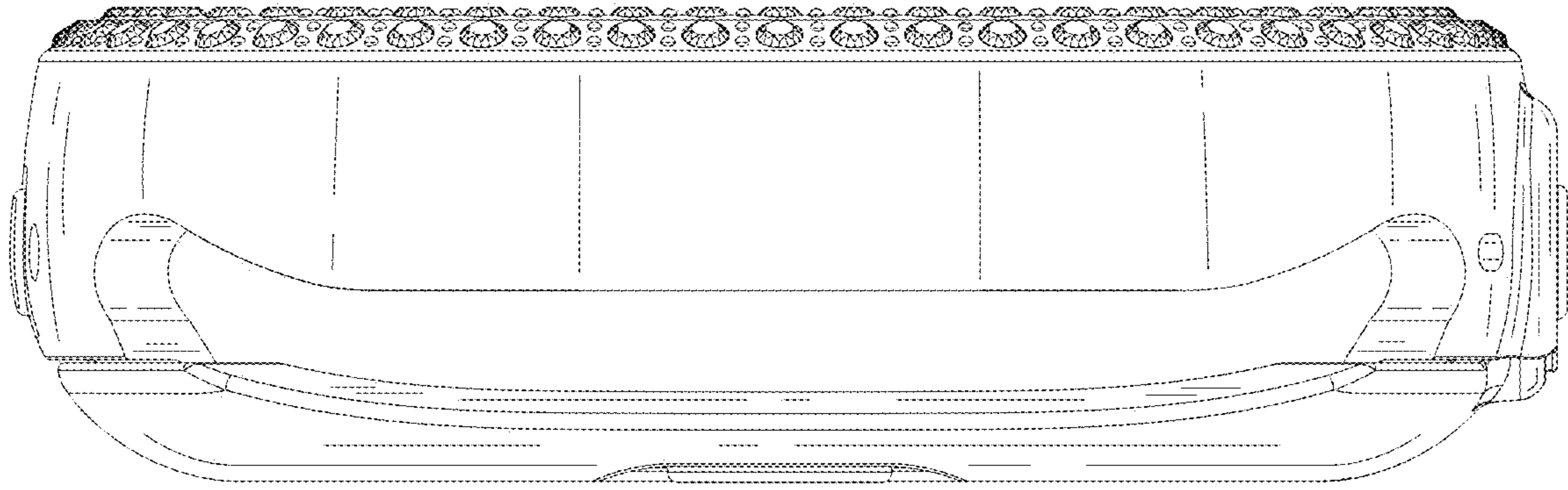

FIG. 28

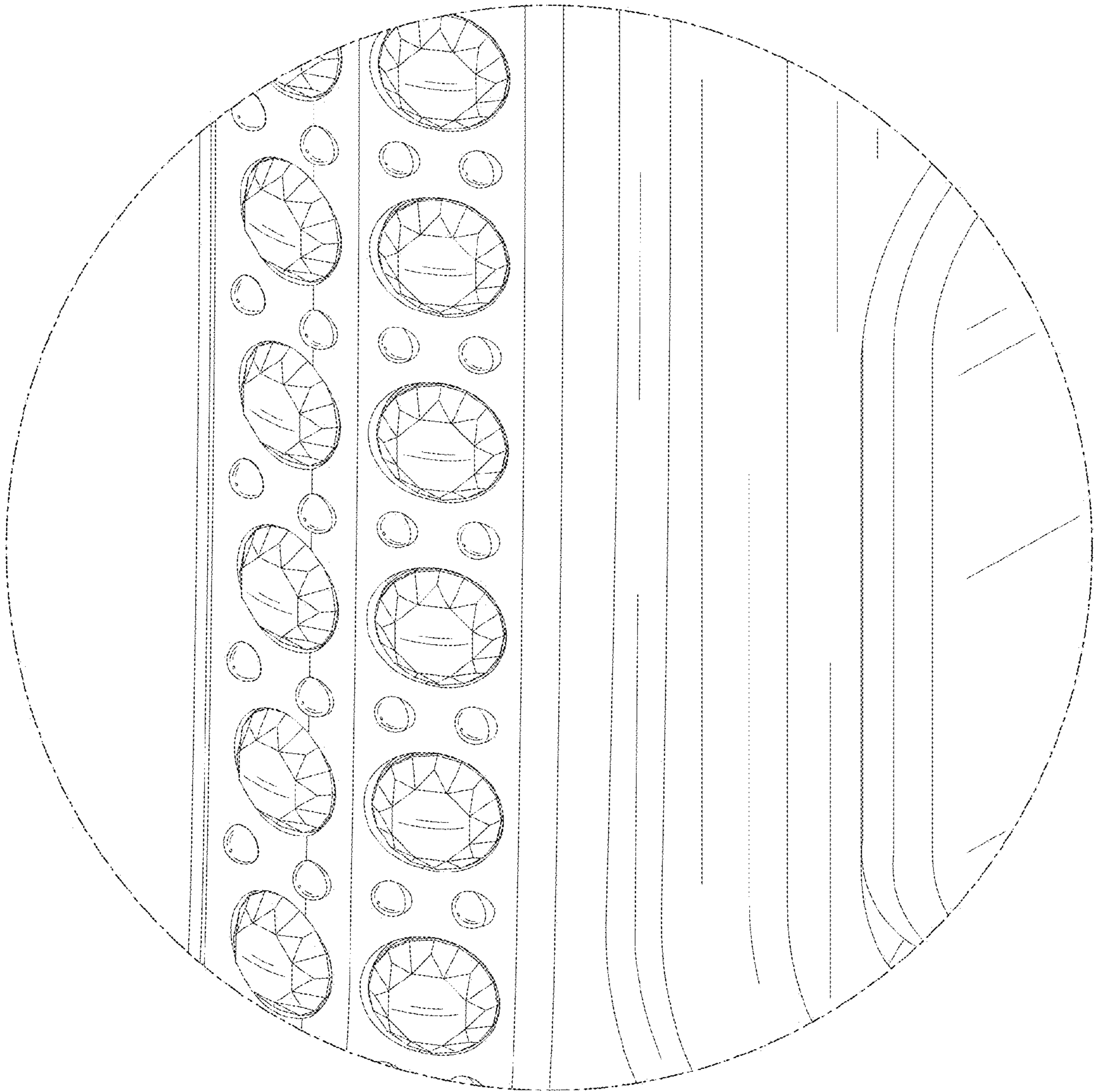

FIG. 29