



US00D985353S

(12) **United States Design Patent** (10) **Patent No.:** **US D985,353 S**
Liu (45) **Date of Patent:** **** May 9, 2023**

(54) **PAPER CUTTER**

(71) Applicant: **Yong Liu, Yiwu (CN)**

(72) Inventor: **Yong Liu, Yiwu (CN)**

(**) Term: **15 Years**

(21) Appl. No.: **29/883,671**

(22) Filed: **Feb. 1, 2023**

(51) **LOC (14) Cl.** **08-03**

(52) **U.S. Cl.**
USPC **D8/98**

(58) **Field of Classification Search**
USPC D8/14, 98; D18/34.3, 34.8, 34.9;
D9/437, 499
CPC B65H 2301/515123; B65H 2301/51532;
B26D 2210/11; B26D 1/045; B26B 29/06
See application file for complete search history.

(56) **References Cited**

U.S. PATENT DOCUMENTS

3,142,426	A *	7/1964	Busse	B65H 35/0086 30/2
3,370,497	A *	2/1968	Busse	B21C 47/34 83/649
5,127,162	A *	7/1992	Mansfield	A22B 5/168 30/294
D481,287	S *	10/2003	Crist	D8/98
D501,386	S *	2/2005	Diaz	B26B 5/00 D8/98
D742,715	S *	11/2015	Krause	D8/98
D890,591	S *	7/2020	Lei	D8/98
D891,217	S *	7/2020	Latham	D32/42
D915,507	S *	4/2021	Cran	D18/34.9
D968,190	S *	11/2022	Tang	D8/98
2004/0216574	A1 *	11/2004	Chabansky	B26B 29/02 83/574

2005/0066787	A1 *	3/2005	Mori	B26D 1/045 83/452
2005/0166738	A1 *	8/2005	Hsu	B26D 7/015 83/649
2008/0271582	A1 *	11/2008	Chabansky	B26D 1/045 83/563
2009/0293695	A1 *	12/2009	Sacchetta	B65H 35/002 83/649
2010/0101098	A1 *	4/2010	Hsu	B26D 1/185 30/319
2017/0217037	A1 *	8/2017	Ferrer	B65H 35/06
2017/0274548	A1 *	9/2017	Persson	E06B 9/40
2018/0345516	A1 *	12/2018	Perla	B26D 1/045
2021/0299899	A1 *	9/2021	Ito	B26D 1/045

* cited by examiner

Primary Examiner — S. Bryan Reinholdt, Jr.

Assistant Examiner — Ieisha N Price

(74) *Attorney, Agent, or Firm* — Justin Lampel

(57) **CLAIM**

The ornamental design for a paper cutter, as shown and described.

DESCRIPTION

FIG. 1 is a bottom perspective view of a paper cutter showing the claimed design;
FIG. 2 is a top perspective view thereof;
FIG. 3 is a front elevational view thereof;
FIG. 4 is a rear elevational view thereof;
FIG. 5 is a left side elevational view thereof;
FIG. 6 is a right side elevational view thereof;
FIG. 7 is a top plan view thereof; and,
FIG. 8 is a bottom plan view thereof.
The broken lines in the drawings depict portions of the paper cutter and form no part of the claimed design.

1 Claim, 8 Drawing Sheets

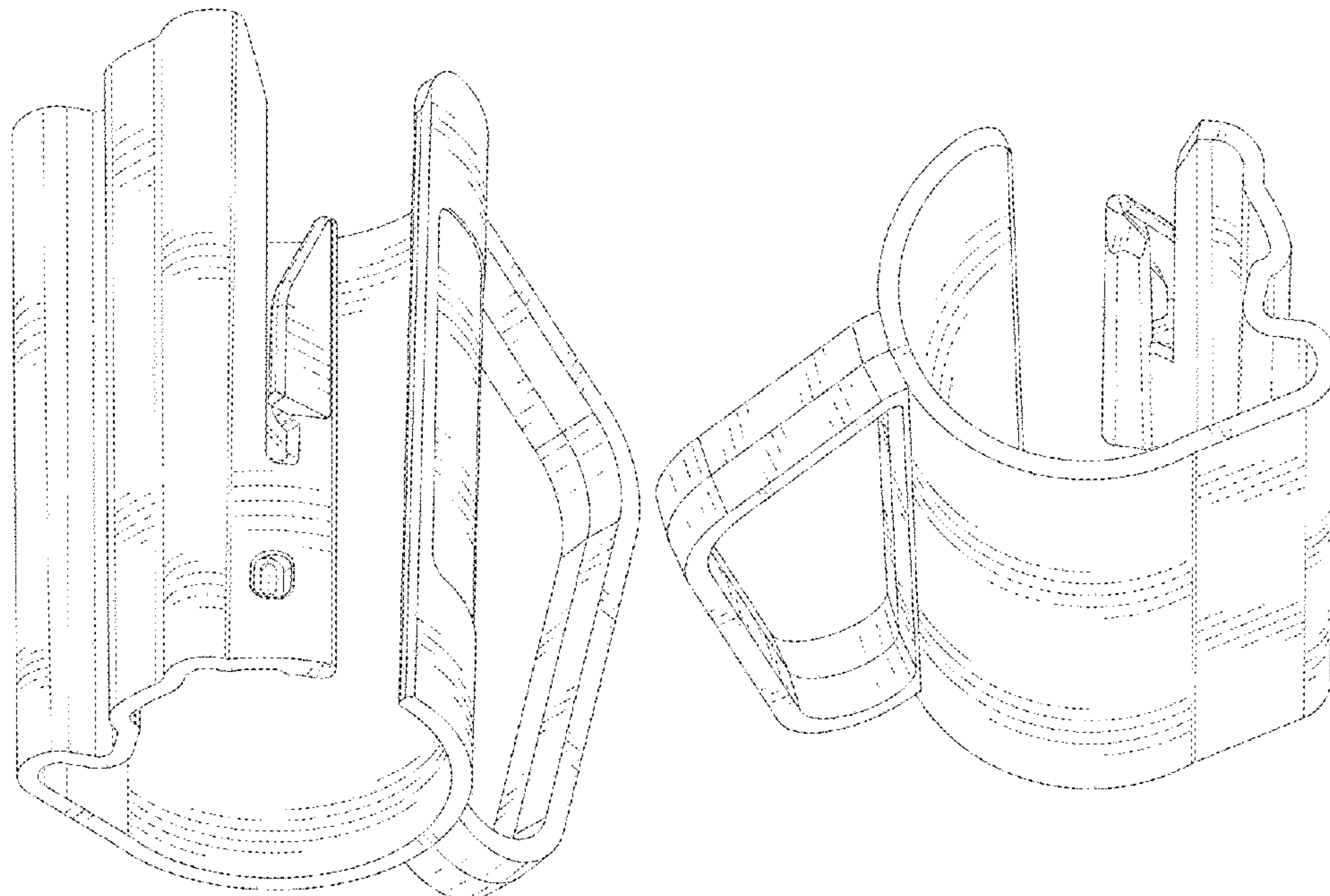

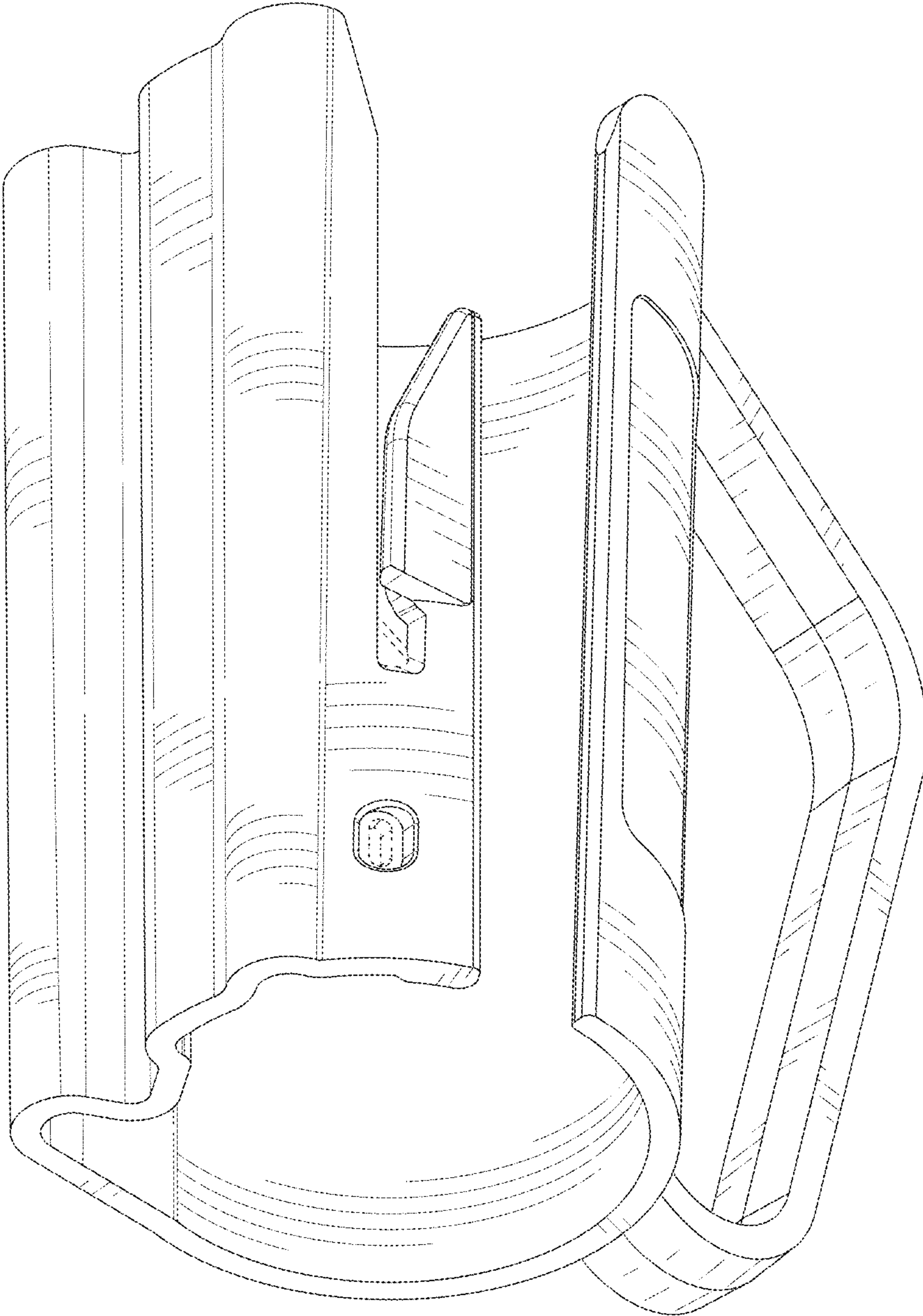

FIG. 1

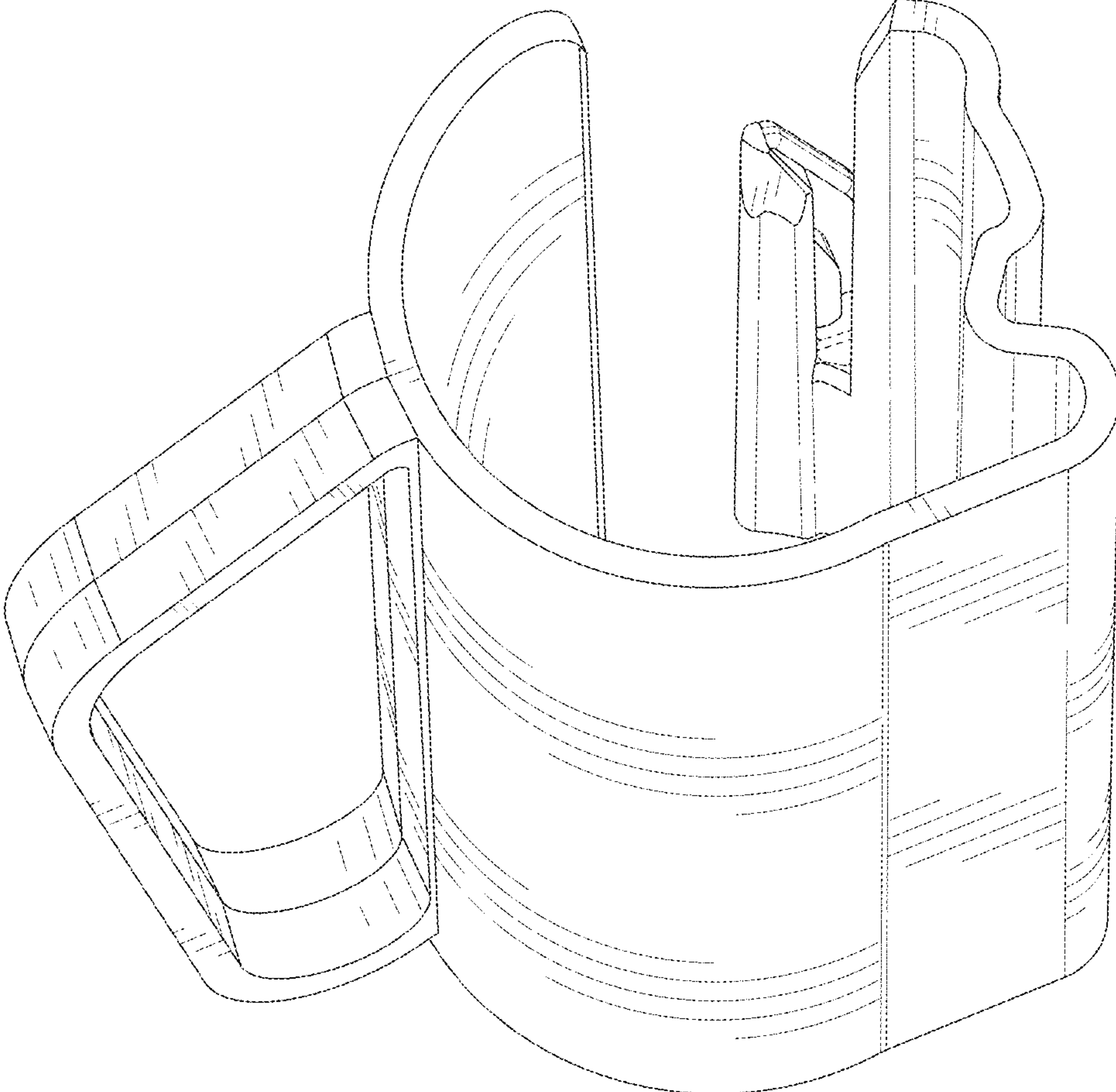

FIG. 2

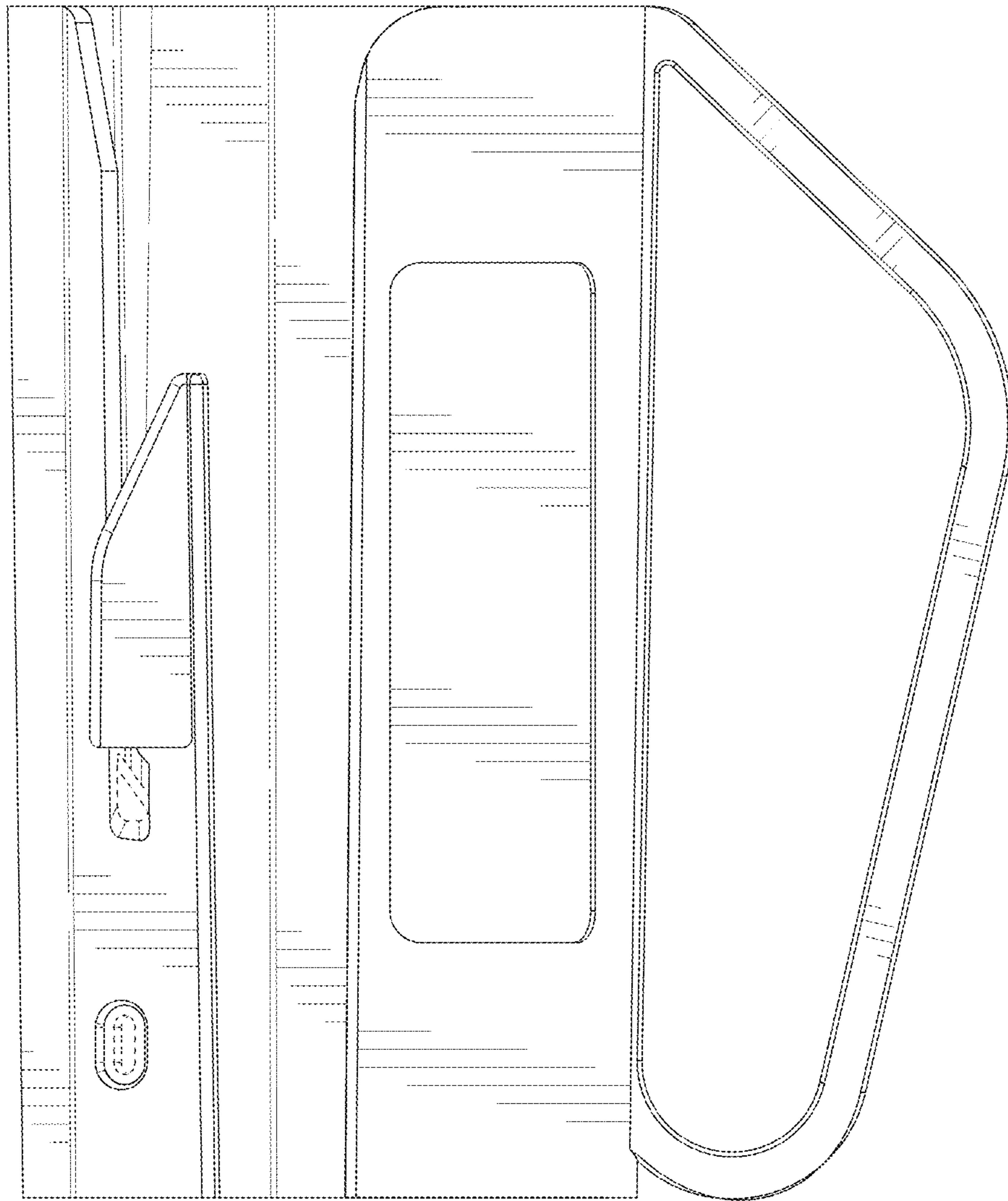

FIG. 3

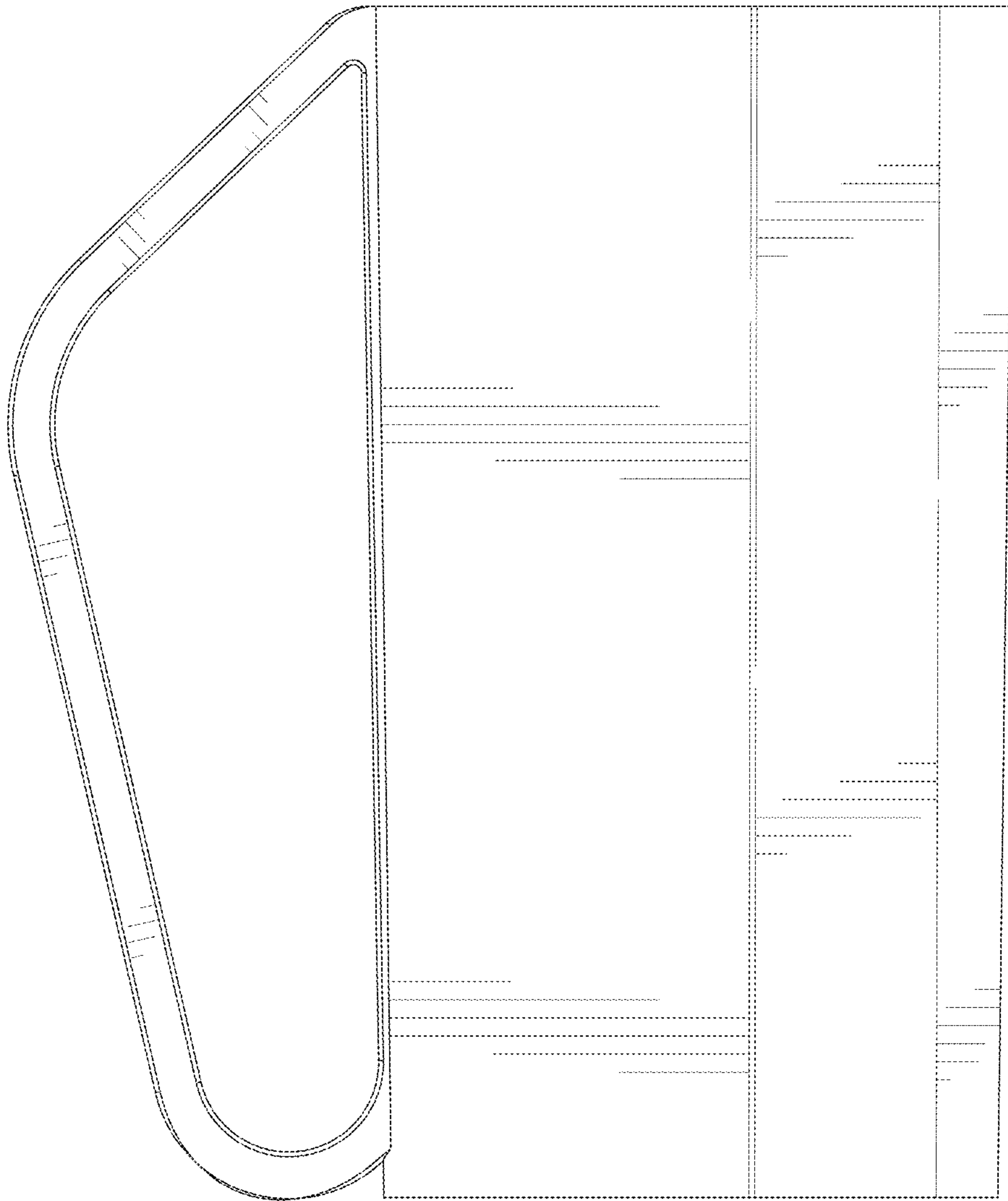

FIG. 4

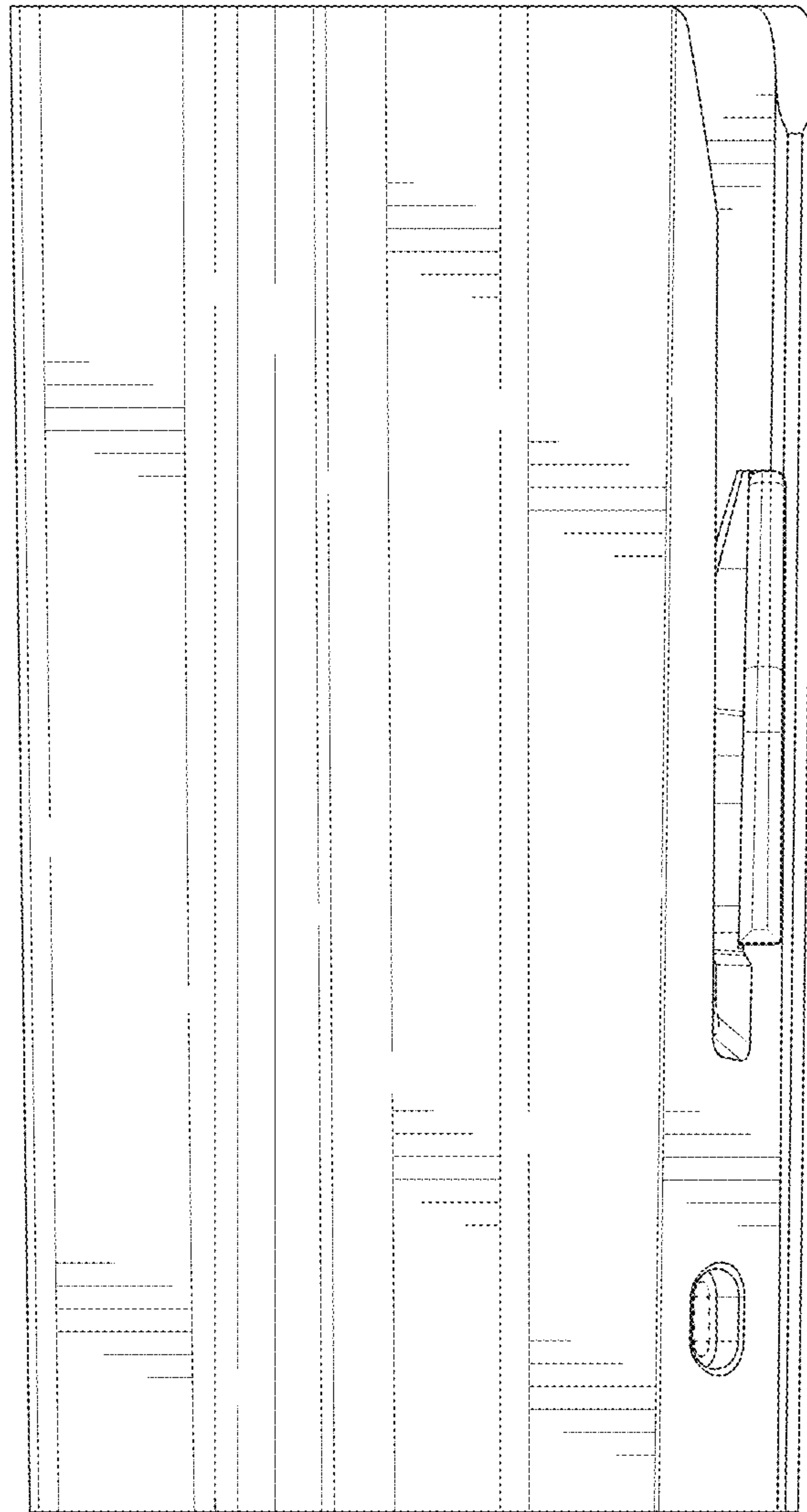

FIG. 5

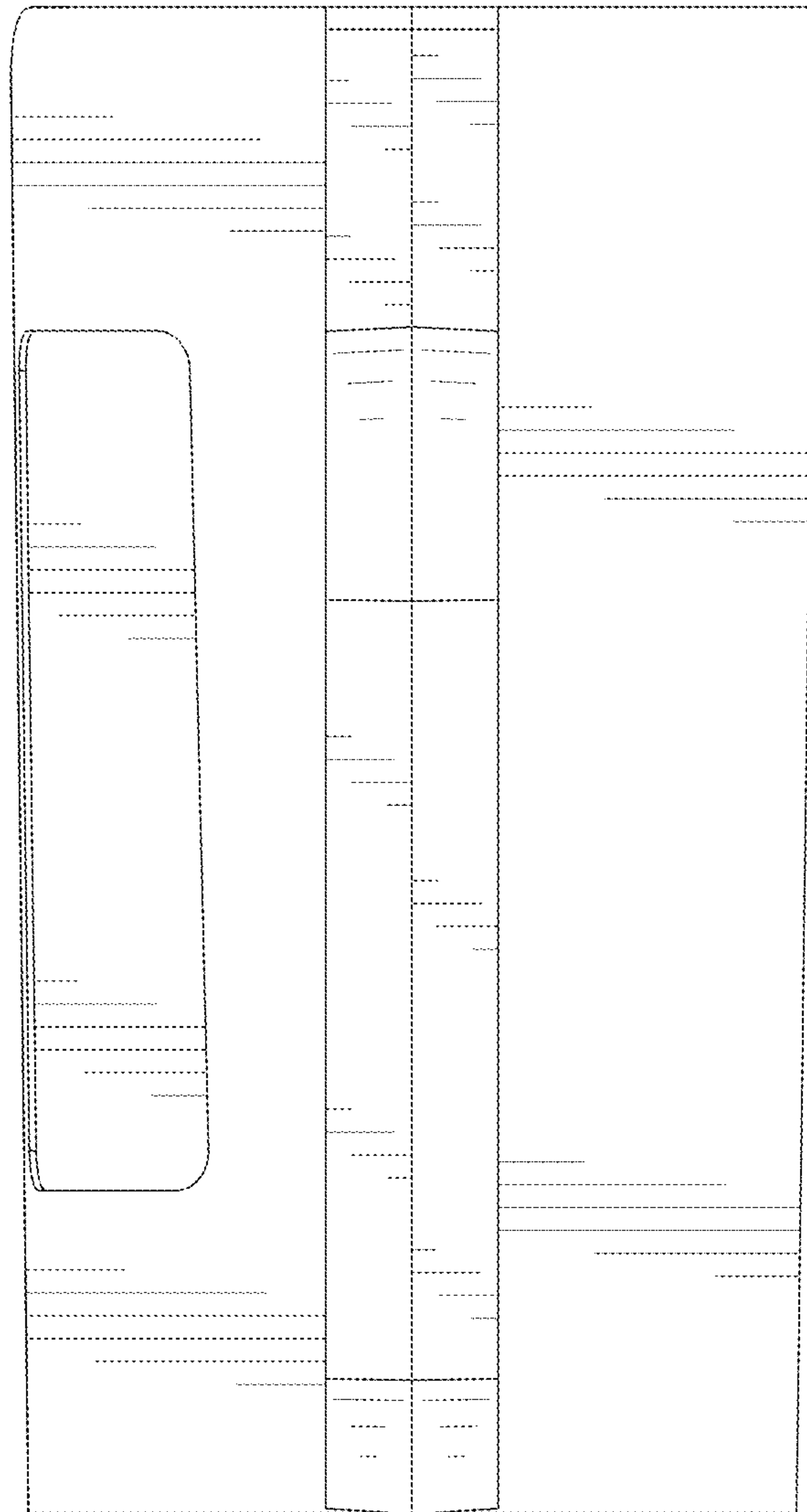

FIG. 6

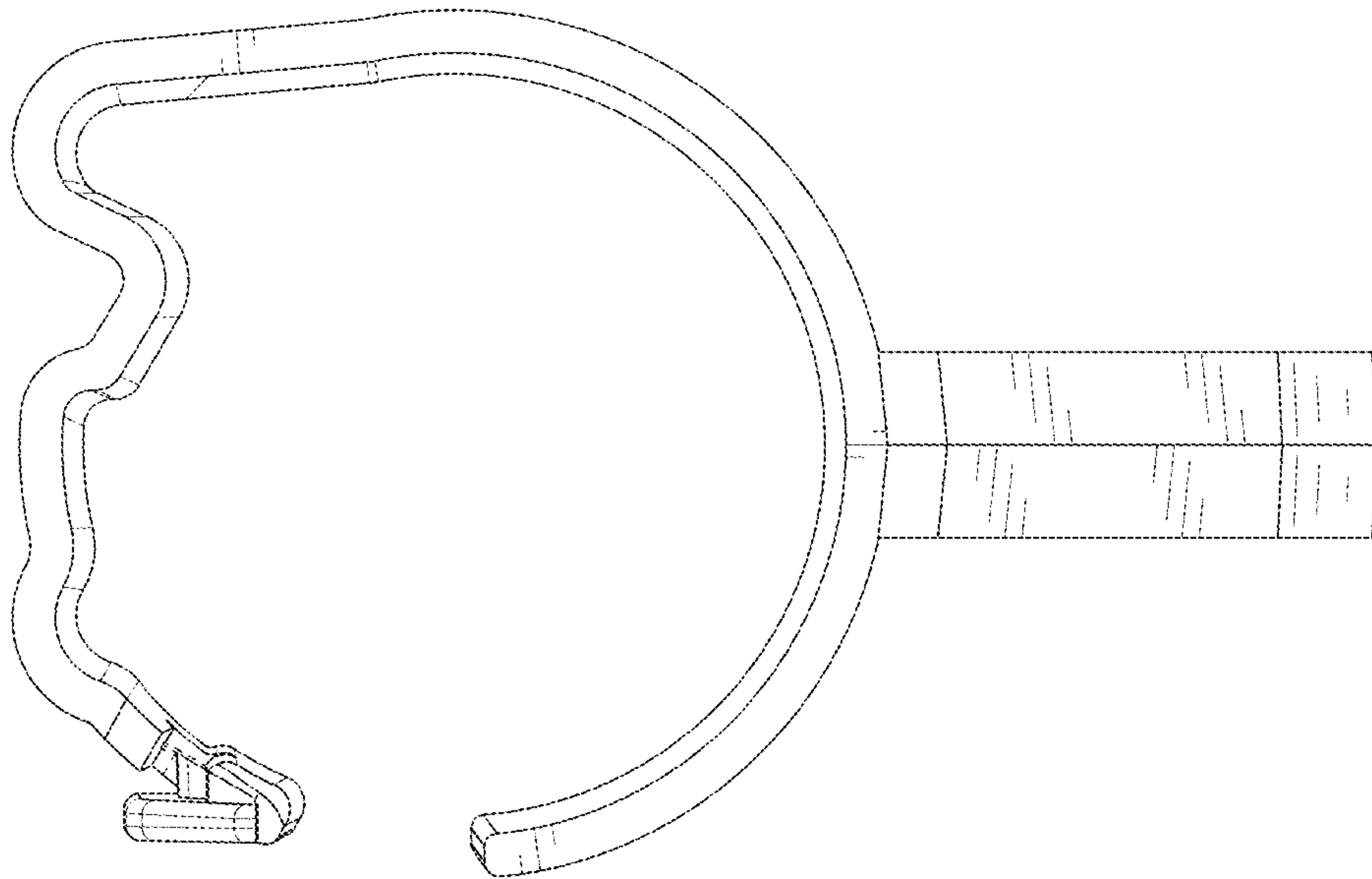

FIG. 7

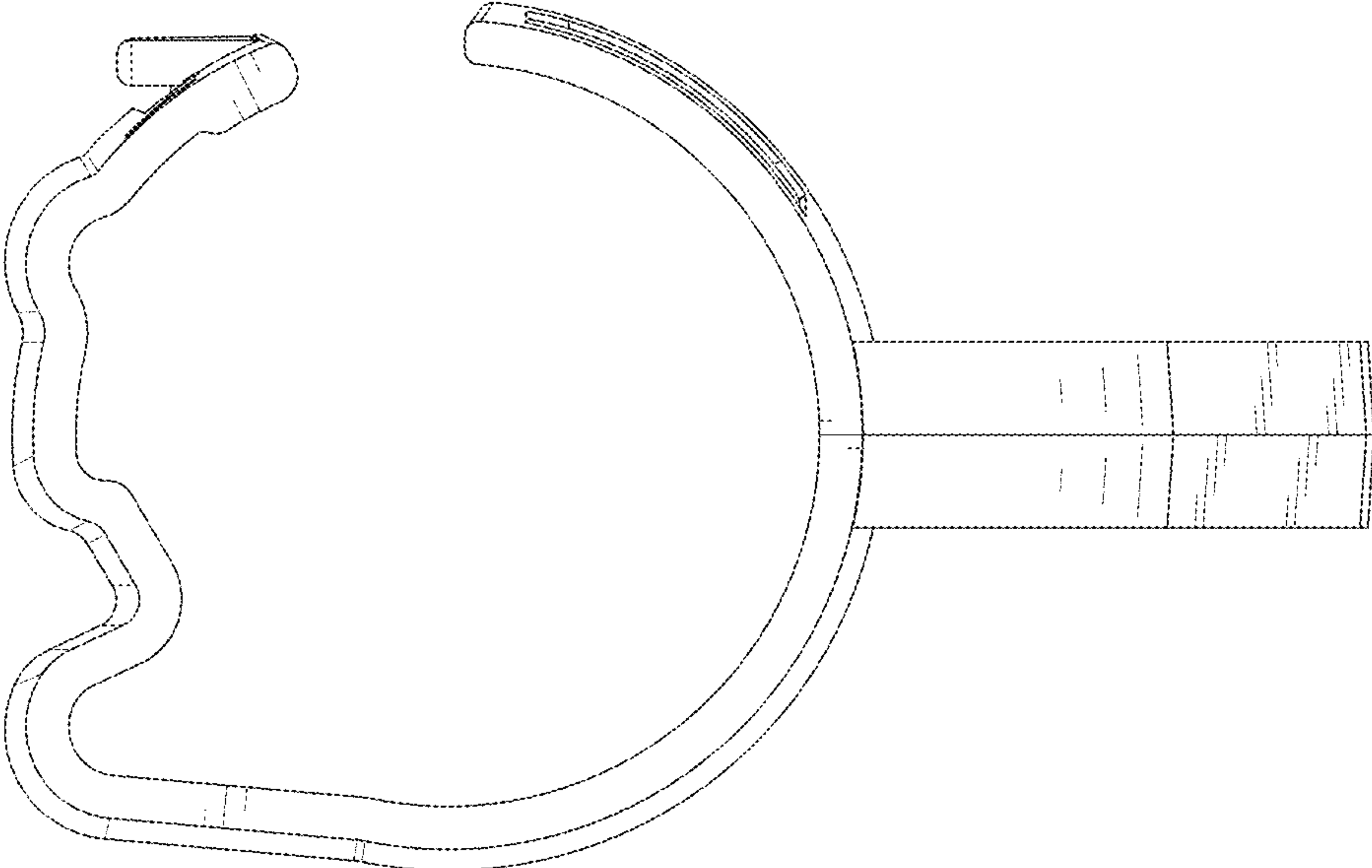

FIG. 8