



US00D985311S

(12) **United States Design Patent** (10) **Patent No.:** **US D985,311 S**
Marshall (45) **Date of Patent:** **** May 9, 2023**

(54) **SUPPORTIVE PILLOW**

FOREIGN PATENT DOCUMENTS

(71) Applicant: **Teresa C. Marshall**, Cincinnati, OH
(US)

CN 303392341 * 9/2015
CN 303786543 * 8/2016

(Continued)

(72) Inventor: **Teresa C. Marshall**, Cincinnati, OH
(US)

OTHER PUBLICATIONS

(**) Term: **15 Years**

Google search: "supportive pillow" [site visited Jan. 12, 2023]
<URL: https://www.google.com/search?q=supportive+pillow&sxsrf=ALeKk02tM9TMoUMEHj2Jk5xdqcn60G1dzQ:1624059903153&source=lnms&tbn=isch&sa=X&ved=2ahUKEwjAzfvMrqLxAhVNGVkfFHUGBCD_oQ_AUoAnoECAUQBA&biw=1200&bih=1777> (Year: 2021).*

(21) Appl. No.: **29/819,666**

(22) Filed: **Dec. 16, 2021**

(Continued)

Related U.S. Application Data

(63) Continuation-in-part of application No. 29/770,478,
filed on Feb. 12, 2021, now Pat. No. Des. 942,183.

Primary Examiner — Sanjeev Paul

(51) **LOC (14) Cl.** **06-09**

(74) *Attorney, Agent, or Firm* — Bold IP, PLLC; Houda El-Jarrah

(52) **U.S. Cl.**

USPC **D6/601**

(57) **CLAIM**

(58) **Field of Classification Search**

The ornamental design for a supportive pillow, as shown and as described.

USPC D6/595, 596, 597, 600, 601, 603, 604,
D6/605, 606, 608, 522, 546, 582, 583;
D24/183, 185, 234; D21/803, 804, 805,
D21/809, 439, 440

DESCRIPTION

CPC A47G 2009/1018; A47G 2009/003; A47G
9/0253; A47G 9/10; A47G 9/1027; A47G
9/1036; A47G 9/1054; A47G 9/1063;
A47G 9/1072; A47G 9/1081; A47G
9/109; A45F 4/06; A47C 21/06; A47C
7/18; A47C 20/00; A47C 17/80; A47C
17/82; A47C 17/64; A47C 27/00; A47C
27/14; A47C 23/00; A47C 17/021; A47C
17/13; A47C

FIG. 1 is a left side perspective view of a supportive pillow showing my new design;
FIG. 2 is a left view thereof;
FIG. 3 is a right view thereof;
FIG. 4 is a back view thereof;
FIG. 5 is a front view thereof;
FIG. 6 is a top view thereof;
FIG. 7 is a bottom view thereof; and,
FIG. 8 is another left side perspective view of the supportive pillow in accordance with my new design shown with a person's head laying on the supportive pillow.
The broken lines included in FIG. 8 of the supportive pillow illustrate environmental structure and form no part of the claimed design. The remainder of the broken lines shown in the Figures represent portions of the supportive pillow that form no part of the claimed design.

(Continued)

(56) **References Cited**

U.S. PATENT DOCUMENTS

D222,714 S 12/1971 Bates
6,574,810 B2 6/2003 Mangiaracina

(Continued)

1 Claim, 6 Drawing Sheets

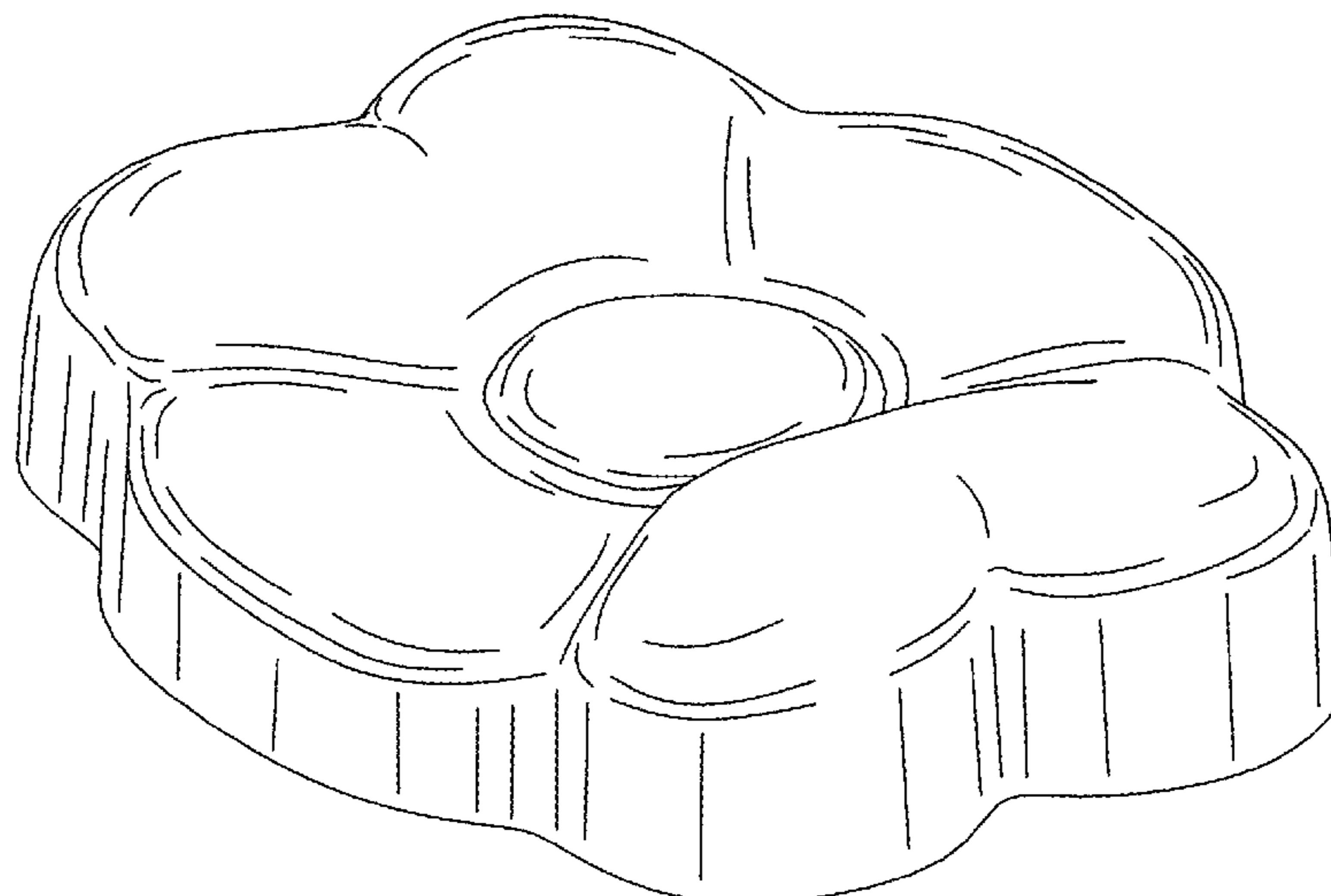

(58) **Field of Classification Search**

CPC . 17/132; A47C 17/136; A47C 17/1655; A47C 17/207

See application file for complete search history.

FOREIGN PATENT DOCUMENTS

CN	306884418	* 10/2021
CN	307039426	* 12/2021
CN	307289577	* 4/2022
WO	D067332-004	* 2/2006

(56) **References Cited**

U.S. PATENT DOCUMENTS

D510,400	S	*	10/2005	Rockstad	D6/601
D533,006	S	*	12/2006	Boutin	D21/628
D553,893	S	*	10/2007	Boutin	D6/601
D597,364	S		8/2009	Lindgren		
D607,176	S	*	1/2010	Roskam	D1/115
D639,100	S	*	6/2011	Heroux	D6/601
D645,686	S	*	9/2011	Heroux	D6/601
D645,687	S	*	9/2011	Heroux	D6/601
D645,688	S	*	9/2011	Heroux	D6/601
D645,689	S	*	9/2011	Heroux	D6/601
D645,690	S	*	9/2011	Heroux	D6/601
D645,691	S	*	9/2011	Heroux	D6/601
D645,692	S	*	9/2011	Heroux	D6/601
D712,681	S	*	9/2014	Del Russo, Jr.	D6/600
D727,661	S		4/2015	Blumenthal		
D731,813	S		6/2015	Durkin		
D751,322	S		3/2016	Reynolds		
D784,729	S	*	4/2017	Lee	D6/563
D790,880	S		7/2017	Wong et al.		
D856,709	S	*	8/2019	Ng	D6/601
D856,710	S	*	8/2019	Ng	D6/601
D881,608	S	*	4/2020	Fu	D6/601
D882,294	S	*	4/2020	Tang	D6/583
D887,175	S		6/2020	Loos		
D898,418	S	*	10/2020	Fu	D6/600
D899,137	S	*	10/2020	Pond	D6/597
D899,811	S	*	10/2020	Fu	D6/600
10,813,821	B2		10/2020	Marinkovic		
D918,624	S	*	5/2021	Weitzman	D6/601
D942,183	S	*	2/2022	Marshall	D6/601
D954,469	S	*	6/2022	Fu	D6/600
D954,470	S	*	6/2022	Wu	D6/600
D960,608	S	*	8/2022	Xue	D6/600
2013/0113262	A1		5/2013	Nam		

OTHER PUBLICATIONS

Arelux Colorful Flower shaped pillow, earliest pictured review date Nov. 8, 2020, [online], [site visited Jan. 13, 2023]. Available from Internet, <URL: https://www.amazon.com/ARELUX-Colorful-Flower-Seating-Cushion/dp/B08D3MLQVV/ref=pd_lpo_2?pd_rd_i=B08D3MLQVV&psc=1> (Year: 2020).*

“Remedy Microbead Pillow,” <https://www.amazon.com/Remedy-64-879063-Microbead-Pillow/dp/B00FPHLWVO> [Date Accessed: Oct. 29, 2020].

“Girls Flower Floor Pillow Seating Cushion, for a Reading Nook, Bed Room, or Watching TV. Softer and More Plush Than Area Rug or Foam Mat,” https://www.amazon.com/Flower-Seating-Cushion-Reading-Watching/dp/B007496MUM/ref=asc_df_B007496MUM/?tag=hyprod-20&linkCode=df0&hvadid=191963809899&hvpos=&hvnetw=g&hvrnd=1451396725874198938&hvpone=&hvptwo=&hvqmt=&hvdev=c&hvdvcmdl=&hvlocint=&hvlocphy=9033257&hvtargid=pla-303786494355&psc=11 [Date Nov. 20, 2019].

Google search: “supportive pillow” [site visited Jun. 18, 2021]: https://www.google.com/search?q=supportive+pillow&sxsrf=ALeKk02tM9TMoUMEHj2Jk5xdqcn60G1dzQ:1624059903153&source=lnms&tbm=isch&sa=X&ved=2ahUKEwjAzfvMrqLxAhVNGVvKFHUGBCDoQ_AUoAnoECAUQBA&biw=1200&bih=1777 (Year: 2021).

Arelux Colorful Flower shaped pillow, earliest pictured review date Nov. 8, 2020, [online], [site visited Jun. 18, 2020]. Available from Internet, <URL: https://www.amazon.com/ARELUX-Colorful-Flower-Seating-Cushion/dp/B08D3MLQVV/ref=pd_1_po_2?pd_rd_i=B08D3MLQVV&psc=1> (Year: 2020).

* cited by examiner

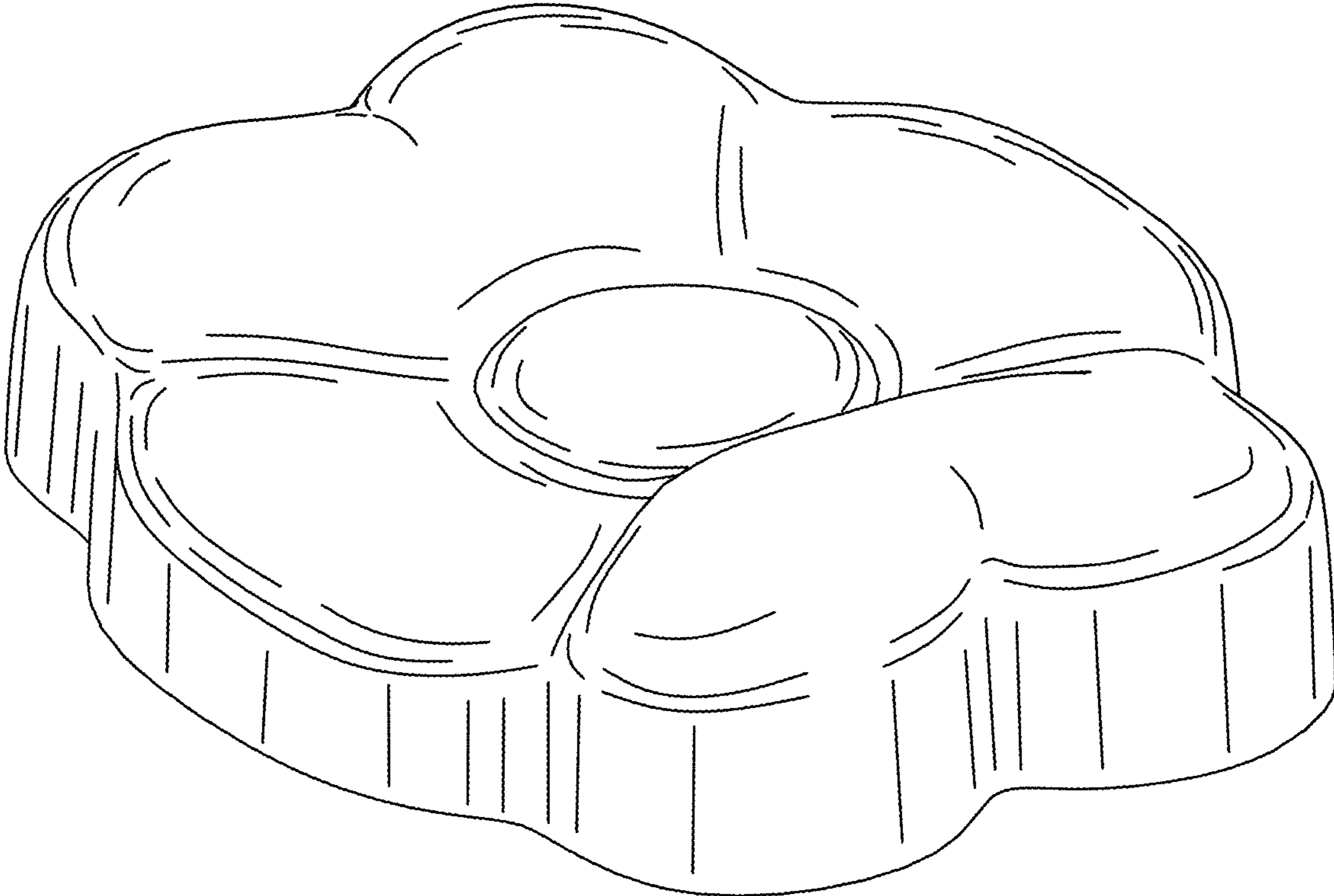

FIG. 1

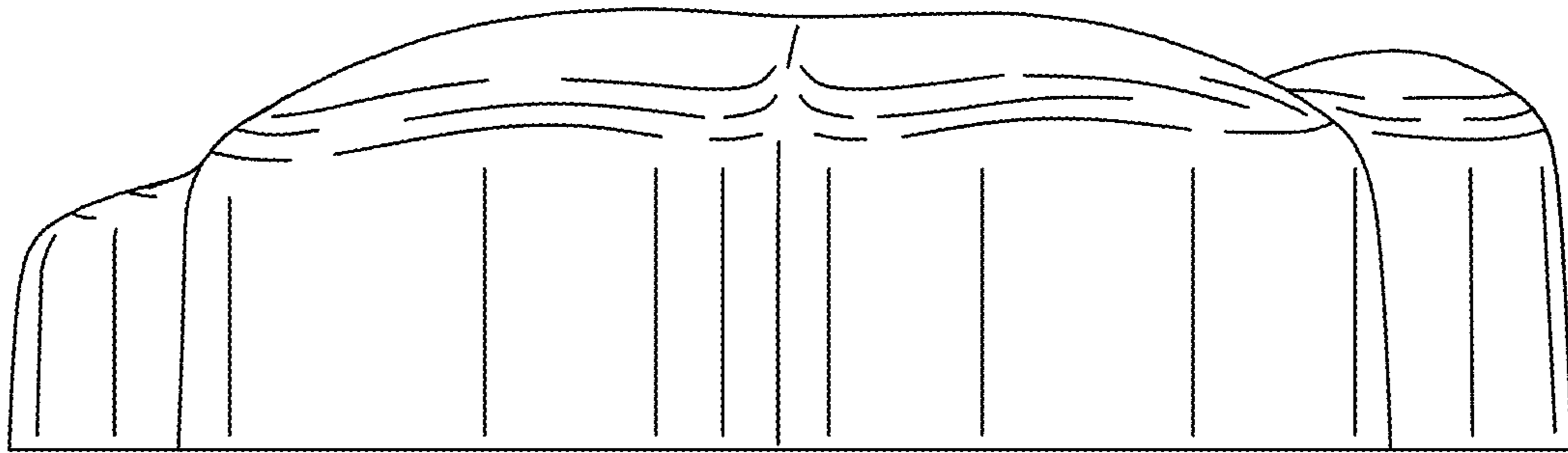

FIG. 2

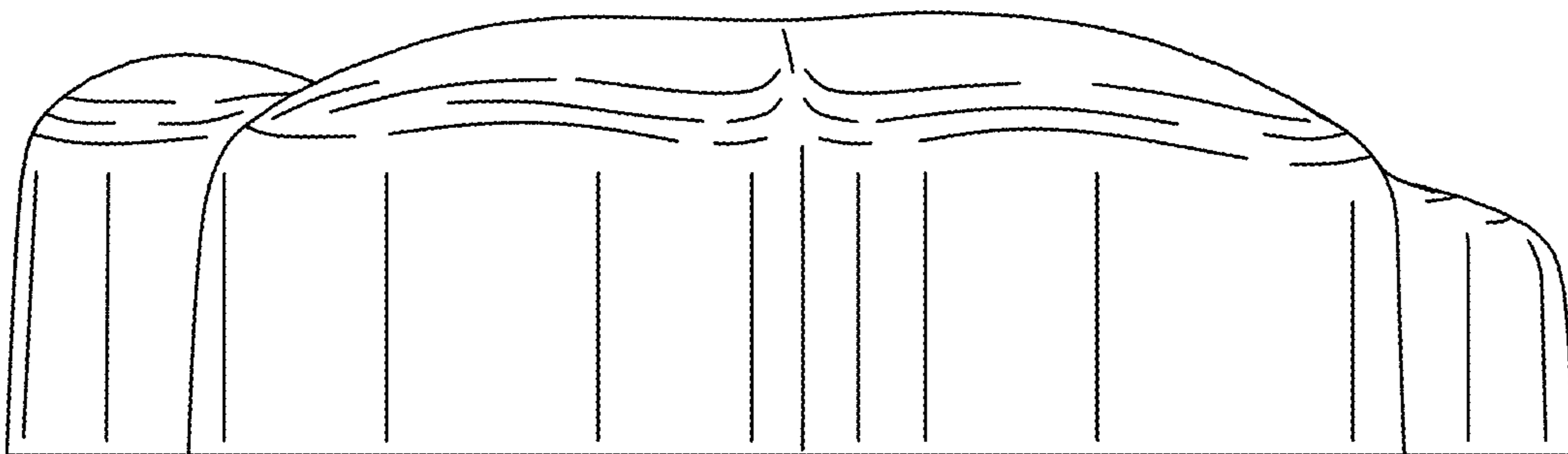

FIG. 3

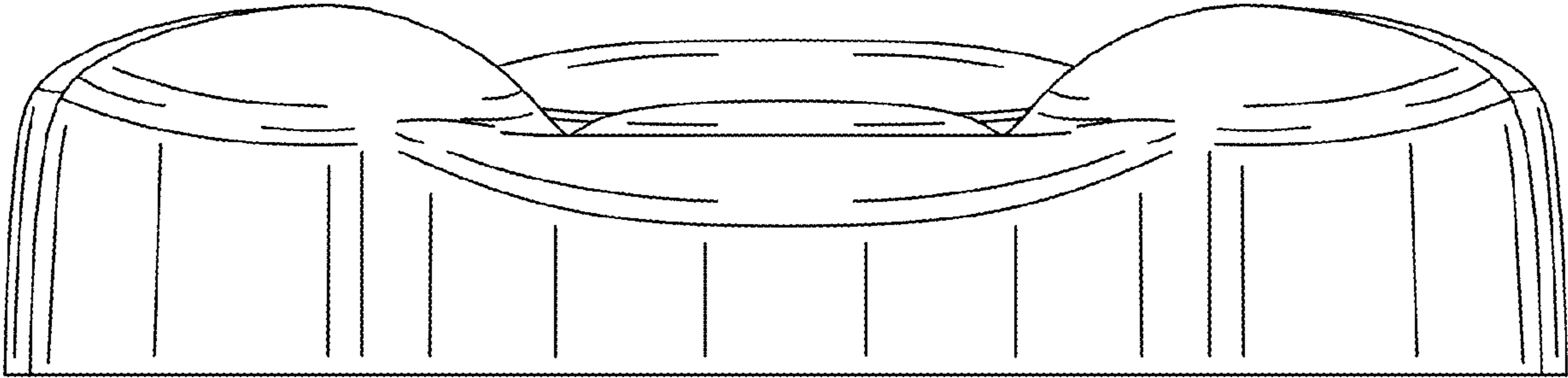

FIG. 4

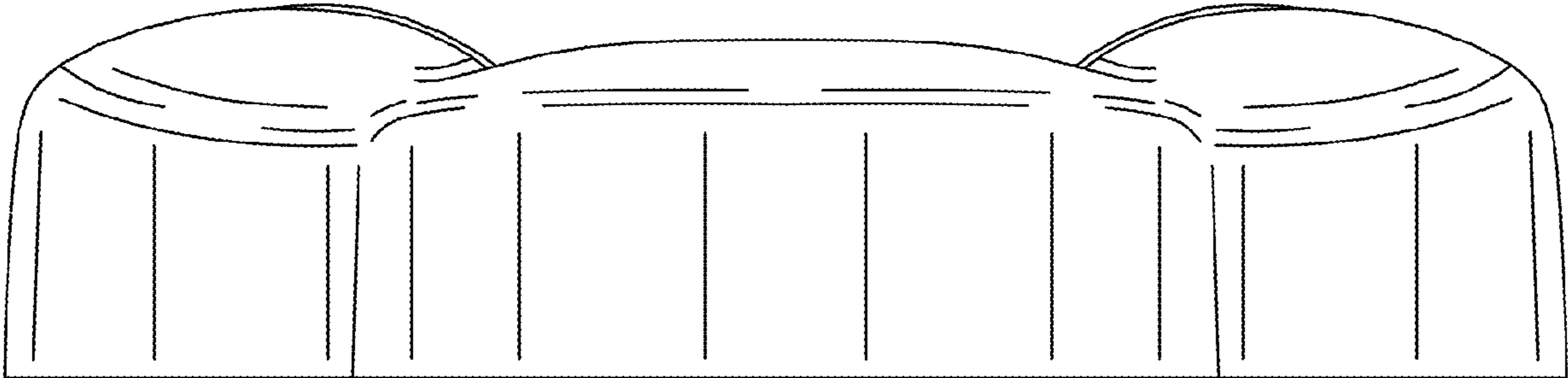

FIG. 5

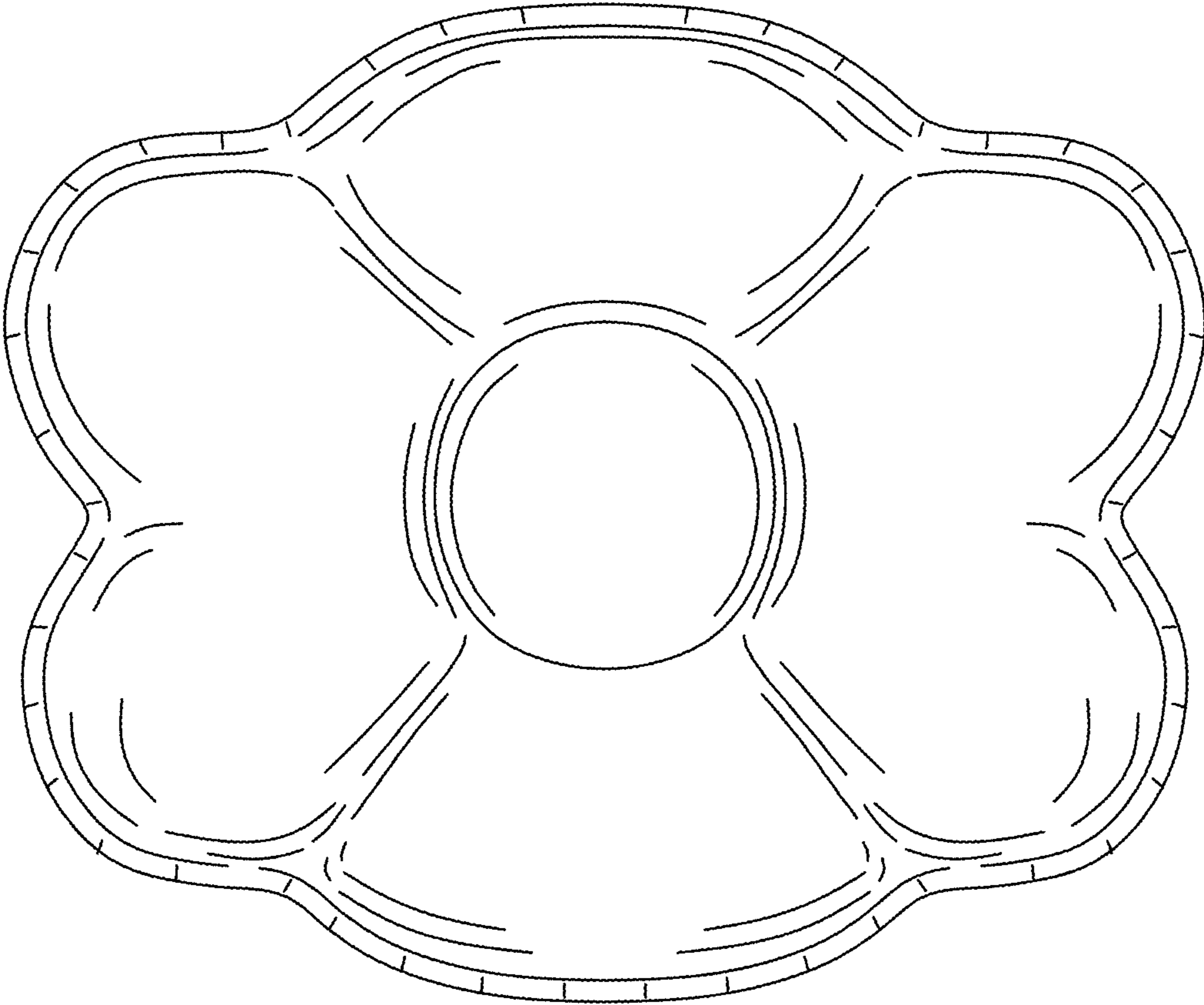

FIG. 6

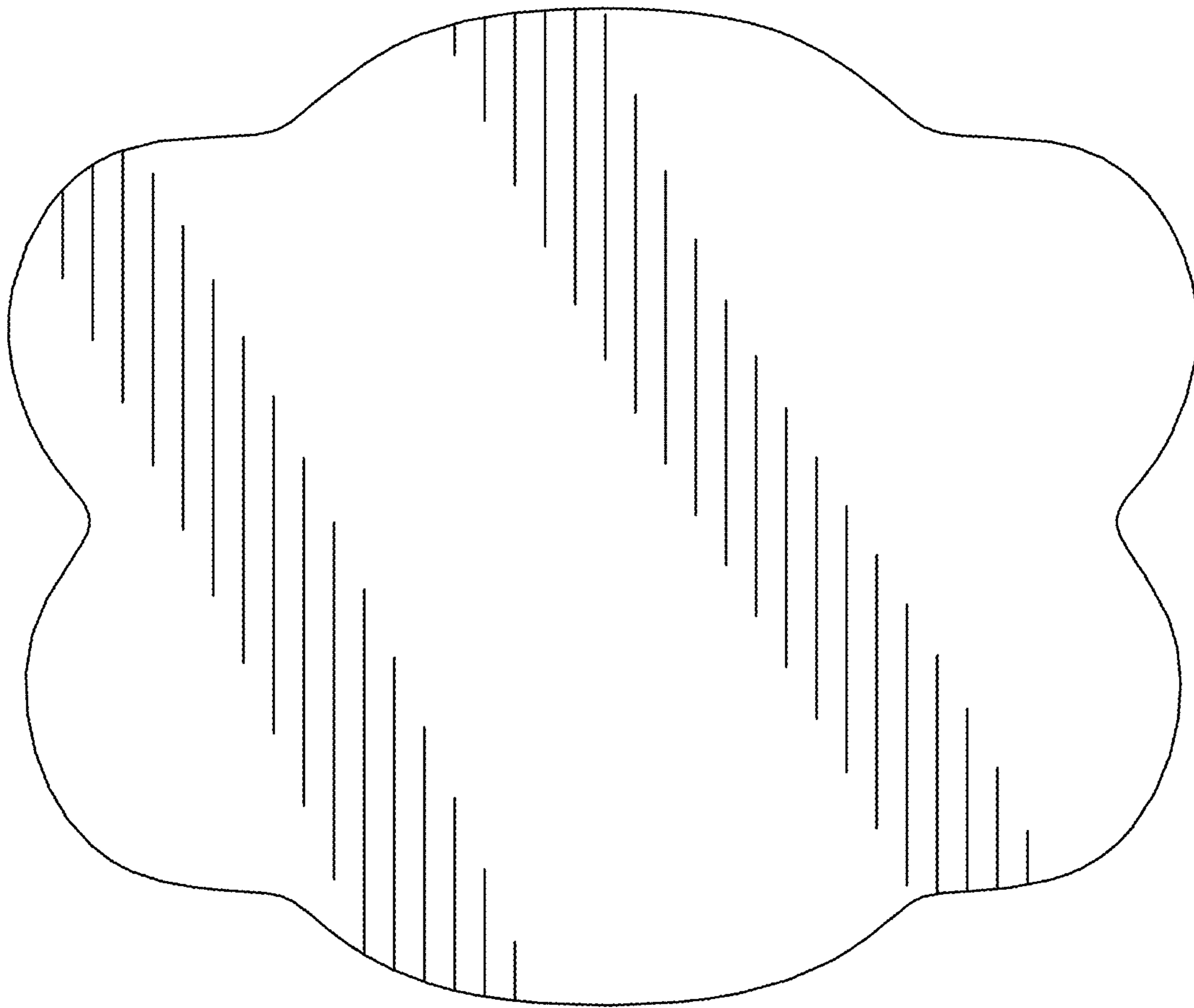

FIG. 7

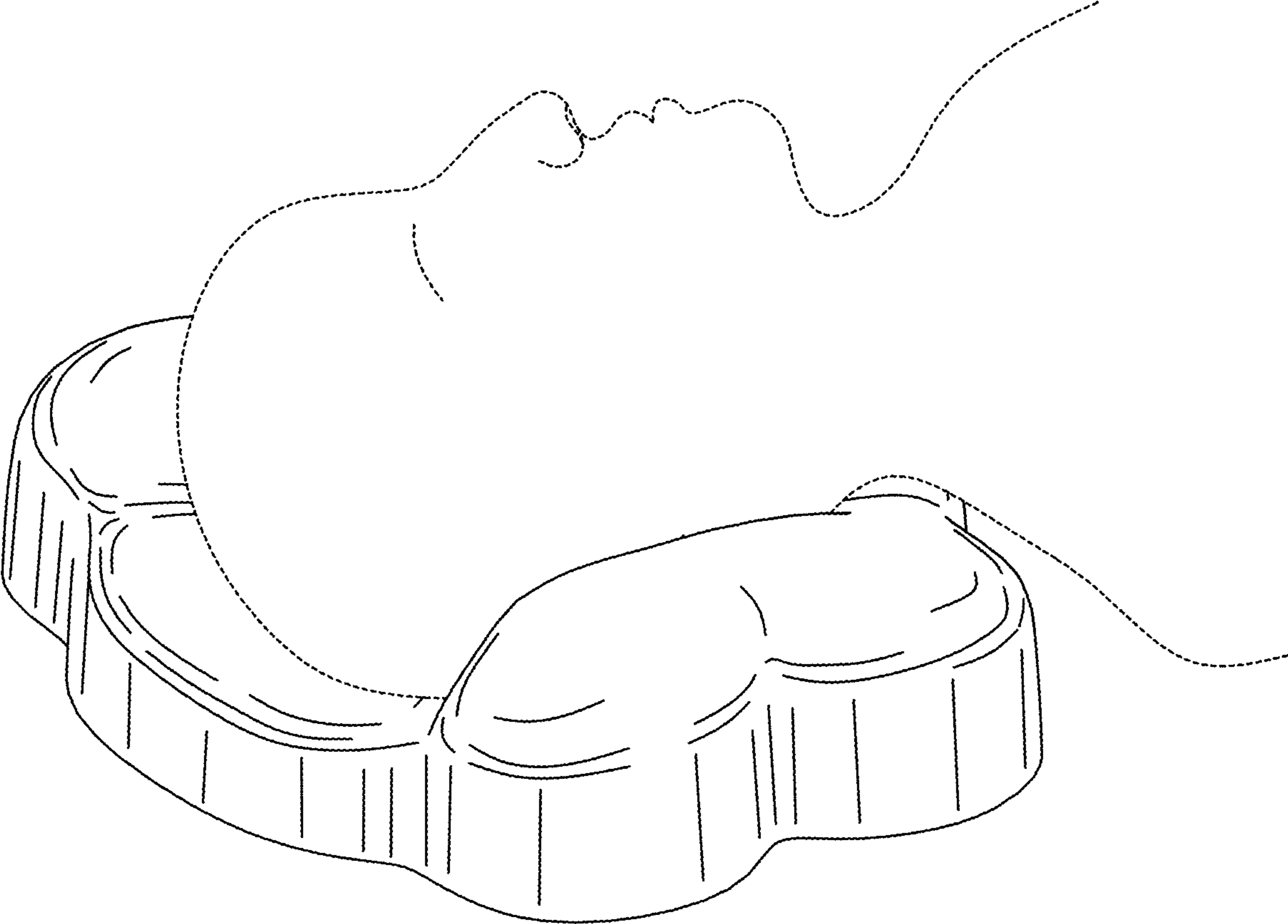

FIG. 8