



US00D985291S

(12) **United States Design Patent**  
**Wang**

(10) **Patent No.:** **US D985,291 S**

(45) **Date of Patent:** **\*\* May 9, 2023**

(54) **WATCH BAND**

(71) Applicant: **SHENZHEN XINZHIRUI TRADING CO., LTD.**, Shenzhen (CN)

(72) Inventor: **Ting Wang**, Shenzhen (CN)

(73) Assignee: **SHENZHEN XINZHIRUI TRADING CO., LTD.**, Shenzhen (CN)

(\*\*) Term: **15 Years**

(21) Appl. No.: **29/803,689**

(22) Filed: **Aug. 16, 2021**

(51) **LOC (14) Cl.** ..... **11-01**

(52) **U.S. Cl.**  
USPC ..... **D11/3; D11/19**

(58) **Field of Classification Search**  
USPC .... D11/1-25, 86, 87, 93, 94, 234, 235, 231;  
224/164, 175; 600/301; D10/30-39, 70,  
D10/46; 368/282, 285; D14/344;  
D24/167, 186, 187  
CPC .... G04B 37/1486; G04B 37/16; G04B 37/18;  
G04B 37/00; A44C 5/14; A44C 5/0053;  
A44C 5/0069; A44C 5/0076; A44C 5/00;  
A44C 5/0007; A44C 5/0015; A44C  
5/0023; A44C 5/003; A44C 5/0061; A44C  
5/12; A44C 5/147; A44C 5/18; A44C  
5/185; A44C 5/2047; A44C 5/2052; A44B  
11/006; A44B 11/24  
See application file for complete search history.

(56) **References Cited**

**U.S. PATENT DOCUMENTS**

D161,189 S \* 12/1950 Knibb ..... D11/20  
3,136,139 A \* 6/1964 Sinner ..... A44C 5/0076  
224/175  
D286,385 S \* 10/1986 Bulgari ..... D11/19  
D333,626 S \* 3/1993 Chang ..... D10/62  
D342,571 S \* 12/1993 Givens, Sr. .... D24/186  
D350,911 S \* 9/1994 Bert ..... D11/19

D355,866 S \* 2/1995 Prout ..... D11/19  
D432,446 S \* 10/2000 Santos ..... D11/5  
6,932,667 B1 \* 8/2005 Koxlien ..... A01M 31/004  
15/210.1  
D559,474 S \* 1/2008 Nguyen ..... D30/152  
D728,405 S \* 5/2015 Potts ..... D11/3

(Continued)

**FOREIGN PATENT DOCUMENTS**

CN 306628010 \* 6/2021  
KR 301190432.0000 \* 11/2022

**OTHER PUBLICATIONS**

Sport Loop [online] URL: [https://www.iphonejd.com/iphone\\_jd/2019/10/review-sport-loop-band.html](https://www.iphonejd.com/iphone_jd/2019/10/review-sport-loop-band.html) (site visited: Aug. 3, 2022)  
(Year: 2019).\*

(Continued)

*Primary Examiner* — Jae Liang  
*Assistant Examiner* — Tia Ruth-Renee Polidori  
(74) *Attorney, Agent, or Firm* — Nitin Kaushik

(57) **CLAIM**

The ornamental design for a watch band, as shown and described.

**DESCRIPTION**

FIG. 1 is a perspective view of a watch band showing my new design;  
FIG. 2 is a perspective view of the watch band where the watch band is in a configuration of use;  
FIG. 3 is a front elevational view thereof;  
FIG. 4 is a rear elevational view thereof;  
FIG. 5 is a left side elevational view thereof;  
FIG. 6 is a right side elevational view thereof;  
FIG. 7 is a top plan view thereof; and,  
FIG. 8 is a bottom plan view thereof.  
The broken lines in the drawings depict portions of the watch band and form no part of the claimed design.

**1 Claim, 8 Drawing Sheets**

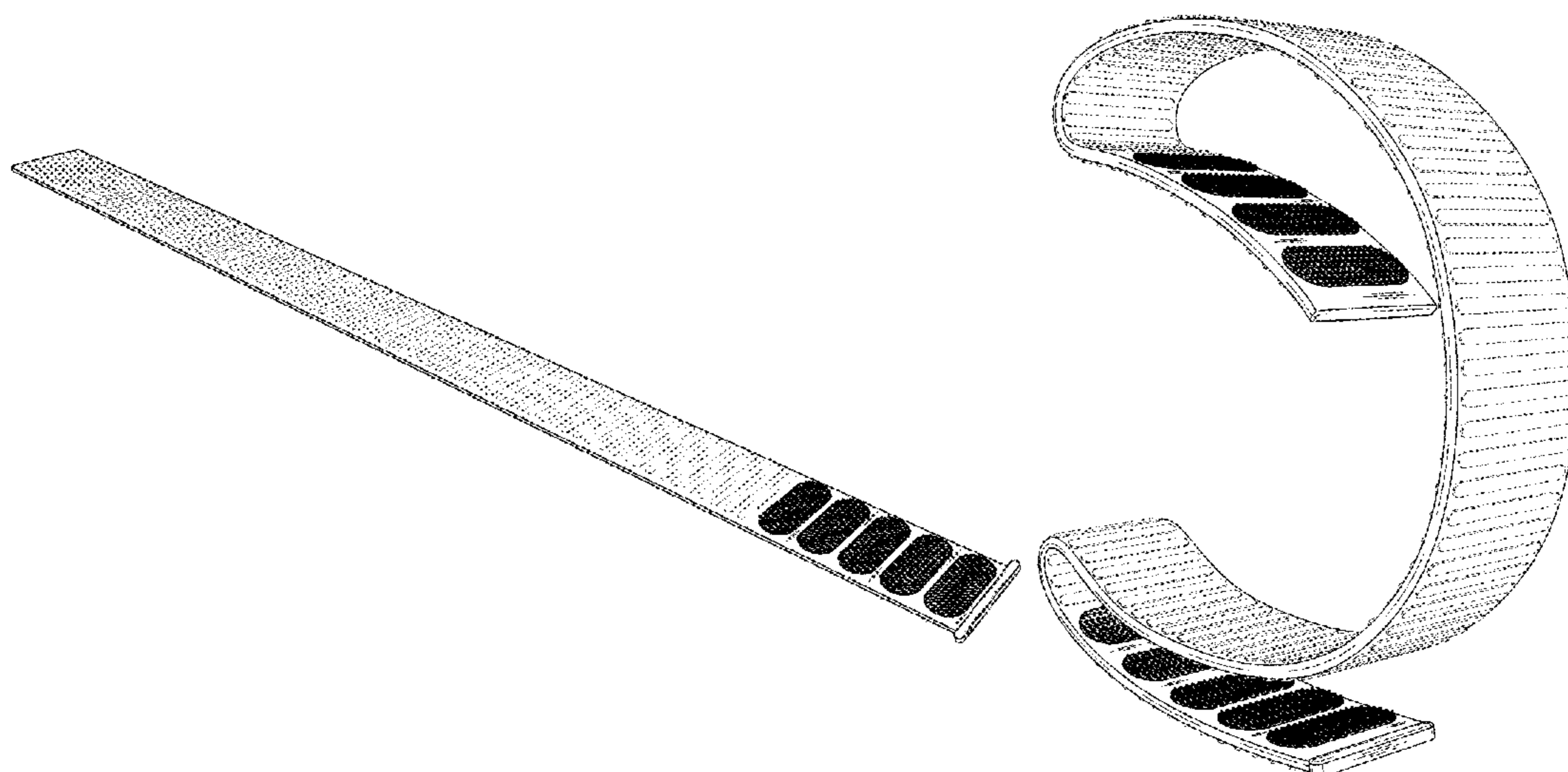

(56)

References Cited

U.S. PATENT DOCUMENTS

D746,707 S \* 1/2016 Akana ..... D10/70  
 D755,070 S \* 5/2016 Akana ..... D11/5  
 D757,722 S \* 5/2016 Akana ..... D10/70  
 D764,340 S \* 8/2016 Akana ..... D11/3  
 D764,341 S \* 8/2016 Akana ..... D11/3  
 D772,867 S \* 11/2016 Park ..... D10/70  
 D793,271 S 8/2017 Cerrato  
 D800,007 S 10/2017 Tibi  
 D813,076 S \* 3/2018 Akana ..... D11/5  
 D815,972 S \* 4/2018 Akana ..... D11/3  
 D817,203 S \* 5/2018 Akana ..... D10/103  
 D822,529 S \* 7/2018 Akana ..... D11/13  
 D837,082 S \* 1/2019 Akana ..... D11/3  
 D843,875 S \* 3/2019 Akana ..... D11/34  
 D854,961 S \* 7/2019 Akana ..... D11/3  
 D857,542 S \* 8/2019 Sun ..... D11/3  
 D863,096 S \* 10/2019 Akana ..... D11/3  
 D864,783 S \* 10/2019 Partrat ..... D11/3  
 D882,445 S \* 4/2020 Liao ..... D11/3  
 D883,837 S \* 5/2020 Akana ..... D11/3  
 D883,838 S \* 5/2020 Deng ..... D11/3  
 D896,677 S \* 9/2020 Wang ..... D11/3

D918,759 S \* 5/2021 Liu ..... D11/3  
 D929,884 S \* 9/2021 Yi ..... D11/3  
 D940,583 S \* 1/2022 Akana ..... D11/5  
 D947,184 S \* 3/2022 Akana ..... D14/344  
 D949,039 S \* 4/2022 Akana ..... D11/3  
 D955,255 S \* 6/2022 Cai ..... D11/3  
 D955,256 S \* 6/2022 Cao ..... D11/3  
 D956,609 S \* 7/2022 Yang ..... D11/3  
 D962,106 S \* 8/2022 Jiang ..... D11/3  
 2019/0029372 A1 \* 1/2019 Zhang ..... A44C 5/0015  
 2022/0273078 A1 \* 9/2022 Shaffer ..... A44C 5/14

OTHER PUBLICATIONS

Abanen [online] URL: <https://www.amazon.com/Abanen-Ultralight-Wristband-Sapphire-Instinct/dp/B092Q6KJ5D> (site visited: Aug. 3, 2022) (Year: 2021).\*

Xinytec [online] URL: <https://www.walmart.com/ip/XINYTEC-Connector-Surfing-Mouth-Mount-Set-For-GoPro-Hero-6-Camera-Accessory-Surf-Braces/1367329383> (site visited: Aug. 3, 2022) (Year: 2022).\*

Swiss Watch [online] URL: <https://www.youtube.com/watch?v=gHoQfyvUWBU&t=3s> (site visited: Nov. 16, 2022) (Year: 2021).\*

\* cited by examiner

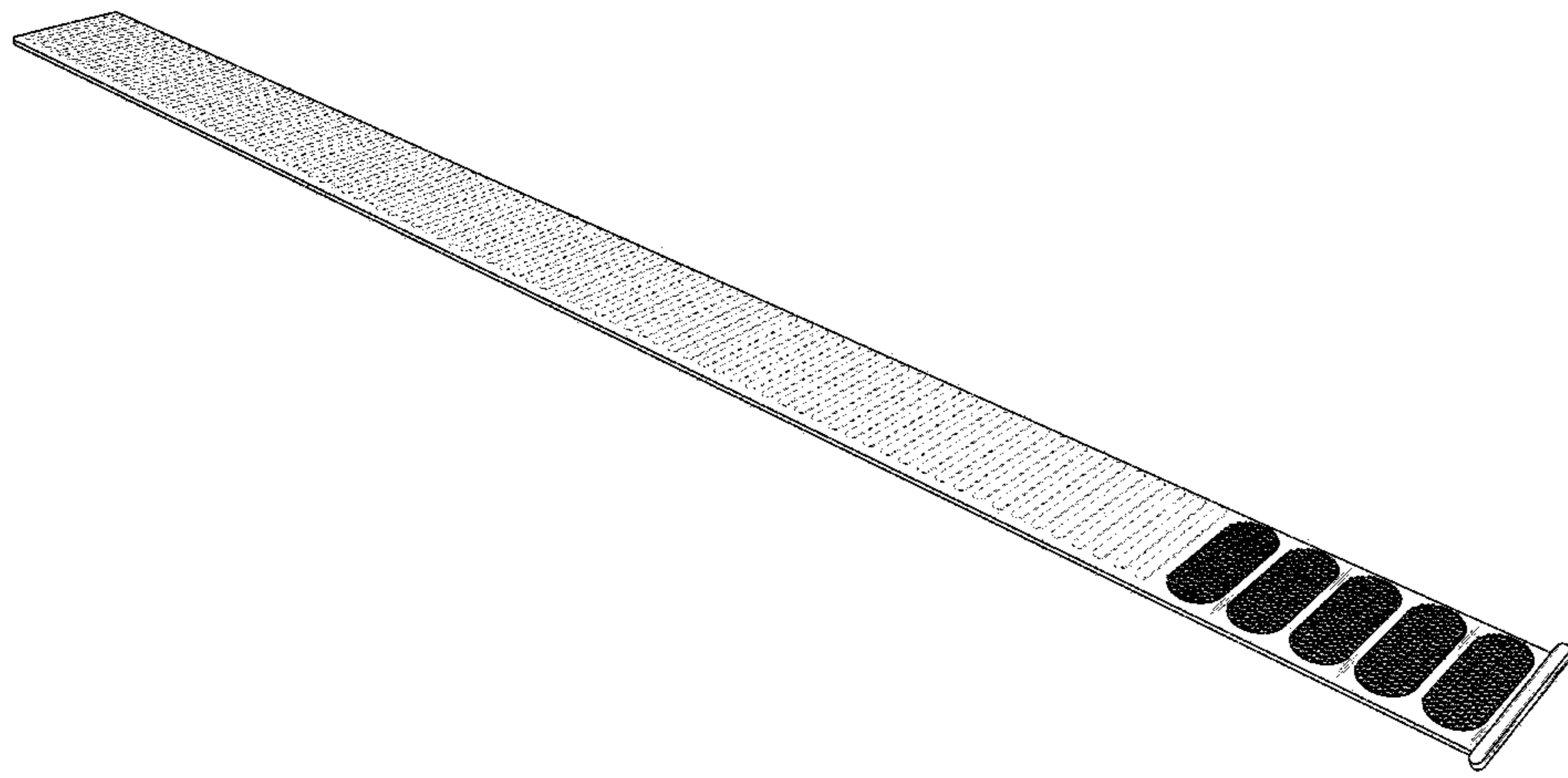

FIG. 1

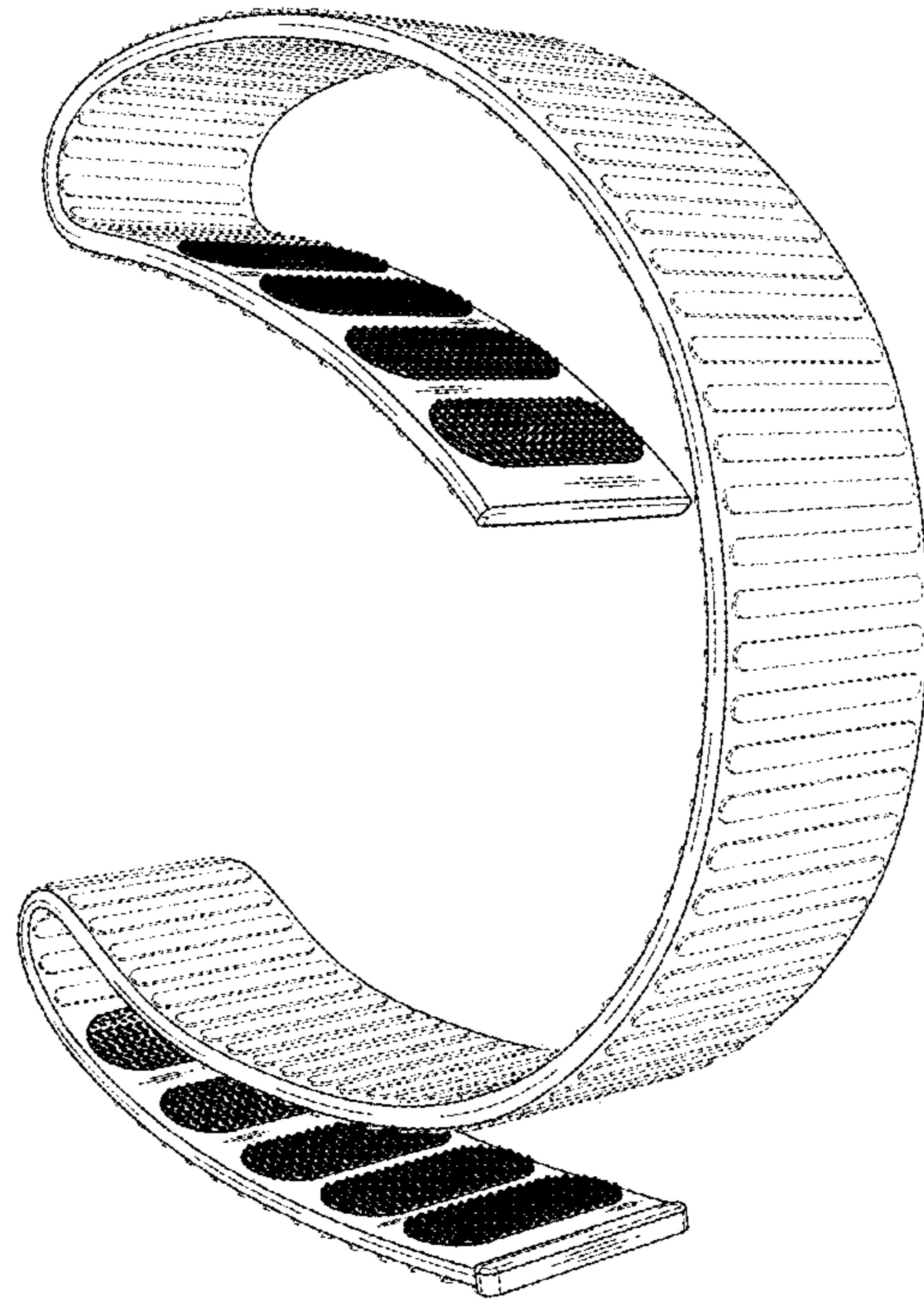

FIG. 2

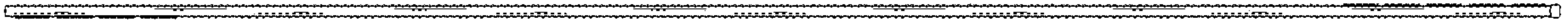

FIG. 3

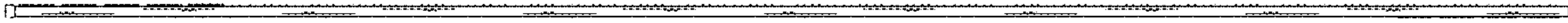

FIG. 4



FIG. 5

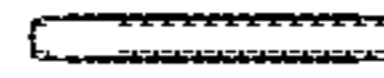

FIG. 6



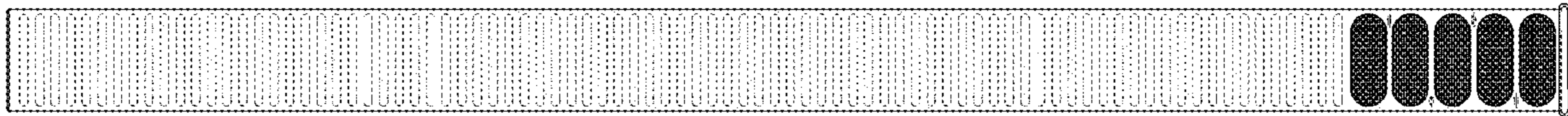

FIG. 7

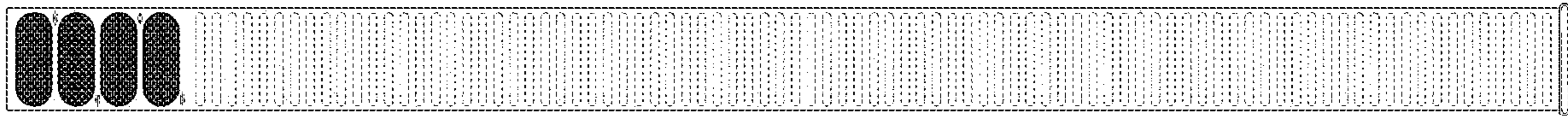

FIG. 8