



US00D985248S

(12) **United States Design Patent** (10) **Patent No.:** **US D985,248 S**  
**Haire** (45) **Date of Patent:** **\*\* May 9, 2023**

(54) **FOOTBED FOR A SHOE**

(71) Applicant: **FRANKIE4 IP 1 Pty Ltd,**  
Indooroopilly (AU)  
(72) Inventor: **Caroline Rose Haire,** Indooroopilly  
(AU)  
(73) Assignee: **FRANKIE4 IP PTY LTD,**  
Indooroopilly (AU)

(\*\*) Term: **15 Years**

(21) Appl. No.: **29/799,859**

(22) Filed: **Jul. 16, 2021**

(30) **Foreign Application Priority Data**

Jan. 21, 2021 (AU) ..... 202110253  
Mar. 3, 2021 (AU) ..... 202111196

(51) **LOC (14) Cl.** ..... **02-04**

(52) **U.S. Cl.**  
USPC ..... **D2/961**

(58) **Field of Classification Search**  
USPC ..... D2/961, 908, 951, 953, 954, 957, 958,  
D2/960; D24/124, 192

(Continued)

(56) **References Cited**

**U.S. PATENT DOCUMENTS**

D328,967 S \* 9/1992 Brown ..... D2/961  
D396,138 S \* 7/1998 Roy ..... D2/961

(Continued)

**FOREIGN PATENT DOCUMENTS**

CA 203660 \* 11/2022  
CN 304970413 \* 1/2019  
KR 300618610.0000 \* 10/2011

**OTHER PUBLICATIONS**

Madamoesele, What's all the Fuss About, dated Jun. 29, 2018,  
viewed Nov. 22, 2022, available at URL: <https://www.mademoiselle.com/frankie4-shoes-whats-all-the-fuss-about/> (Year: 2018).\*

(Continued)

*Primary Examiner* — Jennifer L Rempfer

*Assistant Examiner* — Adrienne Corna

(74) *Attorney, Agent, or Firm* — Leydig, Voit & Mayer,  
Ltd.

(57) **CLAIM**

The ornamental design for a footbed for a shoe, as shown  
and described.

**DESCRIPTION**

FIG. 1 is a top, rear and inner-side isometric view of a  
footbed for a shoe.

FIG. 2 is a front view of the footbed of FIG. 1.

FIG. 3 is a rear view of the footbed of FIG. 1.

FIG. 4 is an outer-side view of the footbed of FIG. 1.

FIG. 5 is an inner-side view of the footbed of FIG. 1.

FIG. 6 is a top view of the footbed of FIG. 1.

FIG. 7 is a bottom view of the footbed of FIG. 1.

FIG. 8 is a top, front and inner-side isometric view of the  
footbed of FIG. 1

FIG. 9 is a top, rear and outer-side isometric view of the  
footbed of FIG. 1.

FIG. 10 is a top, front and outer-side isometric view of the  
footbed of FIG. 1.

FIG. 11 is a cross-sectional view of the footbed taken along  
line 11-11 of FIG. 6.

FIG. 12 is a cross-sectional view of the footbed taken along  
line 12-12 of FIG. 6.

FIG. 13 is a cross-sectional view of the footbed taken along  
line 13-13 of FIG. 6.

FIG. 14 is a top, rear and inner-side isometric view of a  
footbed for a shoe.

FIG. 15 is a front view of the footbed of FIG. 14.

FIG. 16 is a rear view of the footbed of FIG. 14.

(Continued)

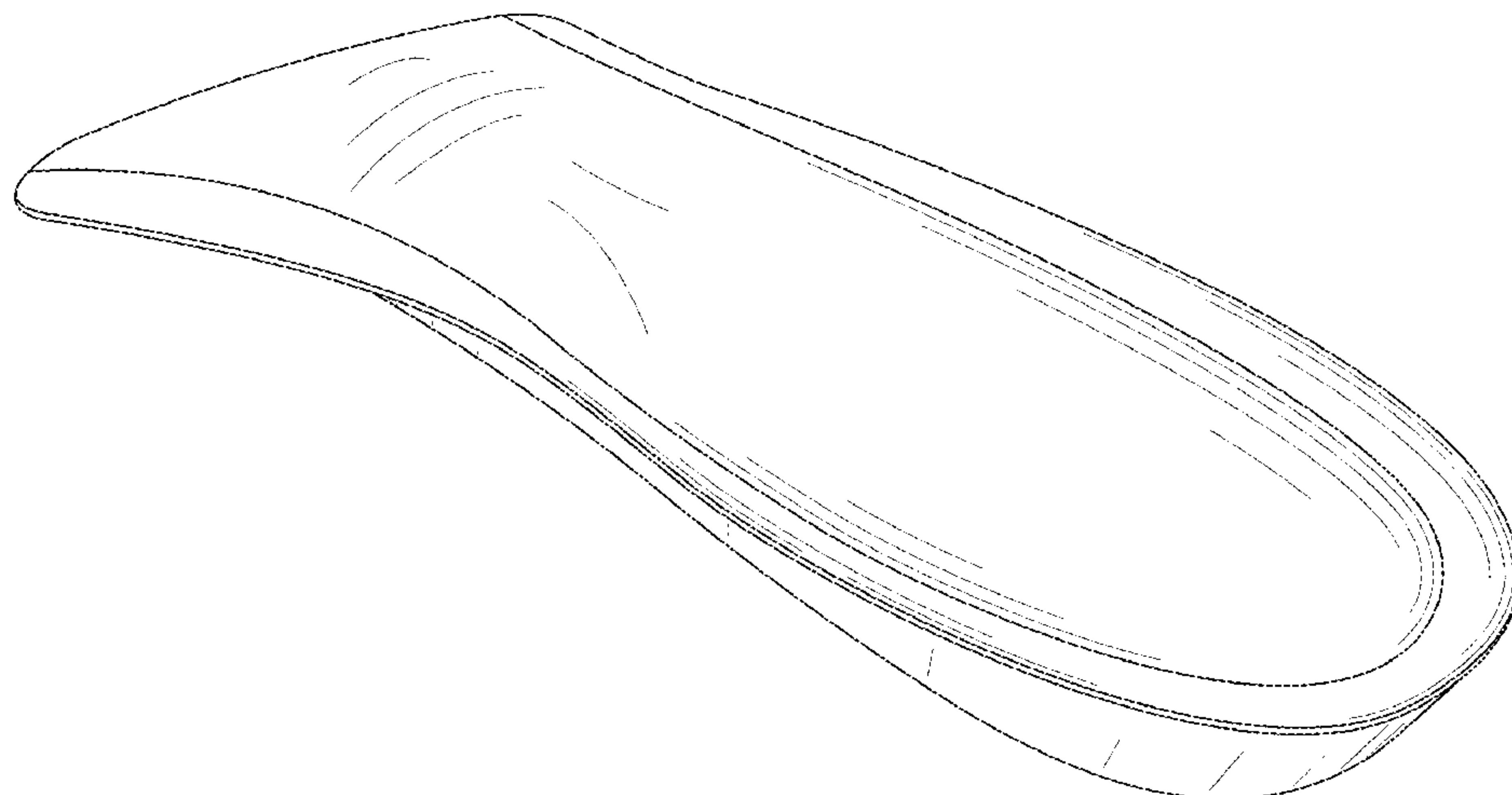

FIG. 17 is an outer-side view of the footbed of FIG. 14.  
 FIG. 18 is an inner-side view of the footbed of FIG. 14.  
 FIG. 19 is a top view of the footbed of FIG. 14.  
 FIG. 20 is a bottom view of the footbed of FIG. 14.  
 FIG. 21 is a top, front and inner-side isometric view of the footbed of FIG. 14  
 FIG. 22 is a top, rear and outer-side isometric view of the footbed of FIG. 14.  
 FIG. 23 is a top, front and outer-side isometric view of the footbed of FIG. 14.  
 FIG. 24 is a cross-sectional view of the footbed taken along line 24-24 of FIG. 19.  
 FIG. 25 is a cross-sectional view of the footbed taken along line 25-25 of FIG. 19; and,  
 FIG. 26 is a cross-sectional view of the footbed taken along line 26-26 of FIG. 19.

**1 Claim, 26 Drawing Sheets**

(58) **Field of Classification Search**  
 CPC ..... A43B 17/026; A43B 3/26  
 See application file for complete search history.

(56) **References Cited**

U.S. PATENT DOCUMENTS

D462,510	S	*	9/2002	Goodrich	.....	D2/961
D498,577	S	*	11/2004	Crewdson	.....	D2/961
D582,641	S	*	12/2008	Kielt	.....	D2/961
D614,842	S	*	5/2010	Vasyli	.....	D2/961
D617,086	S	*	6/2010	Avent	.....	D2/961
D658,358	S	*	5/2012	Polifroni	.....	D2/961
D666,395	S	*	9/2012	Garma	.....	D2/961

D666,396	S	*	9/2012	Garma	.....	D2/961
D666,397	S	*	9/2012	Garma	.....	D2/961
D707,936	S	*	7/2014	Nash	.....	D2/961
D748,387	S	*	2/2016	Wert	.....	D2/961
D791,456	S	*	7/2017	Charlesworth	.....	D2/961
D801,662	S	*	11/2017	Manolian	.....	D2/961
D961,216	S	*	8/2022	Qin	.....	D2/961
2004/0025376	A1	*	2/2004	Grisoni	.....	A43B 13/41 36/44
2007/0022630	A1	*	2/2007	Lundy	.....	A43B 13/386 36/43
2007/0180738	A1	*	8/2007	Milbourn	.....	A61F 5/14 36/180
2008/0072461	A1	*	3/2008	Howlett	.....	A43B 7/142 36/145
2009/0145003	A1	*	6/2009	Kim	.....	A43B 7/144 36/43
2011/0192050	A1	*	8/2011	Hane	.....	A43B 7/142 36/44
2016/0198794	A1	*	7/2016	Wakeland	.....	A43B 7/1485 36/44
2021/0251335	A1	*	8/2021	Haire	.....	A43B 7/1464
2022/0248806	A1	*	8/2022	Haire	.....	A43B 7/1464

OTHER PUBLICATIONS

Footsoothers "R3D ¾ Insoles," dated before Jan. 21, 2021, viewed on Nov. 22, 2022, available at URL: [https://www.etsy.com/listing/766327418/footsoothers-r3d-34-orthotic-insoles?click\\_key=307ea9a46440cbb89f31fd8f53077a6ebc07aef3%3A766327418&click\\_sum=c16e3c45&rec\\_type=ss&ref=landingpage\\_similar\\_listing\\_top-8](https://www.etsy.com/listing/766327418/footsoothers-r3d-34-orthotic-insoles?click_key=307ea9a46440cbb89f31fd8f53077a6ebc07aef3%3A766327418&click_sum=c16e3c45&rec_type=ss&ref=landingpage_similar_listing_top-8) (Year: 2022).\*

Frankie4 "Sole Saver Pack." dated Nov. 22, 2022, viewed on Nov. 22, 2022, available at URL: <https://us.frankie4.com/pages/sole-saver-pack> (Year: 2022).\*

U.S. Appl. No. 29/784,829, filed May 21, 2021.

\* cited by examiner

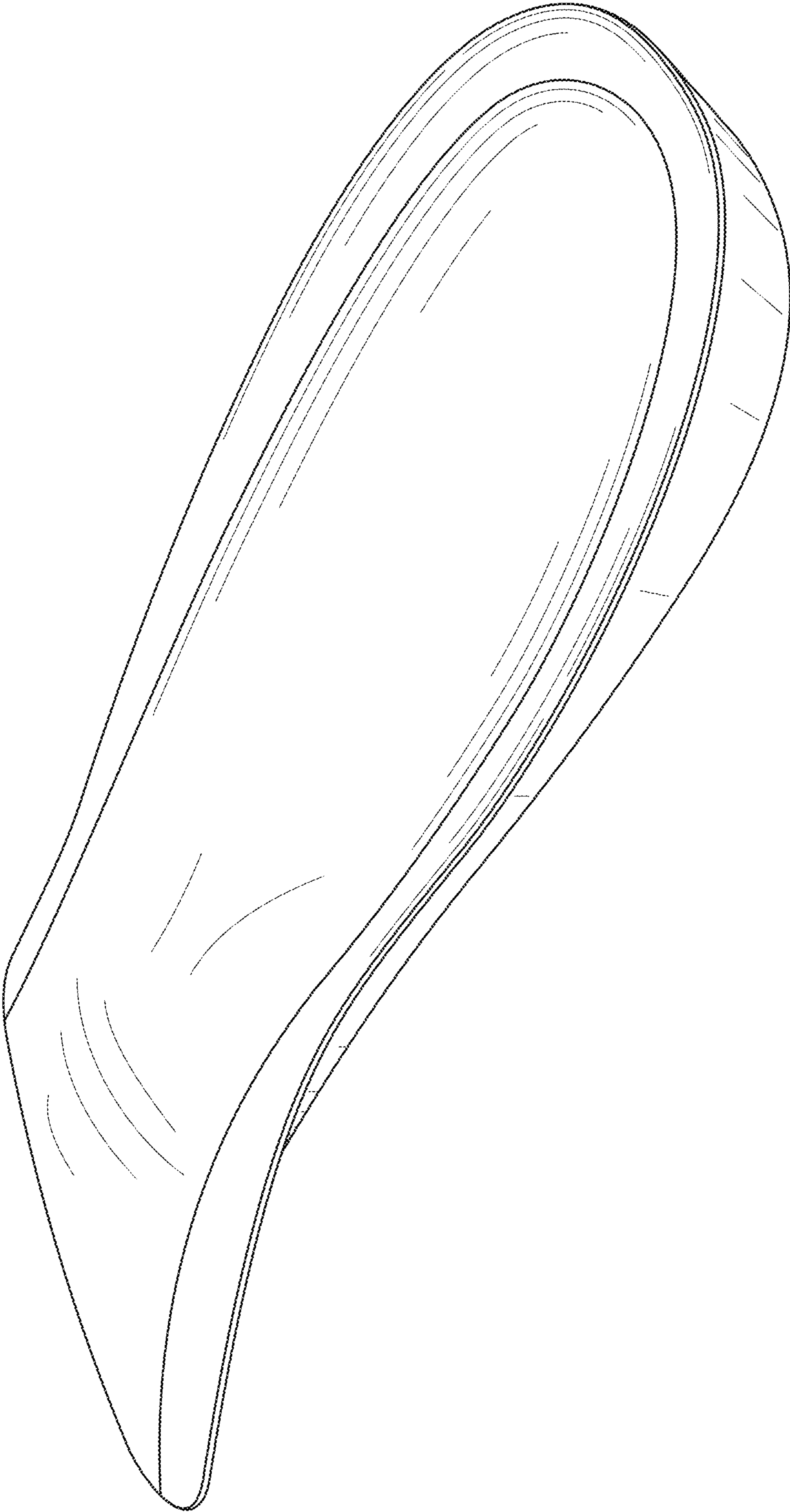

FIG. 1

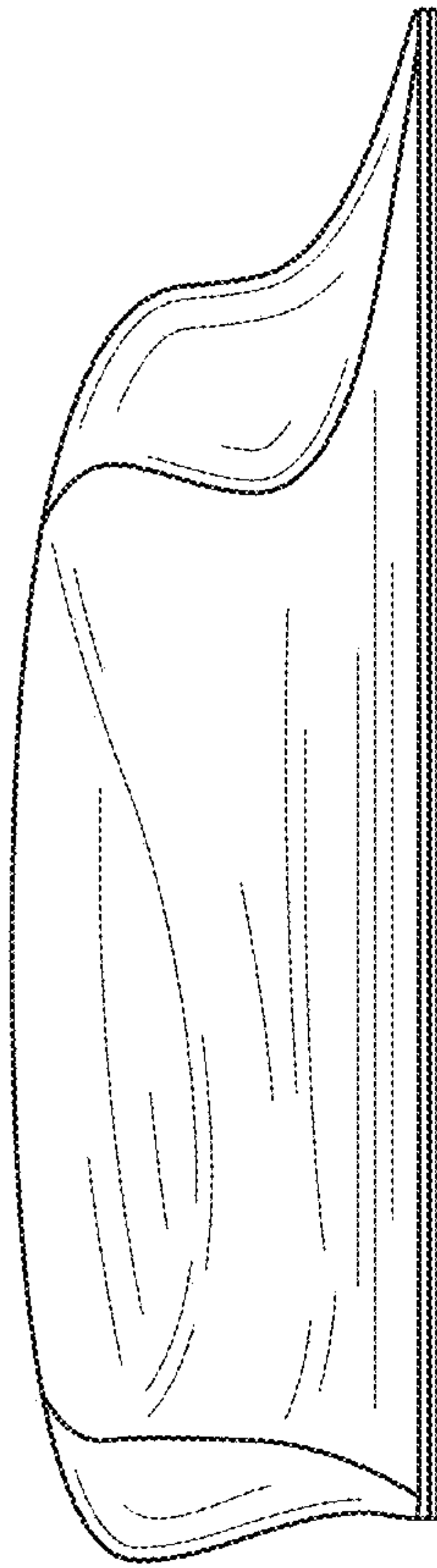

FIG. 2



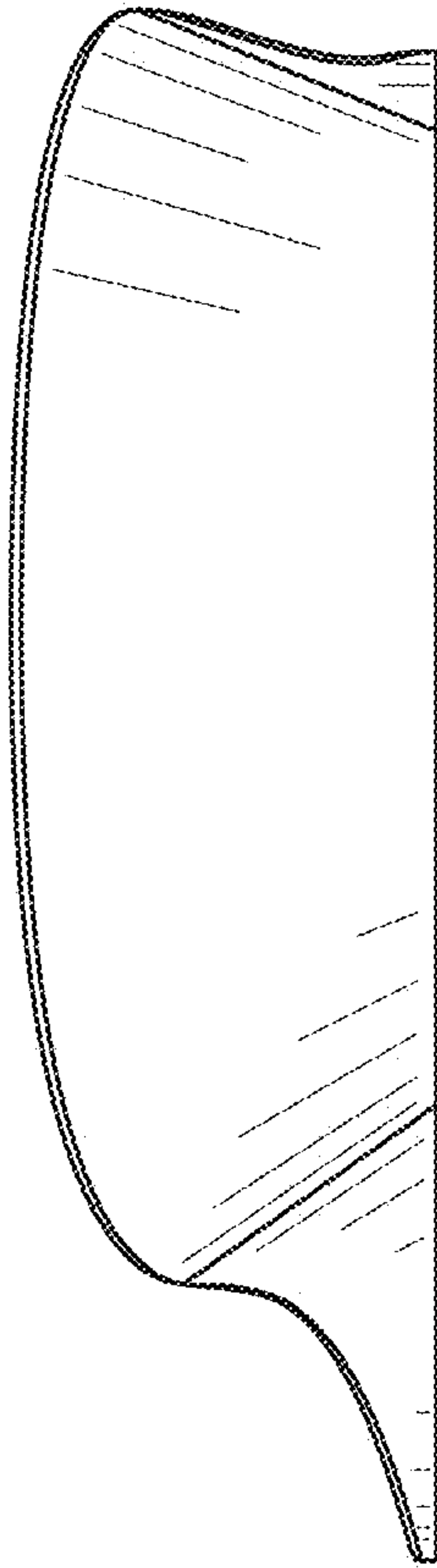

FIG. 3

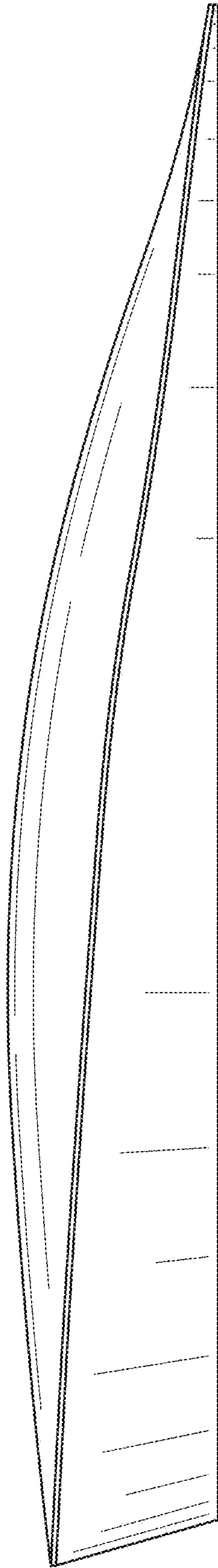

FIG. 4

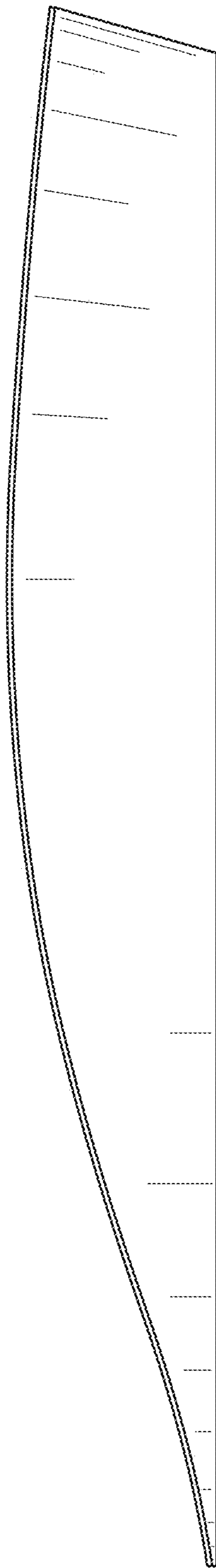

FIG. 5

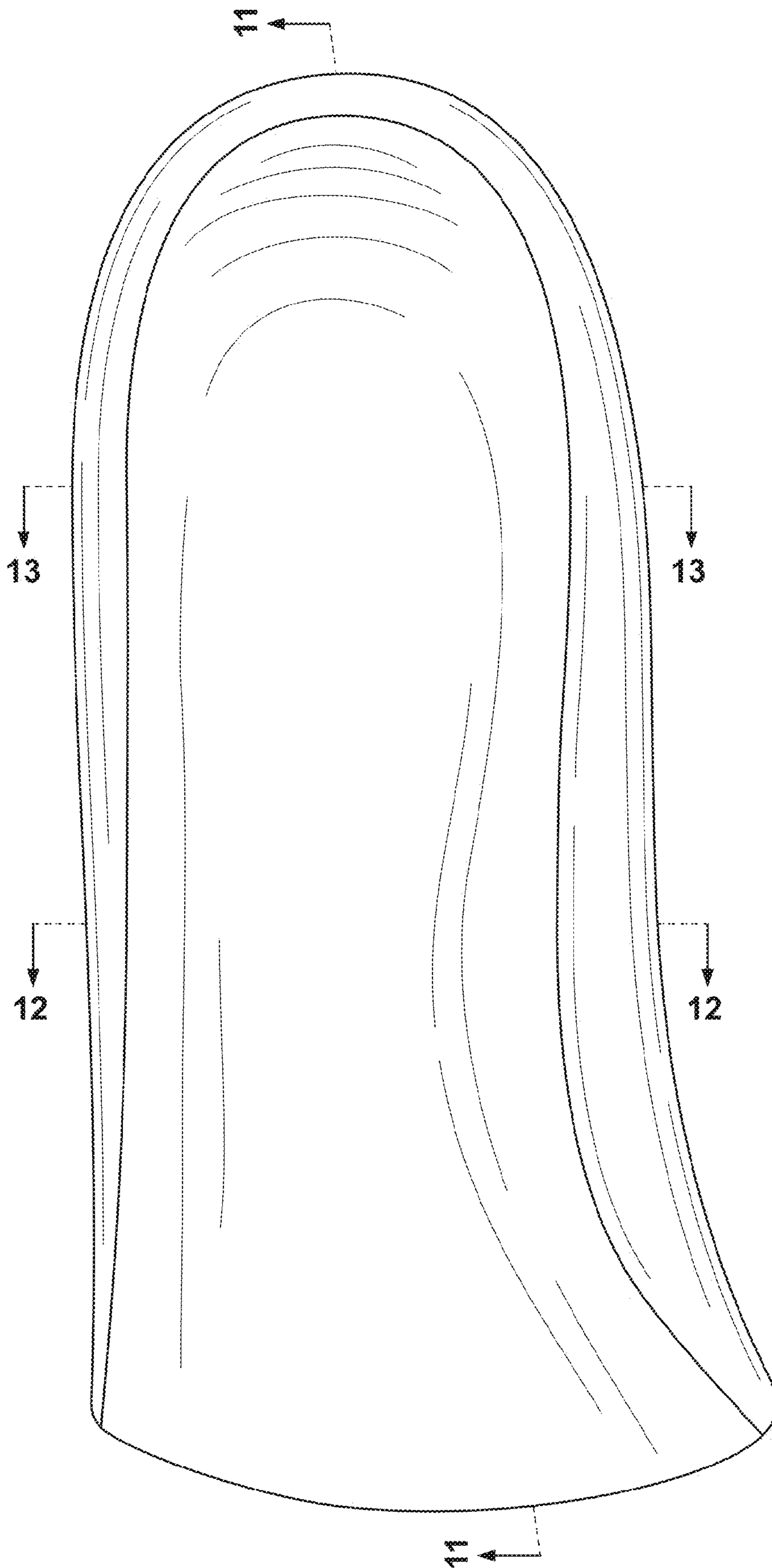

FIG. 6



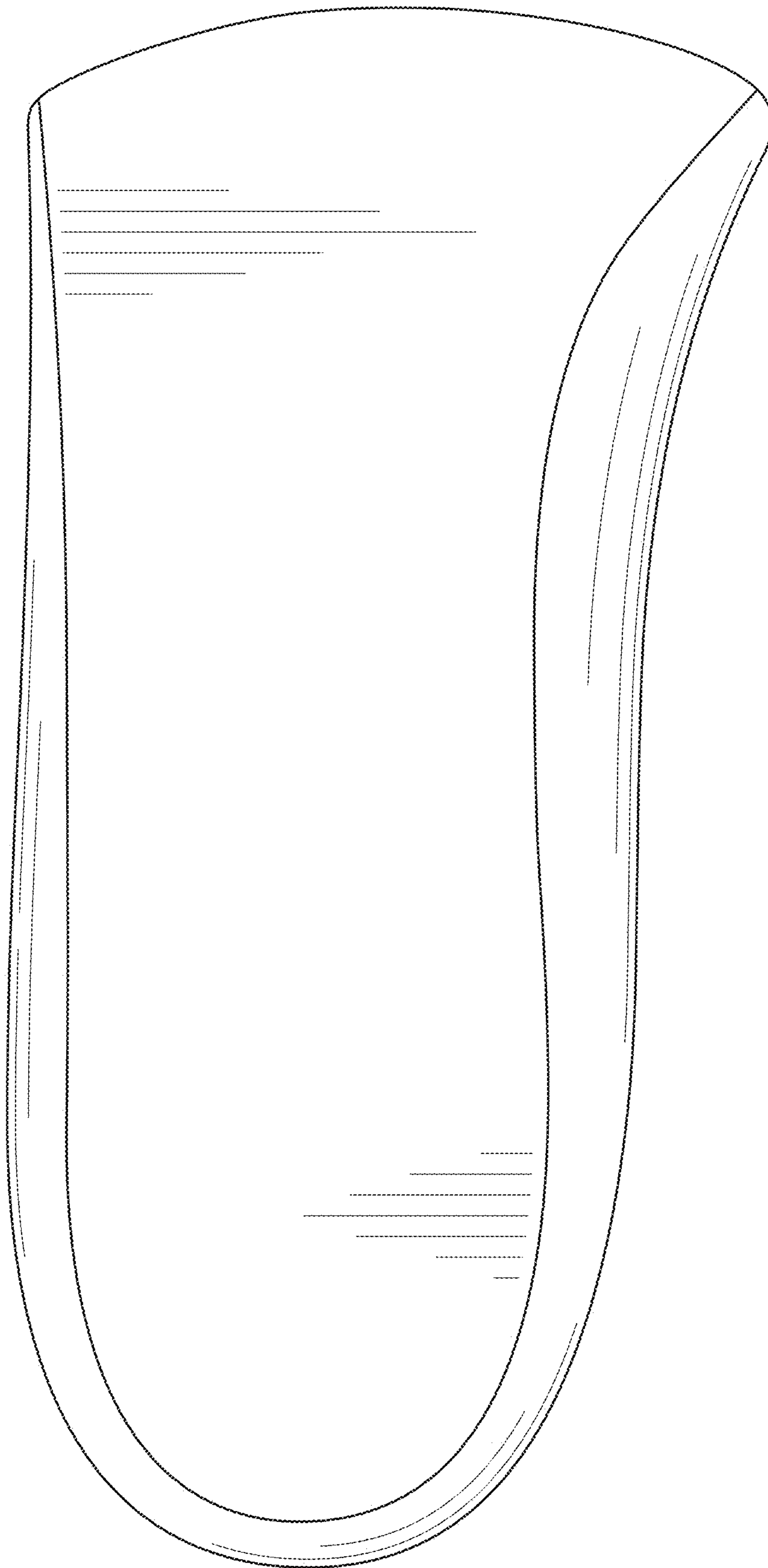

FIG. 7



FIG. 8



FIG. 9

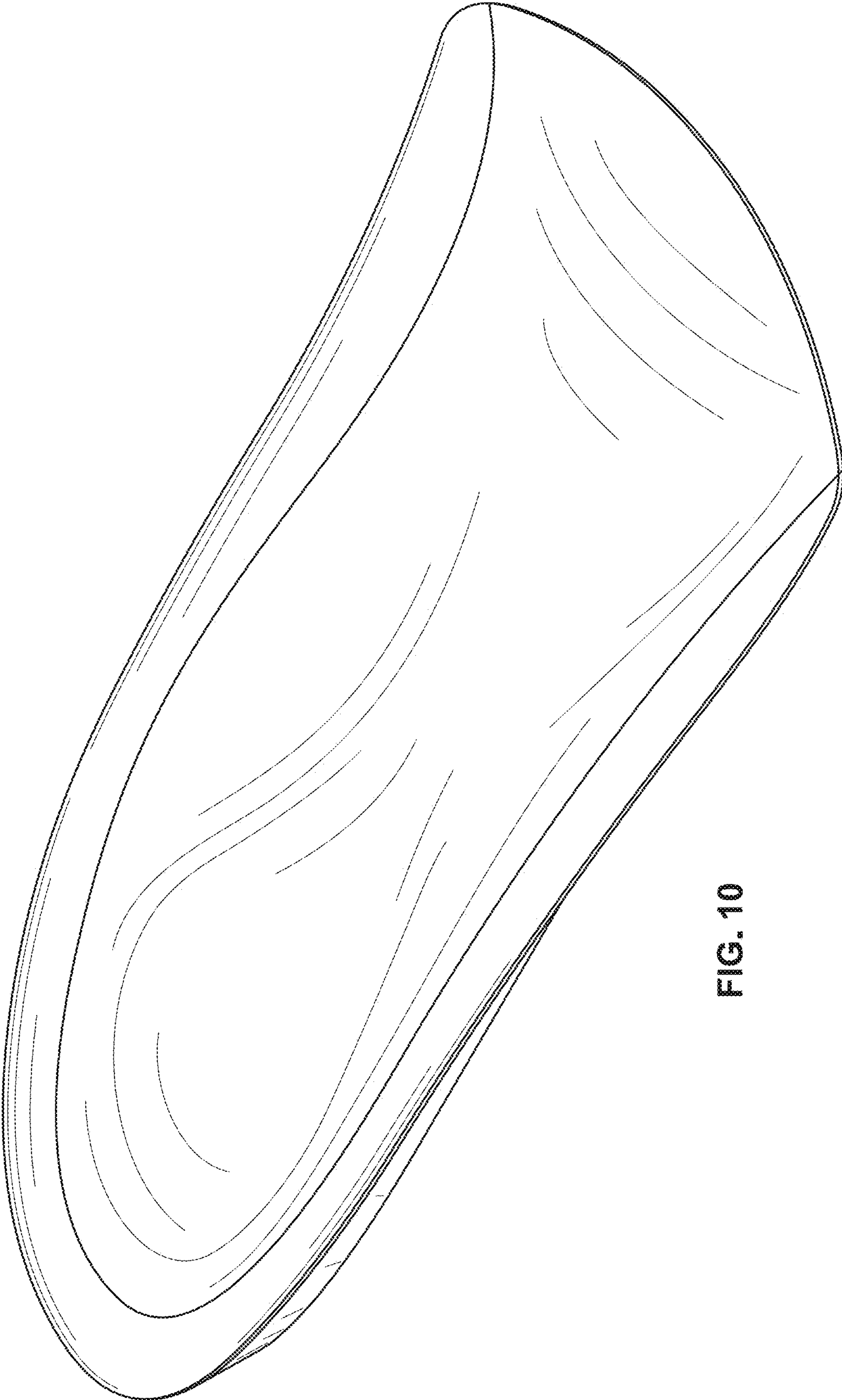

FIG. 10

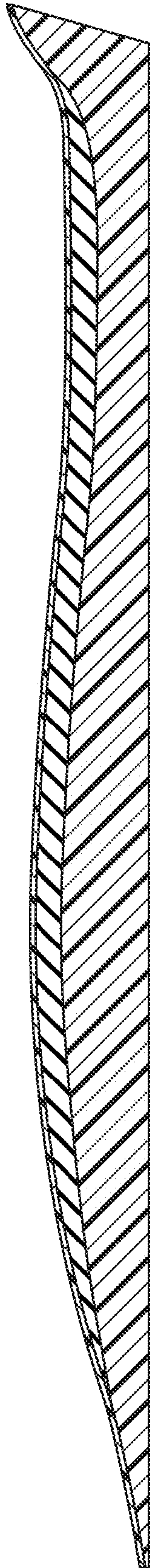

FIG. 11



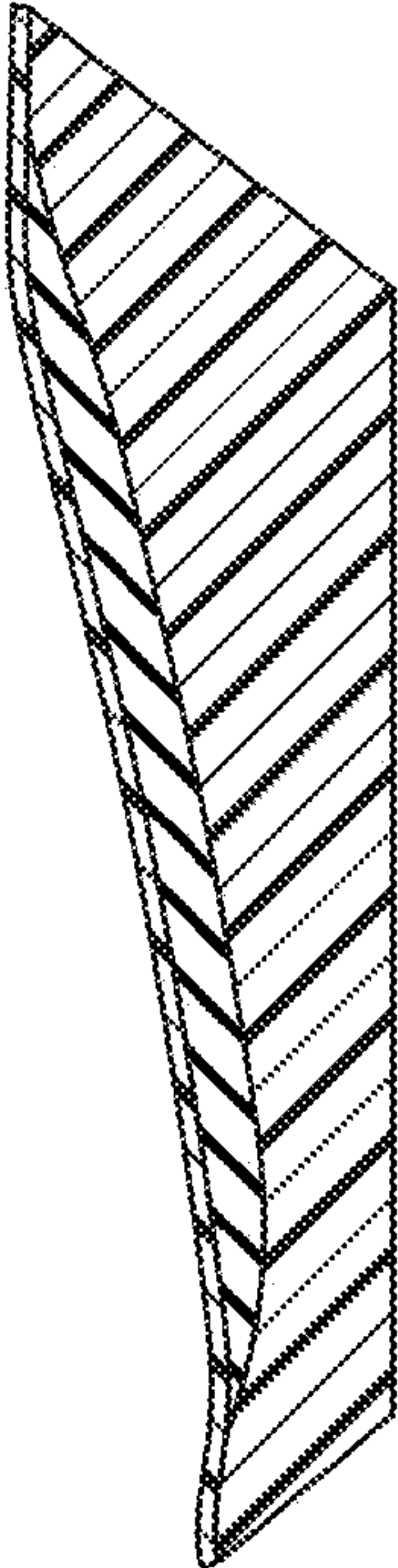

FIG. 12

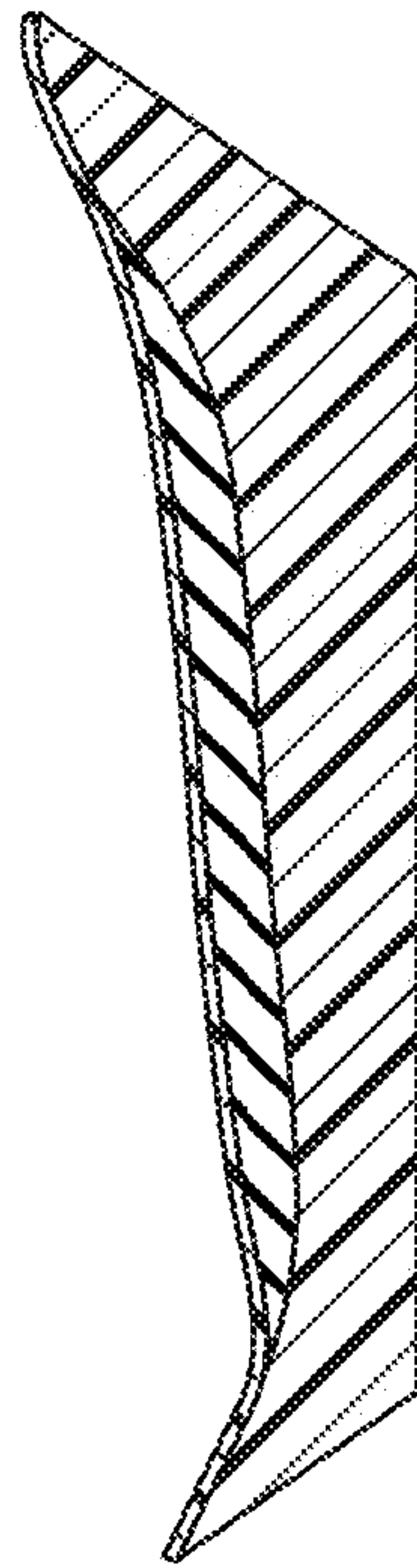

FIG. 13



FIG. 14

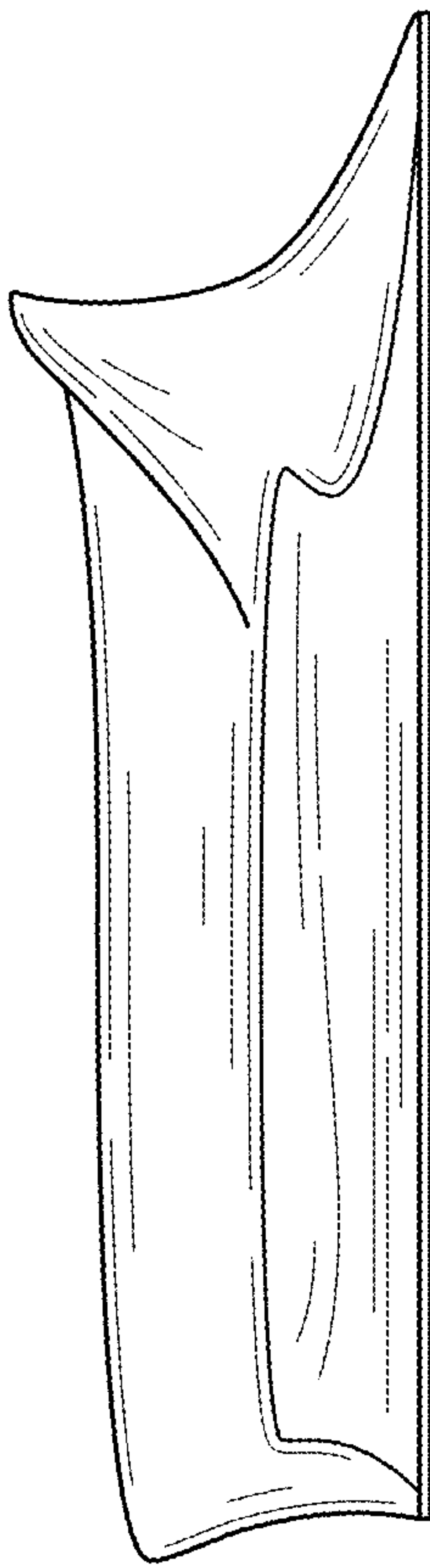

FIG. 15

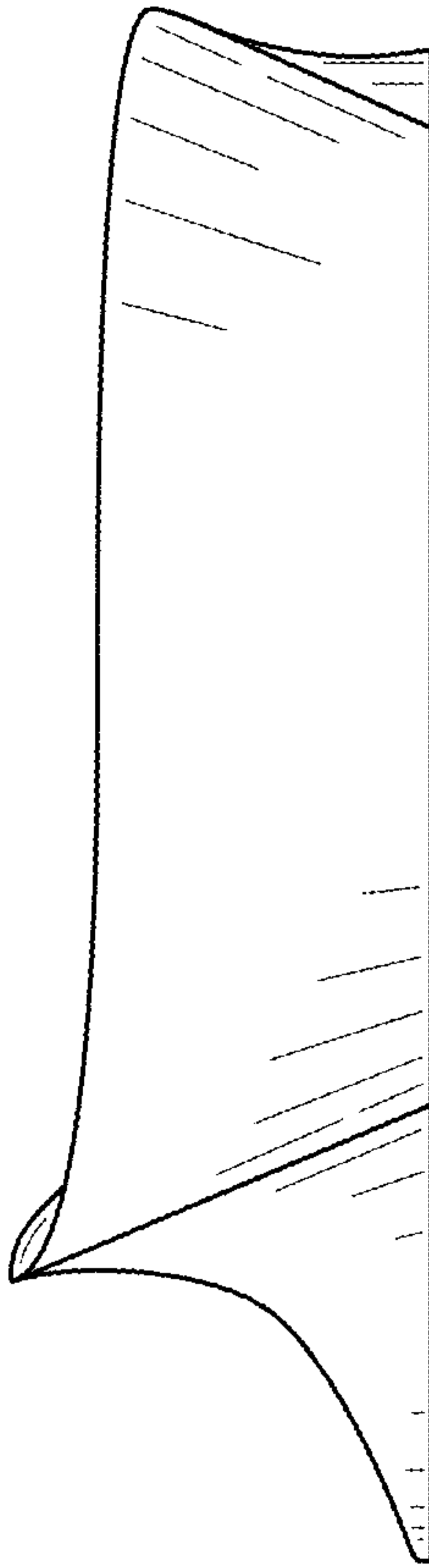

FIG. 16



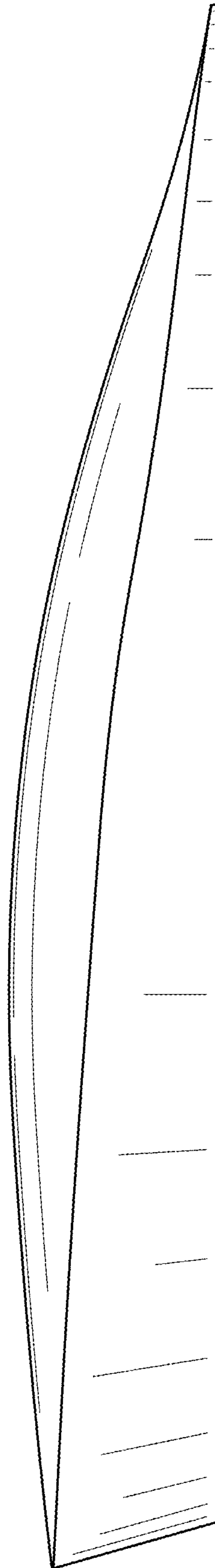

FIG. 17

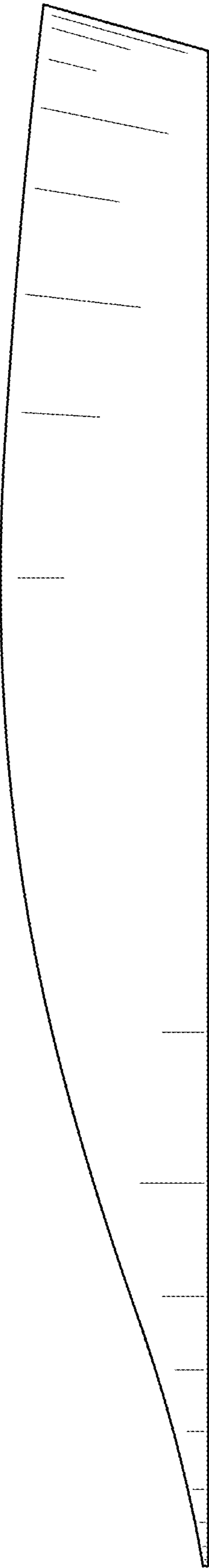

FIG. 18

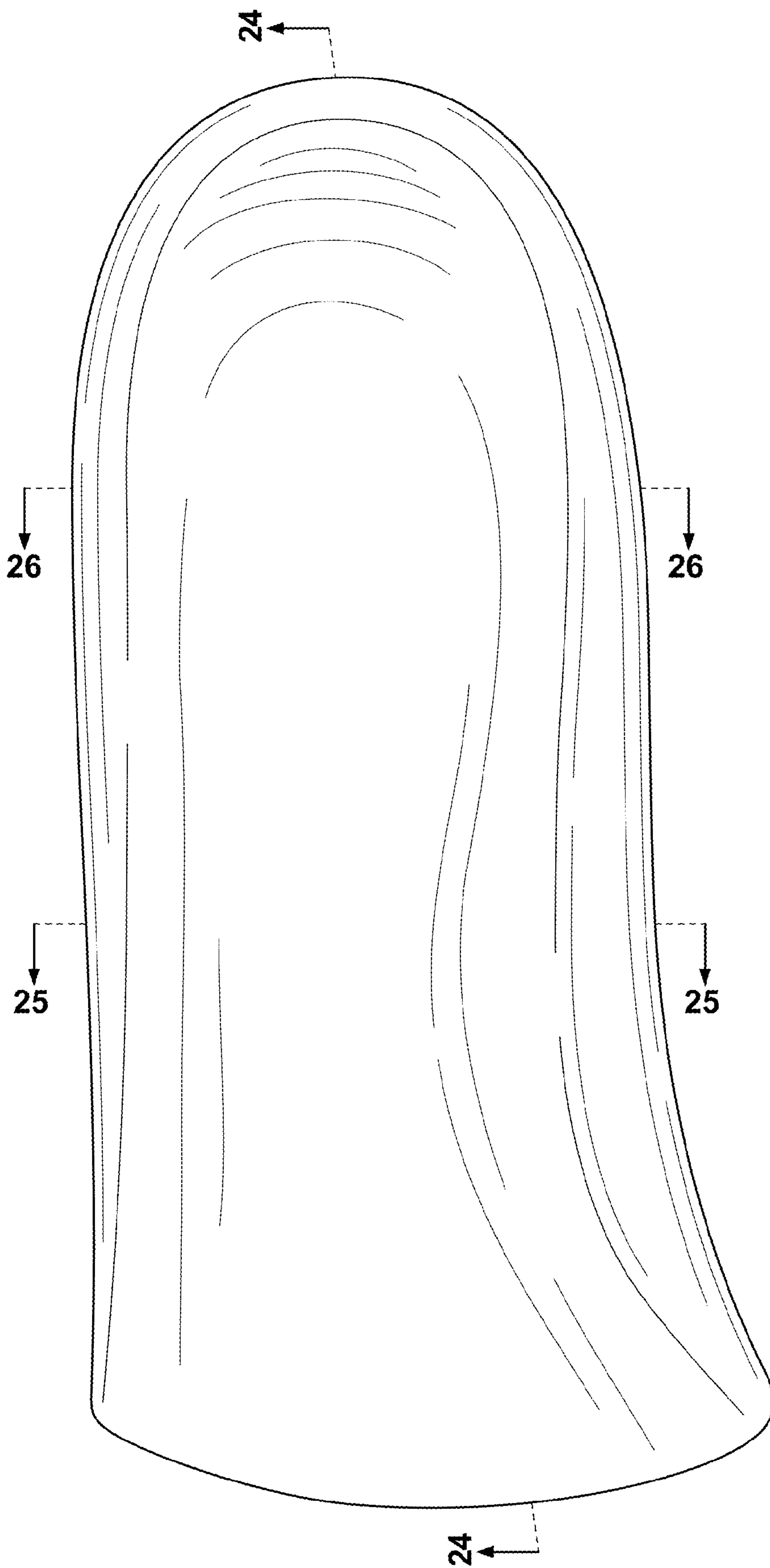

FIG. 19

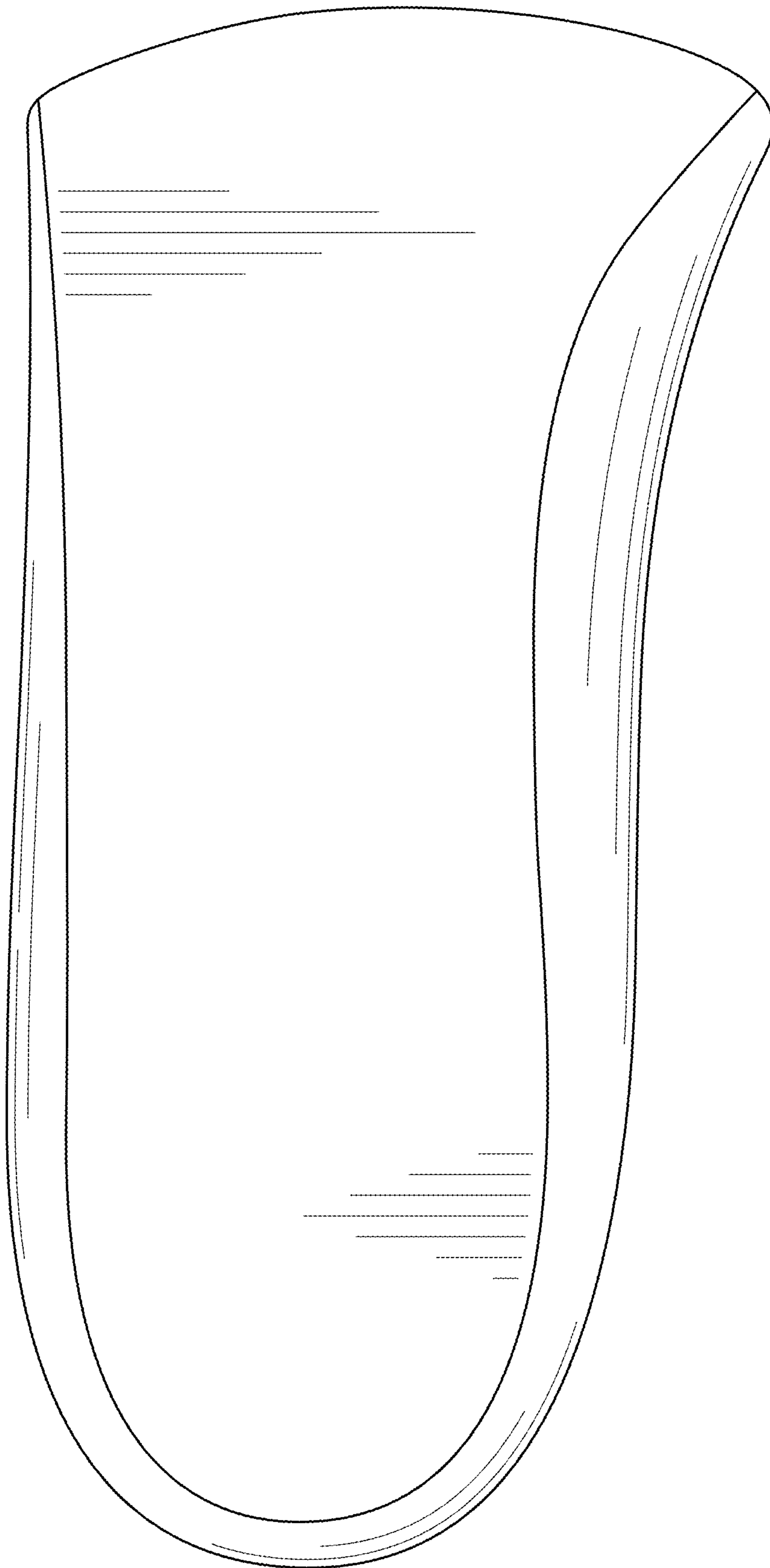

FIG. 20



FIG. 21



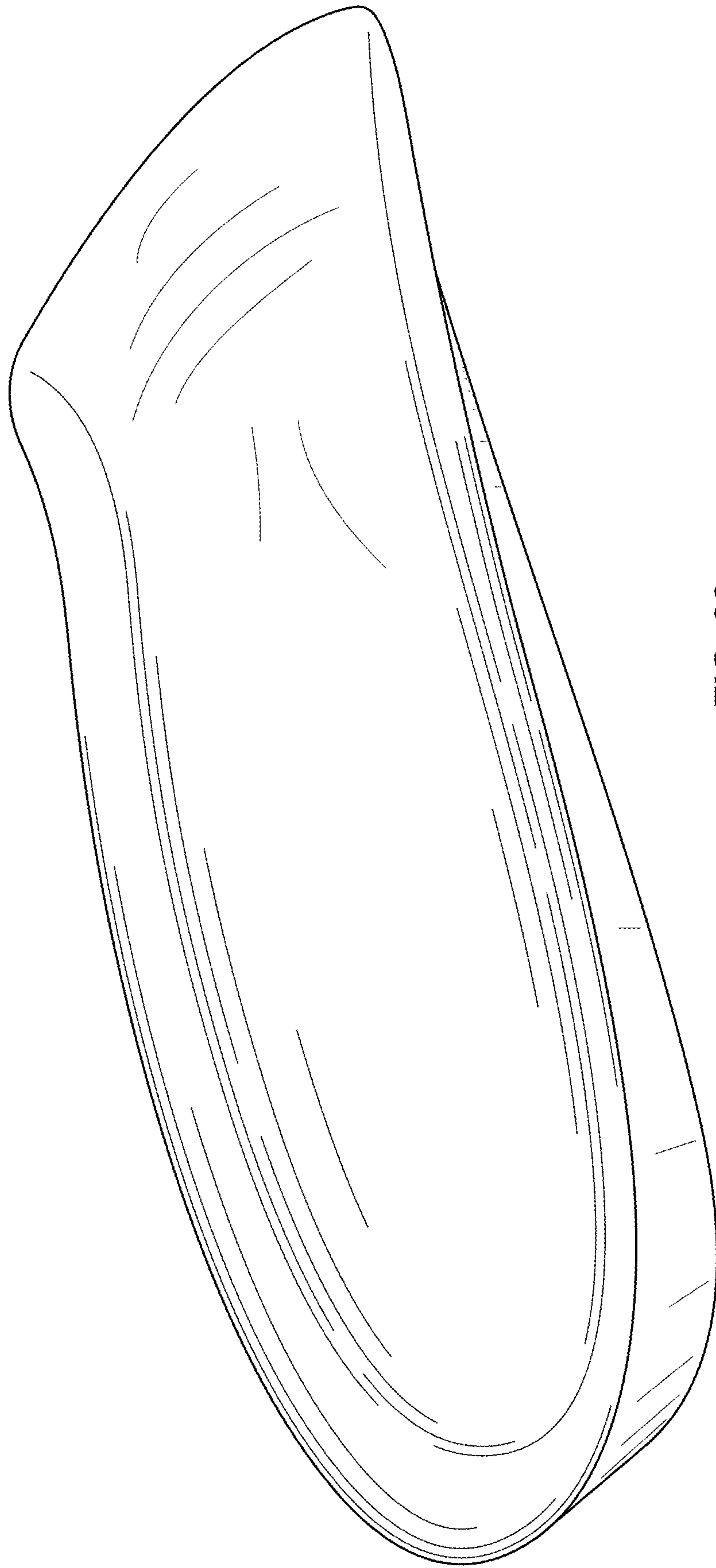

FIG. 22

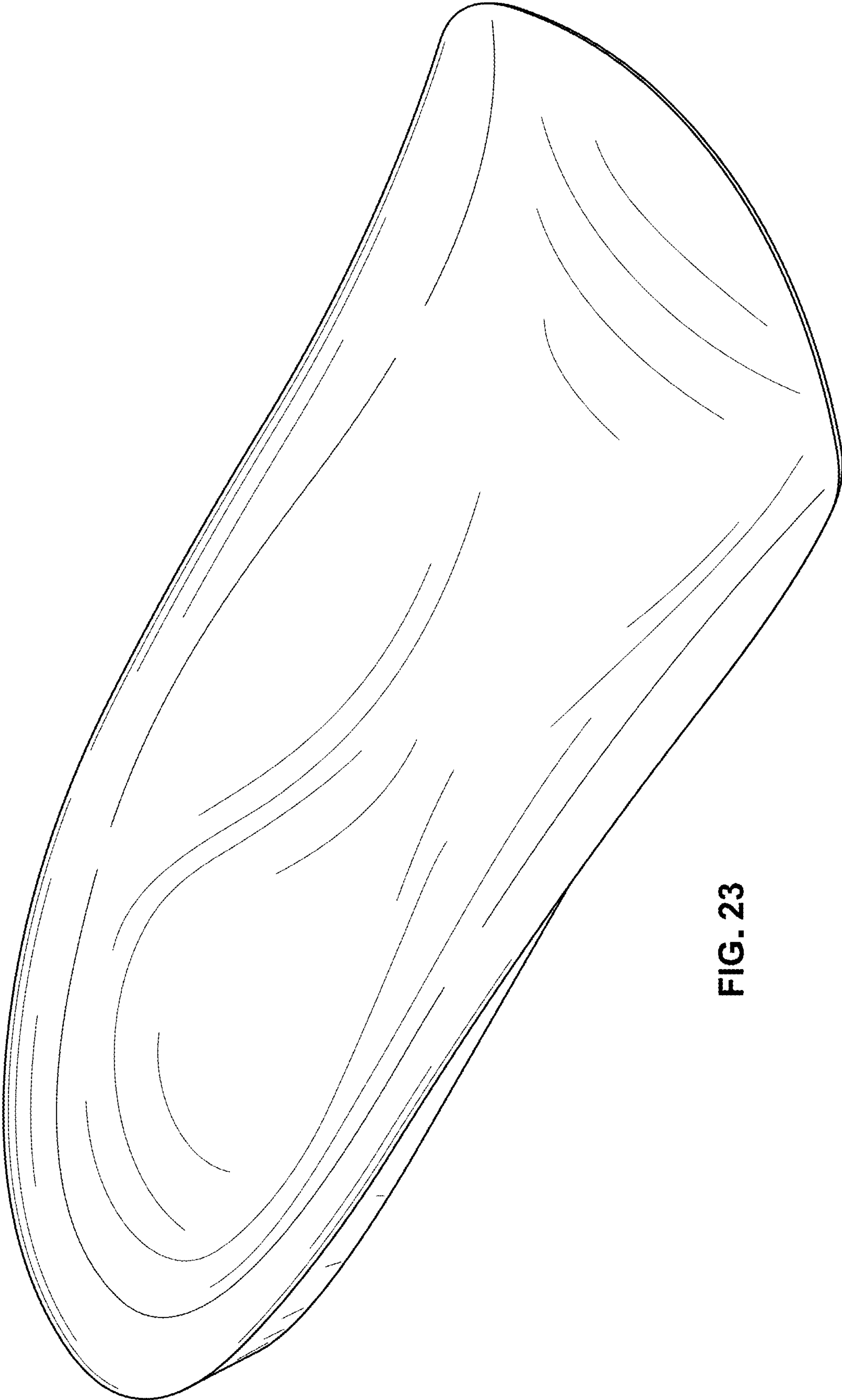

FIG. 23

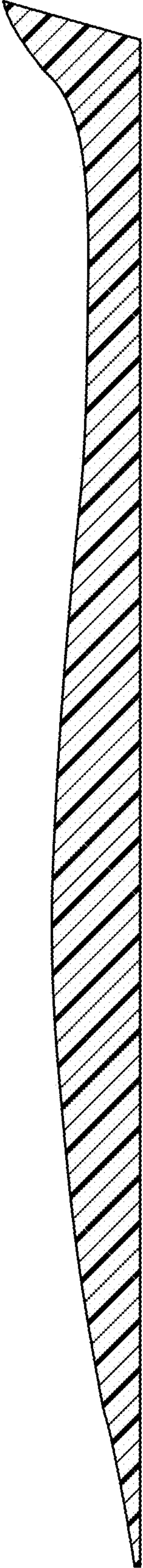

FIG. 24

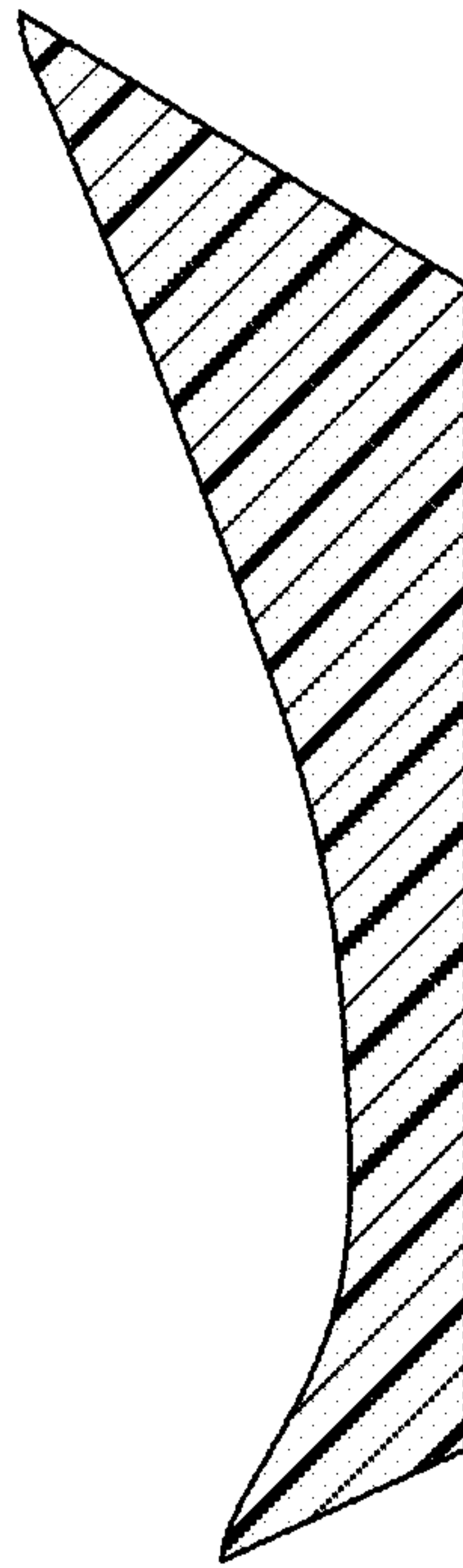

FIG. 25

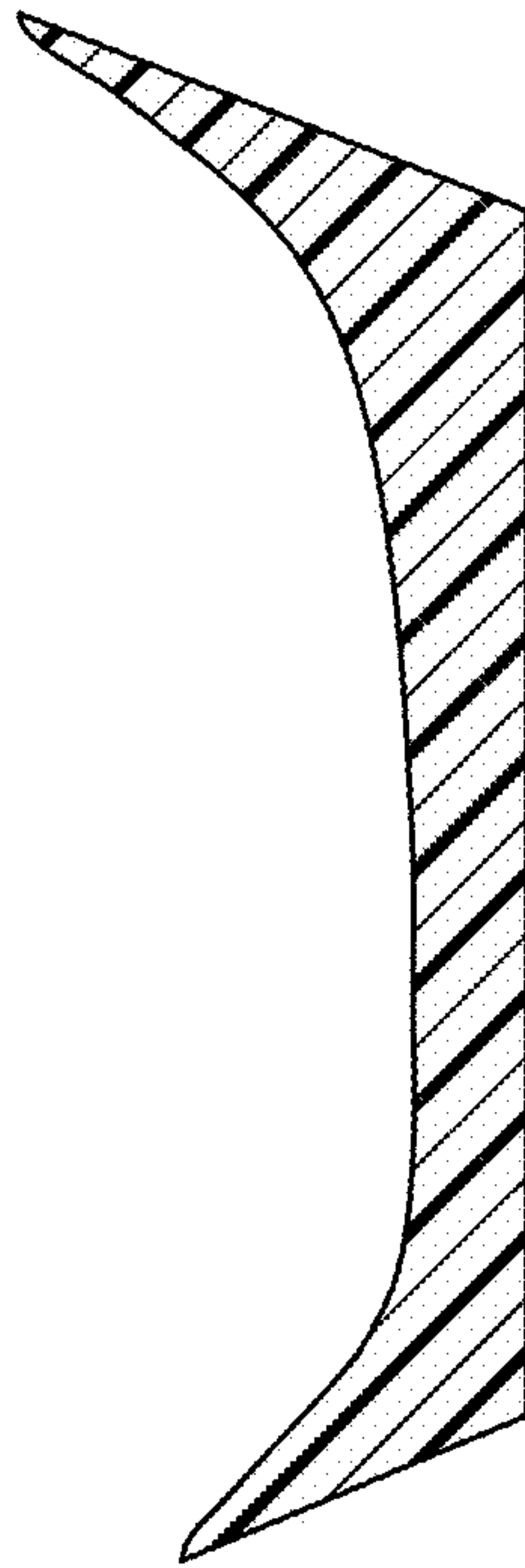

FIG. 26