



US00D985240S

(12) **United States Design Patent**
Wen

(10) **Patent No.:** **US D985,240 S**
(45) **Date of Patent:** **** May 9, 2023**

- (54) **HAT**
- (71) Applicant: **Guangzhou Xiaomeng Culture Communication Co., Ltd., Guangdong (CN)**
- (72) Inventor: **Qing Wen, Sichuan (CN)**
- (73) Assignee: **Guangzhou Xiaomeng Culture Communication Co., Ltd., Guangzhou (CN)**

(**) Term: **15 Years**

(21) Appl. No.: **29/868,545**

(22) Filed: **Dec. 6, 2022**

(51) **LOC (14) Cl.** **02-03**

(52) **U.S. Cl.**
USPC **D2/876**

(58) **Field of Classification Search**
USPC D2/865, 866, 875, 876, 877, 878, 879,
D2/880, 881, 882, 883, 884, 885, 886,
D2/887, 888, 891, 893
CPC A42B 1/00; A42B 1/002; A42B 1/004;
A42B 1/006; A42B 1/02; A42B 1/06;
A42B 1/201; A42B 1/225; A42C 5/04
See application file for complete search history.

(56) **References Cited**

U.S. PATENT DOCUMENTS

- 5,325,540 A * 7/1994 Kronenberger A42B 7/00
D2/896
- D458,737 S * 6/2002 Fuerst D2/892

- D525,414 S * 7/2006 Yan D2/876
- D702,928 S 4/2014 White
- D733,406 S 7/2015 Averahami
- D812,861 S * 3/2018 Mondrella D2/892
- D821,066 S * 6/2018 Mercado D2/876
- D917,135 S * 4/2021 Hickenbotham D2/882
- D919,242 S * 5/2021 MacIlwaine D2/876
- D941,560 S * 1/2022 Lin D2/882
- D972,814 S * 12/2022 Walker D2/876
- 2018/0325200 A1 * 11/2018 Tunison A42C 1/00
- 2020/0375532 A1 * 12/2020 Nath A61B 5/6803

OTHER PUBLICATIONS

US Trademark Application #97753363 for "OUC," filed on Jan. 13, 2023 by Guangzhou Xiaomeng Culture Communication Co., Ltd. First Use in Commerce date: Dec. 12, 2022. Retrieved from the internet on Mar. 19, 2023. (5 pages). (Year: 2022).*

* cited by examiner

Primary Examiner — Jasmine Mlinarcik

(57) **CLAIM**

The ornamental design for a hat, as shown and described.

DESCRIPTION

FIG. 1 is a top, back, right side perspective view of a hat, showing my new design;
 FIG. 2 is a bottom, back, right side perspective view thereof;
 FIG. 3 is a front elevational view thereof;
 FIG. 4 is a back elevational view thereof;
 FIG. 5 is a left side elevational view thereof;
 FIG. 6 is a right side elevational view thereof;
 FIG. 7 is a top plan view thereof; and,
 FIG. 8 is a bottom plan view thereof.

1 Claim, 8 Drawing Sheets

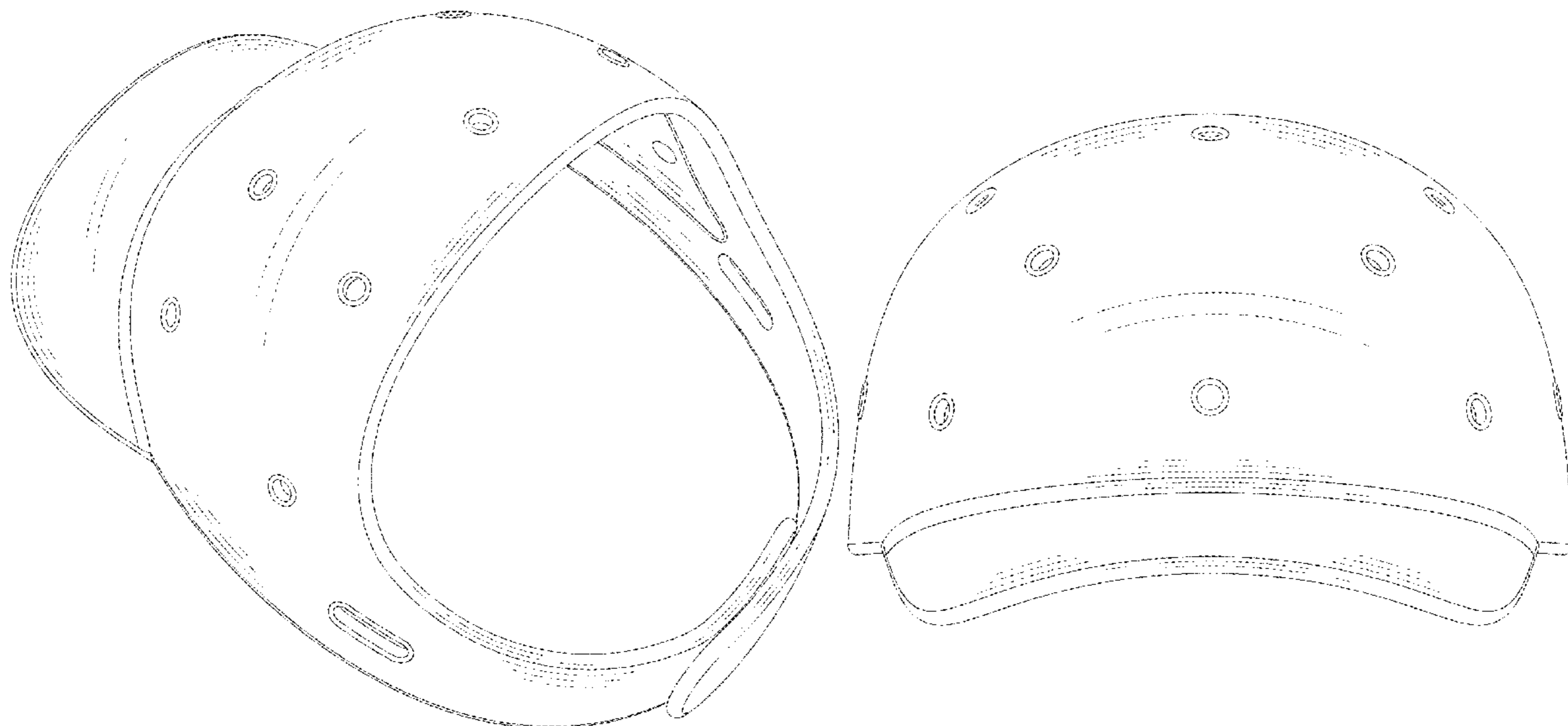

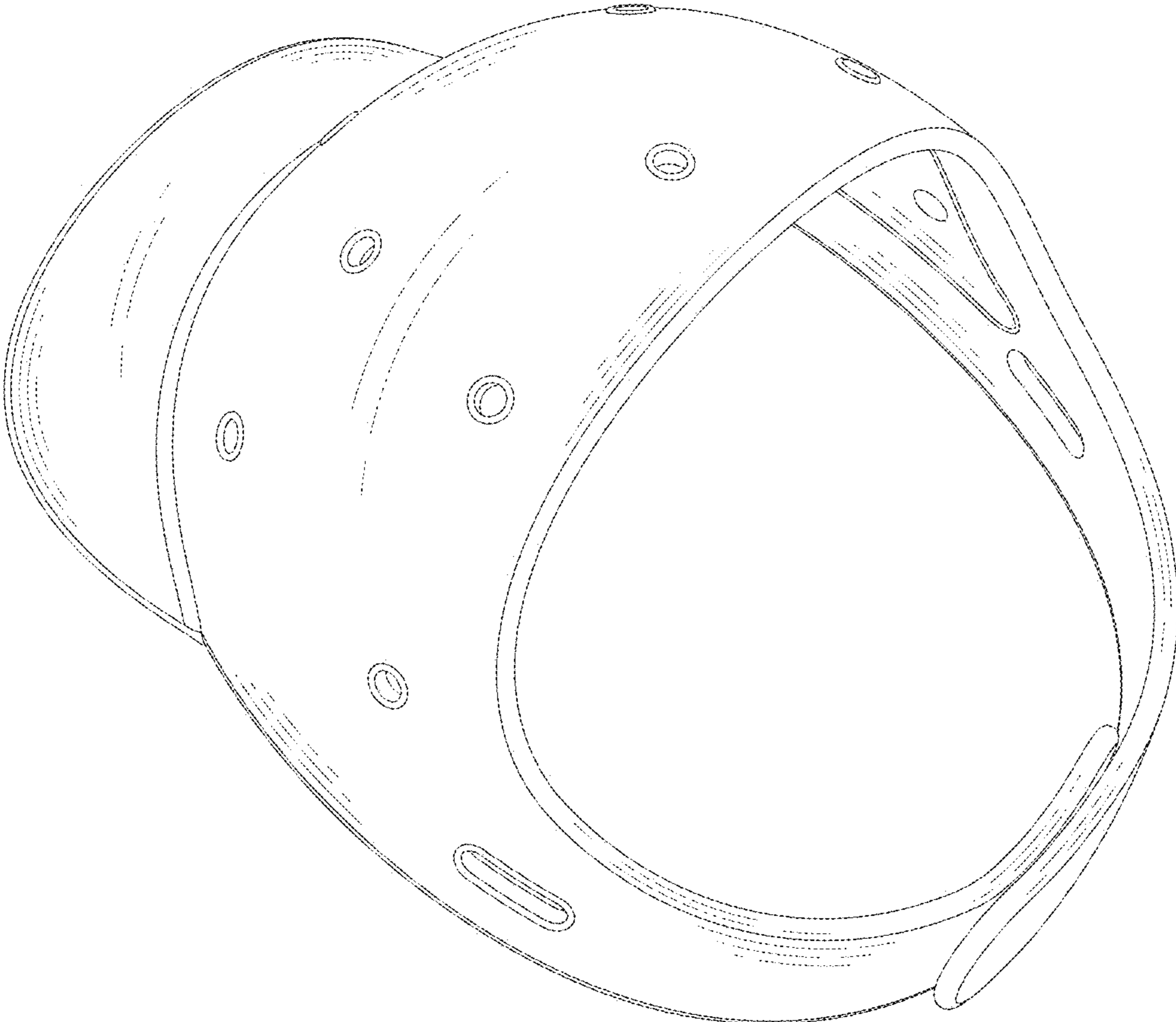

FIG. 1

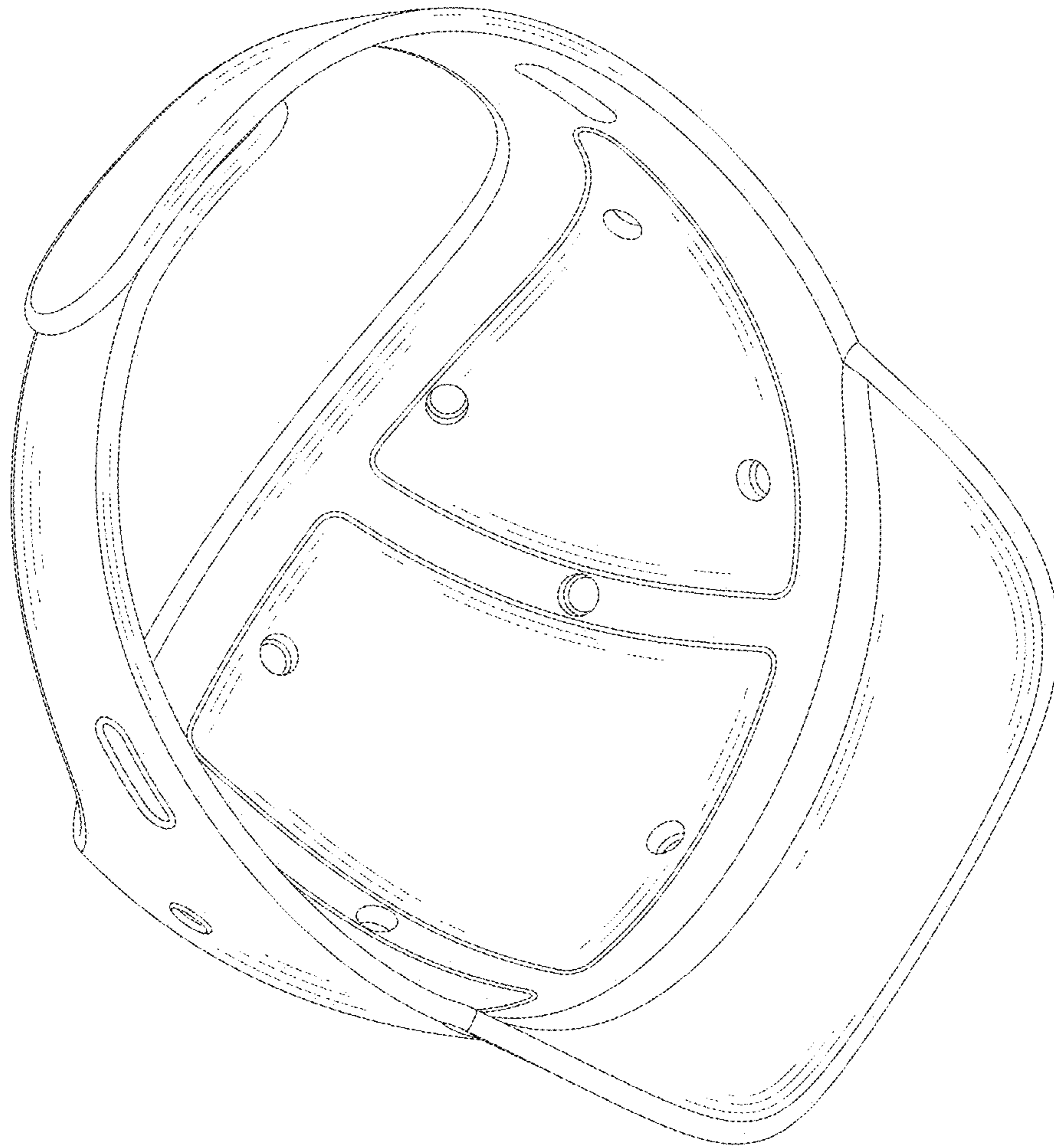

FIG. 2

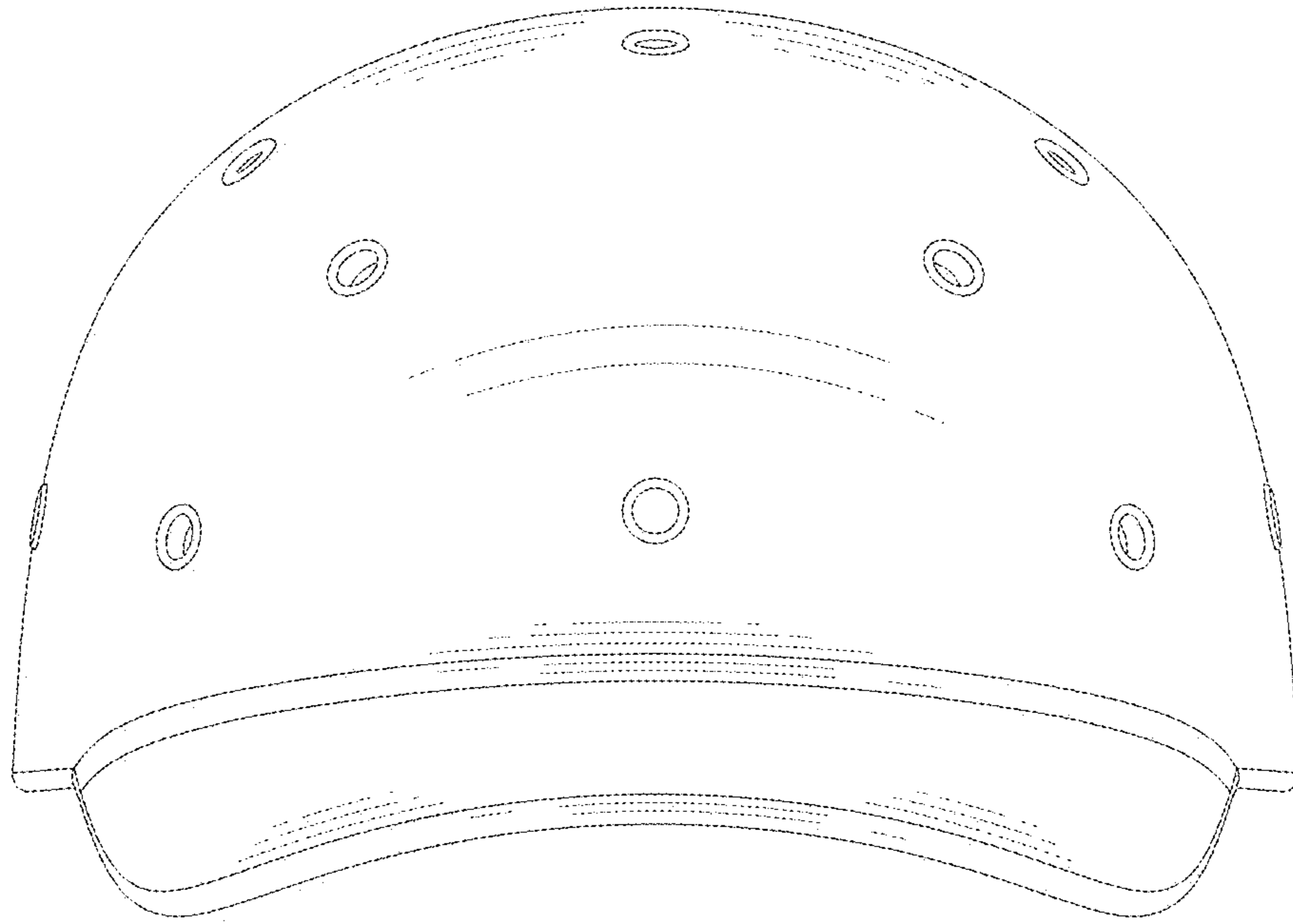

FIG. 3

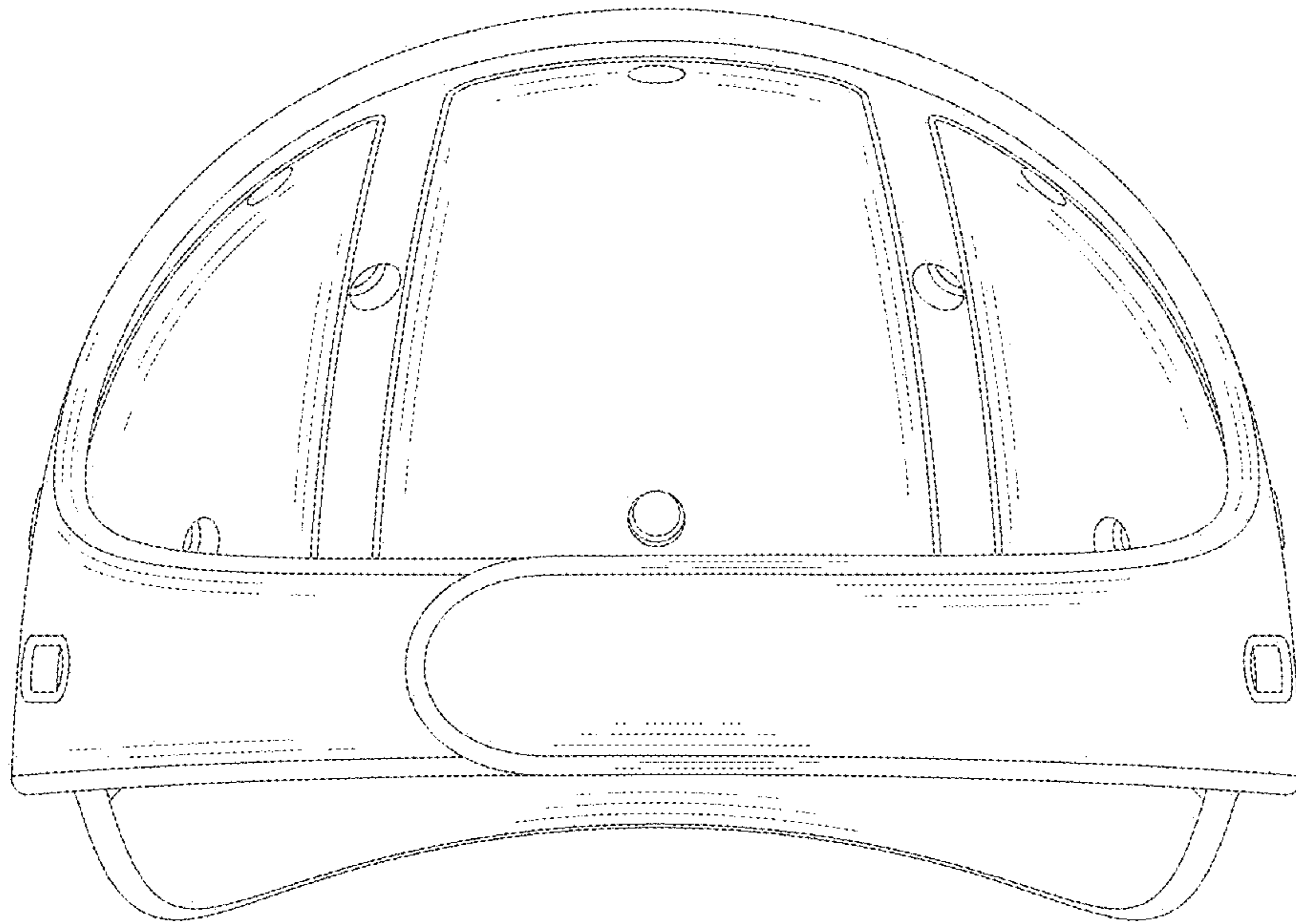

FIG. 4

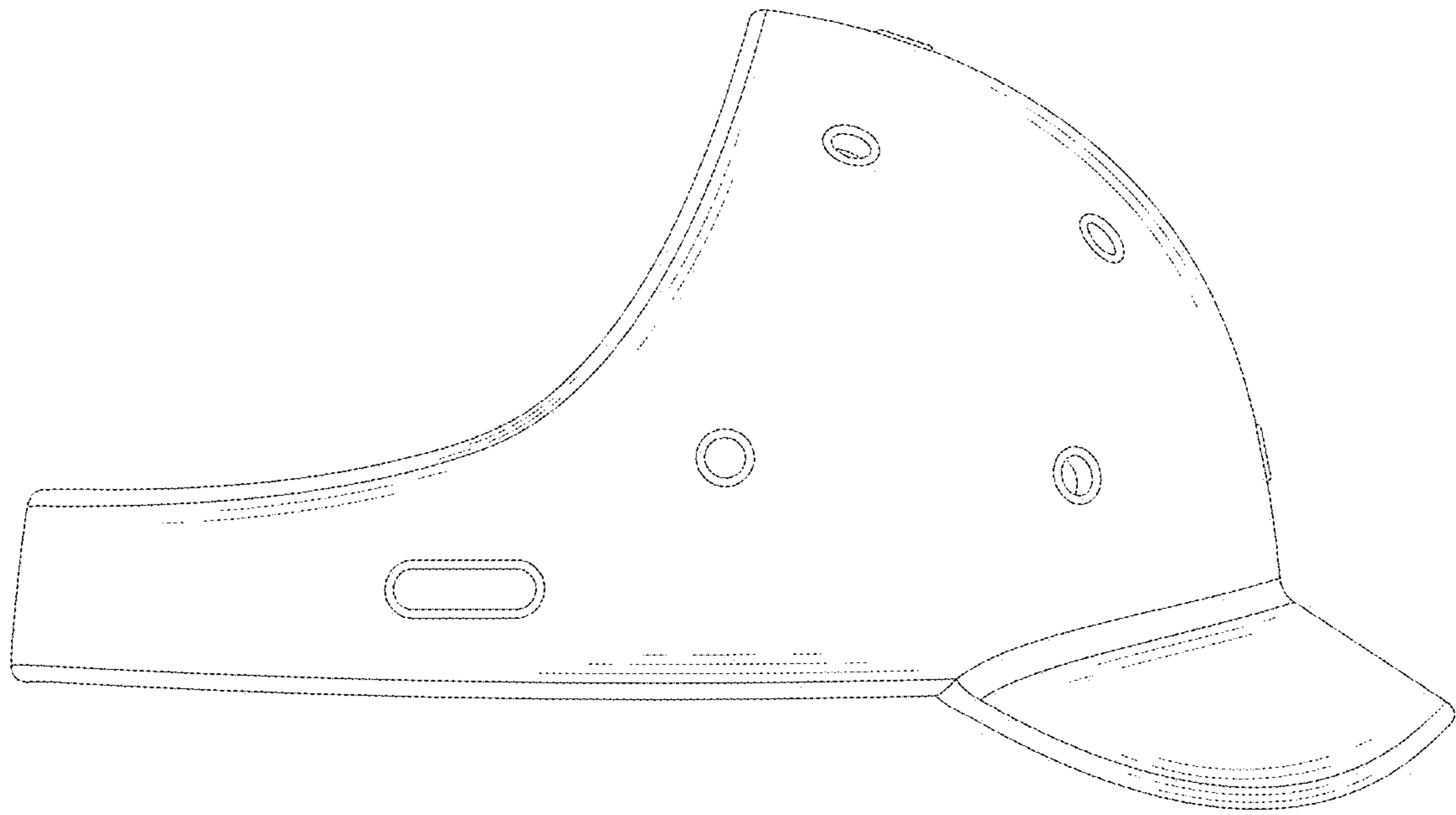

FIG. 5

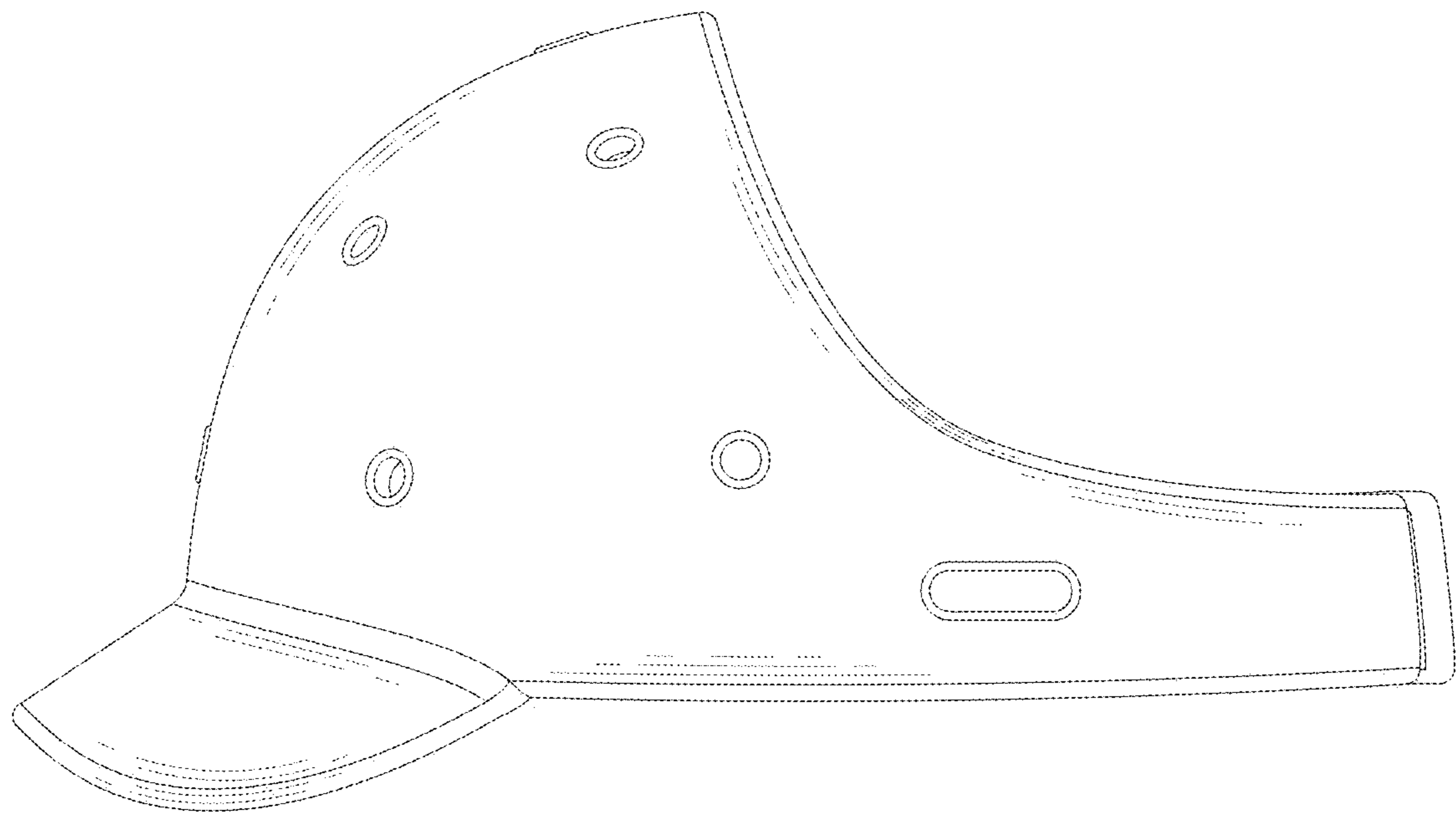

FIG. 6

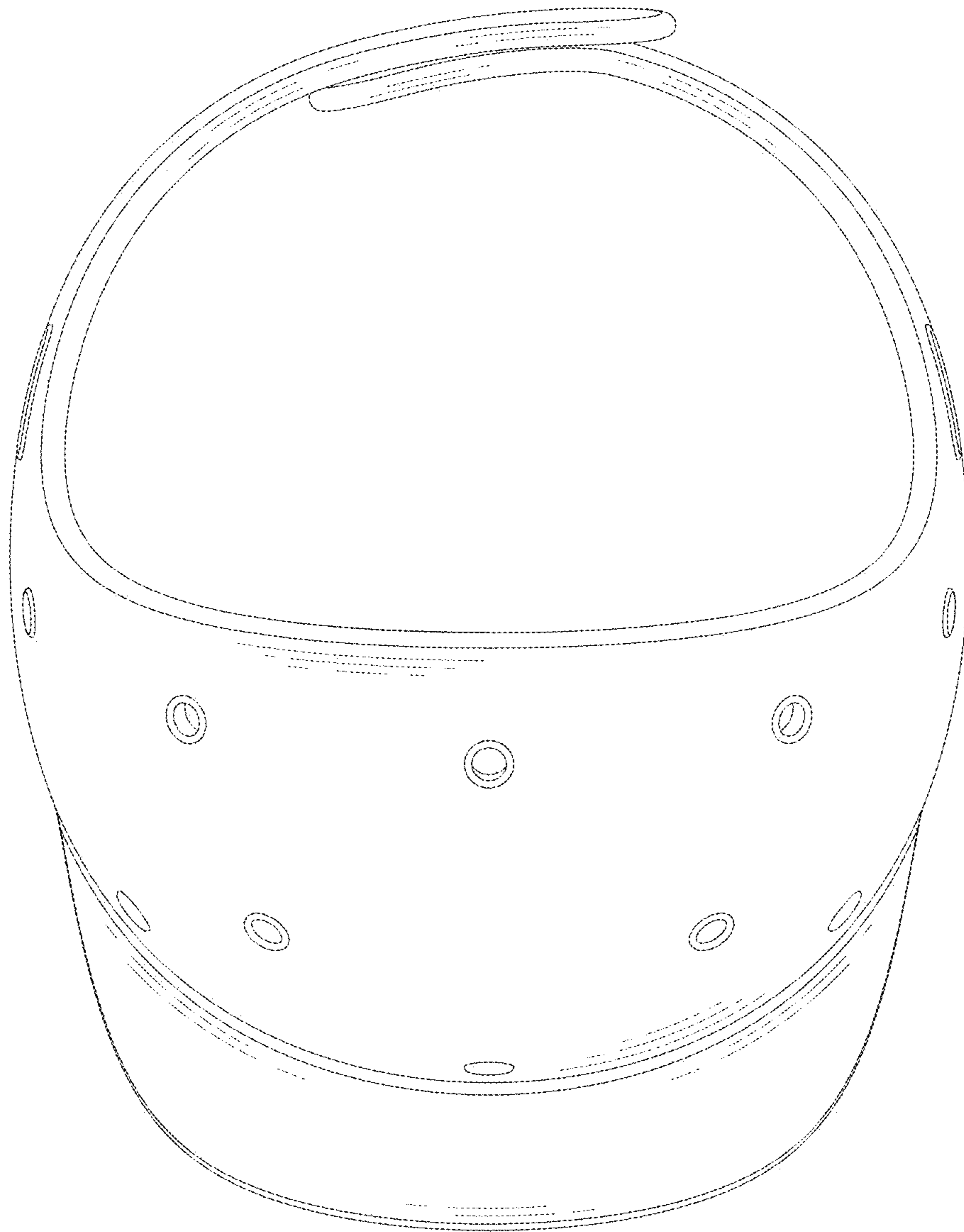

FIG. 7

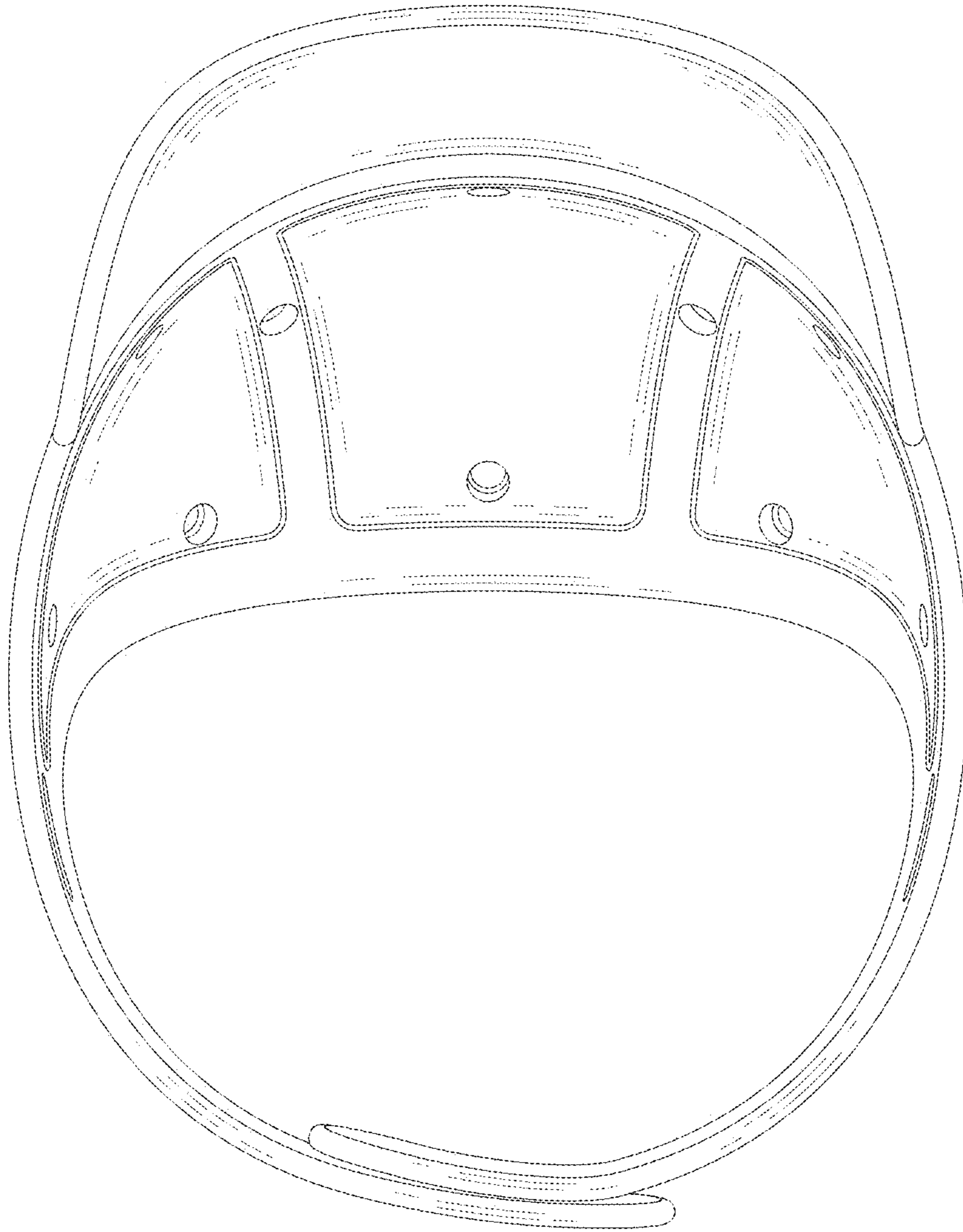

FIG. 8