



US00D985177S

(12) **United States Design Patent** (10) **Patent No.:** **US D985,177 S**
Browning (45) **Date of Patent:** **** May 2, 2023**

(54) **LAMP**

FOREIGN PATENT DOCUMENTS

(71) Applicant: **RH US, LLC**, Corte Madera, CA (US)

CN 305455009 * 11/2019
CN 305505926 * 12/2019

(72) Inventor: **John Richard Browning**, San Francisco, CA (US)

(Continued)

(73) Assignee: **RH US, LLC**, Corte Madera, CA (US)

OTHER PUBLICATIONS

(**) Term: **15 Years**

John Timberland LED Bollard Light, available in <https://www.amazon.com/>, posted: Aug. 11, 2020 [online], [site visited: Oct. 24, 2022], Internet URL: https://www.amazon.com/dp/B08FMT5CH9/ref=sspa_dk_detail_2?psc=1&pf_rd_p=25e96bbe-93d6-4790-9c18-ab0bc96db737&pf_rd_r=133GP0TJF2... (Year: 2020).*

(21) Appl. No.: **29/760,972**

(Continued)

(22) Filed: **Dec. 4, 2020**

(51) **LOC (14) Cl.** **26-05**

Primary Examiner — Sheryl Lane
Assistant Examiner — Alex T. Milbrath

(52) **U.S. Cl.**
USPC **D26/104**

(74) *Attorney, Agent, or Firm* — Lewis Roca Rothgerber Christie LLP

(58) **Field of Classification Search**
USPC D26/24, 51, 58, 63, 67-70, 93, 104, 105, D26/110, 112, 118; D25/126, 129; D10/111-114.9

(57) **CLAIM**

The ornamental design for a lamp, as shown and described.

CPC .. F21S 6/002; F21S 6/003; F21S 6/004; F21S 6/005; F21S 8/089; F21S 8/08; F21S 8/081; F21S 8/083; F21S 8/088; F21S 9/03; F21S 9/032; F21S 9/035; F21S 9/037; F21V 7/041; F21V 21/06; F21V 21/0824; F21W 2131/109; F21W 2111/023
See application file for complete search history.

DESCRIPTION

FIG. 1 is a perspective view of a first embodiment of a lamp showing my new design;
FIG. 2 is a top plan view thereof;
FIG. 3 is a front view thereof, the left and right side views being identical;
FIG. 4 is a rear view thereof;
FIG. 5 is a perspective view of a second embodiment of a lamp showing my new design;
FIG. 6 is a top plan view thereof;
FIG. 7 is a front view thereof, the left and right side views being identical; and,
FIG. 8 is a rear view thereof.
FIGS. 5, 7, and 8 include break lines and those portions of the article between the break lines form no part of the claimed design. The short broken lines represent environmental subject matter and form no part of the claimed design.

(56) **References Cited**

U.S. PATENT DOCUMENTS

D84,077 S * 5/1931 Graff D26/104
D113,034 S * 1/1939 Clark D26/104
D377,229 S * 1/1997 Shalvi D26/68
D485,004 S * 1/2004 Olson D26/104
D600,396 S * 9/2009 Luinstra D26/104
D611,646 S * 3/2010 Swanson D26/104
D660,492 S * 5/2012 Williams D26/68

(Continued)

1 Claim, 4 Drawing Sheets

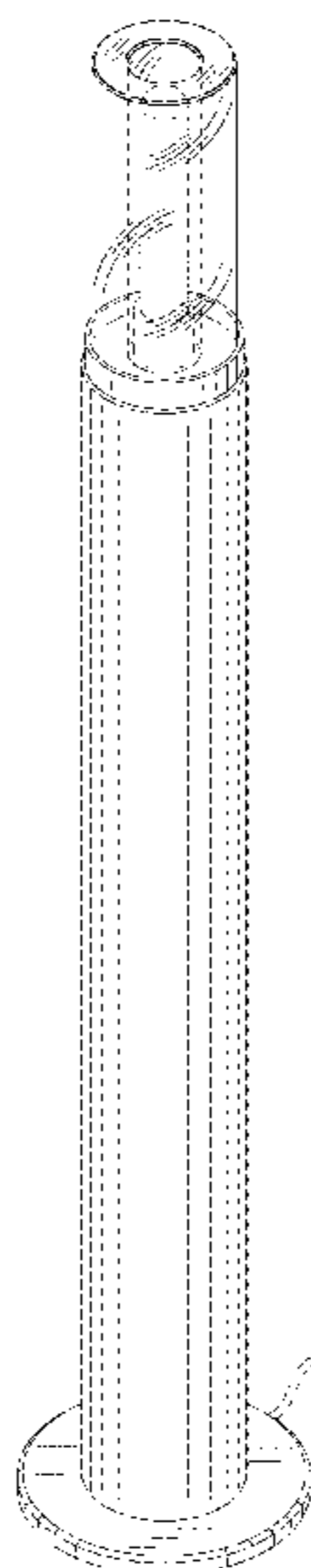

(56)

References Cited

U.S. PATENT DOCUMENTS

D778,480 S * 2/2017 Galloppa D26/68
D903,929 S * 12/2020 Gillespie D26/106

FOREIGN PATENT DOCUMENTS

CN 305691771 * 4/2020
CN 307304234 * 4/2022

OTHER PUBLICATIONS

Illumishin Outdoor Pathway Light, available in <https://www.amazon.com/>, posted: Feb. 28, 2022 [online], [site visited: Oct. 24, 2022], Internet URL: [https://www.amazon.com/dp/B09TKMMDWS/ref=sspa_dk_detail_6?pf_rd_p=bff6e147-54ad-4be3-b4ea-ec19ea6167f7&pf_rd_r=WAPSYRG0NQDN5 . . .](https://www.amazon.com/dp/B09TKMMDWS/ref=sspa_dk_detail_6?pf_rd_p=bff6e147-54ad-4be3-b4ea-ec19ea6167f7&pf_rd_r=WAPSYRG0NQDN5...) (Year: 2022).*

Harrrrd LED Bollard Landscape Lights, available in <https://www.amazon.com/>, posted: Sep. 2, 2020 [online], [site visited: Oct. 24, 2022], Internet URL: [https://www.amazon.com/Landscape-Commercial-Residential-Driveway-Locations/dp/B08HG24ZB8/ref=asc_df_B08HG24ZB8/?tag=hyprod-20&linkC . . .](https://www.amazon.com/Landscape-Commercial-Residential-Driveway-Locations/dp/B08HG24ZB8/ref=asc_df_B08HG24ZB8/?tag=hyprod-20&linkC...) (Year: 2020).*

Solus Bollard Light, available in <https://www.amazon.com/>, posted: May 5, 2021 [online], [site visited: Oct. 24, 2022], Internet URL: https://www.amazon.com/dp/B094866HRL/ref=emc_b_5_t (Year: 2021).*

CGC Dark Grey Outdoor Bollard Post Light, available in <https://www.amazon.co.uk/>, posted: Mar. 21, 2020 [online], [site visited: Nov. 17, 2022], Internet URL: <https://www.amazon.co.uk/CGC-Anthracite-Standard-Lampholder-Contemporary/dp/B08DD3J9ZM/ref> (Year: 2020).*

* cited by examiner

FIG. 1

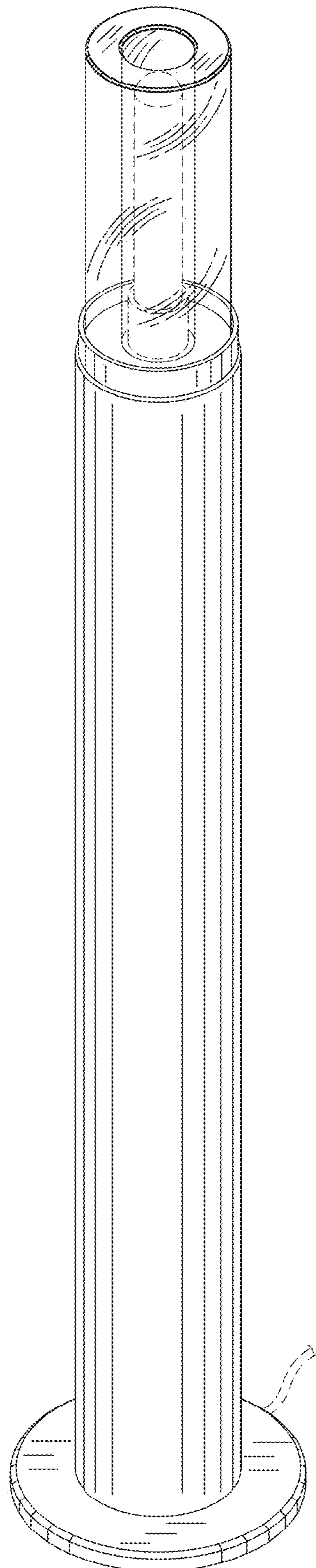

FIG. 2

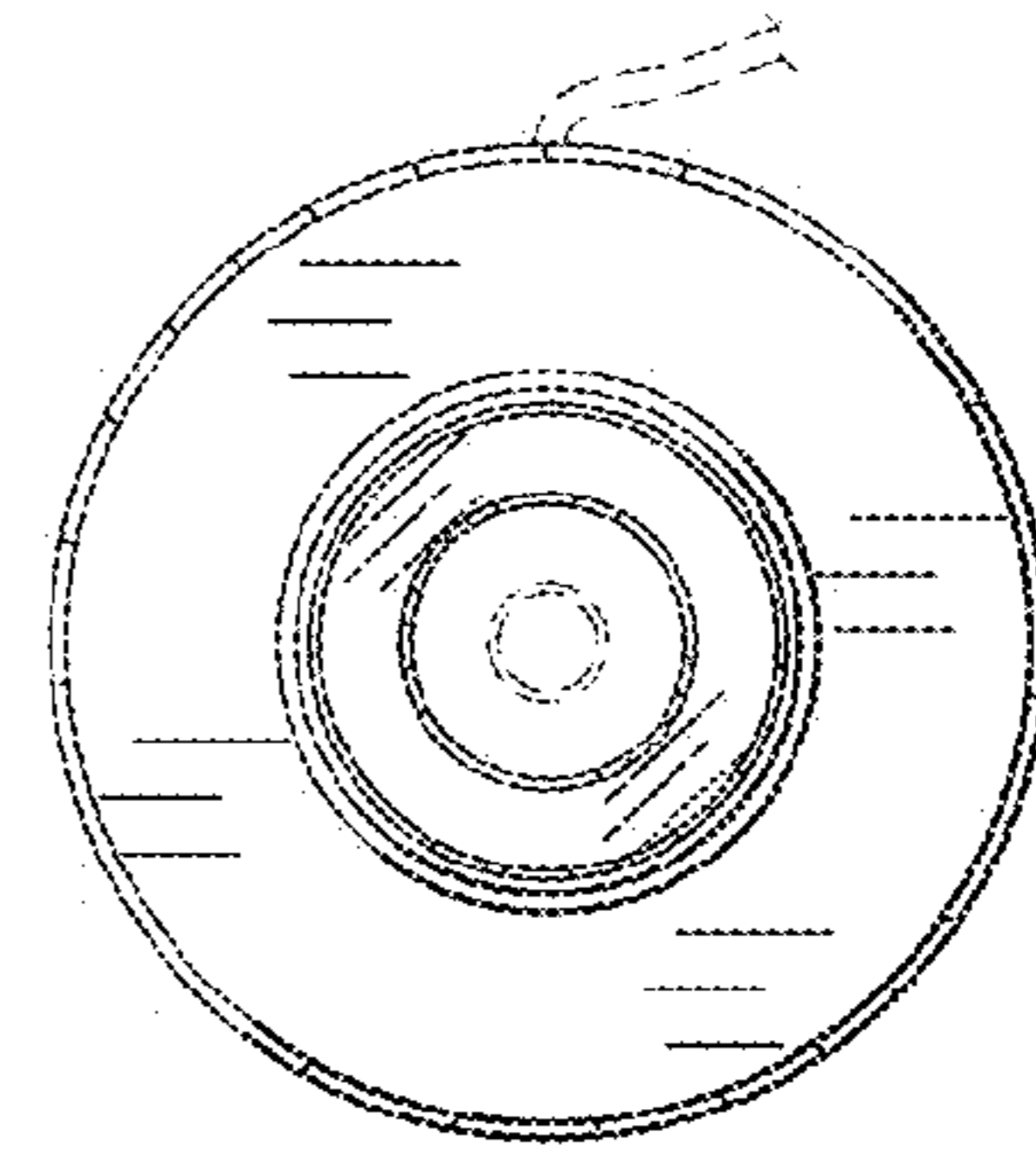

FIG. 3

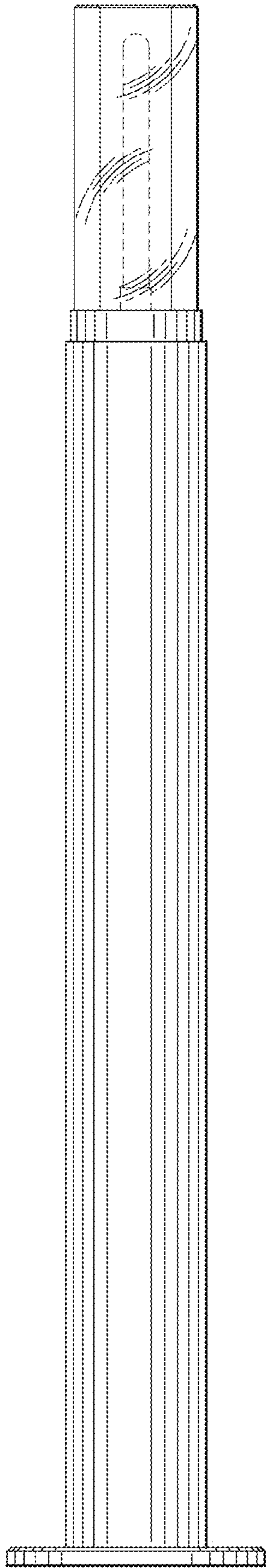

FIG. 4

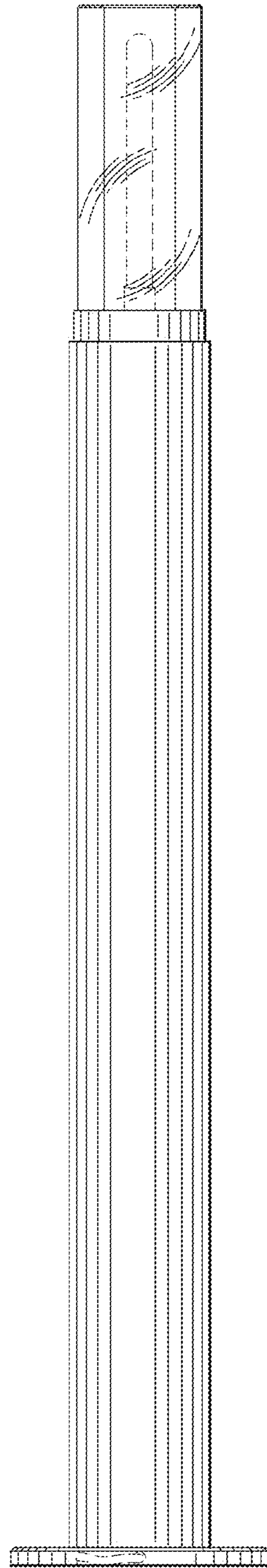

FIG. 5

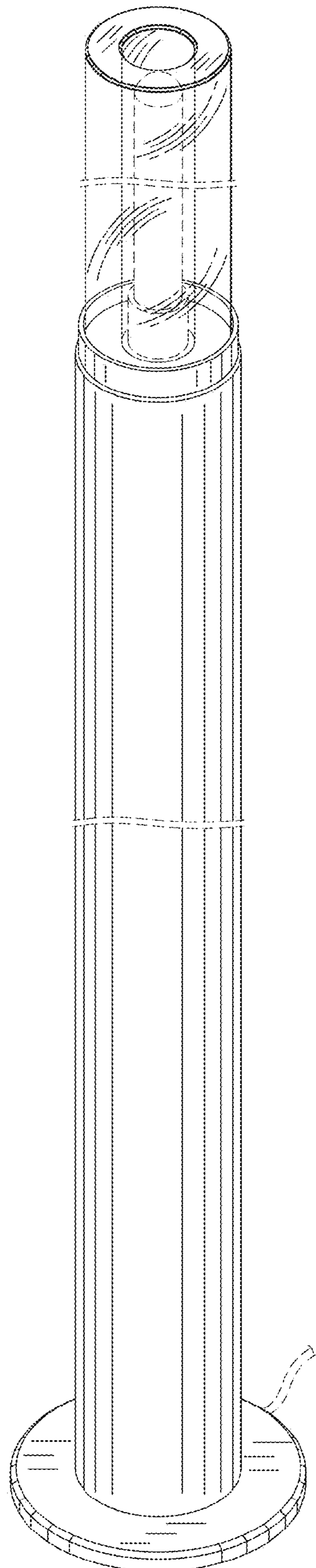

FIG. 6

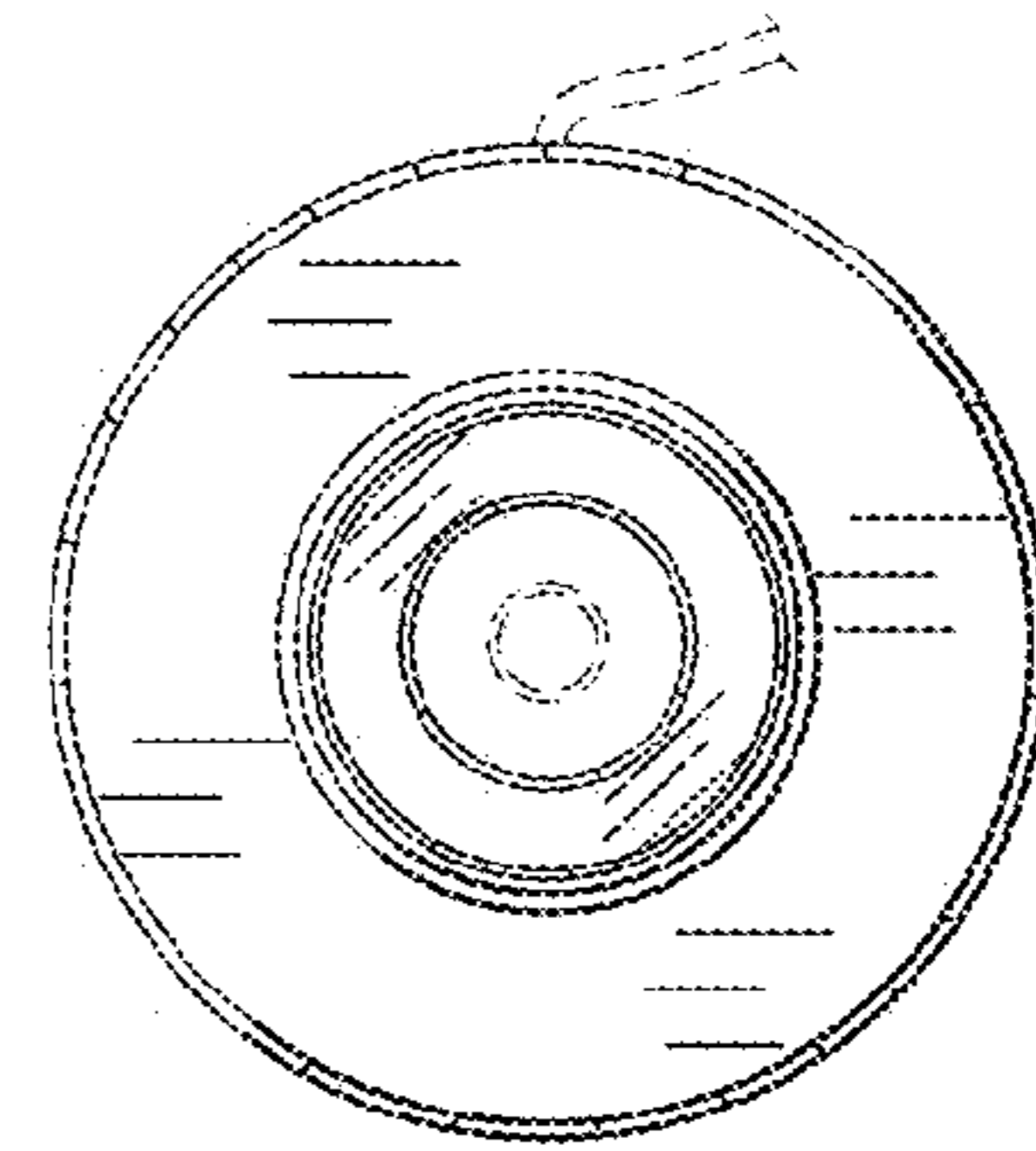

FIG. 7

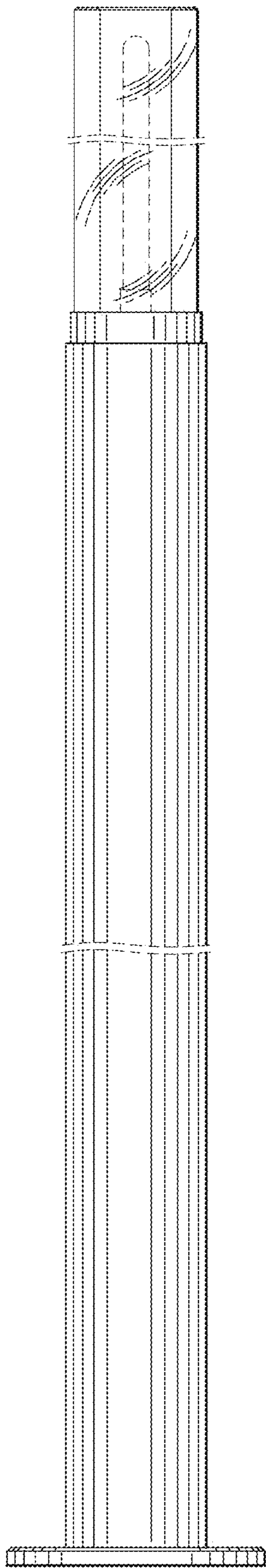

FIG. 8

