



US00D985124S

(12) **United States Design Patent**
Umebayashi

(10) **Patent No.:** **US D985,124 S**

(45) **Date of Patent:** **** May 2, 2023**

(54) **DIAPER**

(71) Applicant: **ZUIKO CORPORATION**, Osaka (JP)

(72) Inventor: **Toyoshi Umebayashi**, Osaka (JP)

(73) Assignee: **ZUIKO CORPORATION**, Osaka (JP)

(**) Term: **15 Years**

(21) Appl. No.: **35/512,935**

(22) Filed: **May 17, 2021**

(80) **Hague Agreement Data**

Int. Filing Date: **May 17, 2021**

Int. Reg. No.: **DM/215942**

Int. Reg. Date: **May 17, 2021**

Int. Reg. Pub. Date: **Nov. 19, 2021**

(30) **Foreign Application Priority Data**

Nov. 25, 2020 (JP) 2020-025402D

(51) **LOC (14) Cl.** **02-01**

(52) **U.S. Cl.**
USPC **D24/126**

(58) **Field of Classification Search**

USPC D24/124, 125, 126, 189, 190, 191, 192

CPC A61F 13/15; A61F 13/64; A61F 13/476;
A61F 13/5611; A61F 13/4704

See application file for complete search history.

(56) **References Cited**

U.S. PATENT DOCUMENTS

D577,119 S	9/2008	Kawakami et al.	
D733,872 S *	7/2015	Beck	D24/126
D782,663 S *	3/2017	Morimoto	D24/126
D805,191 S *	12/2017	Yamada	D24/126
D882,769 S *	4/2020	Hirsch	D24/124
D902,396 S *	11/2020	Yamada	D24/126

D902,397 S *	11/2020	Yamada	D24/126
D933,818 S *	10/2021	Smet	D24/126
D960,376 S *	8/2022	Karpman	D24/189

FOREIGN PATENT DOCUMENTS

JP	1260685 S	1/2006
JP	1260686 S	1/2006
JP	1261098 S	1/2006
JP	1261099 S	1/2006
JP	1261100 S	1/2006
JP	1261101 S	1/2006
JP	1261102 S	1/2006
JP	1261103 S	1/2006

* cited by examiner

Primary Examiner — Samantha Q Lawrence

(74) *Attorney, Agent, or Firm* — The Webb Law Firm

(57) **CLAIM**

The ornamental design for a diaper, as shown and described.

DESCRIPTION

FIG. 1.1 is a front view of a diaper showing my new design;

FIG. 1.2 is back view thereof;

FIG. 1.3 is a top view thereof;

FIG. 1.4 is a bottom view thereof;

FIG. 1.5 is a right side view thereof;

FIG. 1.6 is a left side view thereof;

FIG. 1.7 is a perspective view thereof;

FIG. 1.8 is a perspective view thereof;

FIG. 1.9 is a front view thereof;

FIG. 1.10 is back view thereof;

FIG. 1.11 is a top view thereof;

FIG. 1.12 is a bottom view thereof;

FIG. 1.13 is a right side view thereof;

FIG. 1.14 is a left side view thereof; and

FIG. 1.15 is a front view thereof.

The broken lines shown in FIGS. 1.1-1.15 illustrate environment and form no part of the claimed design.

1 Claim, 15 Drawing Sheets

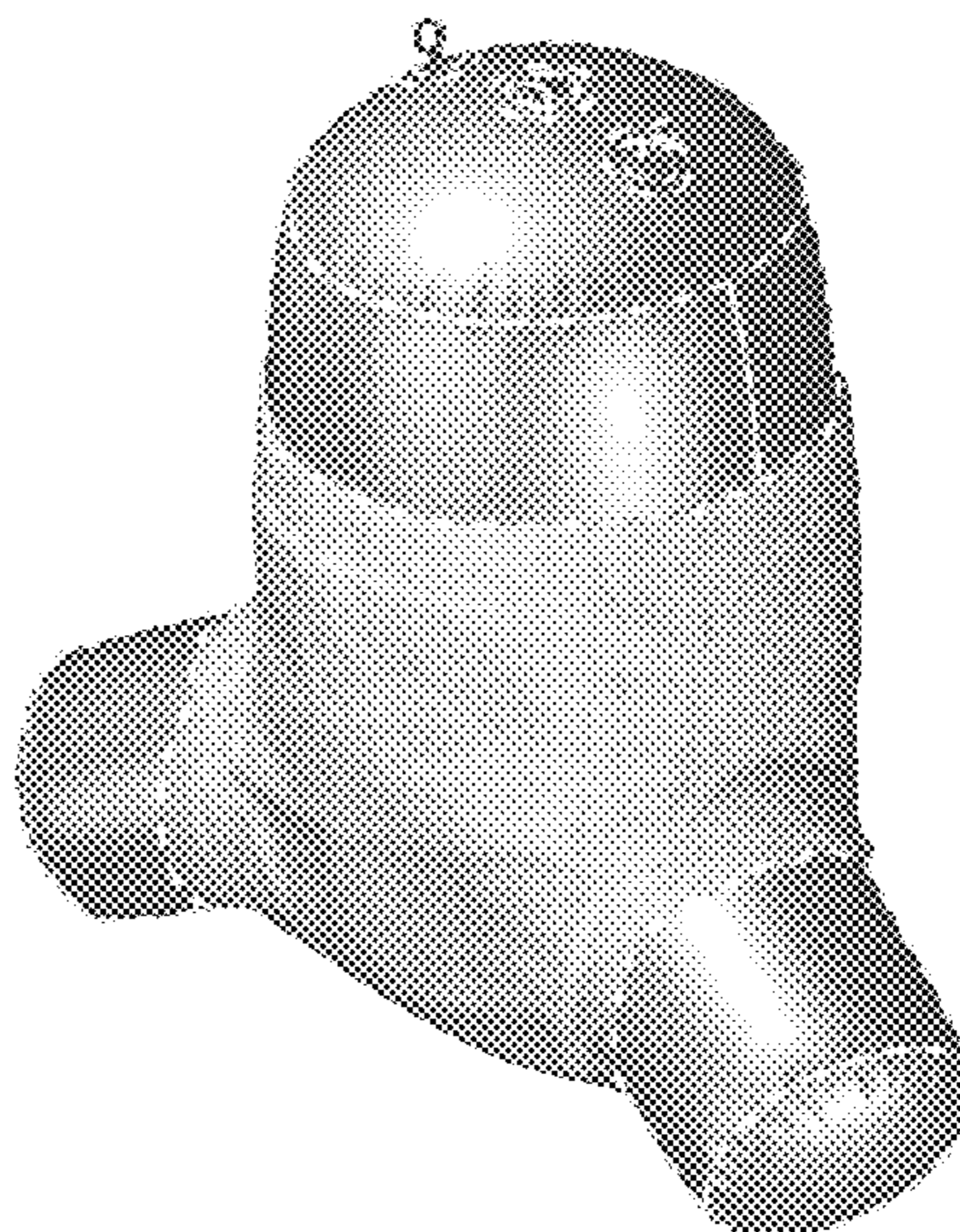
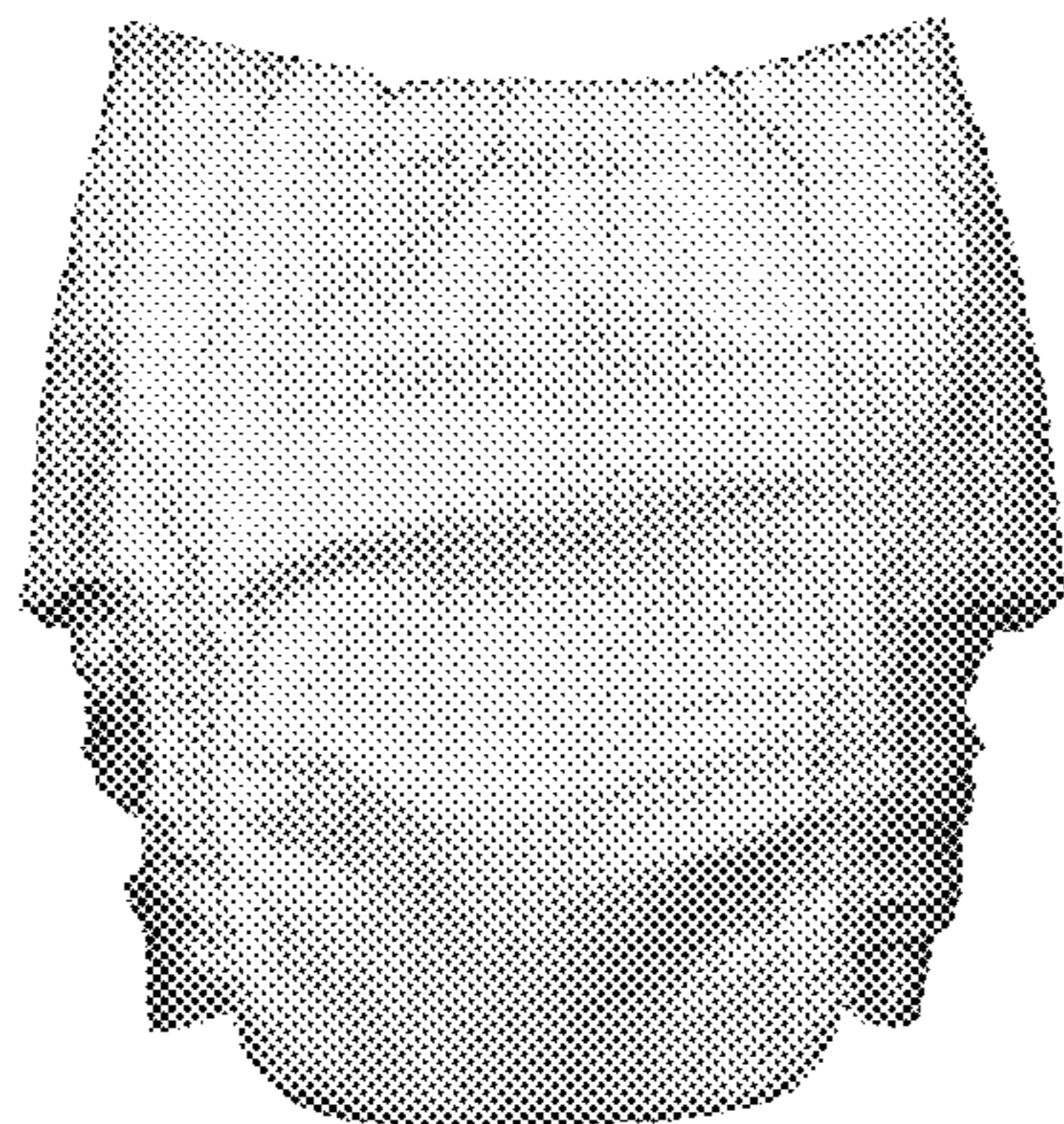

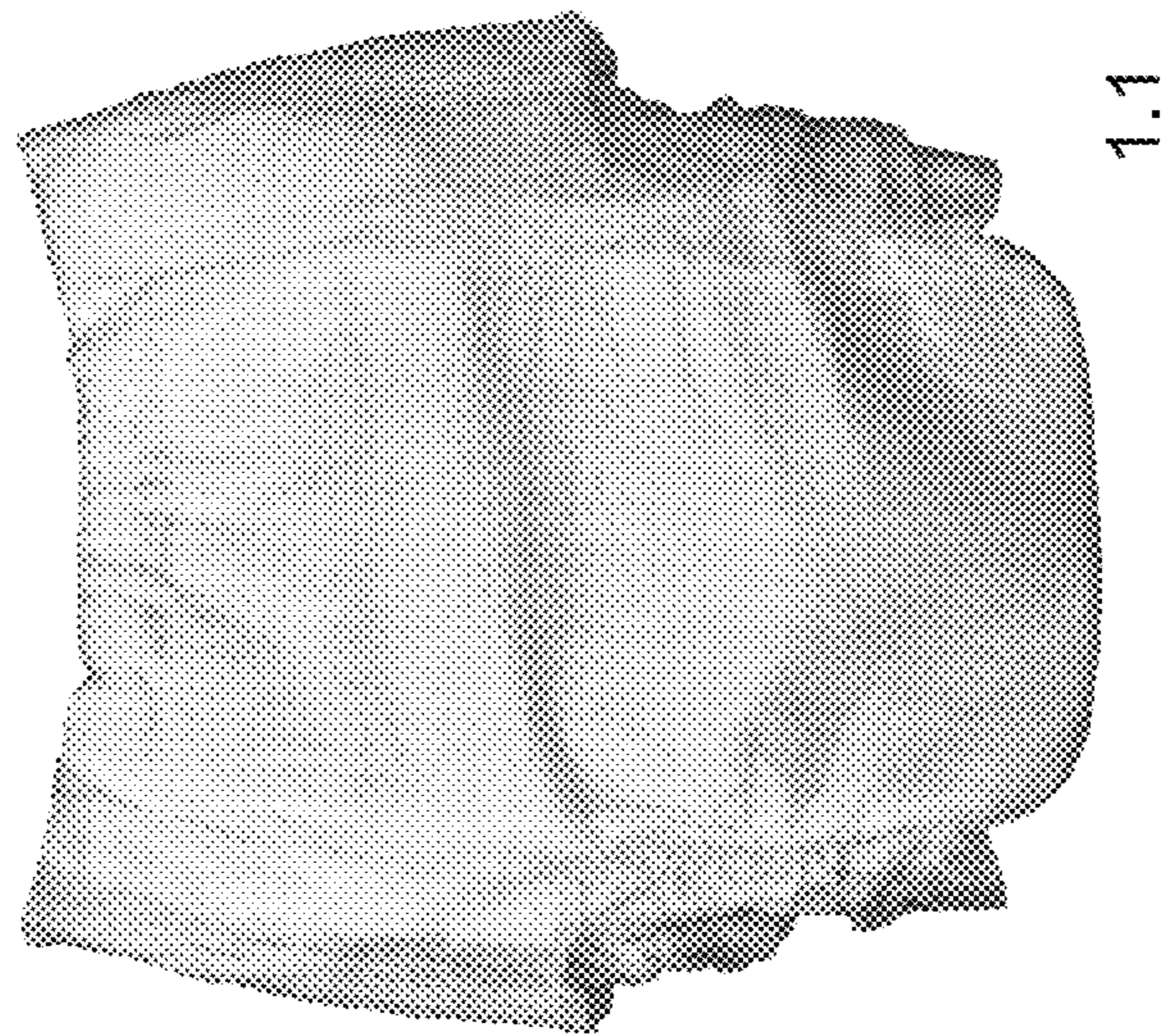

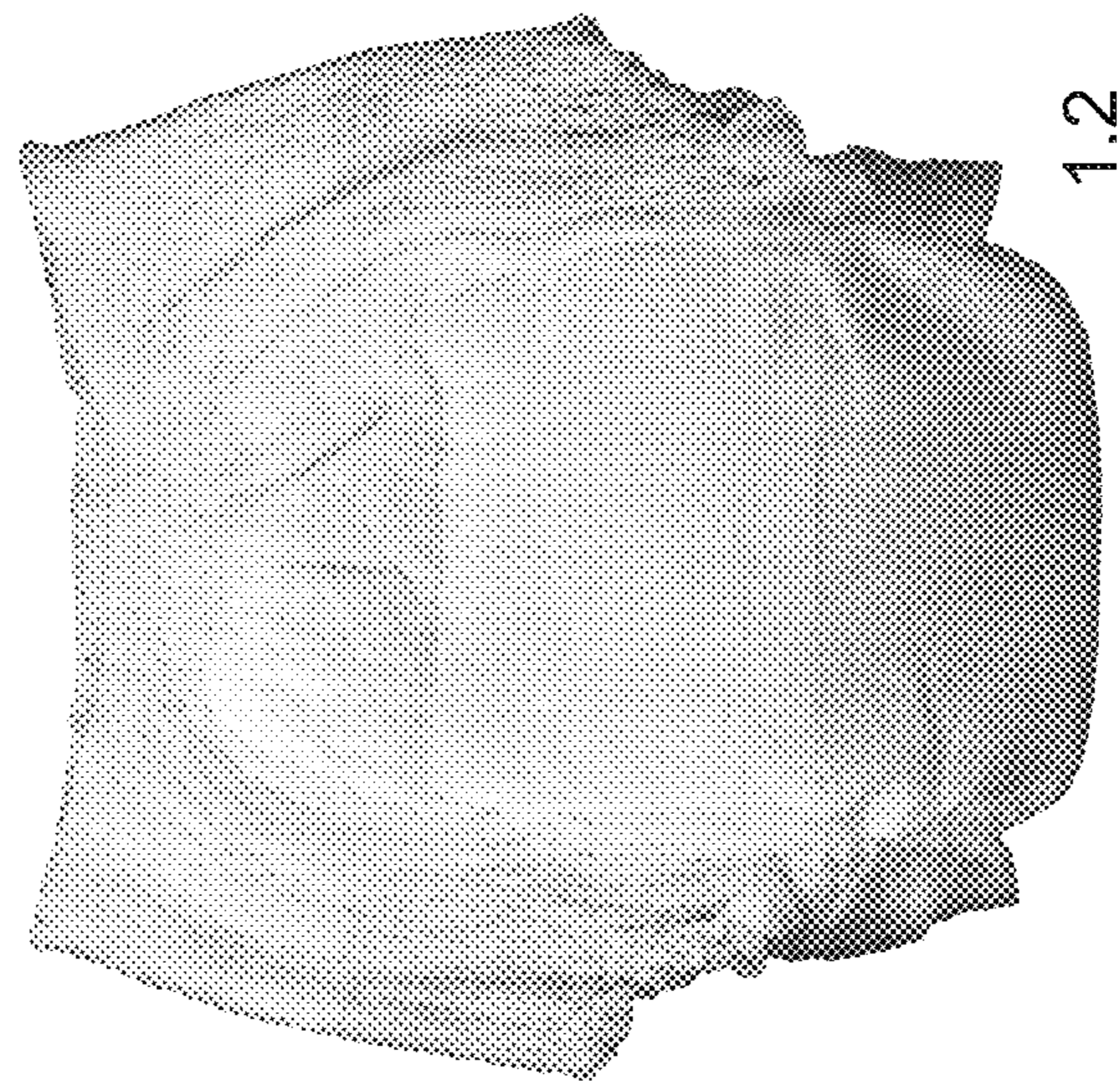

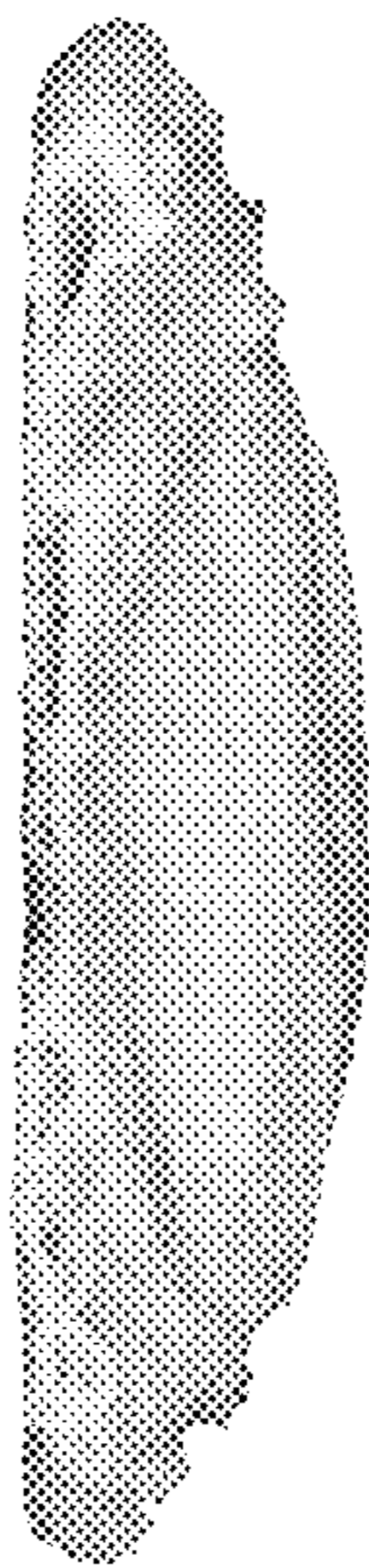

1.3

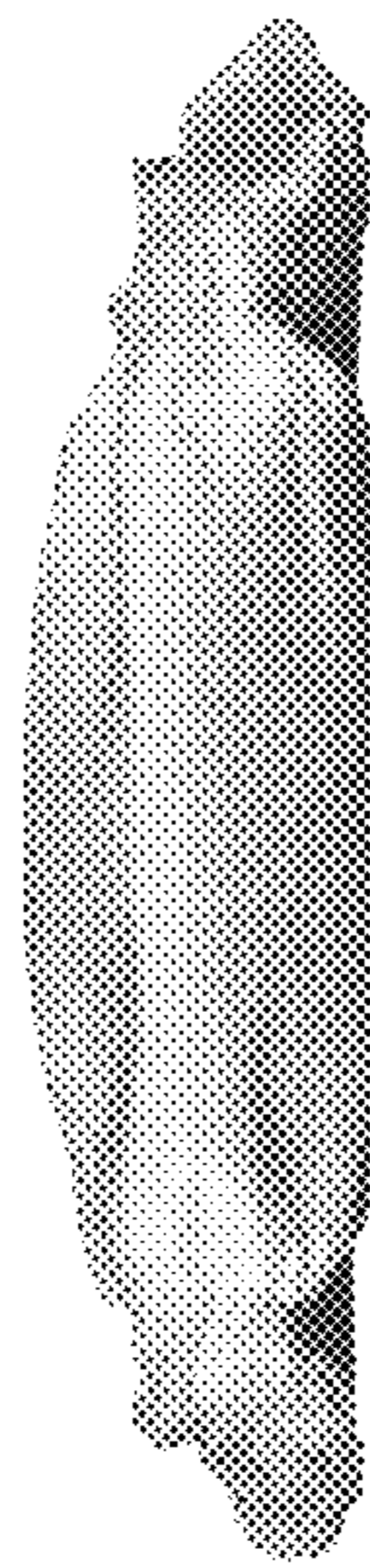

1.4

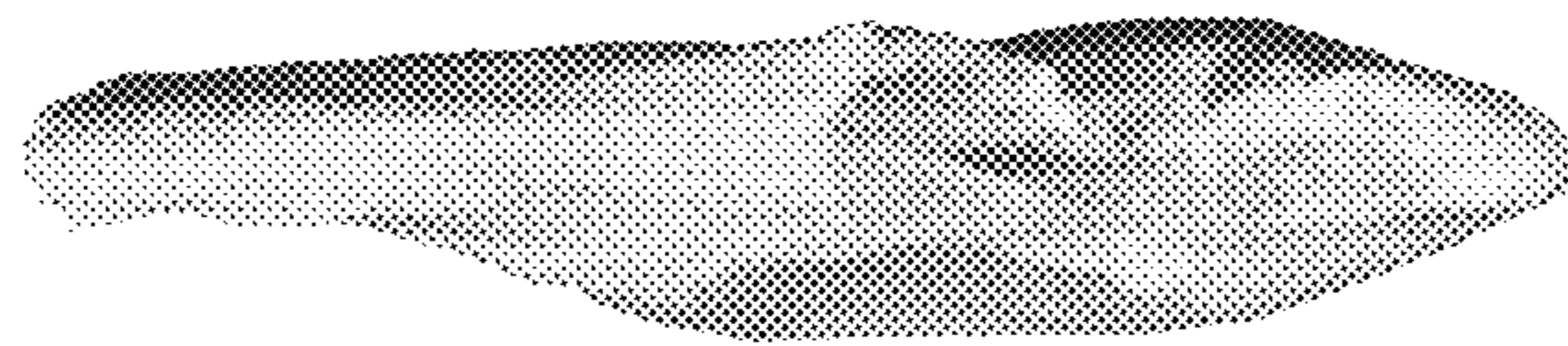

1.5

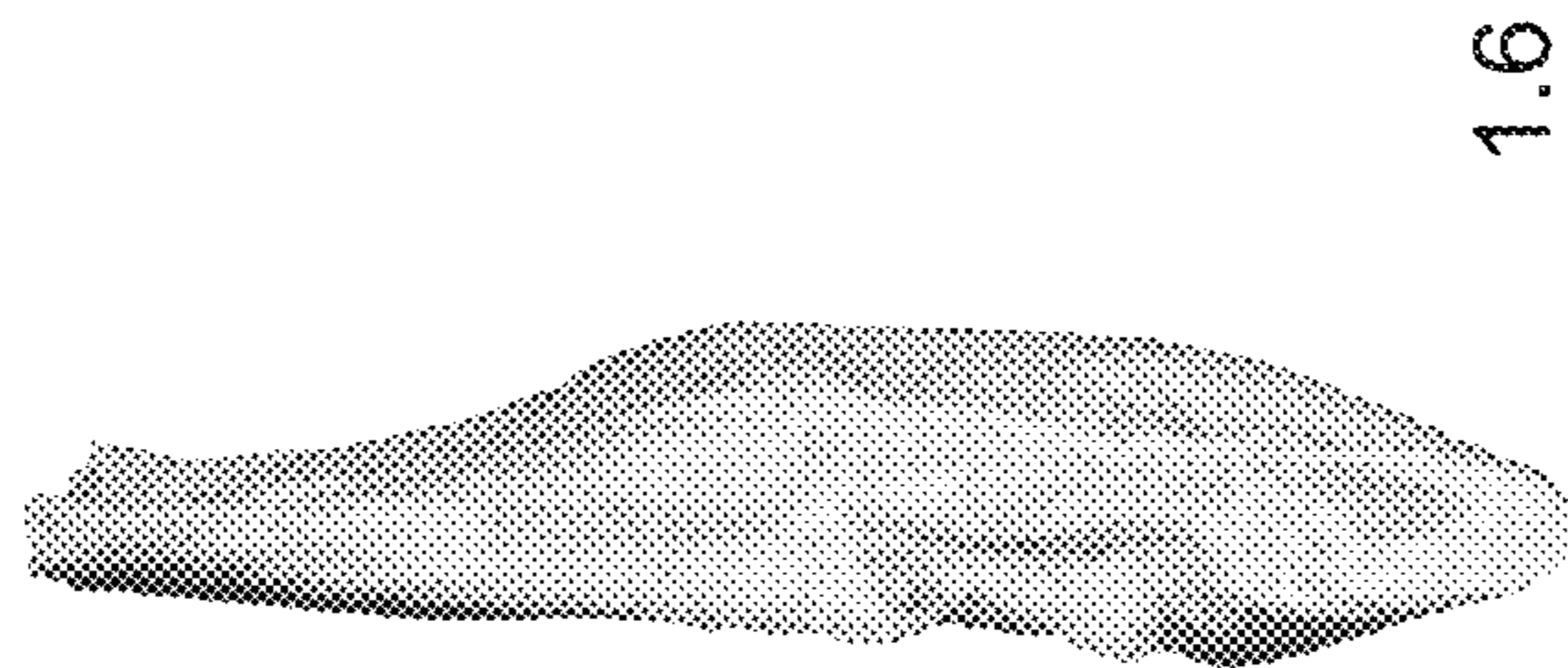

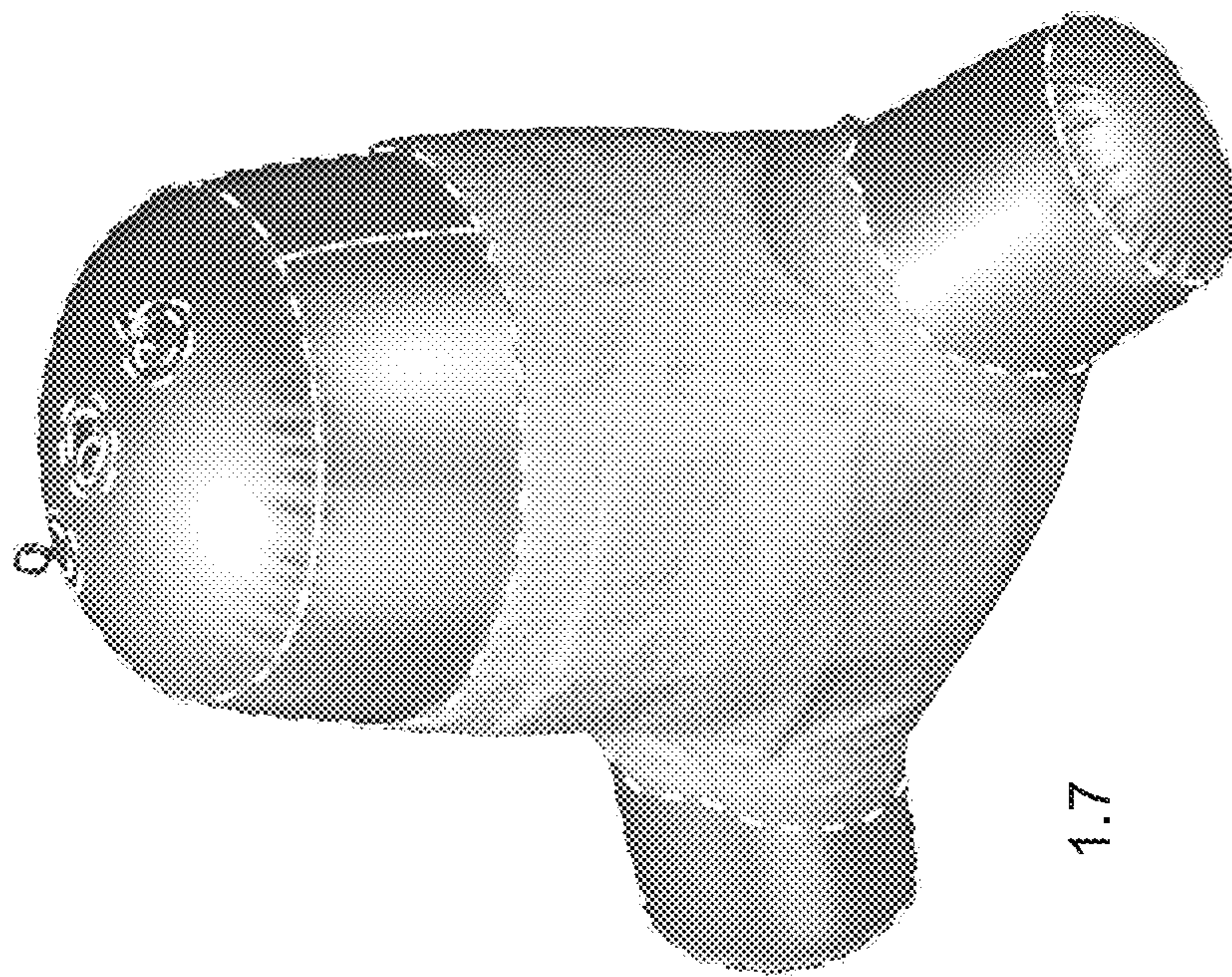

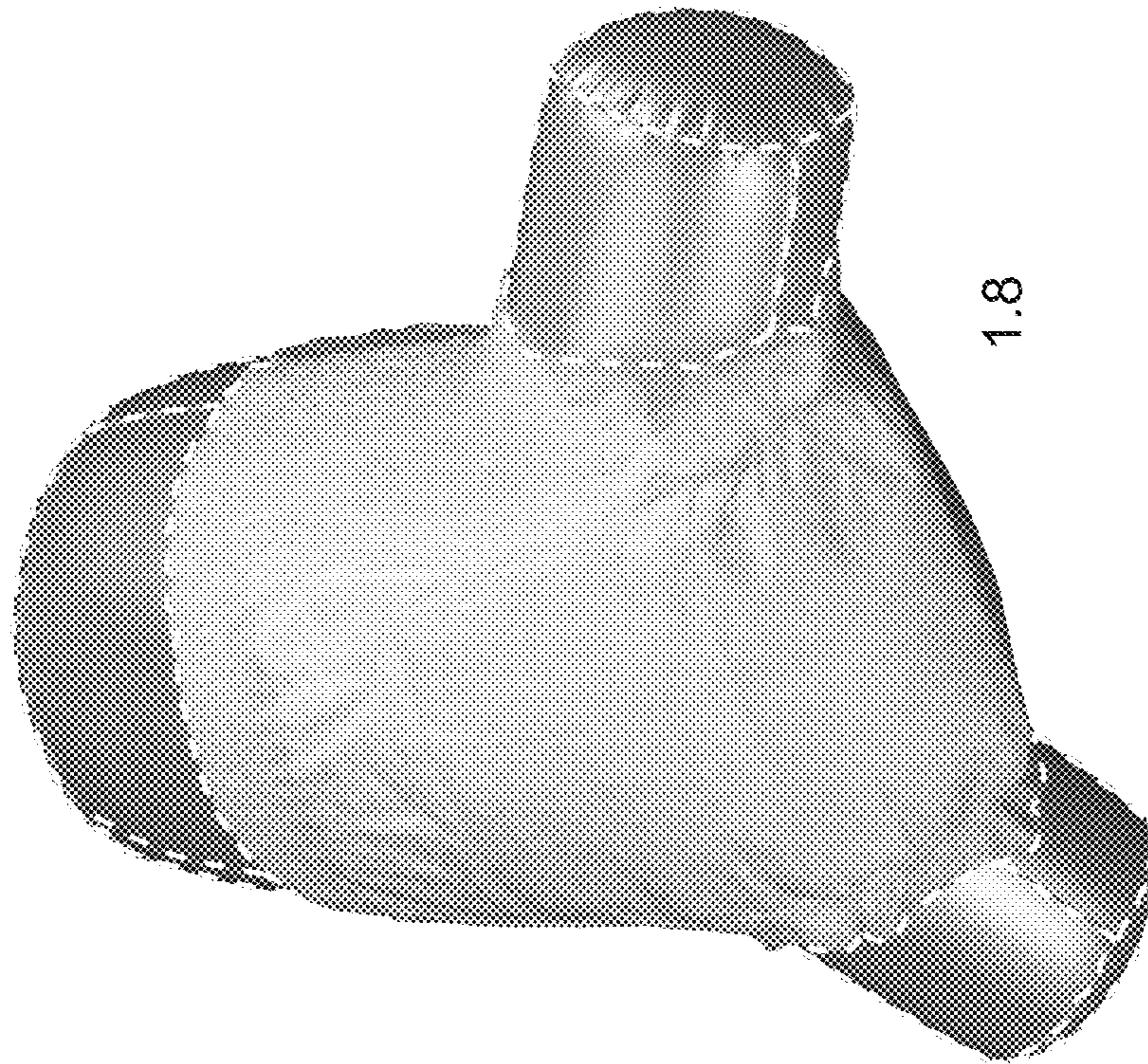

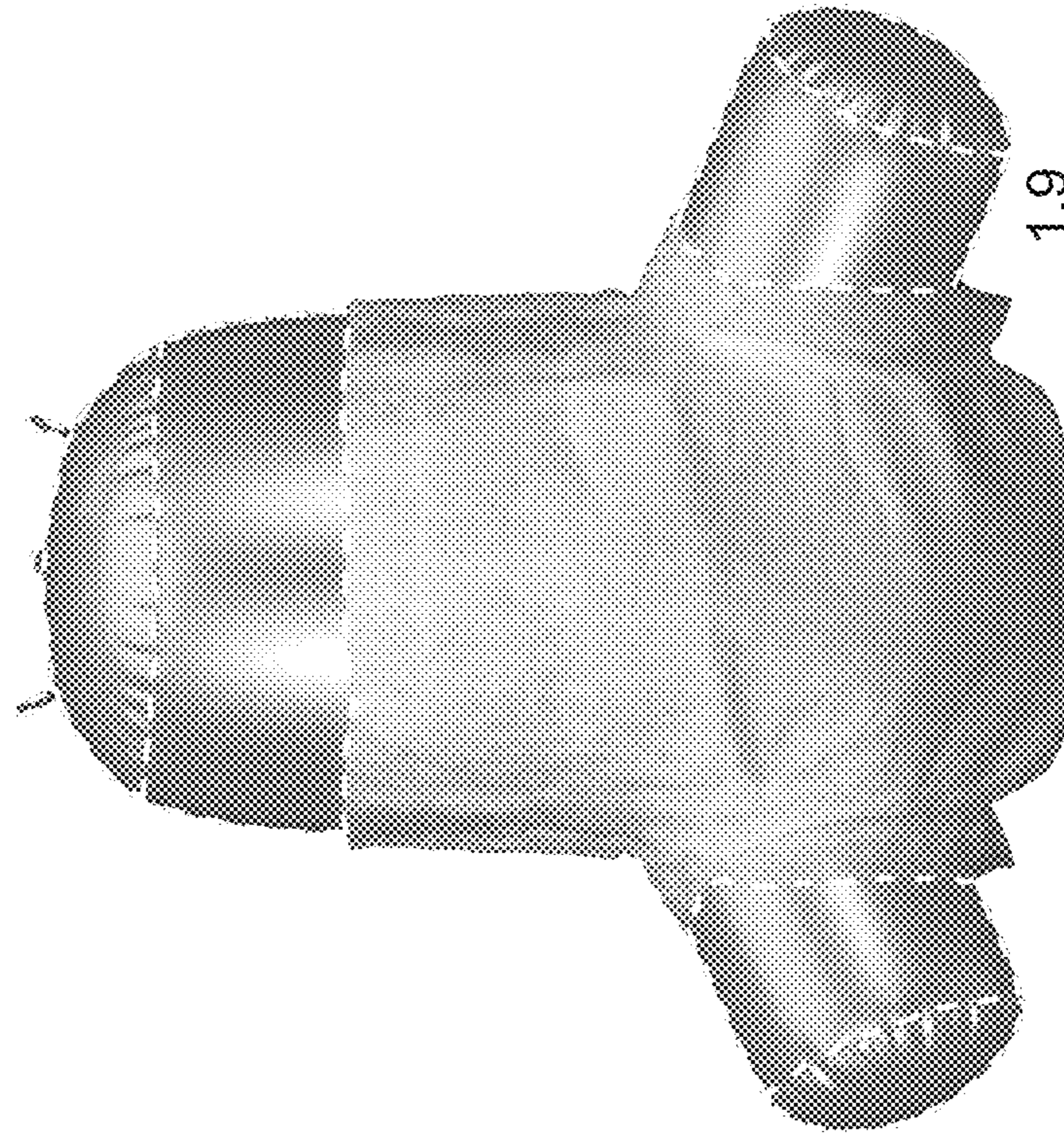

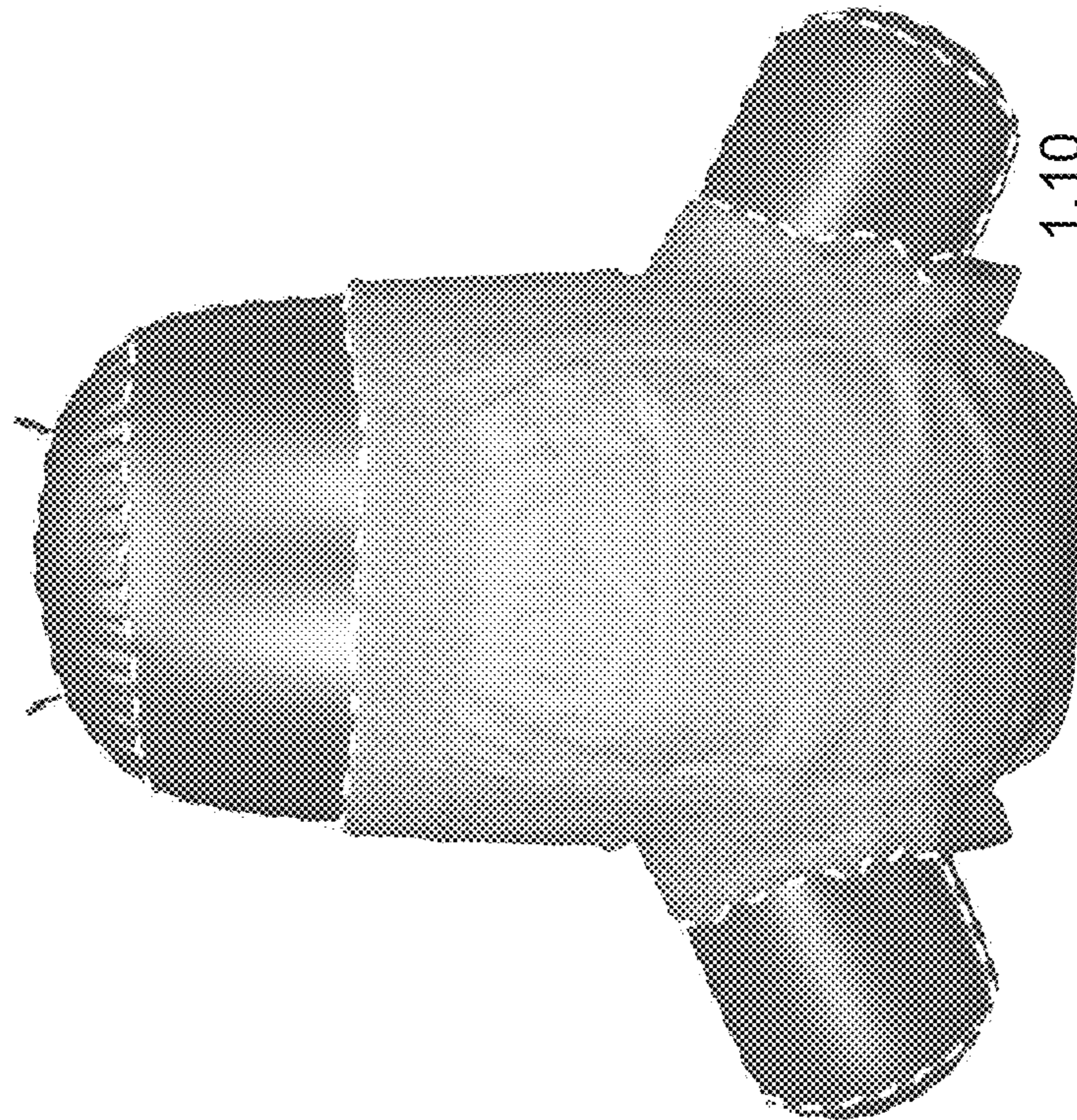

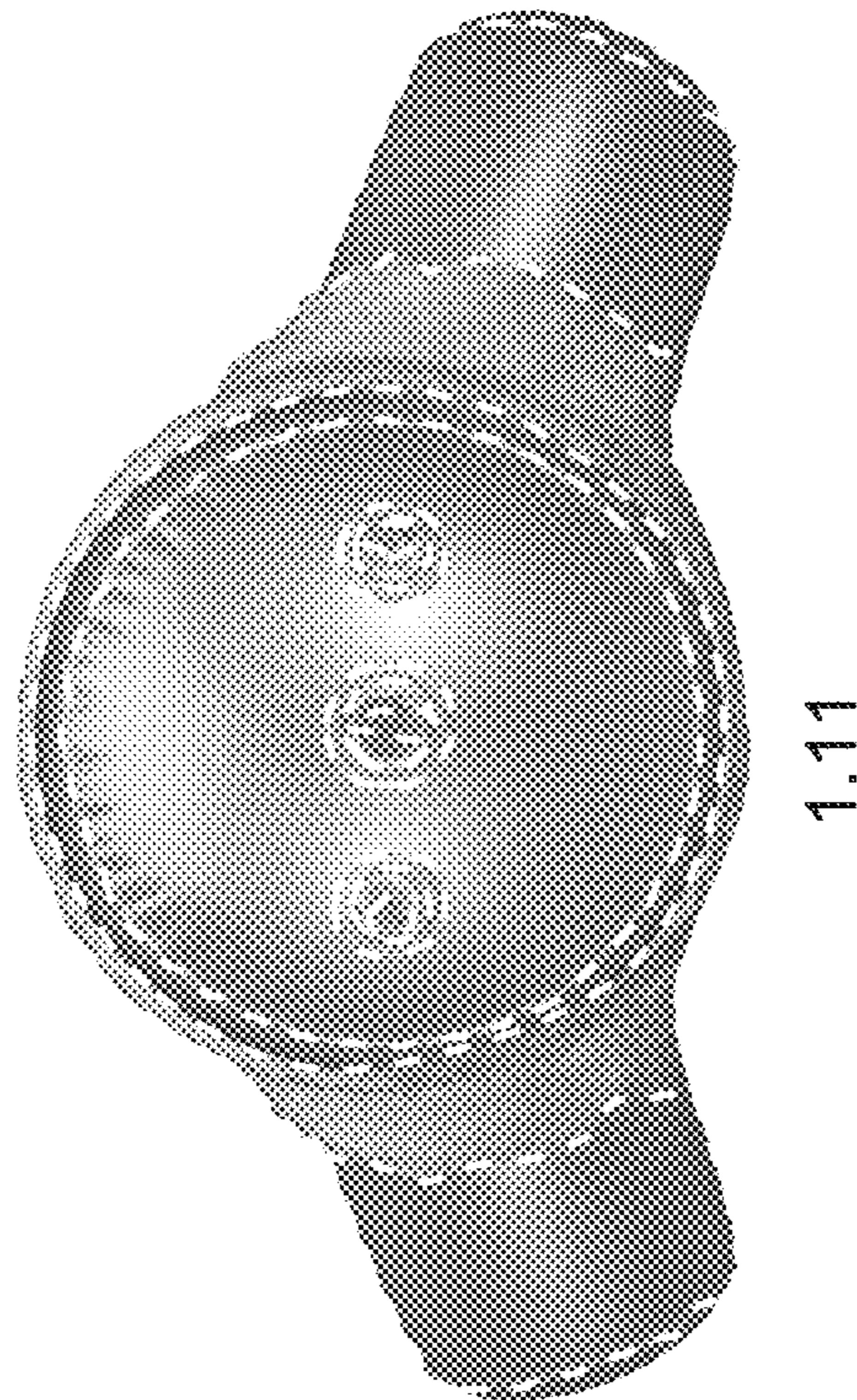

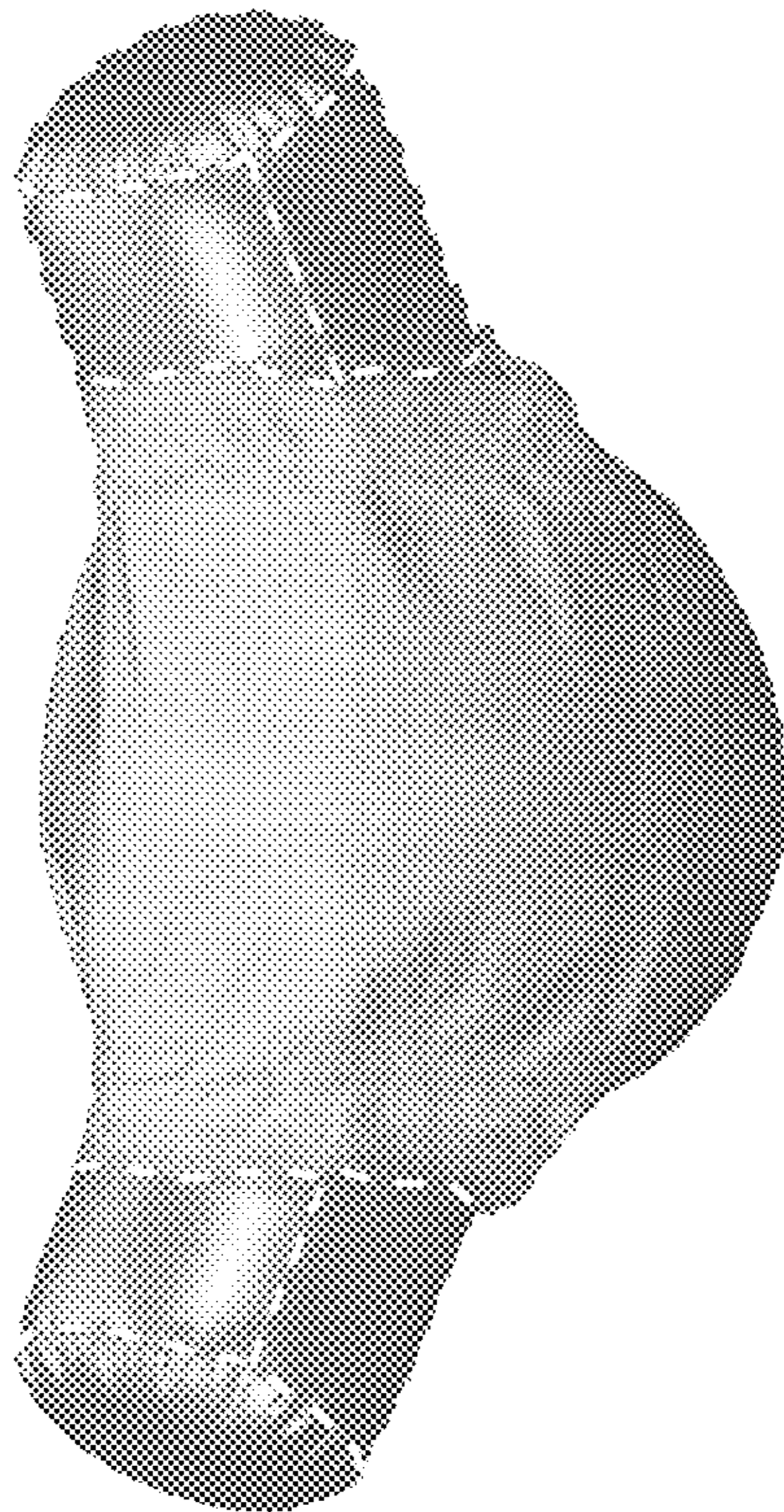

1.12

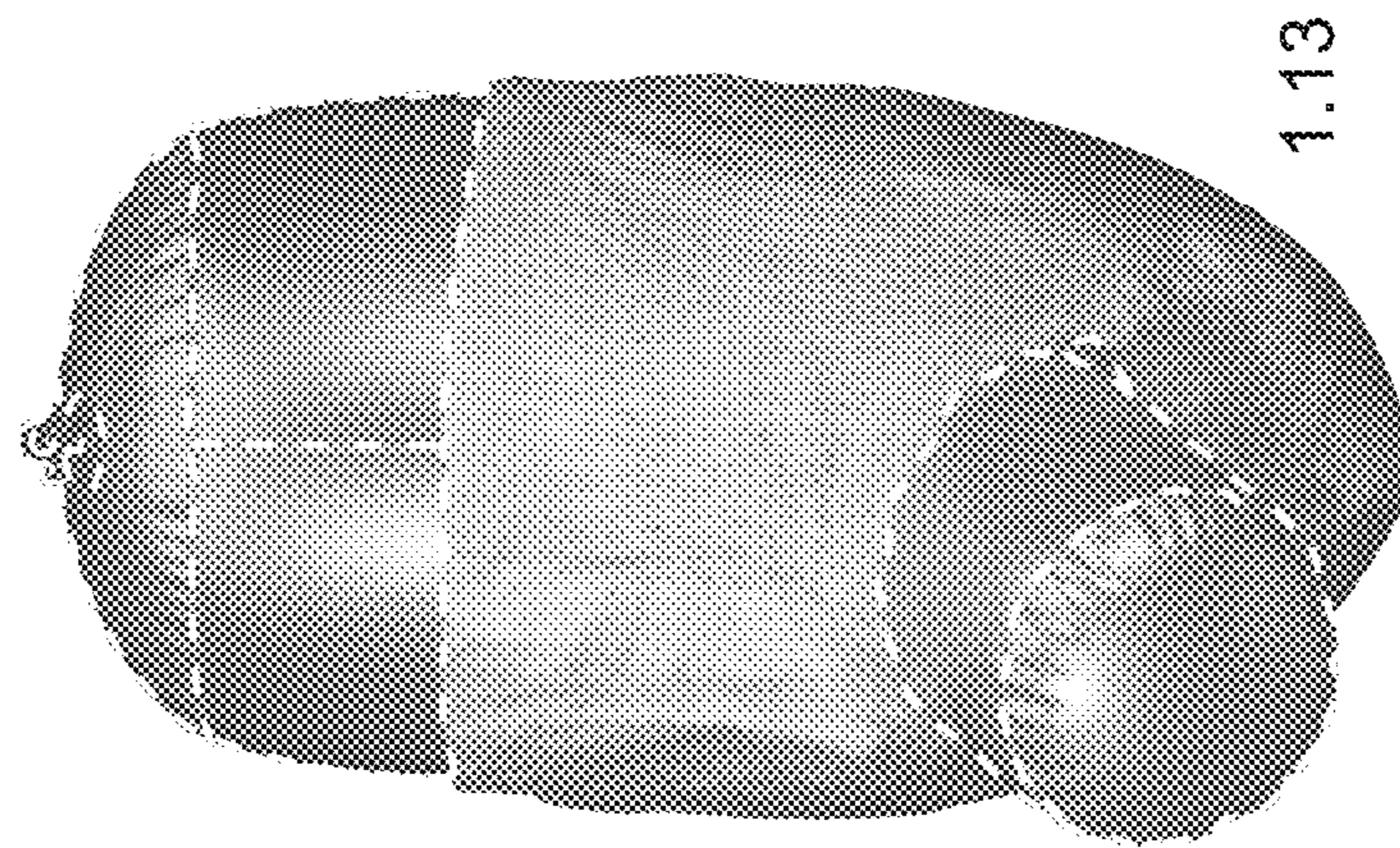

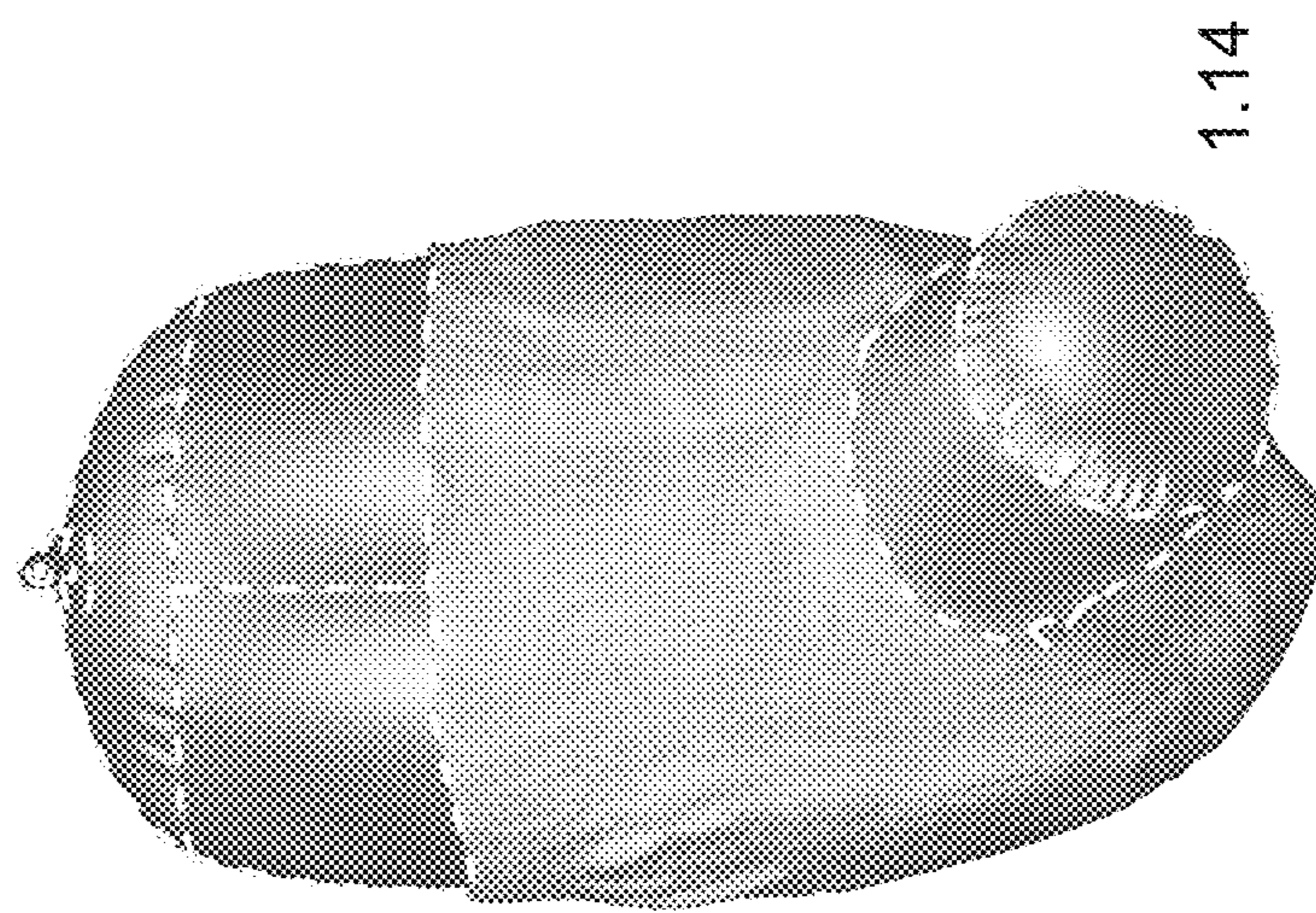

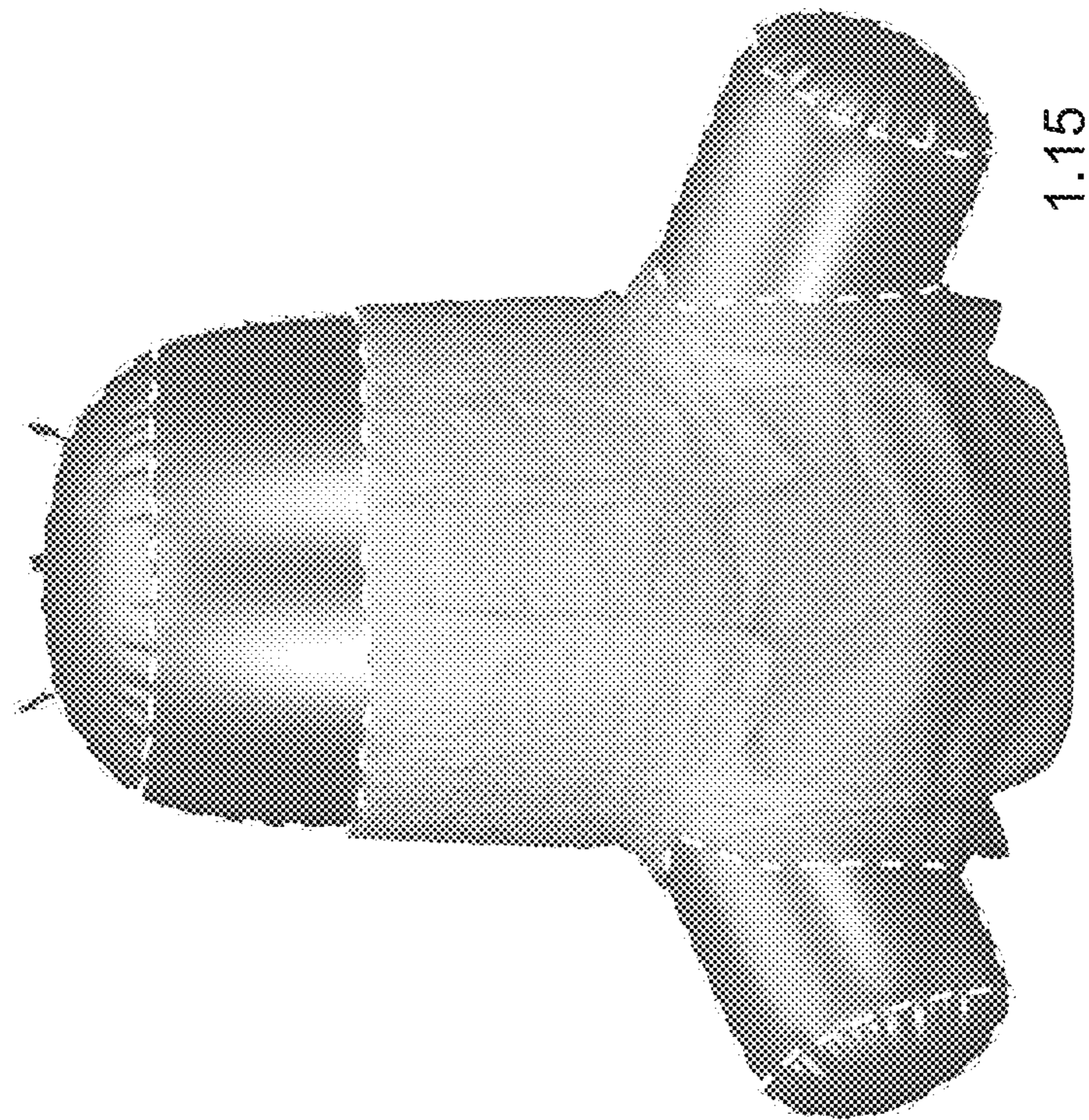

1.15