



US00D984870S

(12) **United States Design Patent**
Lyytikäinen

(10) **Patent No.:** **US D984,870 S**

(45) **Date of Patent:** **** May 2, 2023**

(54) **WATERING REEL**

(71) Applicant: **Fiskars Finland Oy Ab**, Helsinki (FI)

(72) Inventor: **Sami Lyytikäinen**, Helsinki (FI)

(73) Assignee: **FISKARS FINLAND OY AB**, Helsinki (FI)

(**) Term: **15 Years**

(21) Appl. No.: **29/739,753**

(22) Filed: **Jun. 29, 2020**

(30) **Foreign Application Priority Data**

Jan. 10, 2020 (EM) 007497482

(51) **LOC (14) Cl.** **08-11**

(52) **U.S. Cl.**
USPC **D8/358; D8/359**

(58) **Field of Classification Search**
USPC D8/354, 349, 356, 367, 360, 358, 359
CPC ... A01K 89/015; A01K 89/0189; A01K 89/00
See application file for complete search history.

(56) **References Cited**

U.S. PATENT DOCUMENTS

- 1,765,903 A * 6/1930 Case A01K 89/015
242/260
- 1,832,421 A * 11/1931 Pflueger A01K 89/046
242/298
- 2,760,357 A * 8/1956 Burns A01K 89/01907
242/312

- D556,023 S * 11/2007 Reeder D8/358
- D556,548 S * 12/2007 Lin D8/359
- D666,080 S * 8/2012 Boehler D8/359
- D767,374 S * 9/2016 Vanttilä D8/356
- D828,672 S * 9/2018 Lyytikäinen D34/24
- D869,941 S * 12/2019 Exley D8/358
- D871,197 S * 12/2019 Huneau D8/359
- D885,872 S * 6/2020 Miyawaki D8/359
- 10,858,217 B2 * 12/2020 Poutiainen B65H 75/4471
- D938,264 S * 12/2021 Jones D8/359
- D939,943 S * 1/2022 Uccellani D8/358
- D957,916 S * 7/2022 Whitehead D8/359

* cited by examiner

Primary Examiner — Keli L Hill

Assistant Examiner — Harold E Blackwell, II

(74) *Attorney, Agent, or Firm* — Leason Ellis LLP

(57) **CLAIM**

The ornamental design for a watering reel, as shown and described.

DESCRIPTION

FIG. 1 is a rear-left perspective view of my watering reel according to my new design;
 FIG. 2 is a front view thereof;
 FIG. 3 is a rear view thereof;
 FIG. 4 is right-side view thereof;
 FIG. 5 is a left-side view thereof;
 FIG. 6 is a top plan view thereof; and,
 FIG. 7 is a bottom plan view thereof.
 The broken lines depict portions of the watering reel in which the design is embodied that form no part of the claimed design.

1 Claim, 7 Drawing Sheets

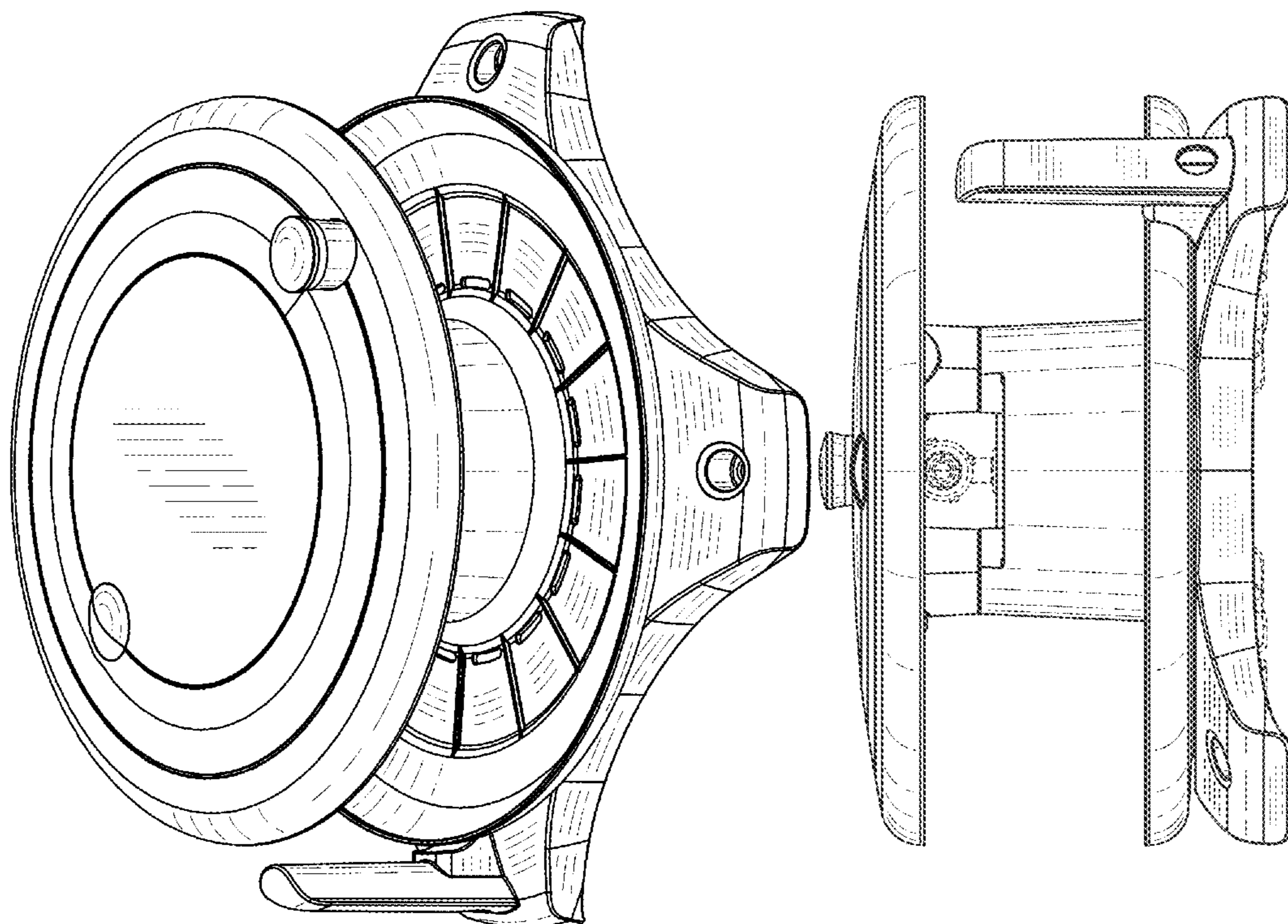

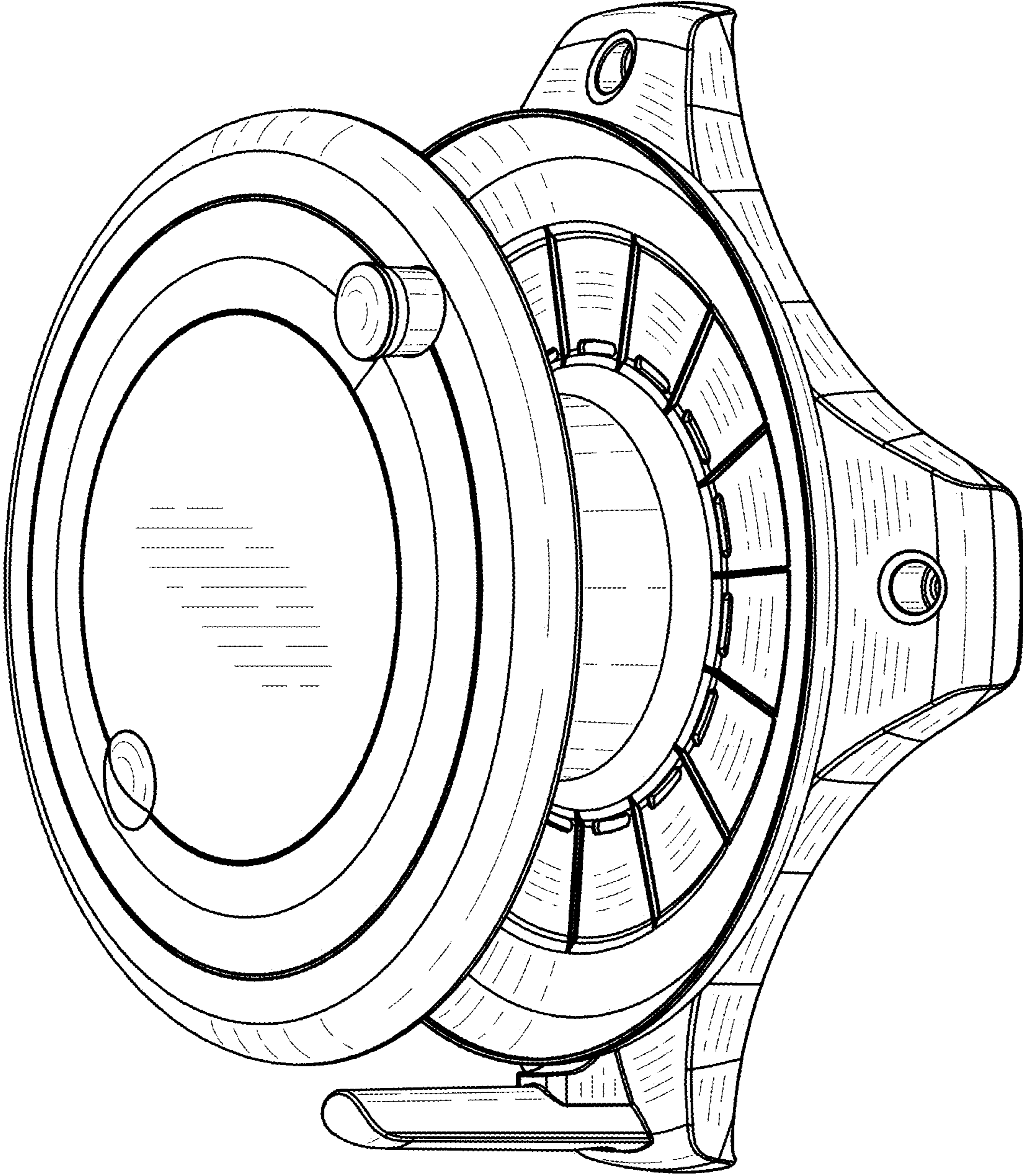

FIG. 1

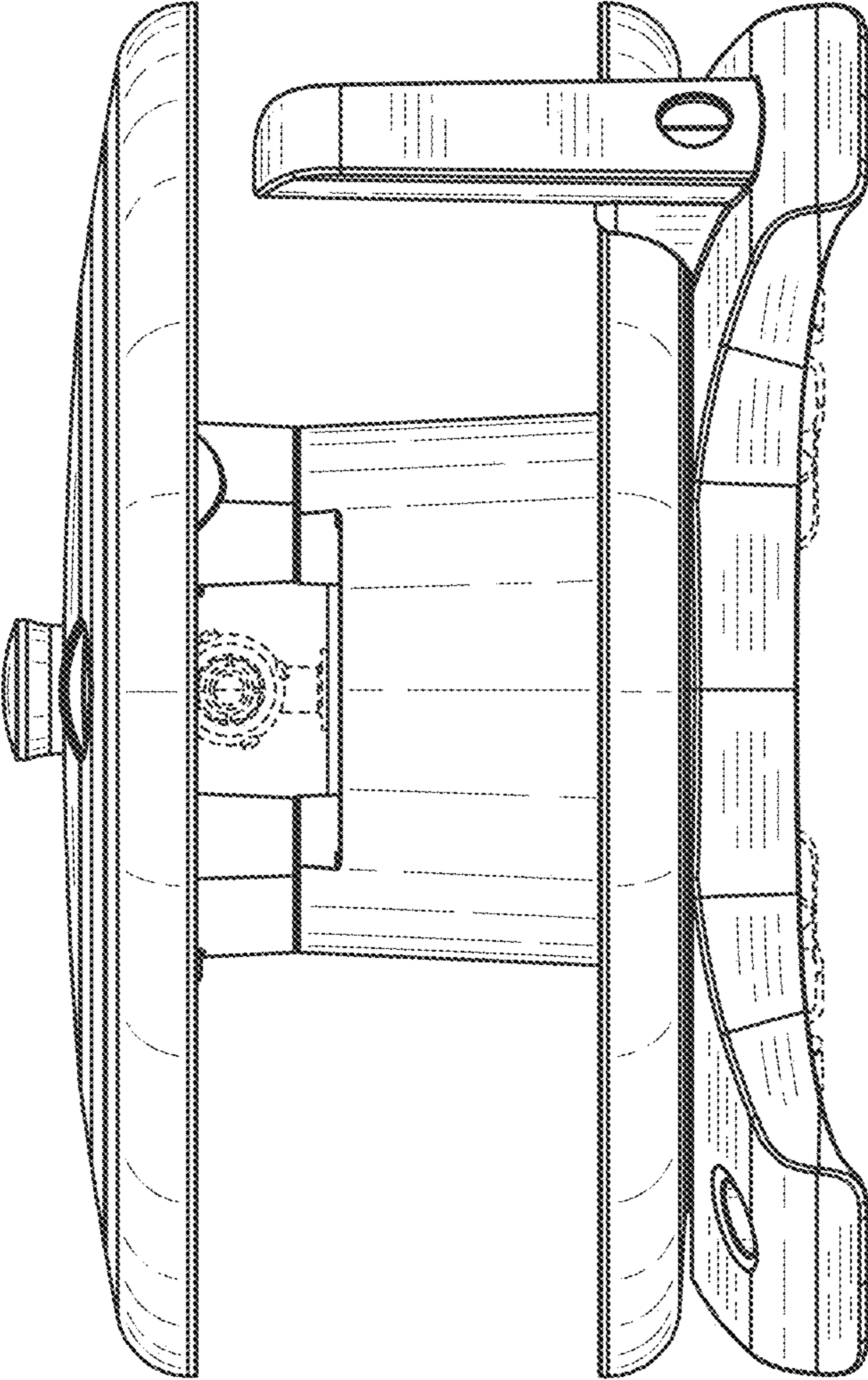

FIG. 2

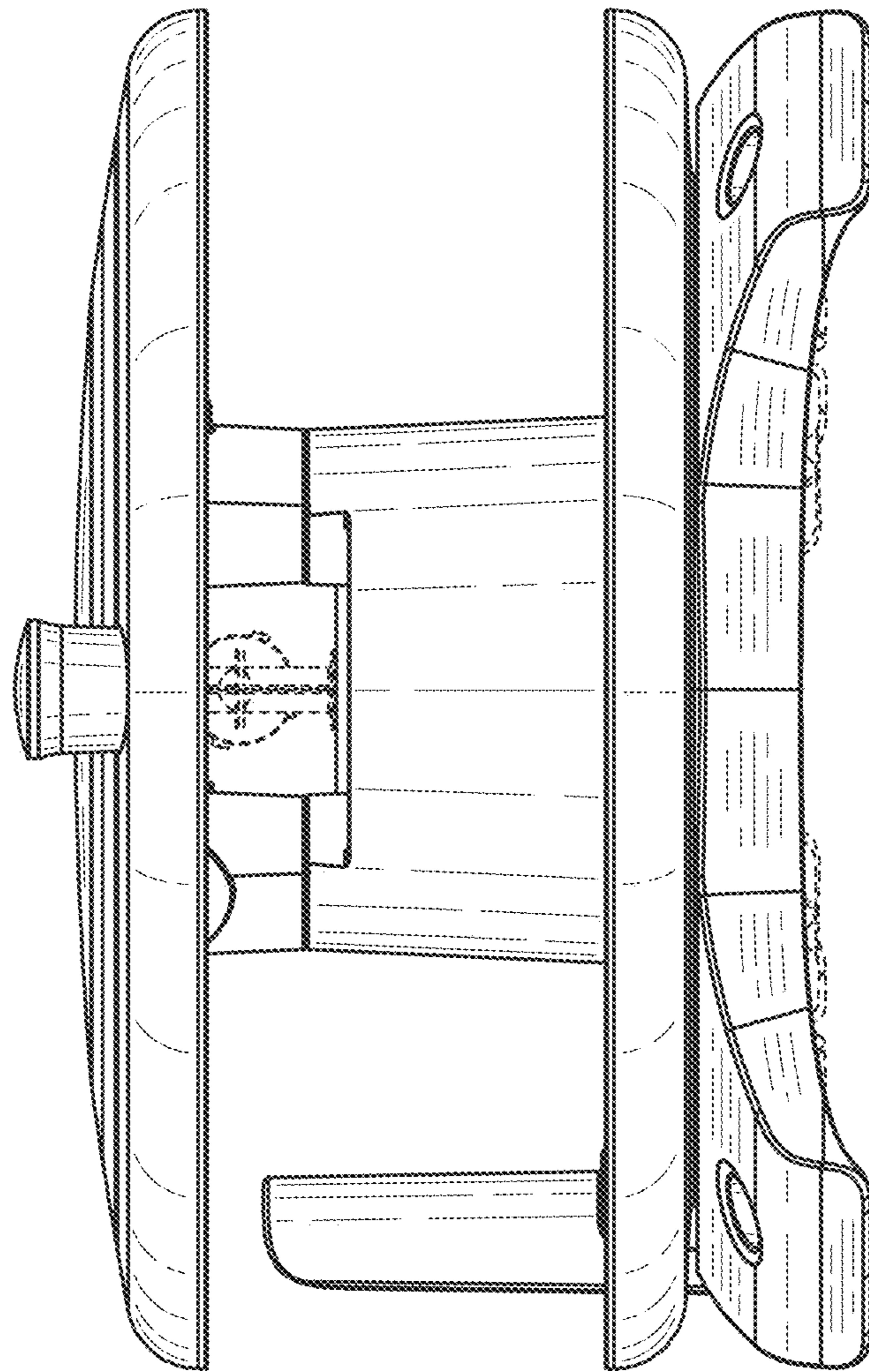

FIG. 3

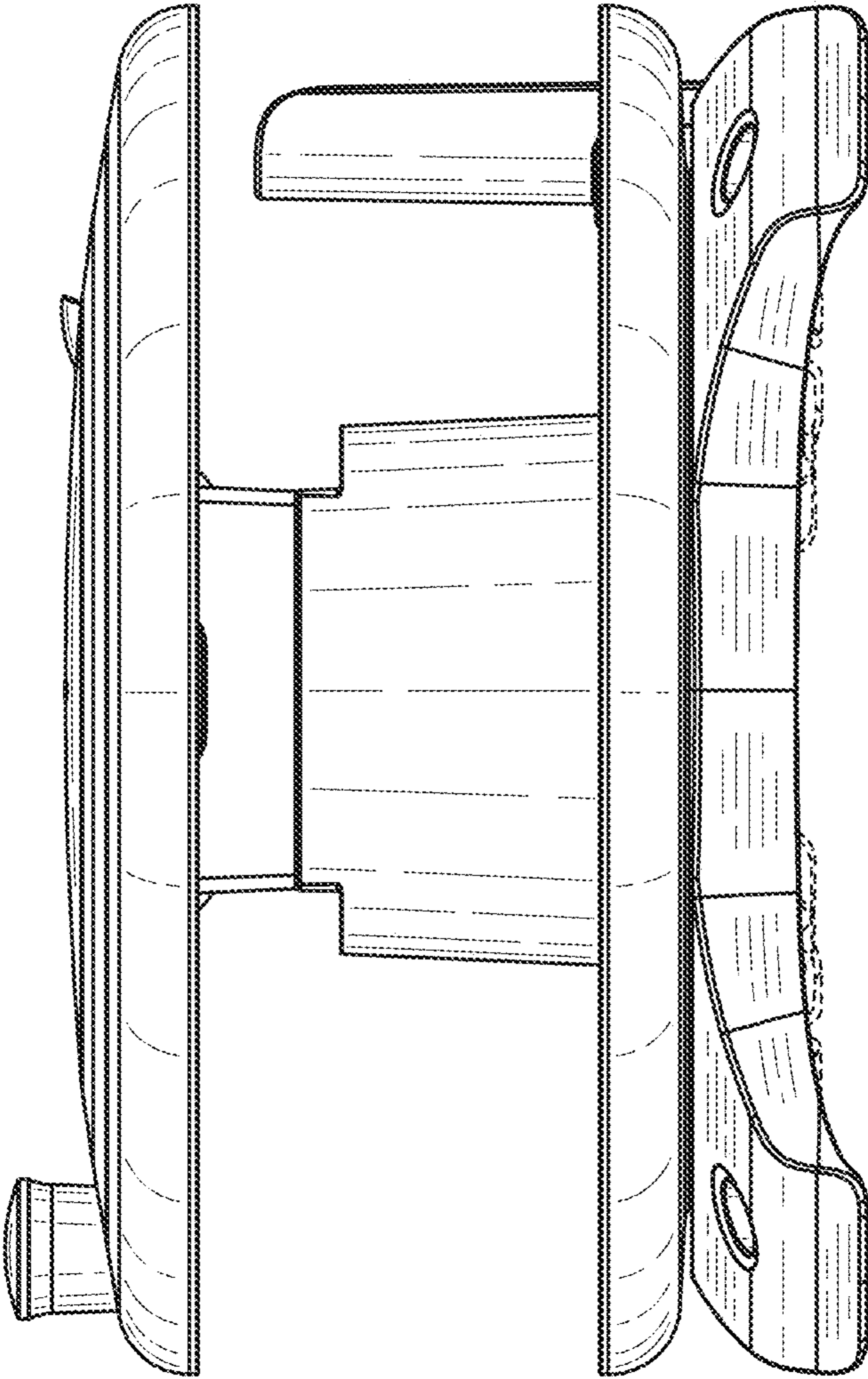

FIG. 4

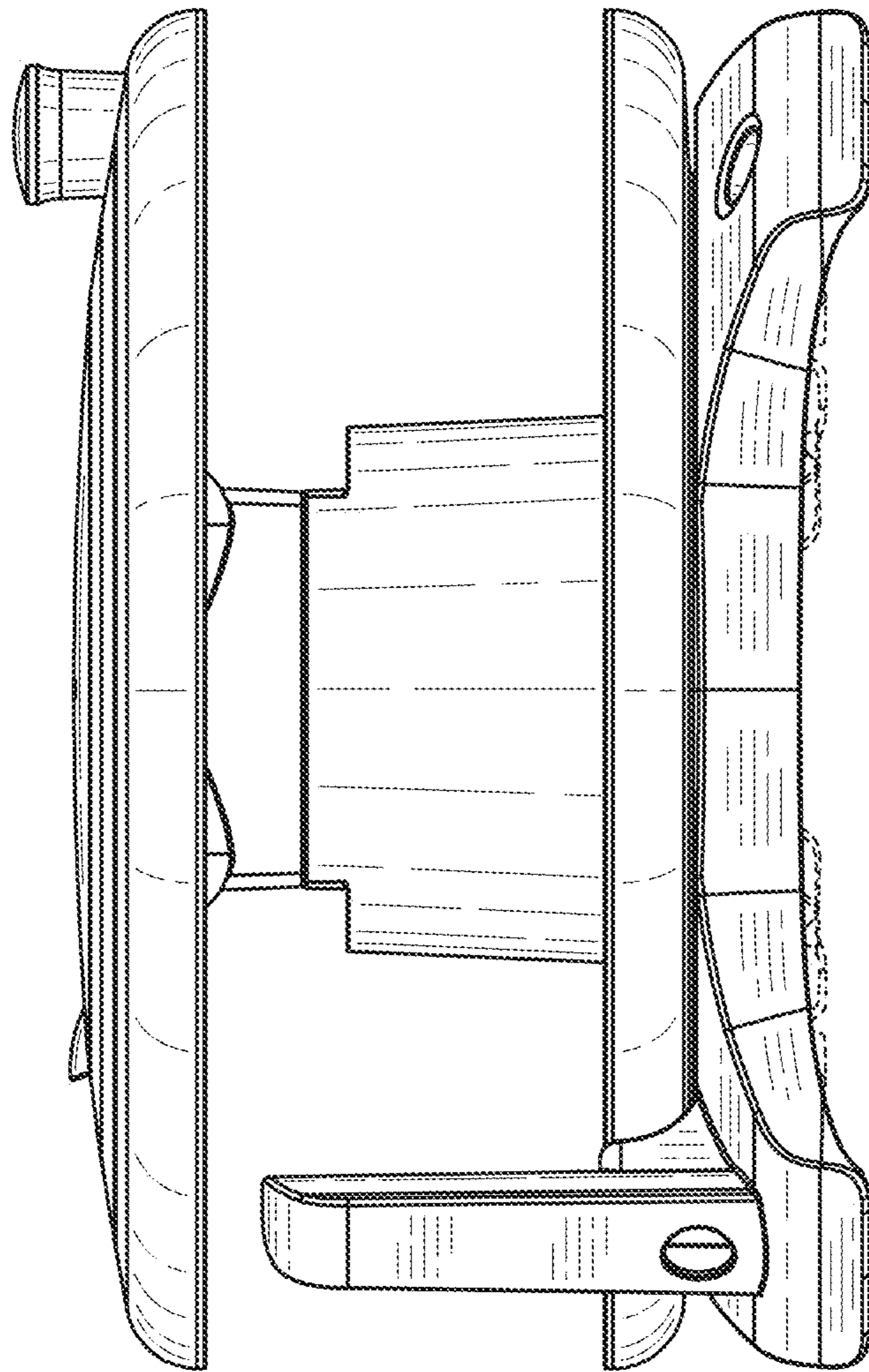

FIG. 5

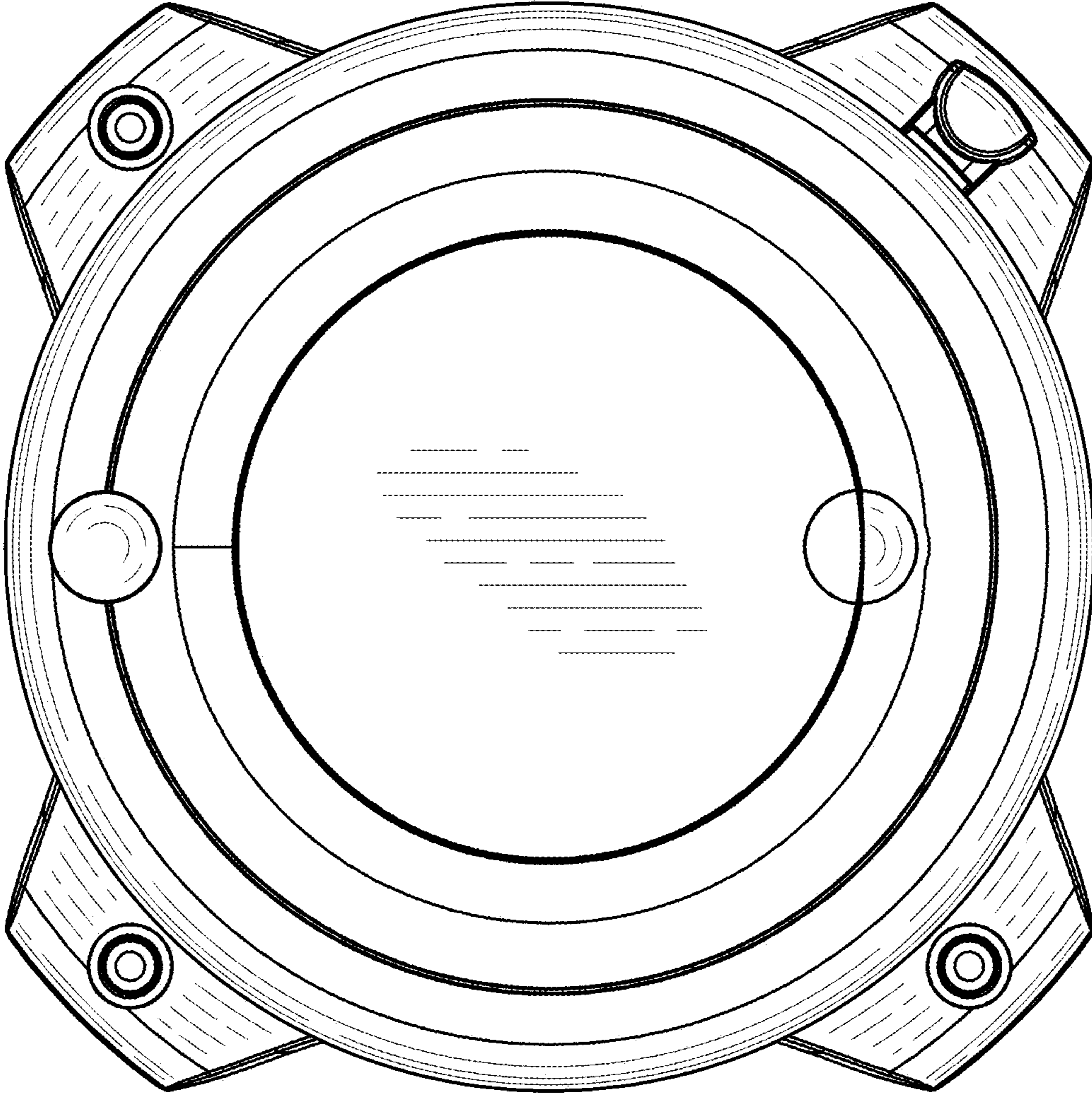

FIG. 6

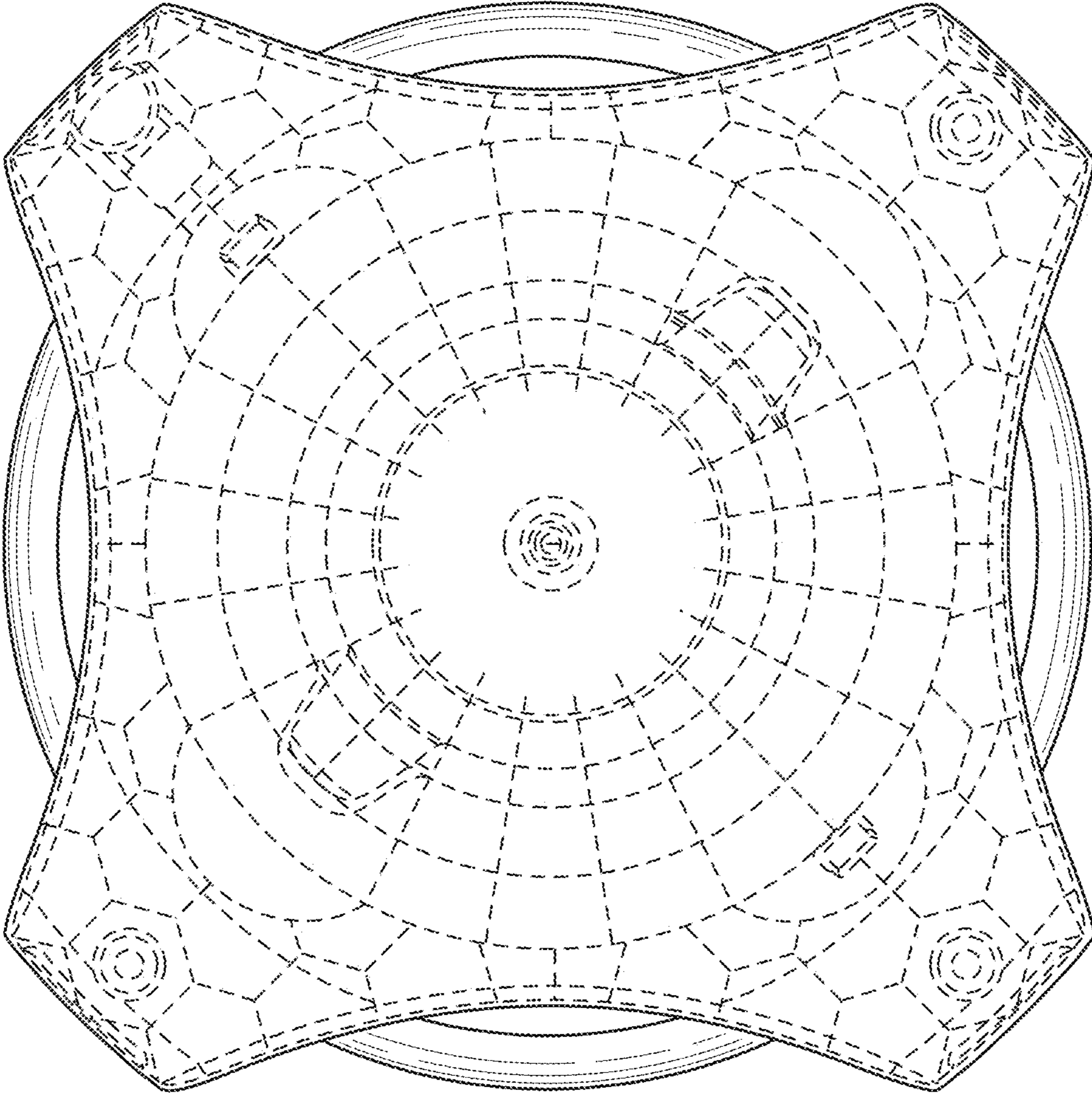

FIG. 7