



US00D984800S

(12) **United States Design Patent** (10) **Patent No.:** **US D984,800 S**  
**Li** (45) **Date of Patent:** **\*\* May 2, 2023**

(54) **BOOK BAG**  
(71) Applicant: **Shaochong Li**, Foshan (CN)  
(72) Inventor: **Shaochong Li**, Foshan (CN)  
(\*\*) Term: **15 Years**  
(21) Appl. No.: **29/860,587**  
(22) Filed: **Nov. 21, 2022**  
(51) **LOC (14) Cl.** ..... **03-01**  
(52) **U.S. Cl.**  
USPC ..... **D3/217**  
(58) **Field of Classification Search**  
USPC ..... D3/201, 203.1, 203.2, 203.3, 203.6,  
D3/203.7, 203.8, 207-211, 215-218,  
D3/224-228, 230-233, 242-251, 273,  
D3/274, 288-290, 310-315, 318-323;  
D7/709; D9/715-721, 737-741, 747,  
D9/414, 421, 435, 444, 455, 499,  
D9/431-433; D11/78.1  
CPC ..... A47G 21/14; A47J 47/16; A47J 47/00;  
B65D 1/00; B65D 1/22; B65D 1/24;  
B65D 1/36; B65D 5/46072; B65D  
25/2841; B65D 81/3813; B65D 81/3823;  
B65D 88/00; B65D 88/02; B65D 88/025;  
B65D 88/123; B65D 88/128; B65D  
88/1656; A45F 5/02; A45F 2200/05; A61J  
1/03; A61J 7/0084  
See application file for complete search history.

(56) **References Cited**  
U.S. PATENT DOCUMENTS  
D446,008 S \* 8/2001 Schulze ..... D3/217  
6,510,974 B2 \* 1/2003 Willingham ..... A45C 7/0095  
D3/217

D552,350 S 10/2007 Bosley  
D604,503 S \* 11/2009 Patadia ..... D3/217  
D635,761 S \* 4/2011 Hedaya ..... D3/217  
D646,054 S 10/2011 Littleton  
D661,481 S \* 6/2012 Hedaya ..... D3/217  
D803,550 S \* 11/2017 Shaholli ..... D3/216  
D803,551 S \* 11/2017 Shaholli ..... D3/216  
D804,167 S \* 12/2017 Shaholli ..... D3/216  
D809,784 S \* 2/2018 Lee ..... D3/217  
D809,785 S \* 2/2018 Lee ..... D3/217  
D880,848 S \* 4/2020 Hu ..... D3/217  
D919,961 S \* 5/2021 Sprintz ..... D3/217  
D972,790 S \* 12/2022 Tang ..... D30/145  
2002/0166881 A1 \* 11/2002 Willingham ..... A45C 7/0095  
224/582

\* cited by examiner

*Primary Examiner* — Michelle E. Wilson  
*Assistant Examiner* — Christopher John Suarez La Rosa  
(74) *Attorney, Agent, or Firm* — Jeenam Park

(57) **CLAIM**

The ornamental design for a book bag, as shown and described.

**DESCRIPTION**

FIG. 1 is a front, right and top perspective view of a book bag, showing my new design;  
FIG. 2 is a front, left and bottom perspective view thereof;  
FIG. 3 is a front view thereof;  
FIG. 4 is a rear view thereof;  
FIG. 5 is a left side view thereof;  
FIG. 6 is a right side view thereof;  
FIG. 7 is a top plan view thereof; and,  
FIG. 8 is a bottom plan view thereof.

**1 Claim, 8 Drawing Sheets**

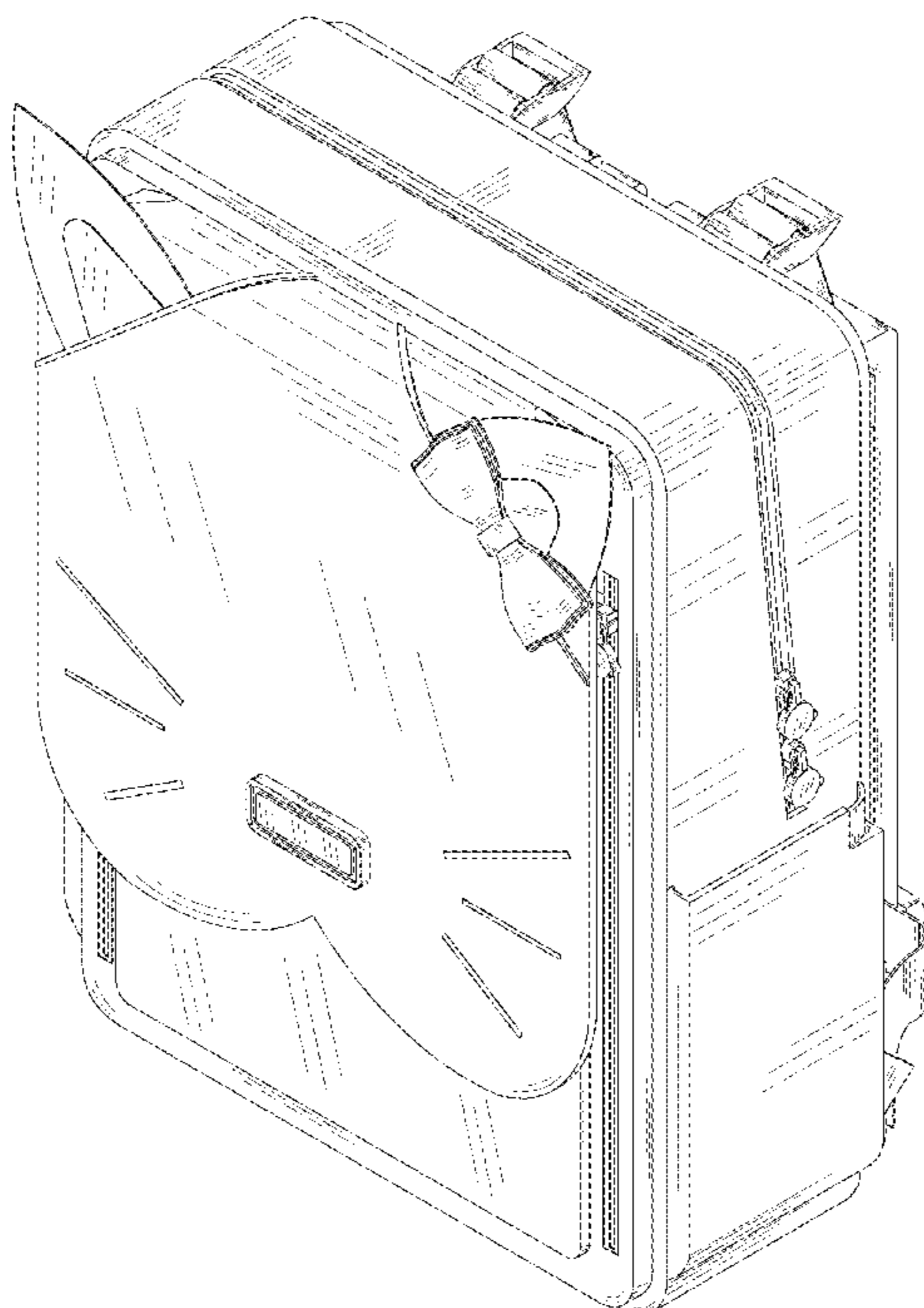

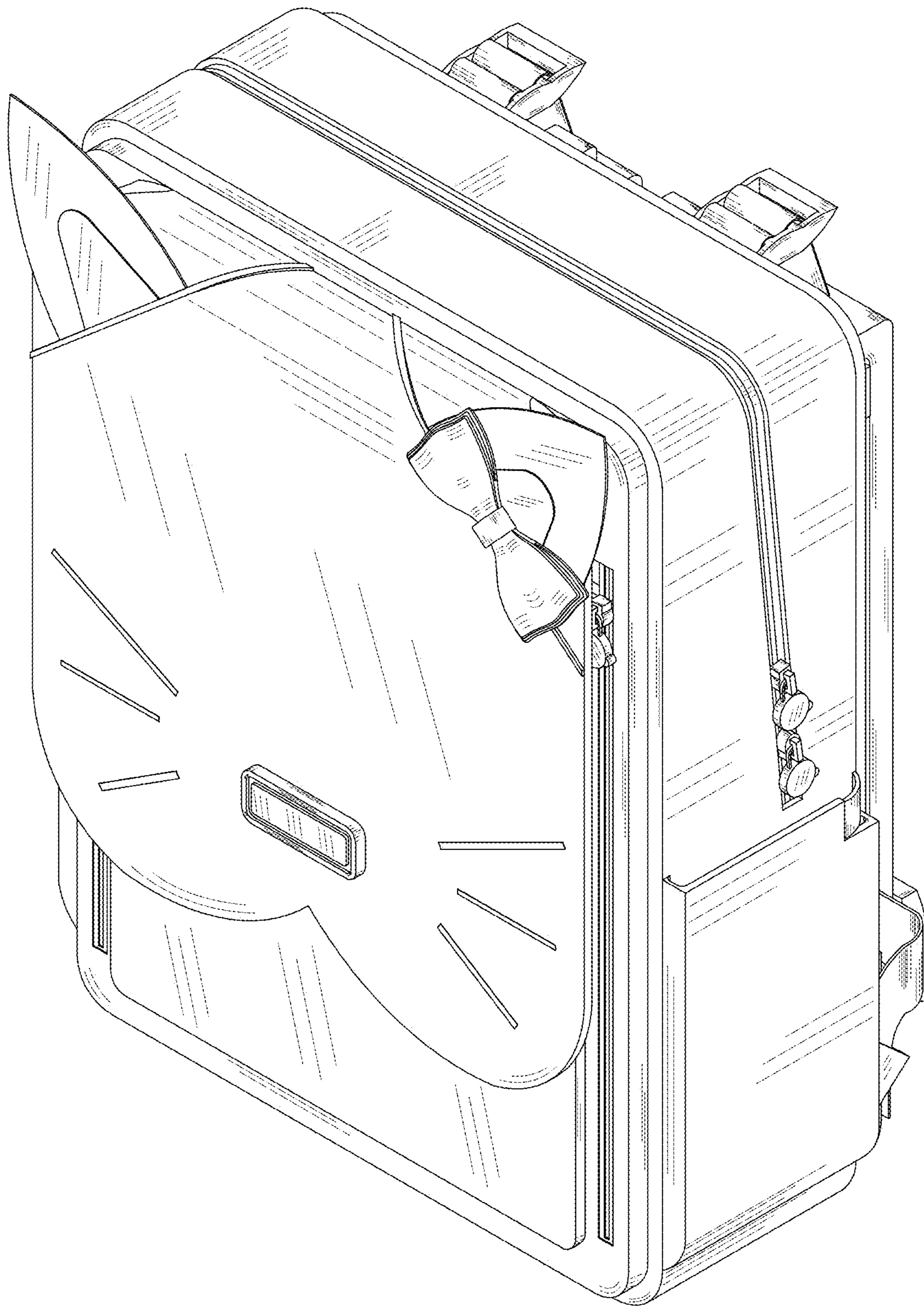

FIG. 1



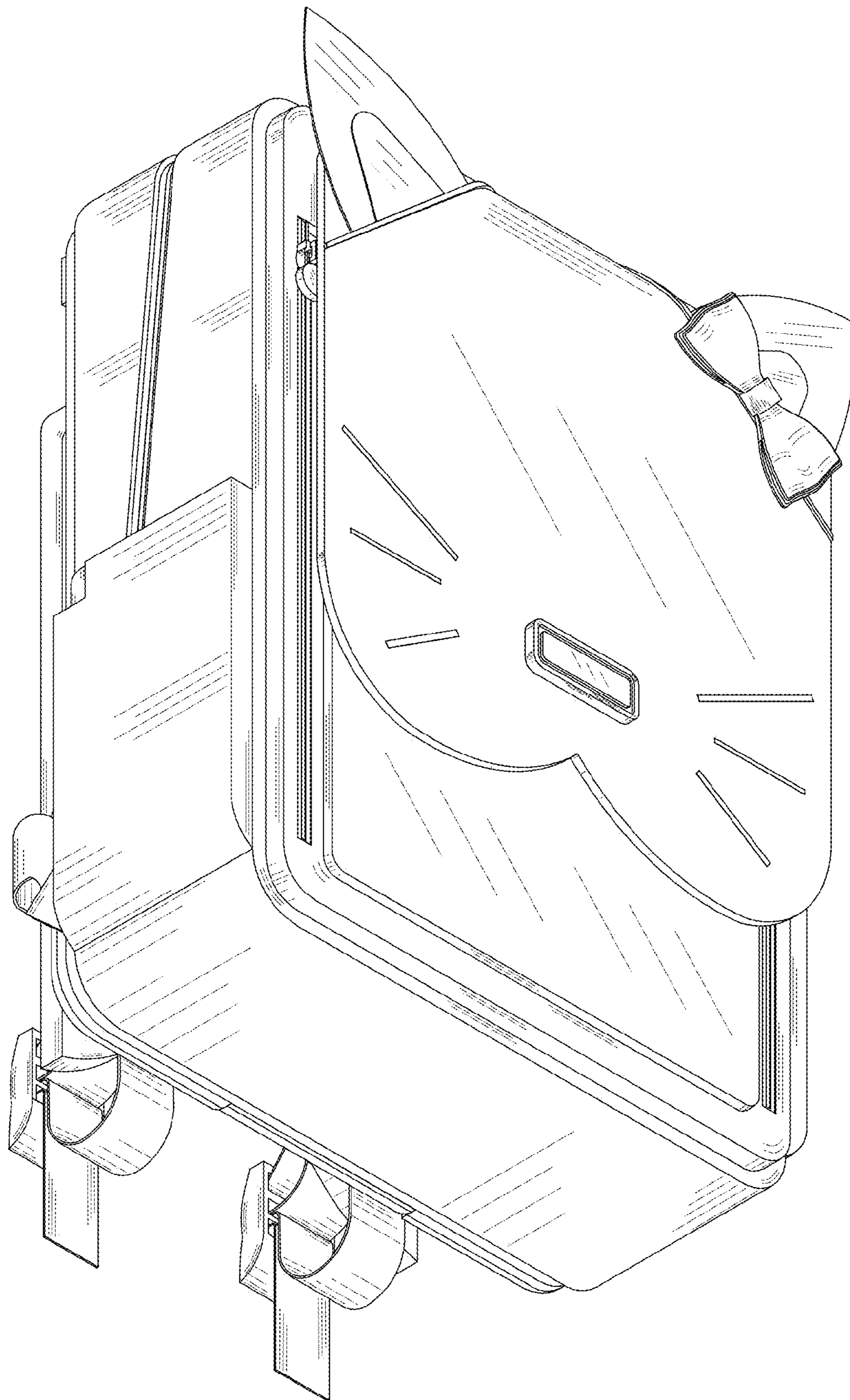

FIG. 2

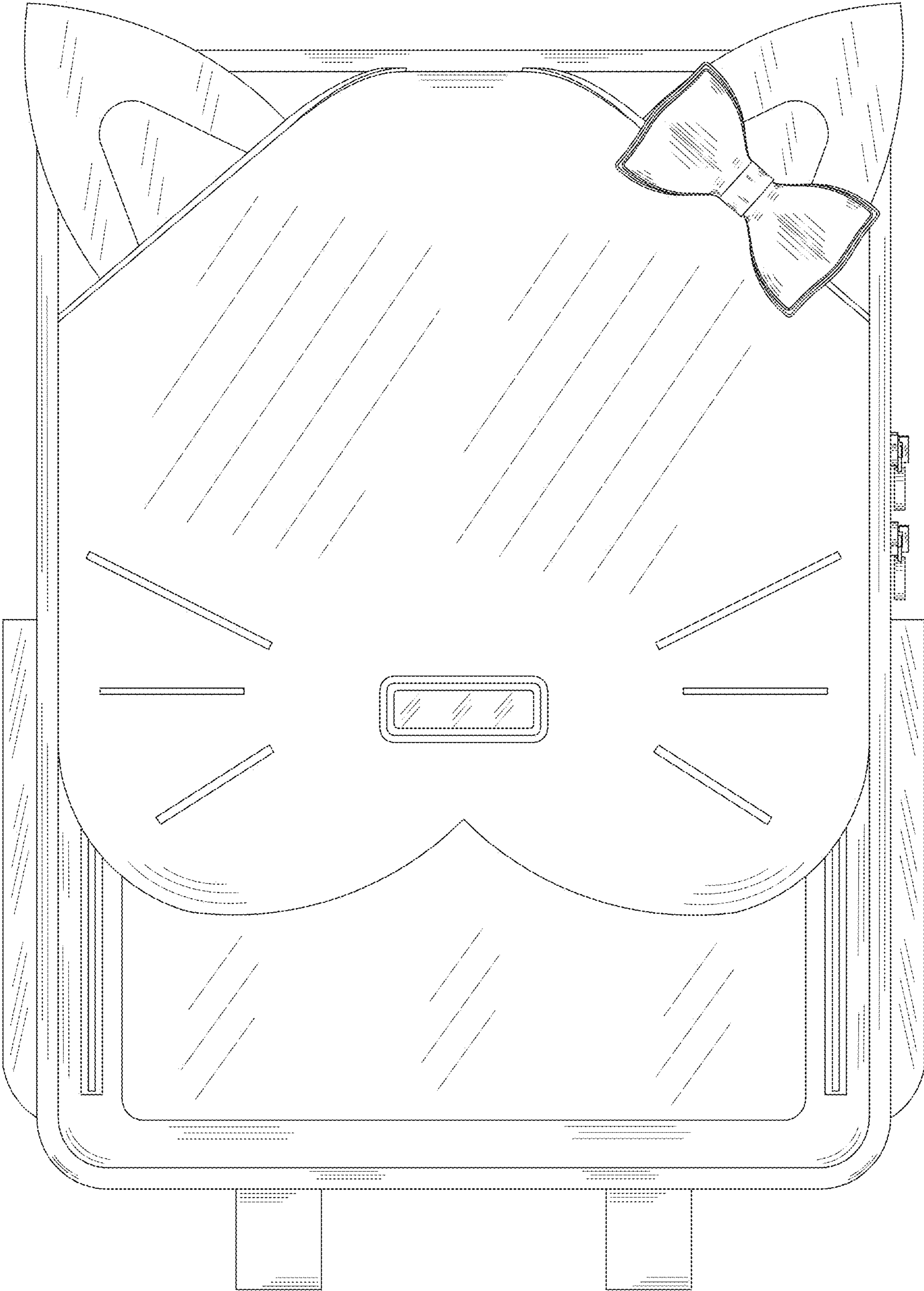

FIG. 3

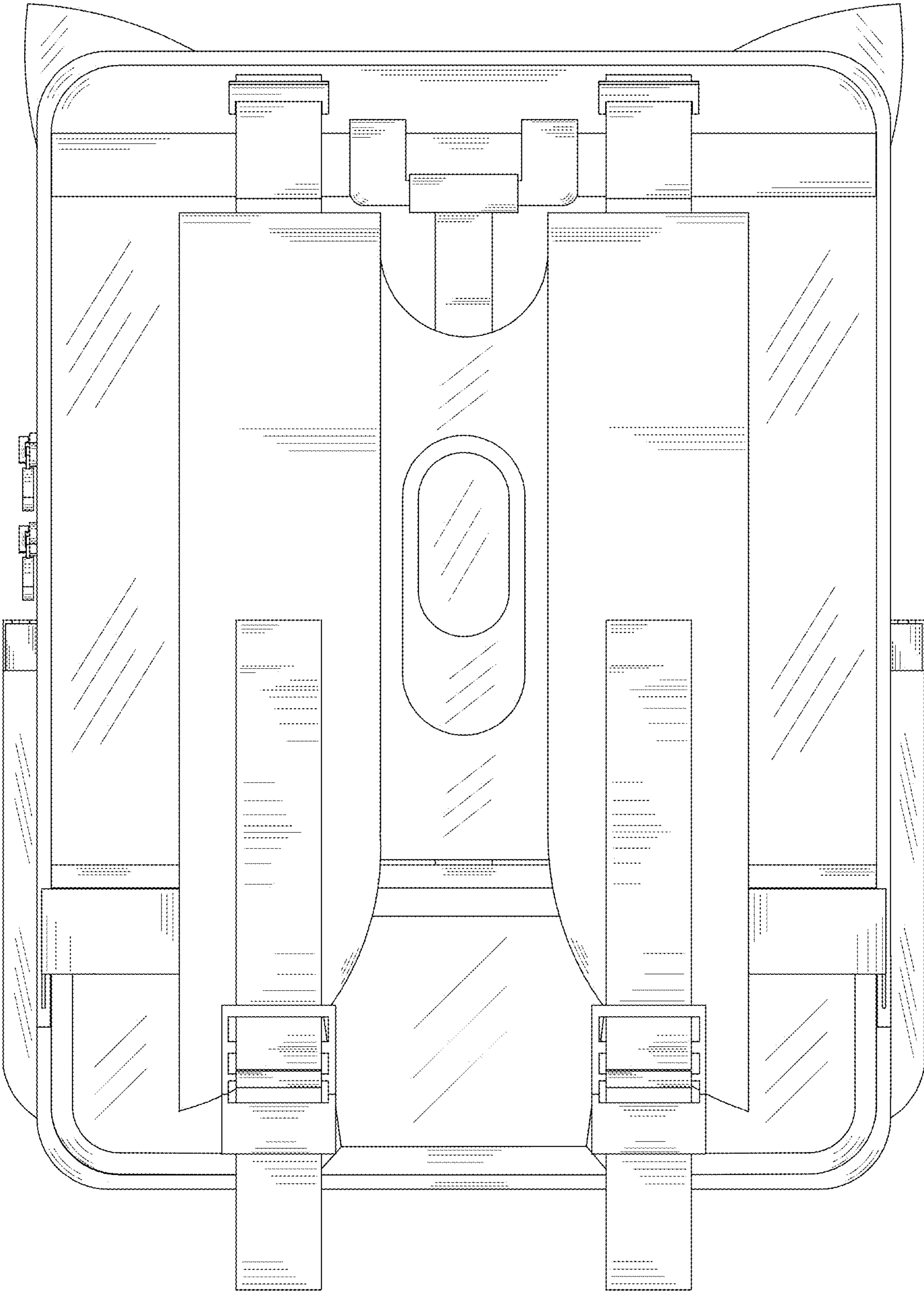

FIG. 4



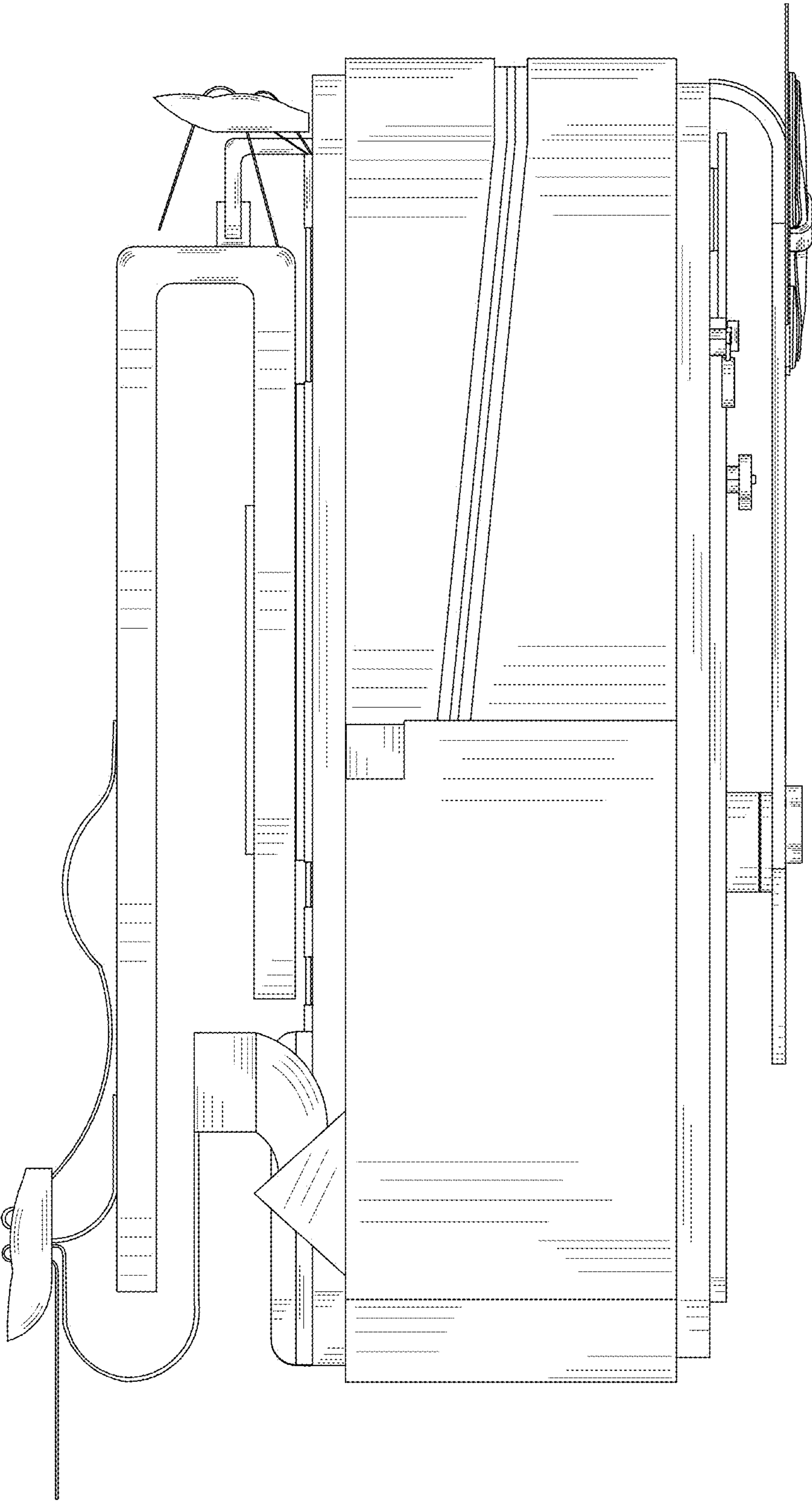

FIG. 5

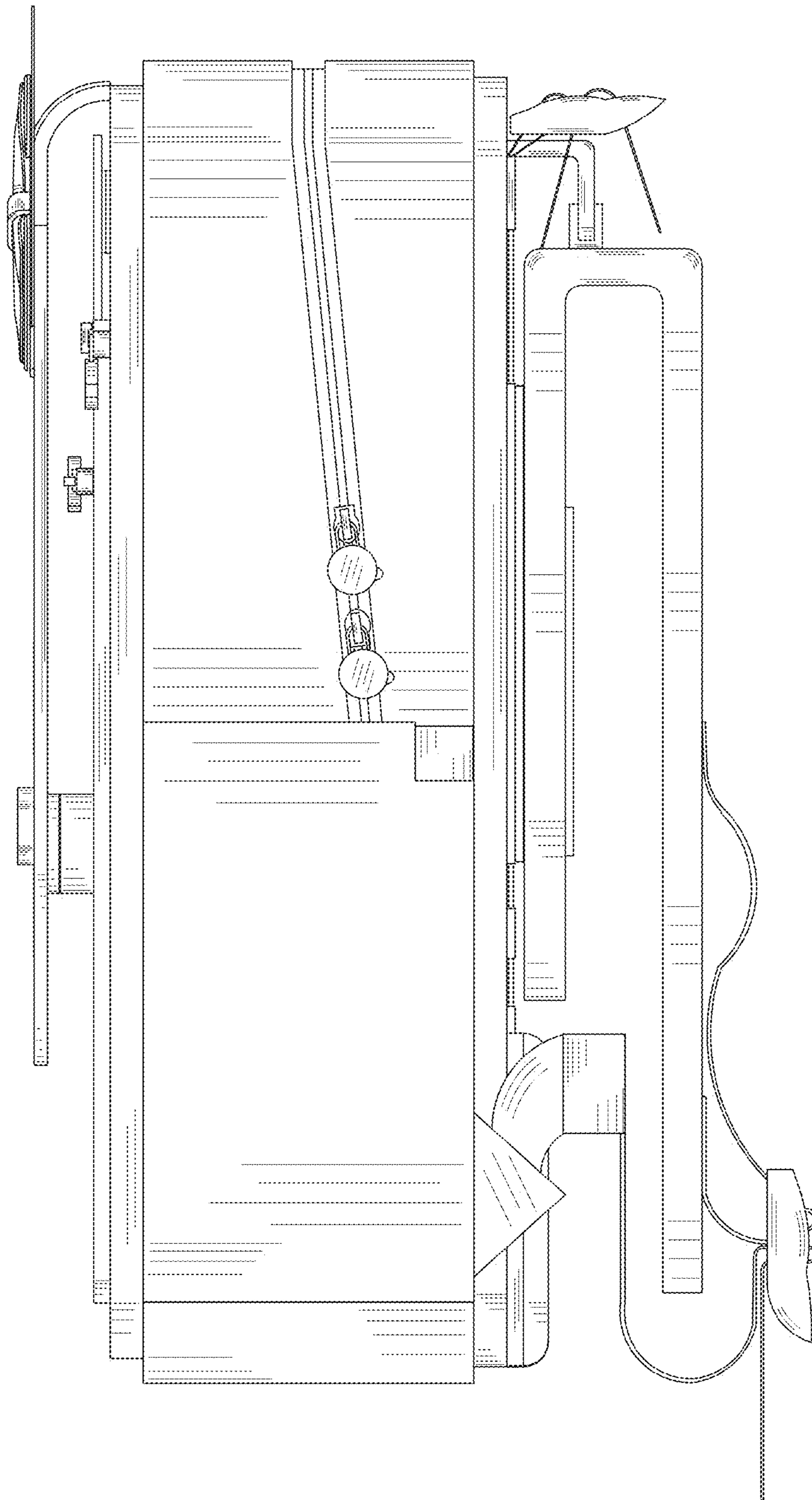

FIG. 6

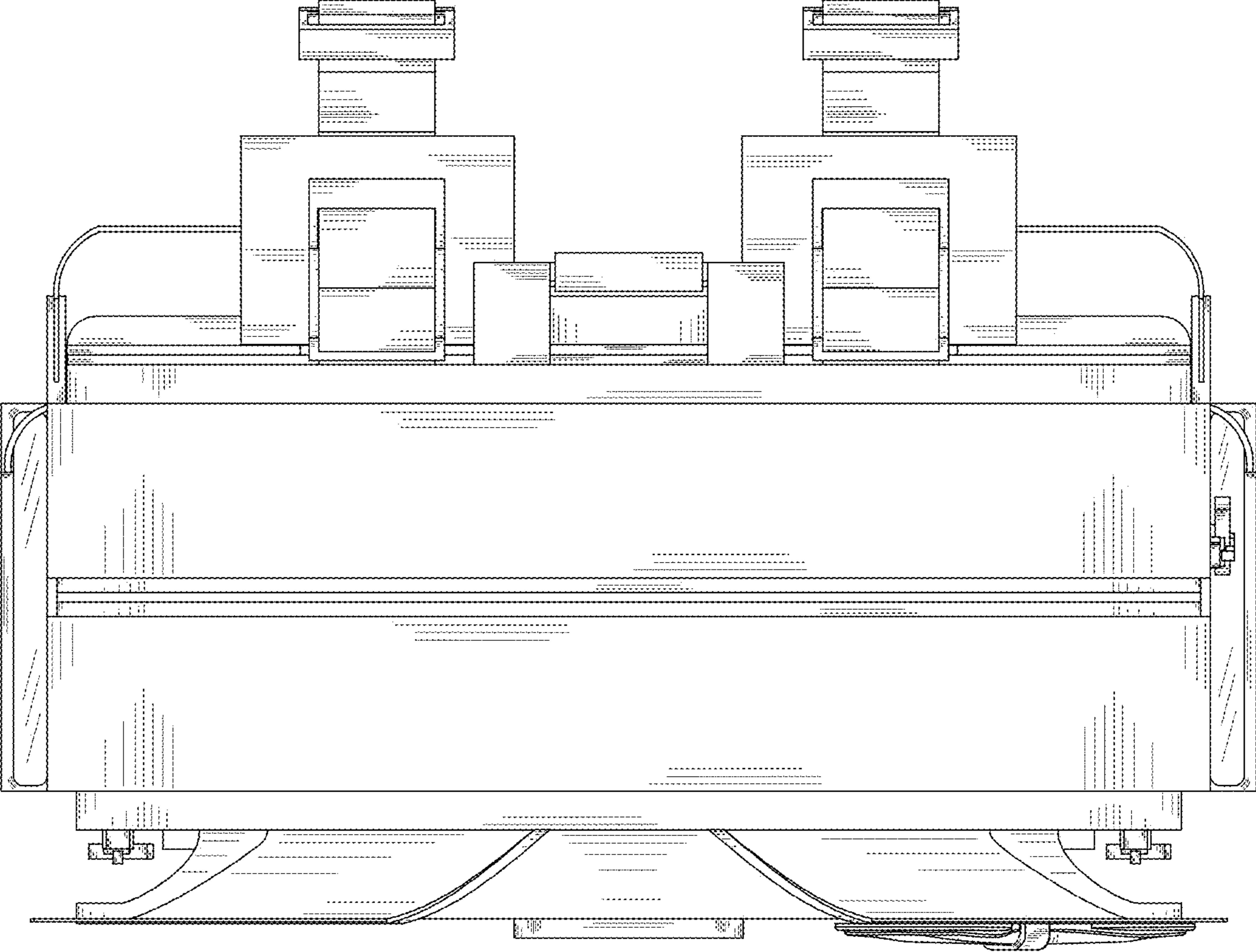

FIG. 7



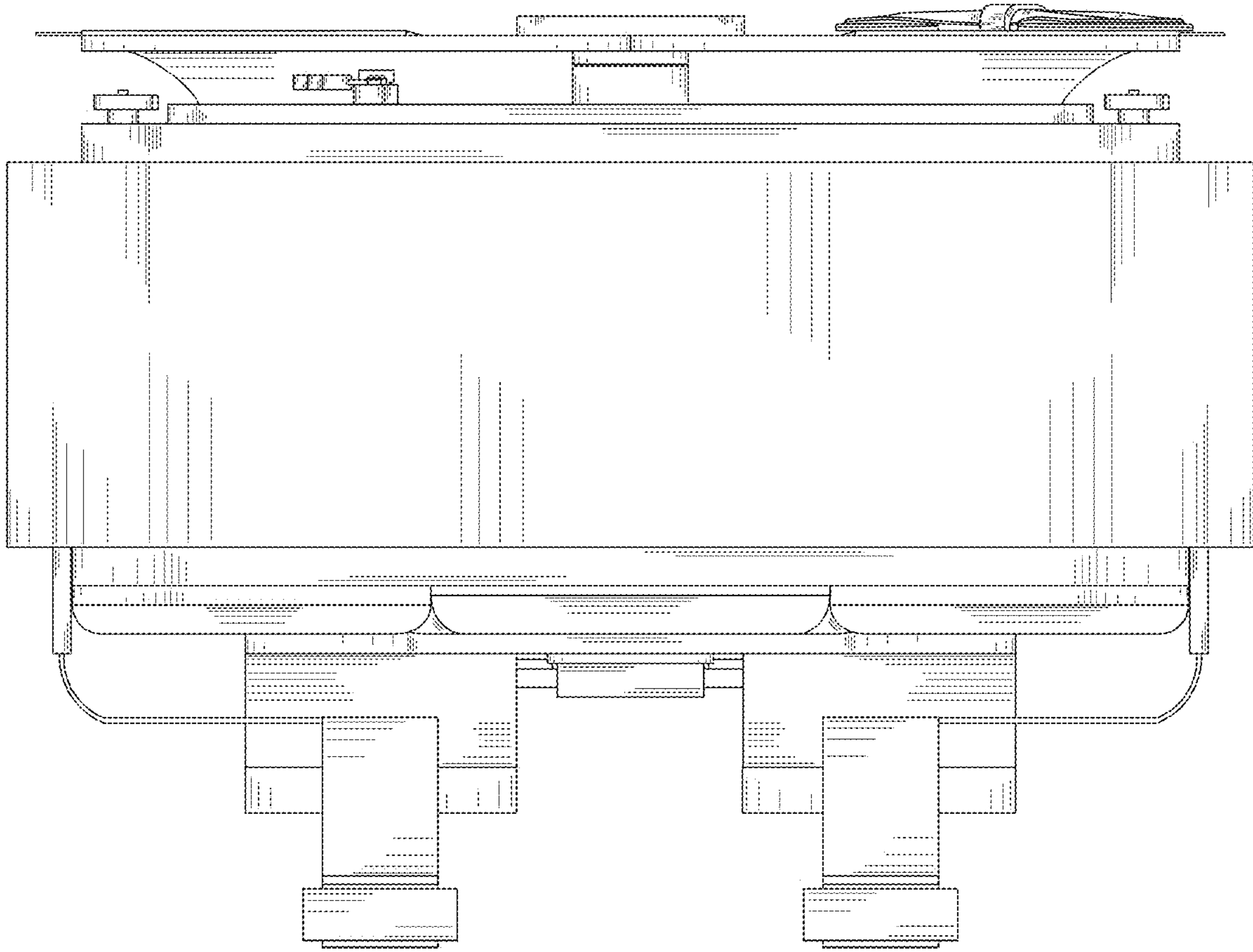

FIG. 8