



US00D984797S

(12) **United States Design Patent**
Fan

(10) **Patent No.:** **US D984,797 S**

(45) **Date of Patent:** **** May 2, 2023**

(54) **INFANT CARRIER**

(71) Applicant: **Wonderland Switzerland AG,**
Steinhausen (CH)

(72) Inventor: **Meifeng Fan,** Dongguan (CN)

(73) Assignee: **Wonderland Switzerland AG,**
Steinhausen (CH)

(**) Term: **15 Years**

(21) Appl. No.: **29/779,022**

(22) Filed: **Apr. 15, 2021**

(30) **Foreign Application Priority Data**

Oct. 16, 2020 (CN) 202030616487.2

(51) **LOC (14) Cl.** **03-05**

(52) **U.S. Cl.**
USPC **D3/214; D3/213**

(58) **Field of Classification Search**
USPC D3/213, 214, 215, 216; D7/719; D6/333
CPC A47D 13/025; A47D 13/02; A61G 1/00
See application file for complete search history.

(56) **References Cited**

U.S. PATENT DOCUMENTS

- 8,172,116 B1 * 5/2012 Lehan A47D 13/025
224/159
- D693,569 S * 11/2013 Lehan D3/214
- D755,508 S * 5/2016 Chuah D3/213
- 9,713,391 B2 * 7/2017 Telford A47D 13/025
- 10,264,895 B2 * 4/2019 Lindeman A47D 13/025
- 2005/0184114 A1 * 8/2005 Hoff A47D 13/025
224/160
- 2010/0155446 A1 * 6/2010 Stein A47D 13/025
224/159
- 2011/0089205 A1 * 4/2011 Coote A47D 13/025
224/160

- 2014/0263491 A1 * 9/2014 Telford A47D 13/025
224/160
- 2017/0150826 A1 * 6/2017 Salazar A47D 13/025
- 2017/0332806 A1 * 11/2017 Liu A47D 13/025
- 2019/0014920 A1 * 1/2019 Matsuyama A47D 13/025

FOREIGN PATENT DOCUMENTS

KR 300993837.0000 * 2/2019

OTHER PUBLICATIONS

Youtube.com, Site visited Sep. 1, 2022, "US-GL—Nuna CUDL Baby Carrier: Keep them close—Demo—6 Months & Older," posted by Nuna Global on Sep. 13, 2019 shows the Nuna Cudl Baby Carrier, https://www.youtube.com/watch?v=EV-QC18NF_w (Year: 2019).*

Amazon.ca, site visited Aug. 30, 2022, Ergobaby Omni 360 All Carry Positions Baby Carrier, first available Apr. 7, 2018, <https://www.amazon.ca/Ergobaby-Ergonomic-Carrier-Positions-Newborn/dp/B0743L6R1T> (Year: 2018).*

(Continued)

Primary Examiner — Brett Miller

Assistant Examiner — Jessica M Gebhart

(74) *Attorney, Agent, or Firm* — JCIP Global Inc.

(57) **CLAIM**

The ornamental design for an infant carrier, as shown and described.

DESCRIPTION

FIG. 1 is a perspective view of an infant carrier showing my new design;

FIG. 2 is a front view thereof;

FIG. 3 is a rear view thereof;

FIG. 4 is a right side view thereof;

FIG. 5 is a left side view thereof;

FIG. 6 is a top view thereof; and,

FIG. 7 is a bottom view thereof.

1 Claim, 7 Drawing Sheets

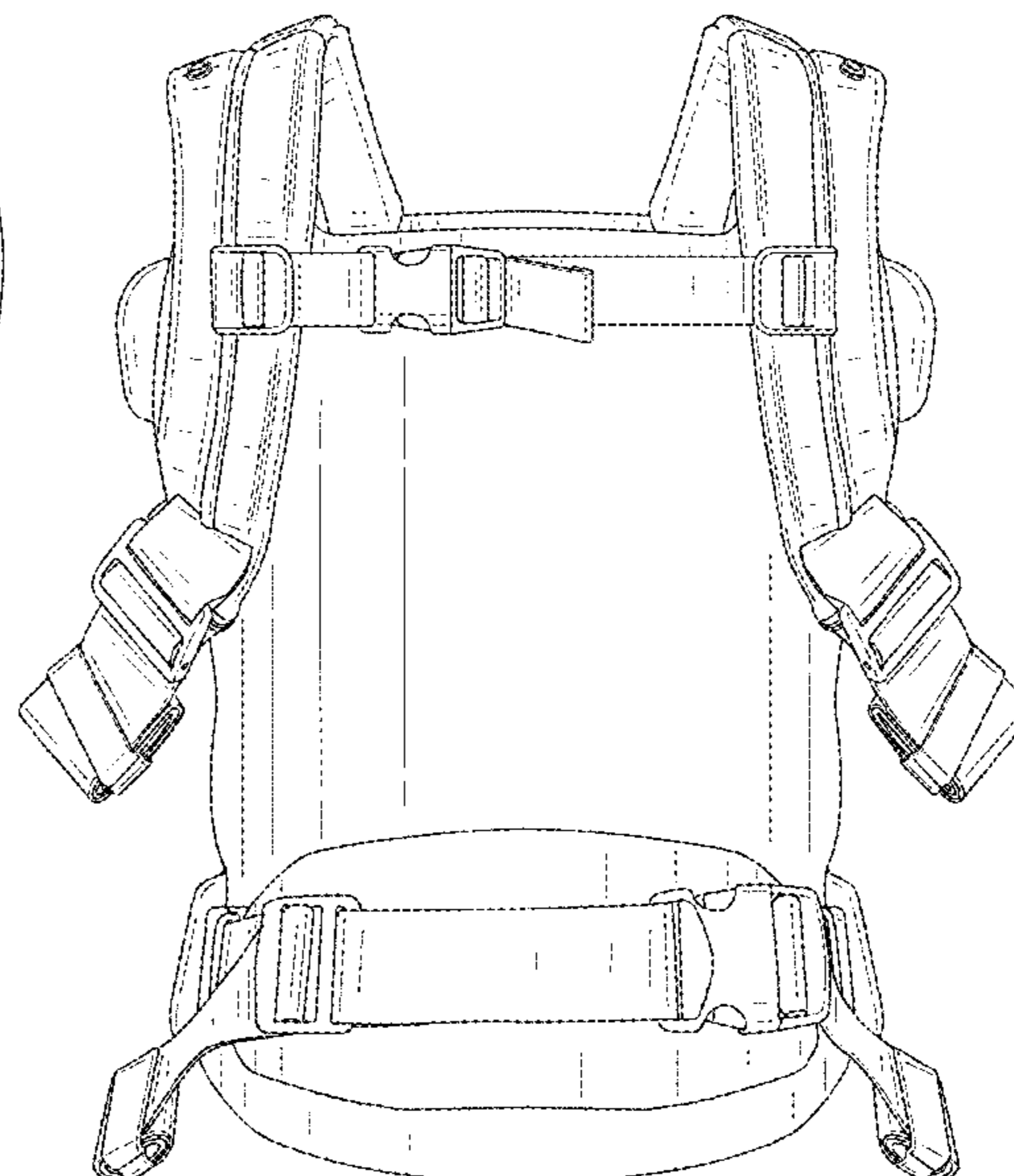
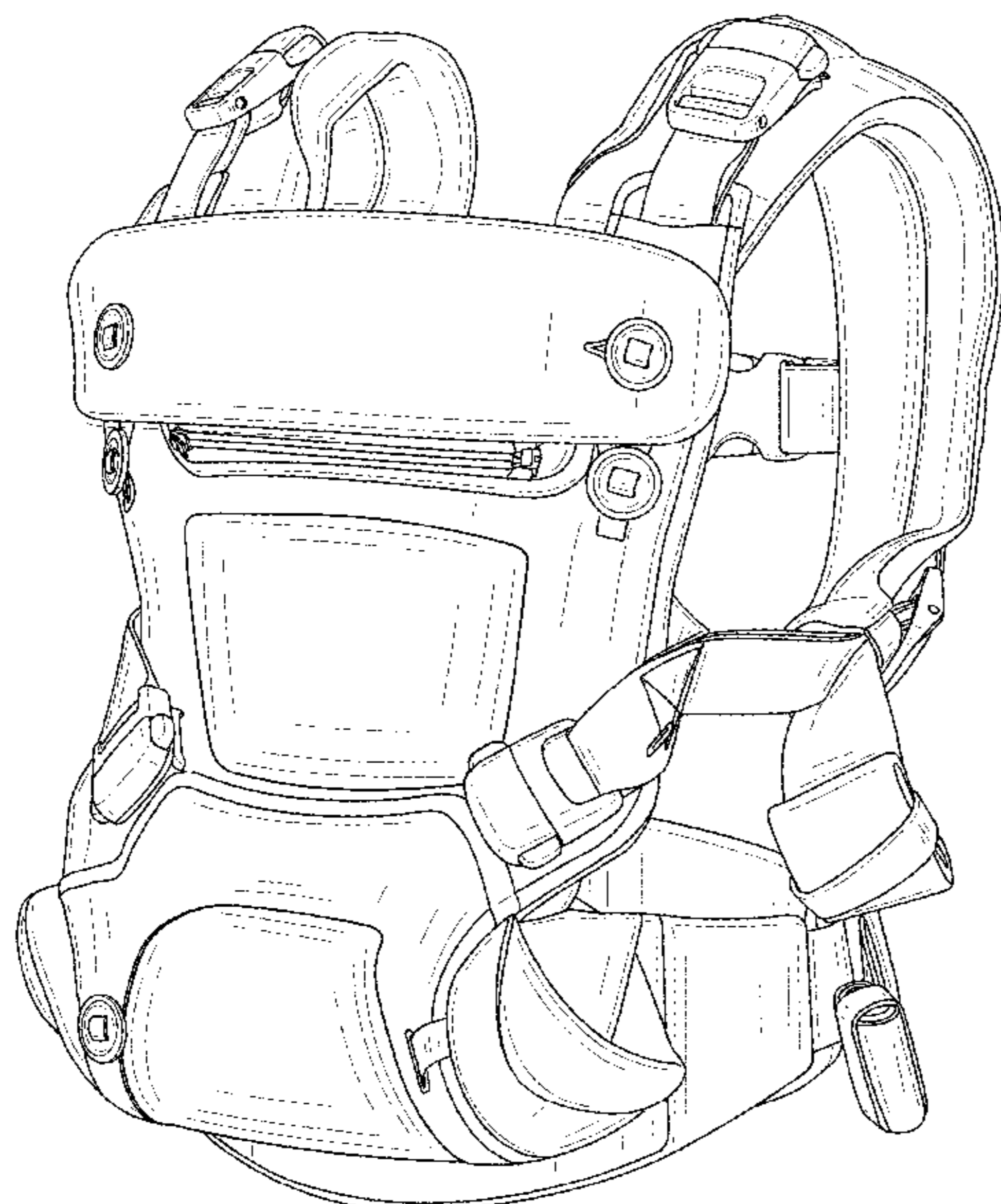

(56)

References Cited

OTHER PUBLICATIONS

Youtube.com, Site visited Aug. 30, 2022, "Which Baby Carrier Is Right For You?" published Mar. 19, 2018 by Ergobaby features the Erbobaby Original Carrier: <https://www.youtube.com/watch?v=61e0L4N3jvY> (Year: 2018).*

Amazon.ca, site visited Aug. 31, 2022, Lillebaby Six Position Baby Carrier, First available Mar. 5, 2015, <https://www.amazon.ca/SIX-Position-Ergonomic-Child-Carrier-LILLEbaby/dp/B00R6XEQR2> (Year: 2015).*

* cited by examiner

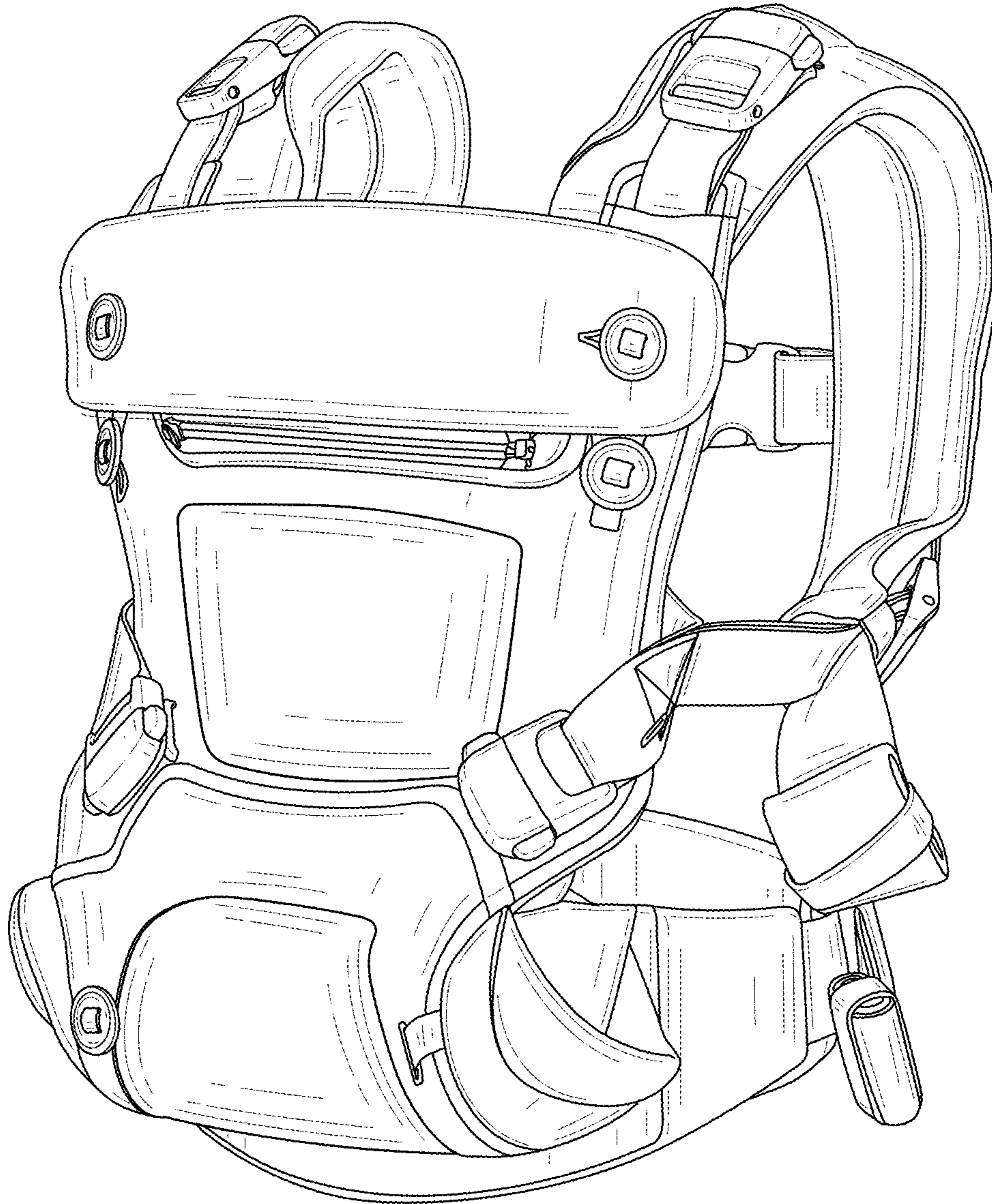

FIG. 1

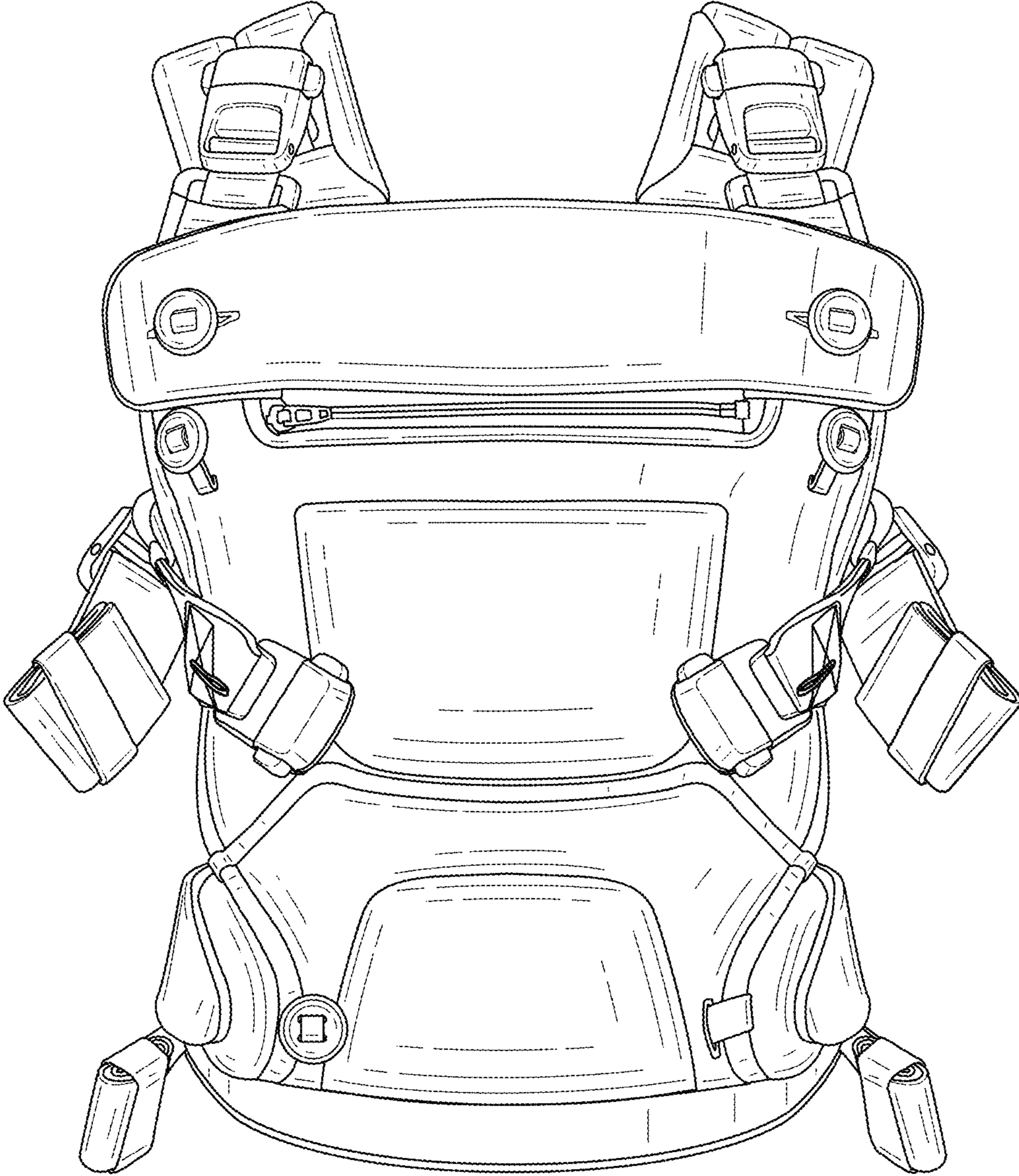

FIG. 2

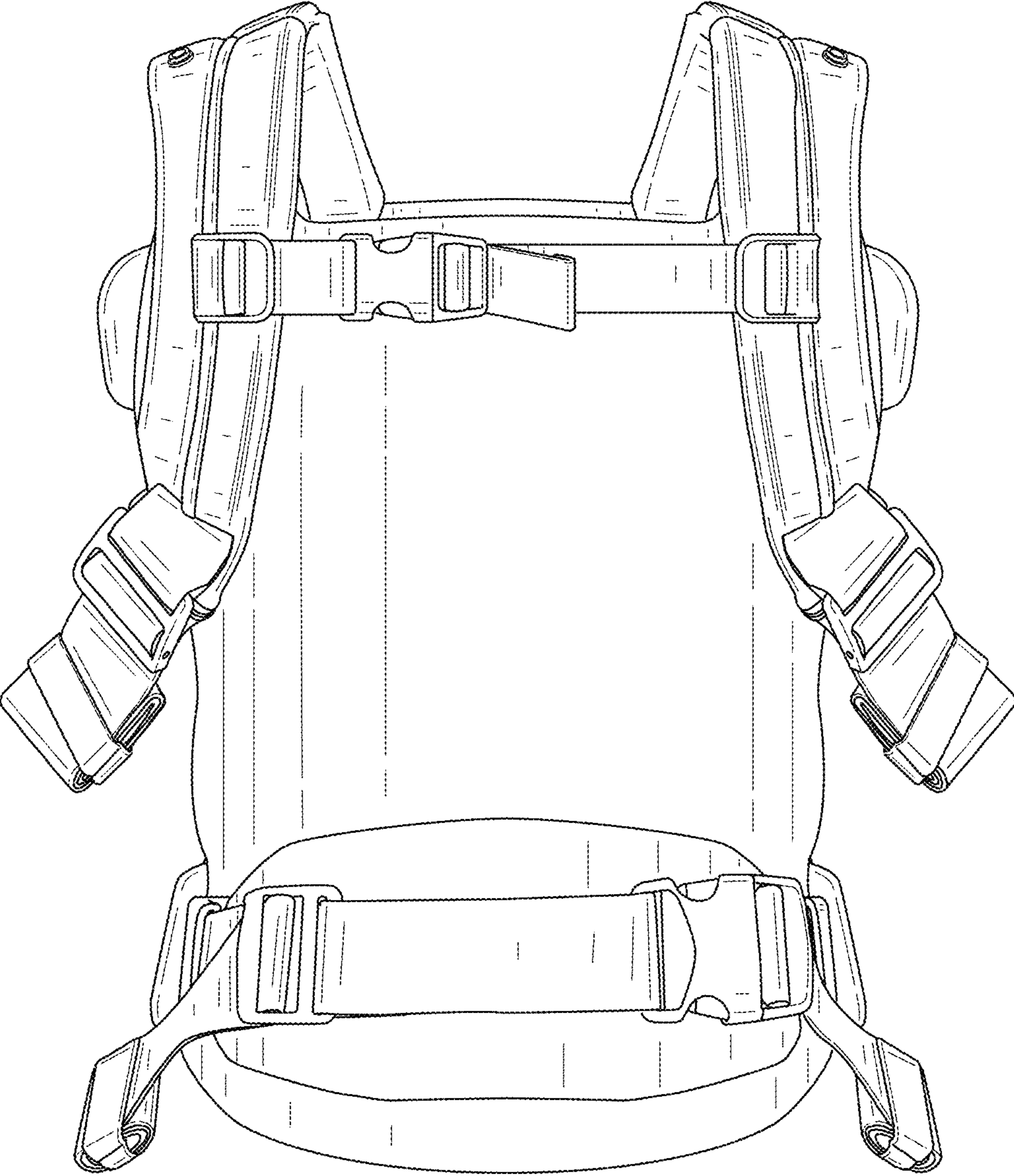

FIG. 3

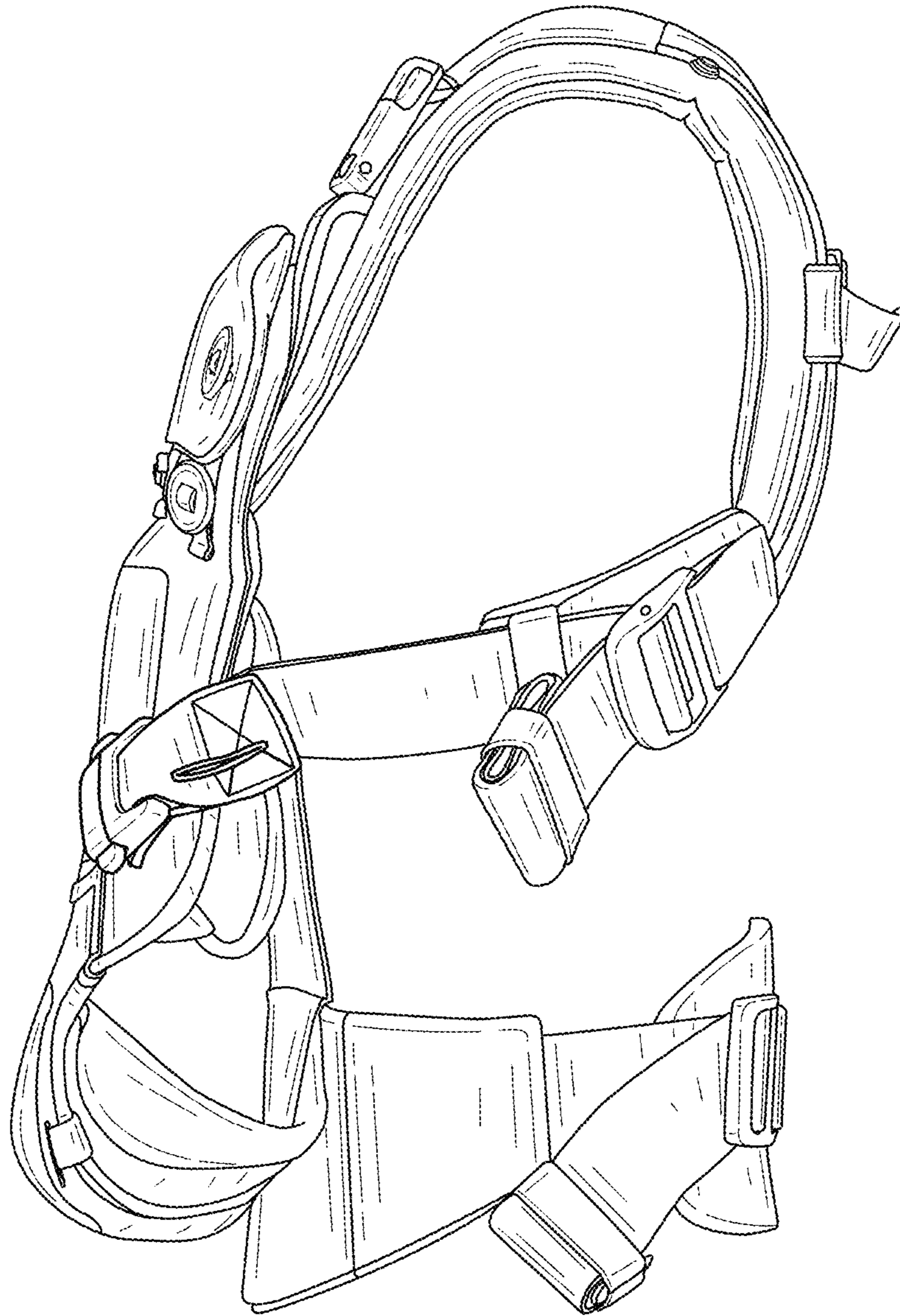

FIG. 4

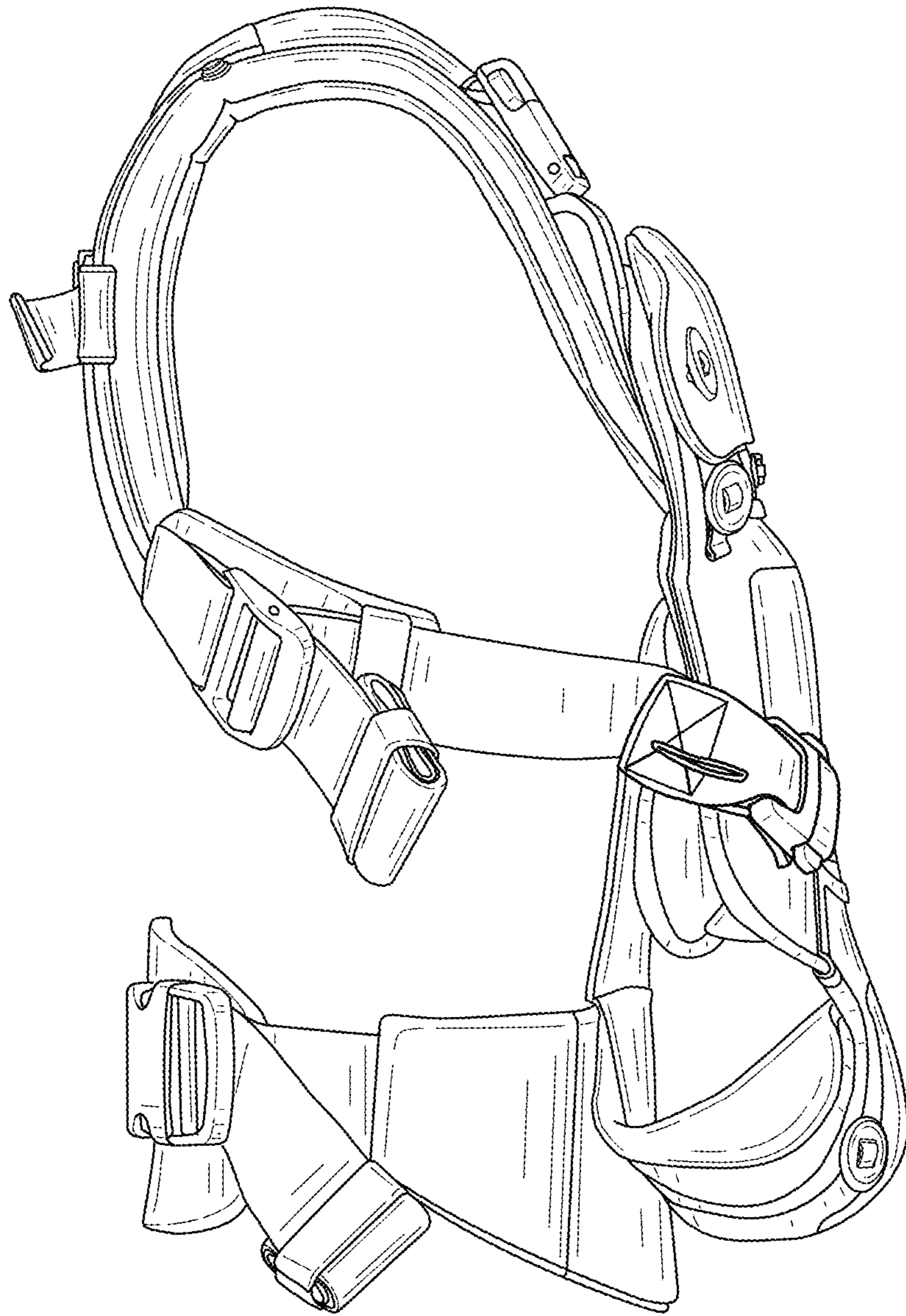

FIG. 5

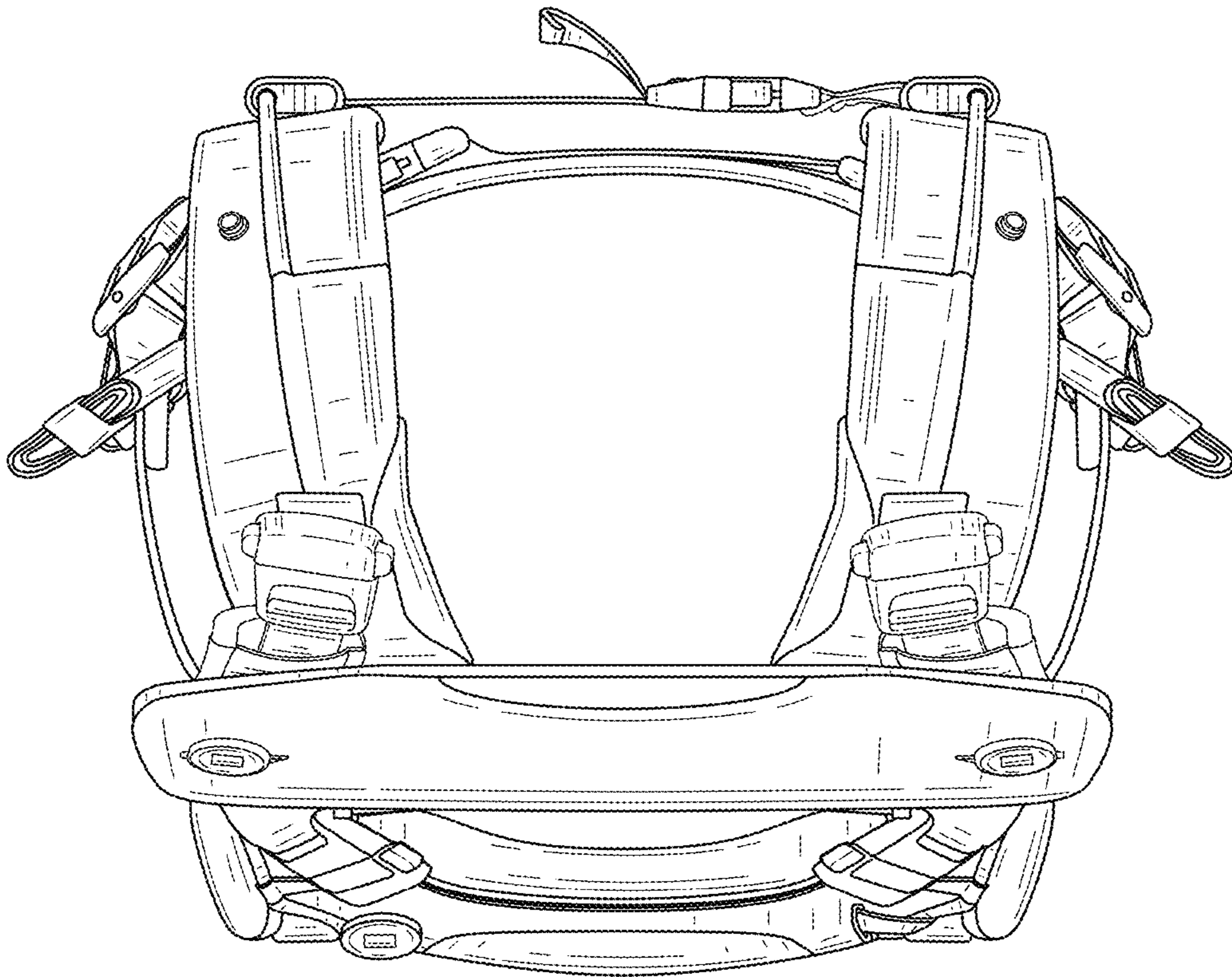

FIG. 6

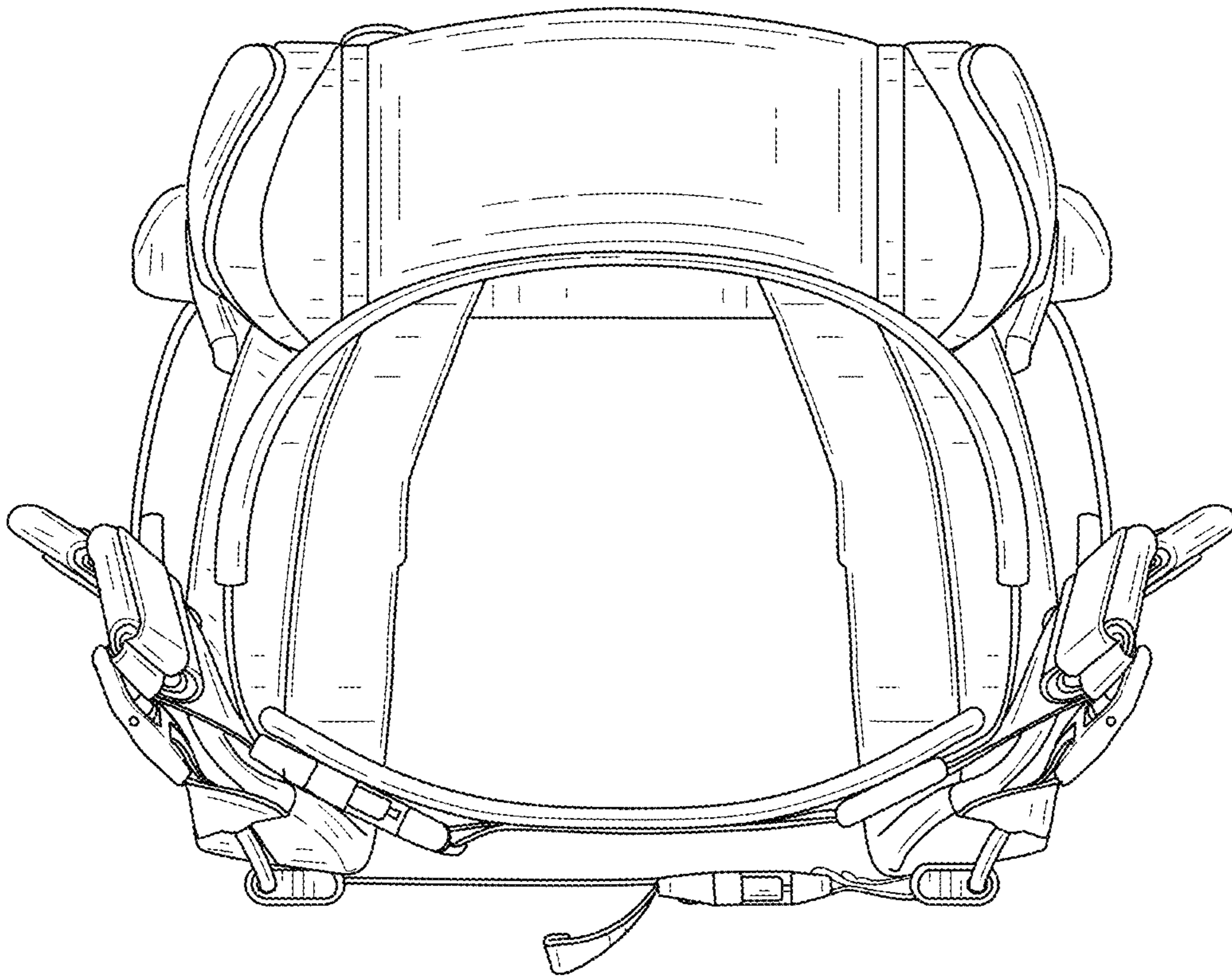

FIG. 7