



US00D984796S

(12) **United States Design Patent**
Fan

(10) **Patent No.:** **US D984,796 S**

(45) **Date of Patent:** **** *May 2, 2023**

(54) **INFANT CARRIER**

FOREIGN PATENT DOCUMENTS

(71) Applicant: **Wonderland Switzerland AG**,
Steinhausen (CH)

KR 300993837.0000 * 2/2019

(72) Inventor: **Meifeng Fan**, Dongguan (CN)

OTHER PUBLICATIONS

(73) Assignee: **Wonderland Switzerland AG**,
Steinhausen (CH)

Amazon.ca, site visited Aug. 31, 2022, Lillebaby Six Position Baby Carrier, First available Mar. 5, 2015, <https://www.amazon.ca/SIX-Position-Ergonomic-Child-Carrier-LILLEbaby/dp/B00R6XEQR2> (Year: 2015).*

(*) Notice: This patent is subject to a terminal disclaimer.

Youtube.com, Site visited Aug. 30, 2022, "Which Baby Carrier Is Right For You?" published Mar. 19, 2018 by Ergobaby features the 360 carrier and the Ergobaby Adapt Carrier: <https://www.youtube.com/watch?v=61e0L4N3jvY> (Year: 2018).*

(**) Term: **15 Years**

Amazon.ca, site visited Aug. 30, 2022, Ergobaby Omni 360 All Carry Positions Baby Carrier, first available Apr. 7, 2018, <https://www.amazon.ca/Ergobaby-Ergonomic-Carrier-Positions-Newborn/dp/B0743L6R1T> (Year: 2018).*

(21) Appl. No.: **29/779,019**

Amazon.ca, Site visited Aug. 30, 2022, Beco Gemini Baby Carrier, First available Feb. 5, 2019, <https://www.amazon.ca/dp/B07NYR1L4W> (Year: 2019).*

(22) Filed: **Apr. 15, 2021**

(30) **Foreign Application Priority Data**

Oct. 16, 2020 (CN) 202030616484.9

* cited by examiner

(51) **LOC (14) Cl.** **03-05**

Primary Examiner — Brett Miller

(52) **U.S. Cl.**

Assistant Examiner — Jessica M Gebhart

USPC **D3/214**; D3/213

(74) *Attorney, Agent, or Firm* — JCIP Global Inc.

(58) **Field of Classification Search**

USPC D3/213, 214, 215, 216; D7/719; D6/333

CPC A47D 13/025; A47D 13/02; A61G 1/00

See application file for complete search history.

(57) **CLAIM**

The ornamental design for an infant carrier, as shown and described.

(56) **References Cited**

DESCRIPTION

U.S. PATENT DOCUMENTS

D655,495 S *	3/2012	Sauer	D3/214
D693,569 S *	11/2013	Lehan	D3/214
D698,142 S *	1/2014	Cha	D3/214
10,264,895 B2 *	4/2019	Lindeman	A47D 13/025
D849,397 S *	5/2019	Tsai	D3/214
11,019,941 B2 *	6/2021	Salazar	A47D 13/025
2014/0263491 A1 *	9/2014	Telford	A47D 13/025
				224/160
2017/0119173 A1 *	5/2017	Telford	A47D 13/025
2017/0150826 A1 *	6/2017	Salazar	A47D 13/025
2019/0014920 A1 *	1/2019	Matsuyama	A47D 13/025
2020/0253392 A1 *	8/2020	Sahadi	A47D 13/025

FIG. 1 is a perspective view of an infant carrier showing my new design;
FIG. 2 is a front view thereof;
FIG. 3 is a rear view thereof;
FIG. 4 is a right side view thereof;
FIG. 5 is a left side view thereof;
FIG. 6 is a top view thereof; and,
FIG. 7 is a bottom view thereof.

1 Claim, 7 Drawing Sheets

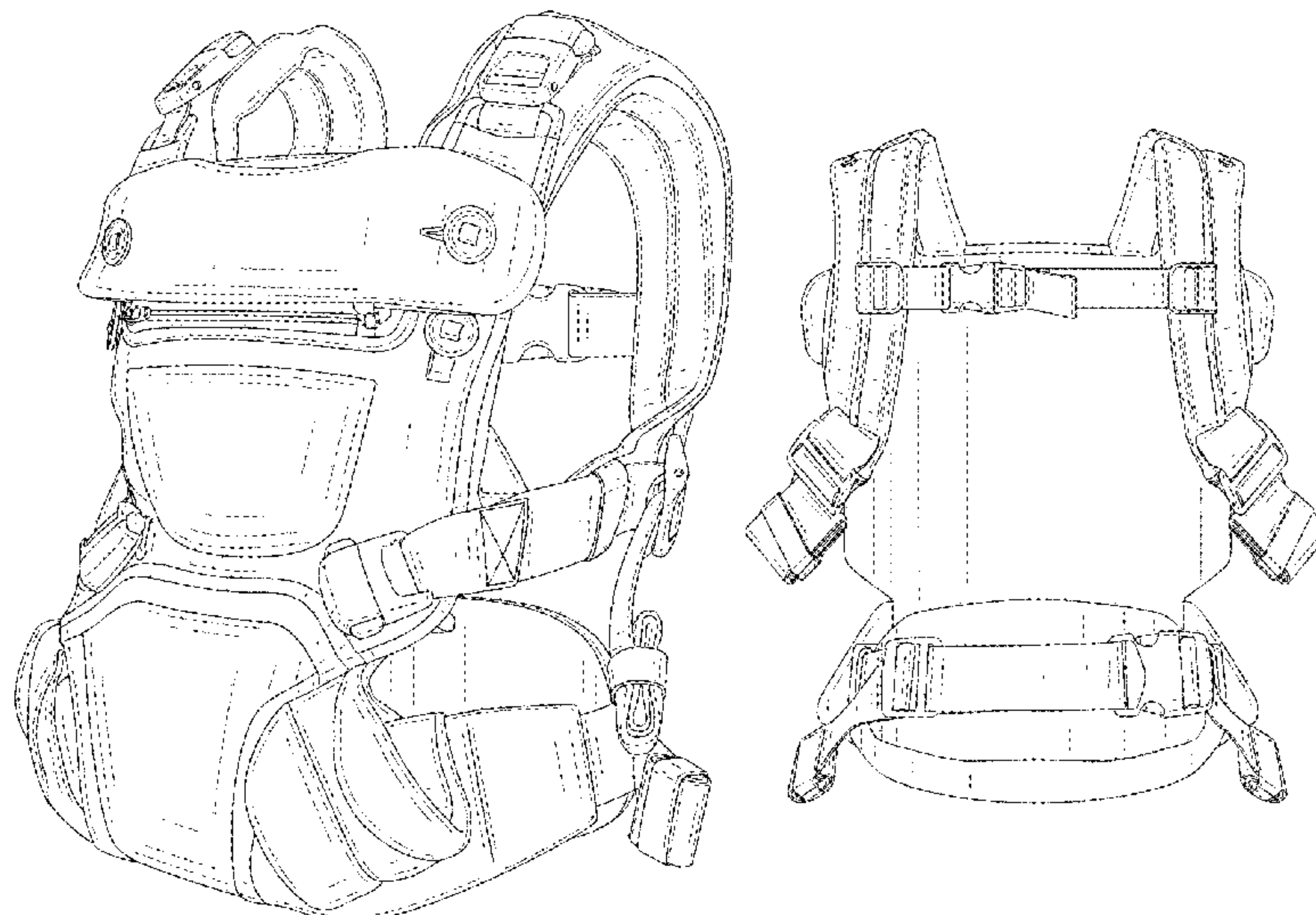



FIG. 1

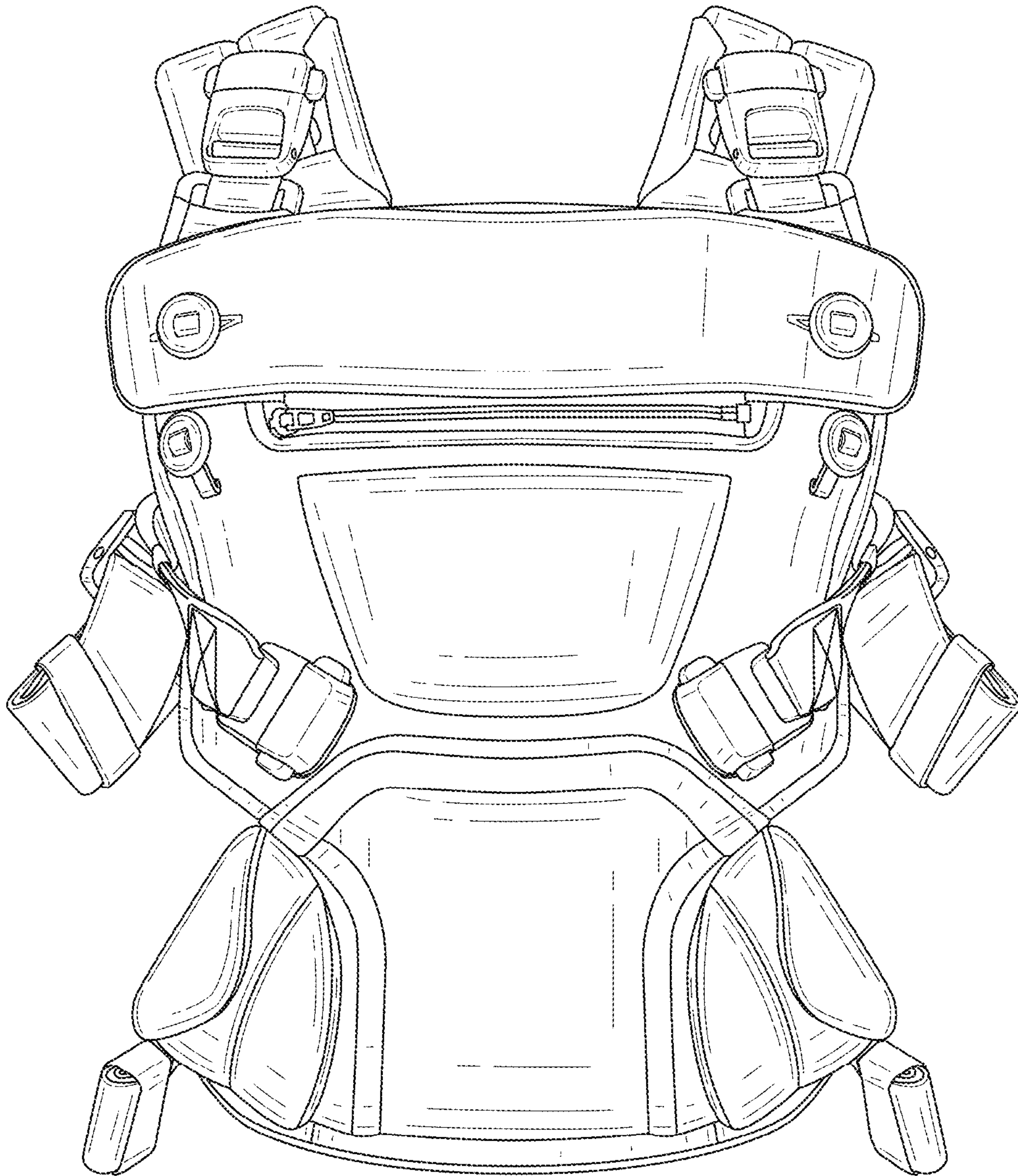

FIG. 2

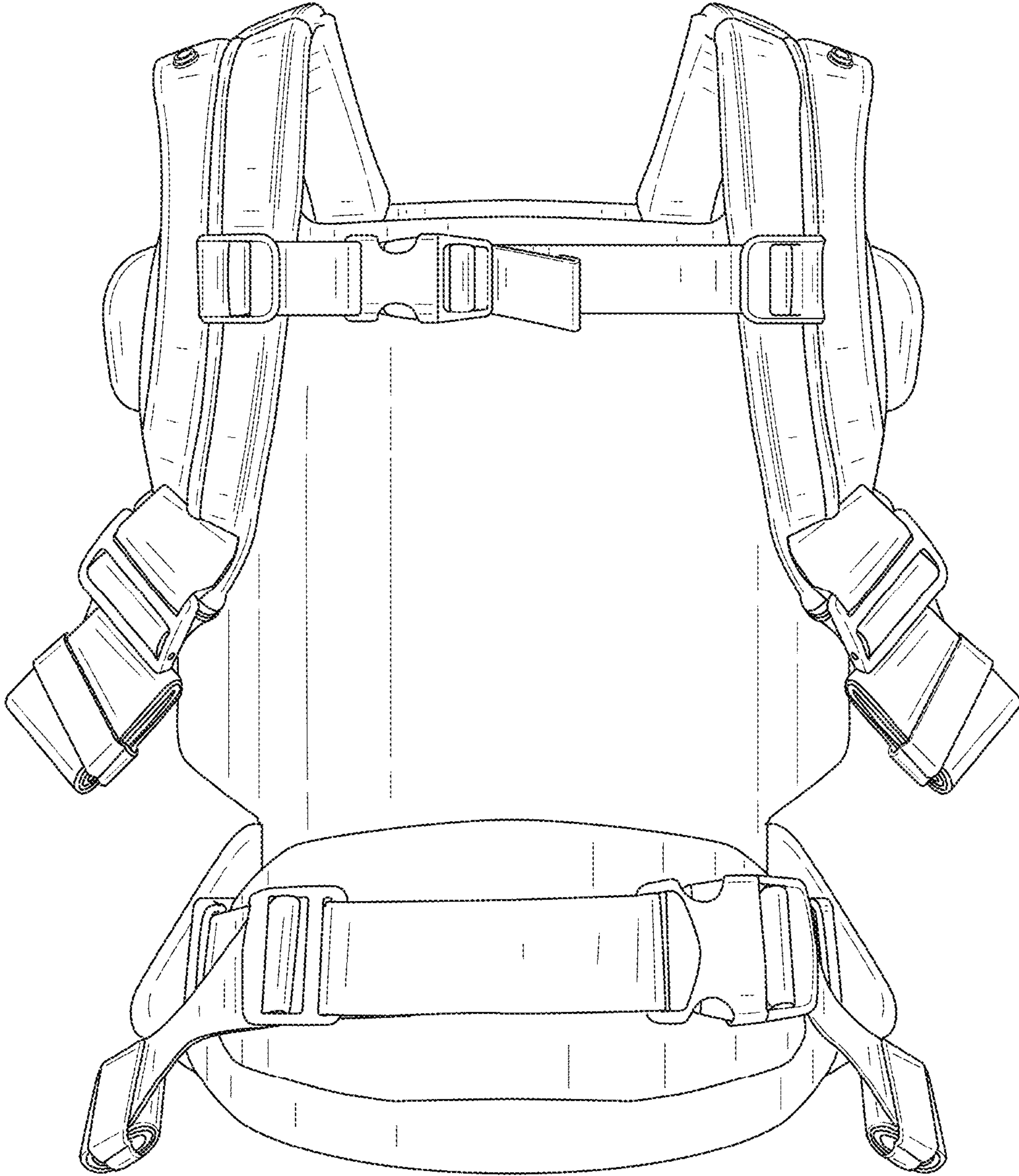

FIG. 3

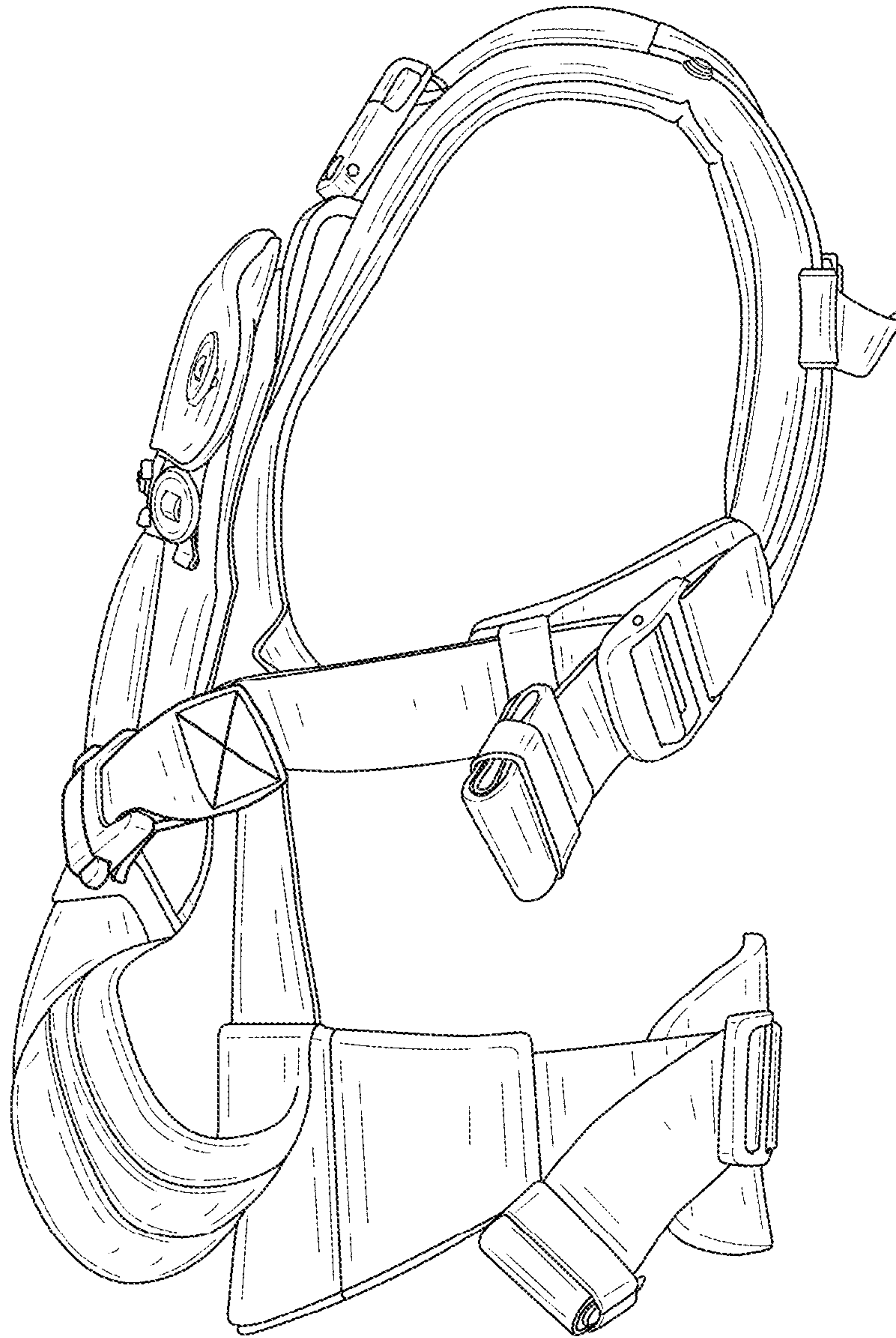

FIG. 4

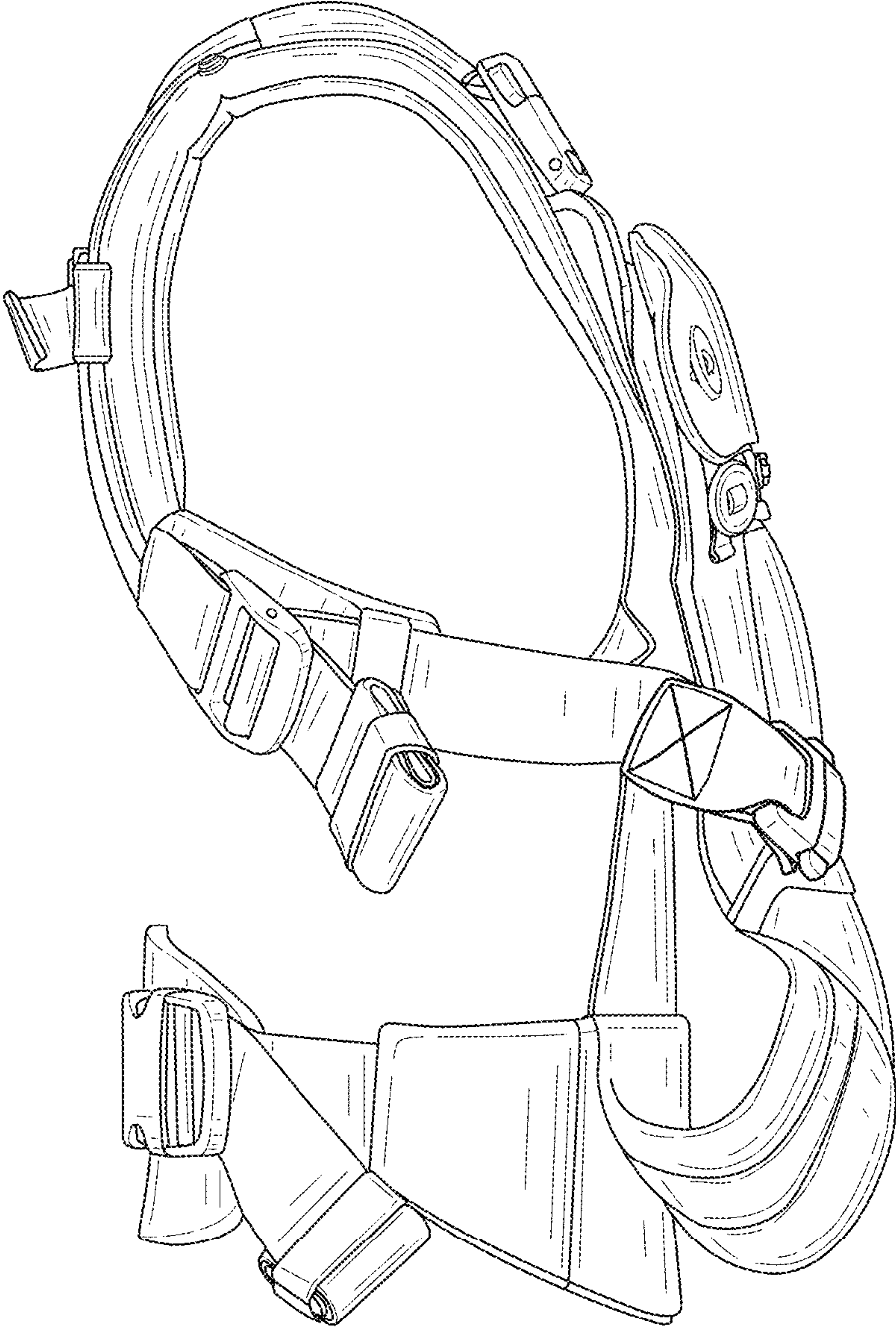

FIG. 5

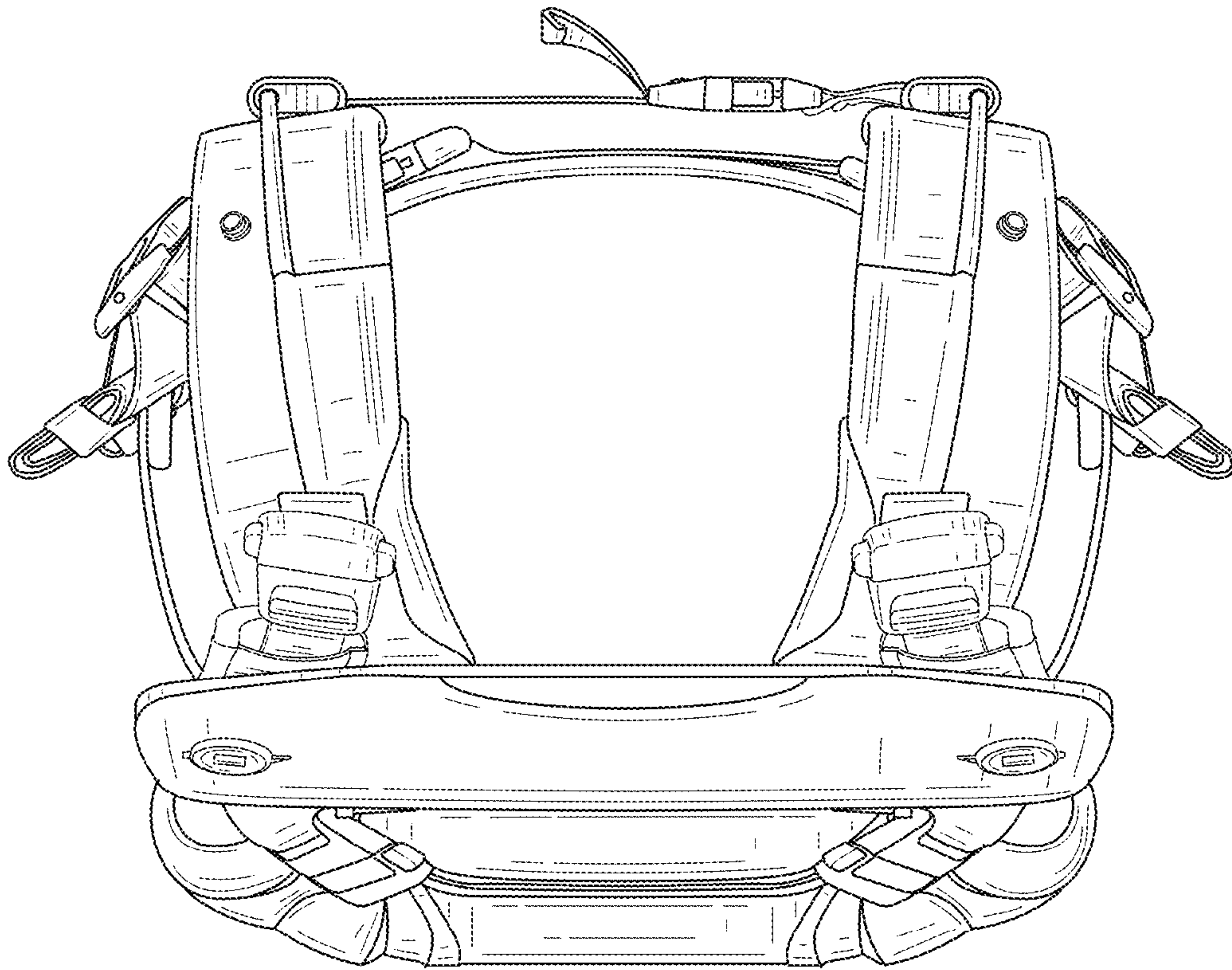

FIG. 6

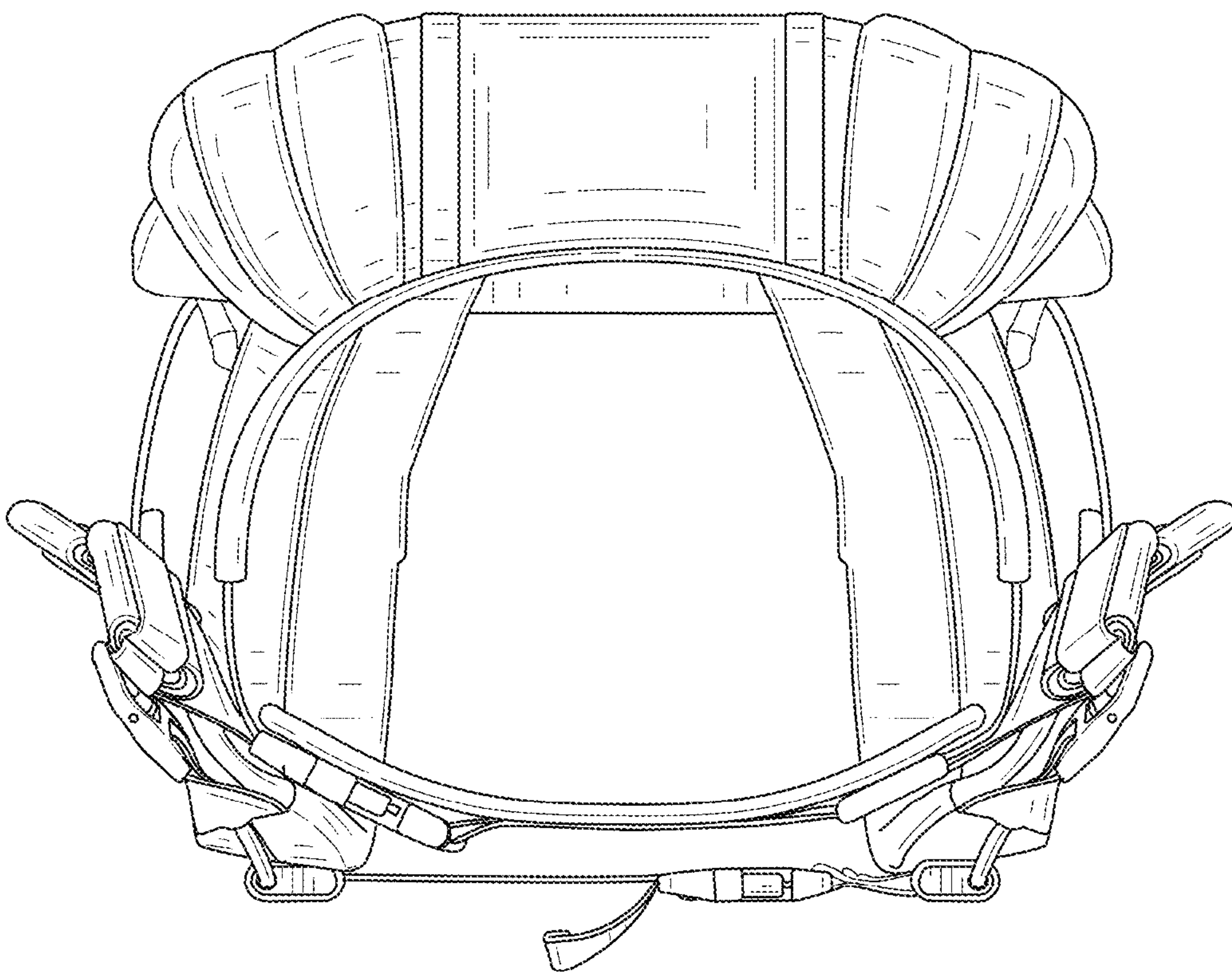

FIG. 7