



US00D984735S

(12) **United States Design Patent** (10) **Patent No.:** **US D984,735 S**
Jin (45) **Date of Patent:** **** Apr. 25, 2023**

(54) **CIGARETTE PACKET**
(71) Applicants: **Shanghai New Tobacco Product Research Institute Co., Ltd., Shanghai (CN); Shanghai Tobacco Group Co., Ltd., Shanghai (CN)**

D462,139 S * 8/2002 Sagmeister D27/189
D487,532 S * 3/2004 Draghetti D27/189
D492,814 S * 7/2004 Bray D27/189
D492,815 S * 7/2004 Bray D27/189
D500,387 S * 12/2004 Draghetti D27/189
D503,827 S * 4/2005 Cahill D27/189

(Continued)

(72) Inventor: **Zhaodan Jin, Shanghai (CN)**
(73) Assignees: **Shanghai New Tobacco Product Research Institute Co., Ltd., Shanghai (CN); Shanghai Tobacco Group Co., Ltd., Shanghai (CN)**

OTHER PUBLICATIONS

Cigarette Holder and Pack Case By: Visol found on Amazon (Dec. 15, 2022) https://www.amazon.com/Visol-Silicon-Reusable-Non-Toxic-Cigarette/dp/B076FCMV9X/ref=sr_1_29?crd=XNBBRUIMYIET&keywords=cigarette%2Bpacket&qid= (Oct. 12, 2017).*

(**) Term: **15 Years**
(21) Appl. No.: **29/786,120**
(22) Filed: **May 28, 2021**

Primary Examiner — Rebecca Tsehaye
(74) *Attorney, Agent, or Firm* — Taft Stettinius & Hollister, LLP

(30) **Foreign Application Priority Data**
Dec. 1, 2020 (CN) 202030734076.3
(51) **LOC (14) Cl.** **27-06**
(52) **U.S. Cl.**
USPC **D27/172**
(58) **Field of Classification Search**
USPC D27/172, 101, 183, 186, 187, 189, 191;
D3/274; D7/629; D9/643, 648, 414-418,
D9/430, 432, 420, 423, 422
CPC A24F 15/12; B65D 85/10; B65D 85/1045;
B65D 85/1056; B65D 85/08
See application file for complete search history.

(57) **CLAIM**
The ornamental design for a cigarette packet, as shown and described.

DESCRIPTION

FIG. 1 is a front top perspective view of a cigarette packet of the present invention.
FIG. 2 is a back top perspective view of a cigarette packet of the present invention.
FIG. 3 is a front view of a cigarette packet of the present invention.
FIG. 4 is a rear view of a cigarette packet of the present invention.
FIG. 5 is a left view of a cigarette packet of the present invention.
FIG. 6 is a right view of a cigarette packet of the present invention.
FIG. 7 is a top view of a cigarette packet of the present invention; and,
FIG. 8 is a bottom view of a cigarette packet of the present invention.

(56) **References Cited**
U.S. PATENT DOCUMENTS
3,976,194 A * 8/1976 Loredo B65D 85/109
206/87
D296,938 S * 7/1988 Ameringen D9/423
D319,975 S * 9/1991 Mallon D9/418
D394,385 S * 5/1998 Laughlin D9/431
5,833,060 A * 11/1998 Draghetti B65D 85/1048
206/268

1 Claim, 5 Drawing Sheets

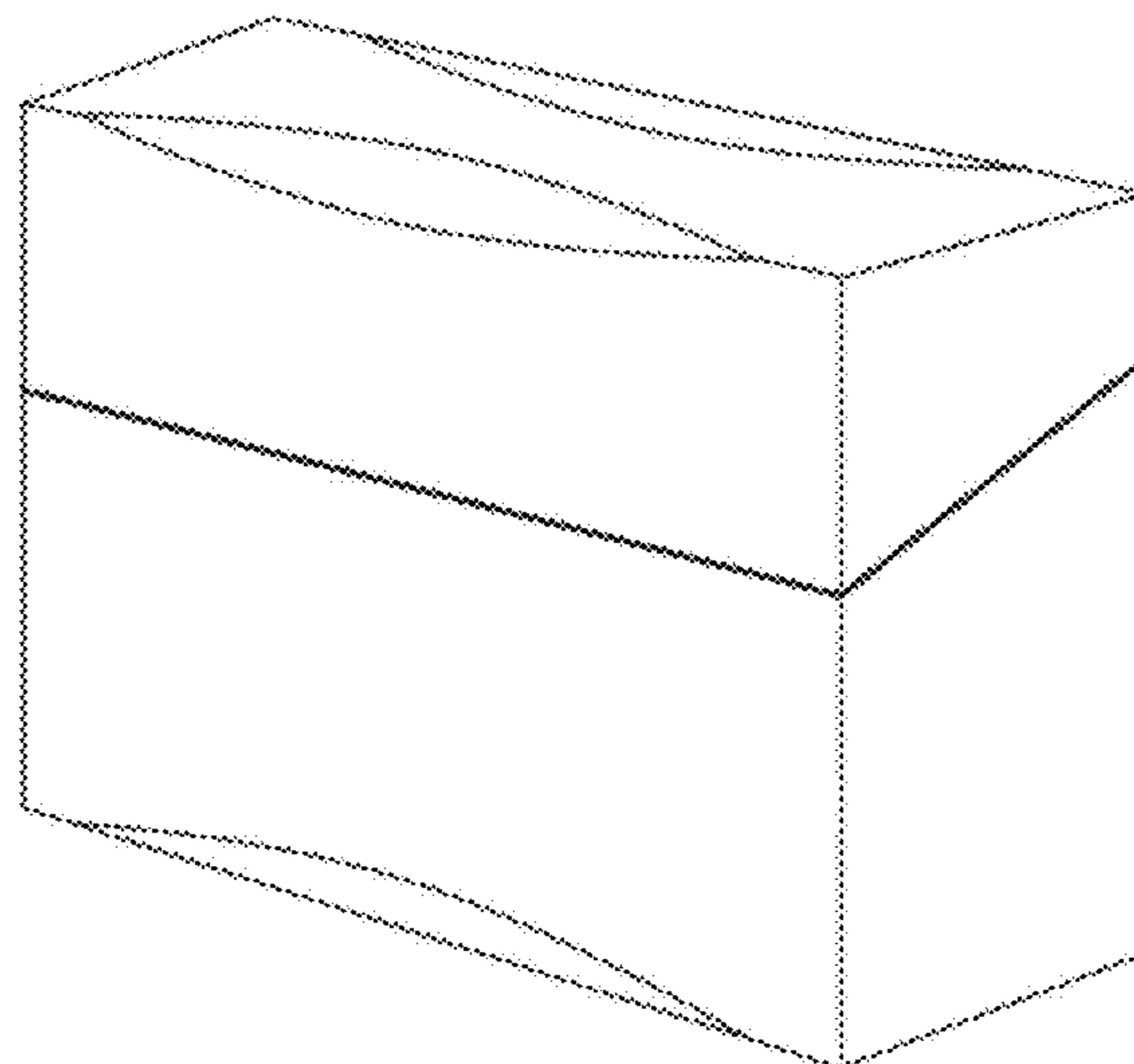

(56)

References Cited

U.S. PATENT DOCUMENTS

D578,385	S	*	10/2008	Ancona	D9/423
7,455,177	B2	*	11/2008	Serafini	B65D 75/5833 206/268
D591,898	S	*	5/2009	McKenzie	D27/189
D591,899	S	*	5/2009	Bray	D27/189
D598,745	S	*	8/2009	Bohache	D9/430
D607,318	S	*	1/2010	Collins	B65D 85/10 D9/423
D675,916	S	*	2/2013	Villiers	D9/431
D728,364	S	*	5/2015	Baker	D9/432
D775,944	S	*	1/2017	Marchitto	B65D 5/6694 D9/414
D833,065	S	*	11/2018	Alarcon	D27/186
D847,660	S	*	5/2019	Schumaker	D9/416
D877,972	S	*	3/2020	Kahawaiolaa	D27/101
D889,976	S	*	7/2020	Iura	D9/600
D909,865	S	*	2/2021	Yeung	D27/189
D936,475	S	*	11/2021	Kahawaiolaa	D9/420
2014/0305821	A1	*	10/2014	Gibson	B65D 5/5415 206/268

* cited by examiner

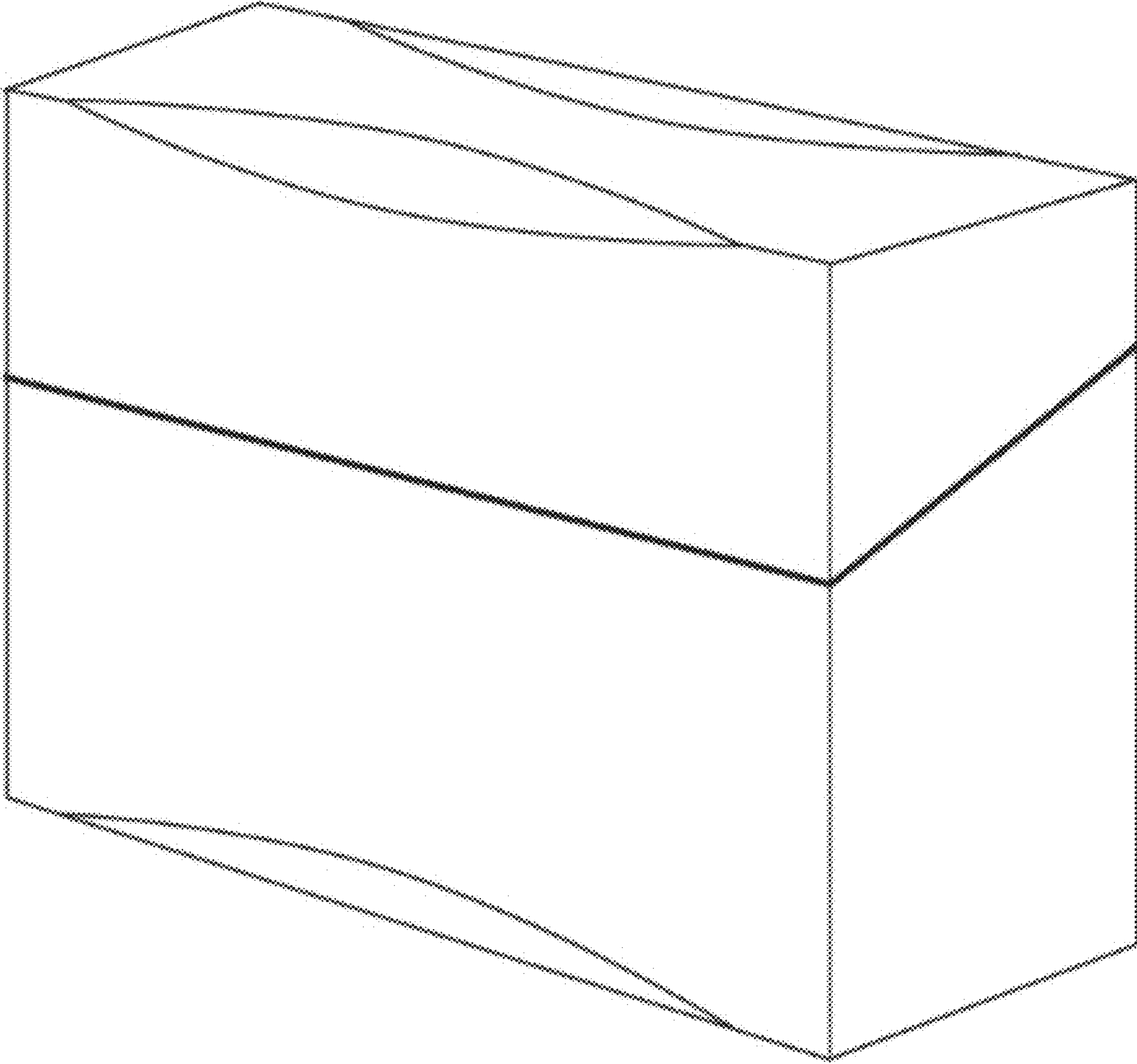

FIG. 1

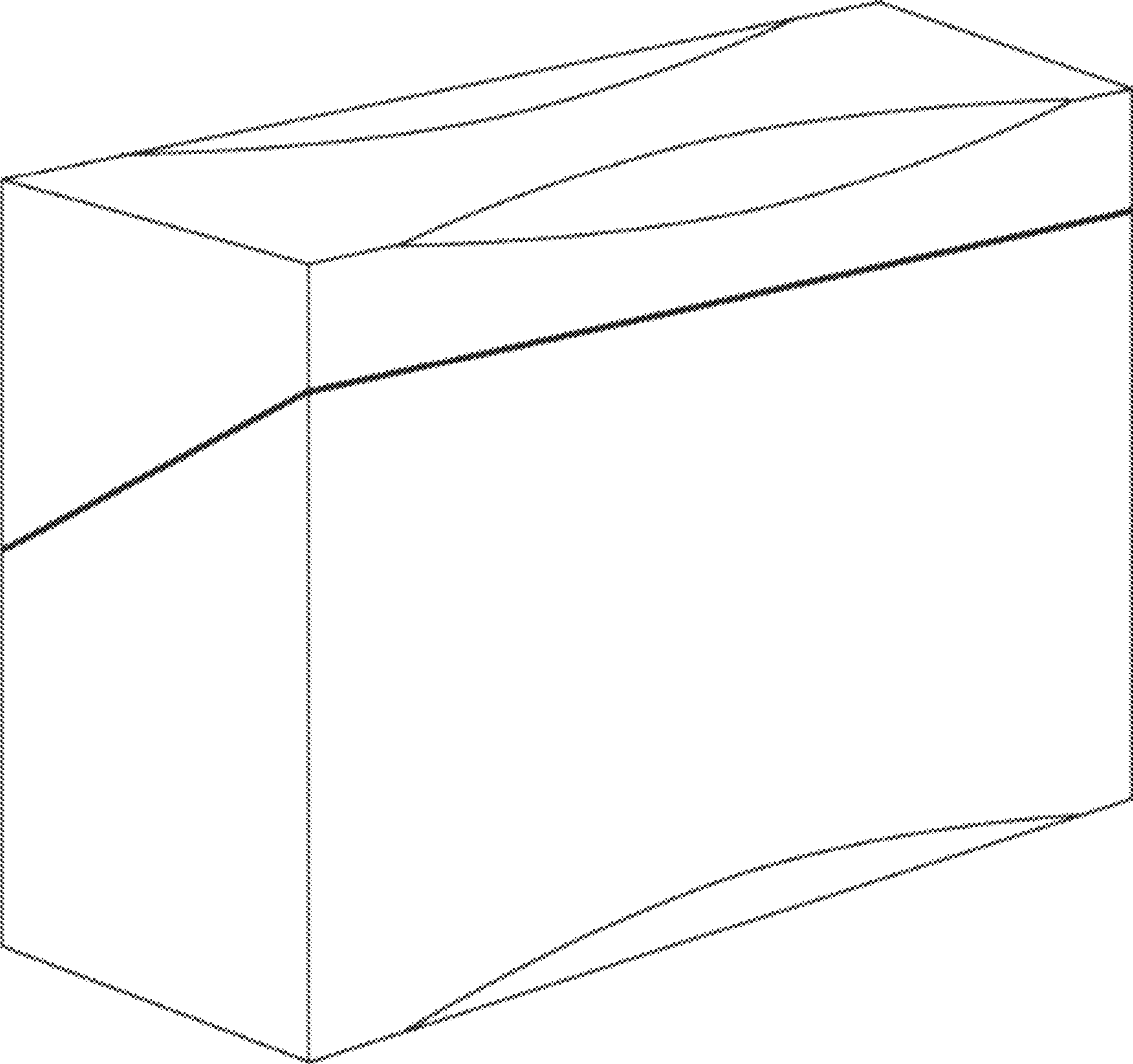

FIG. 2

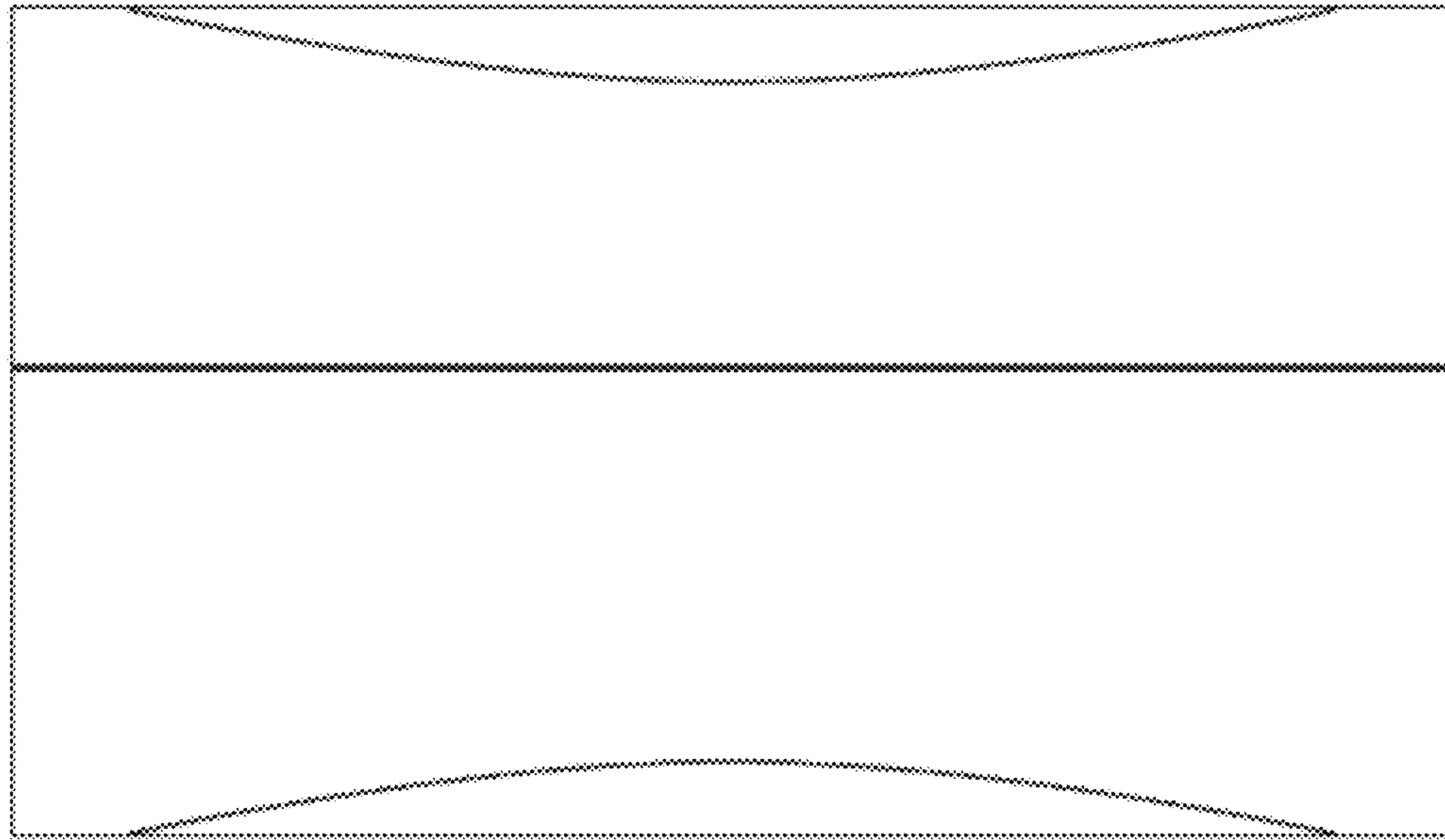

FIG. 3

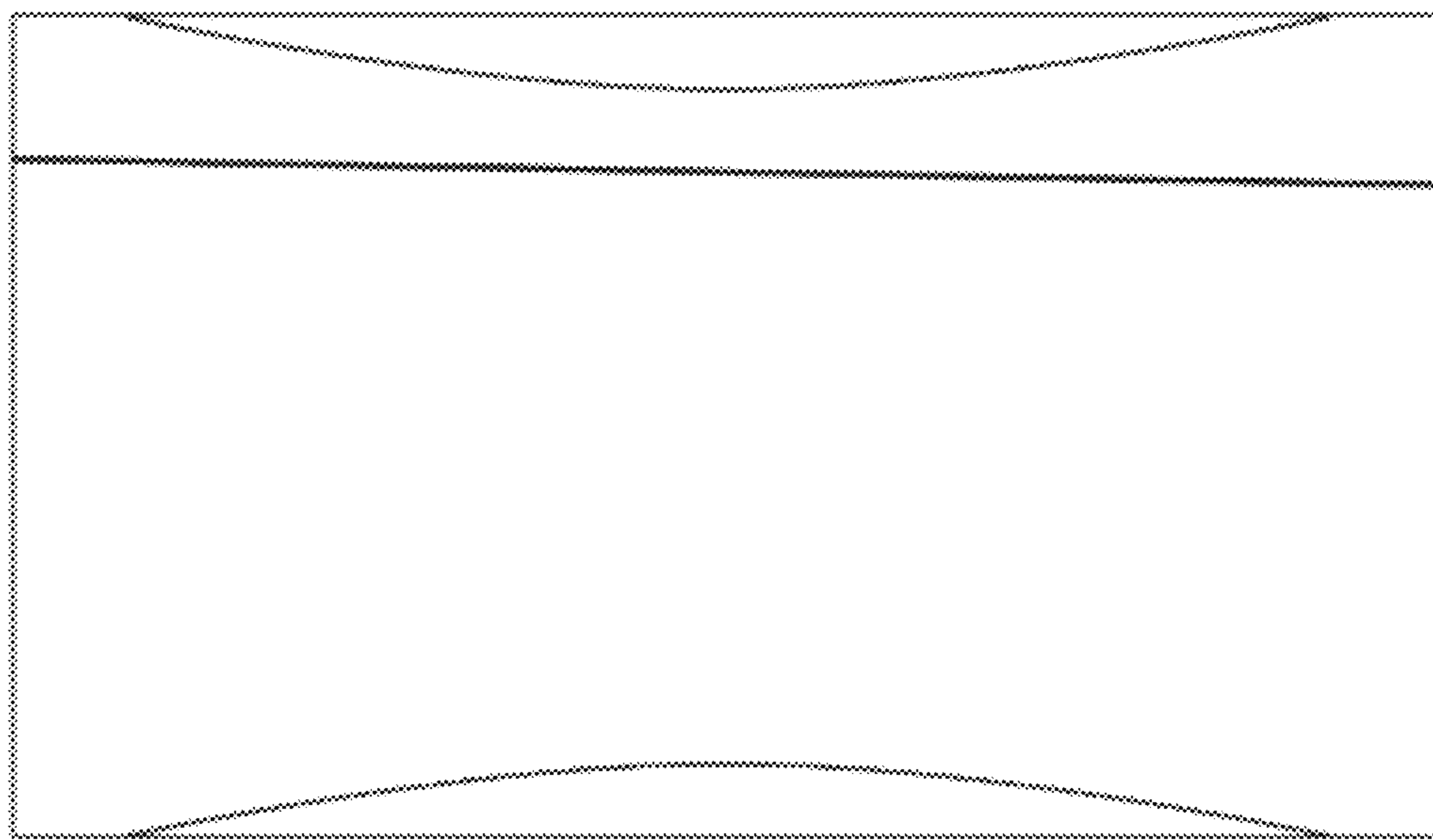

FIG. 4

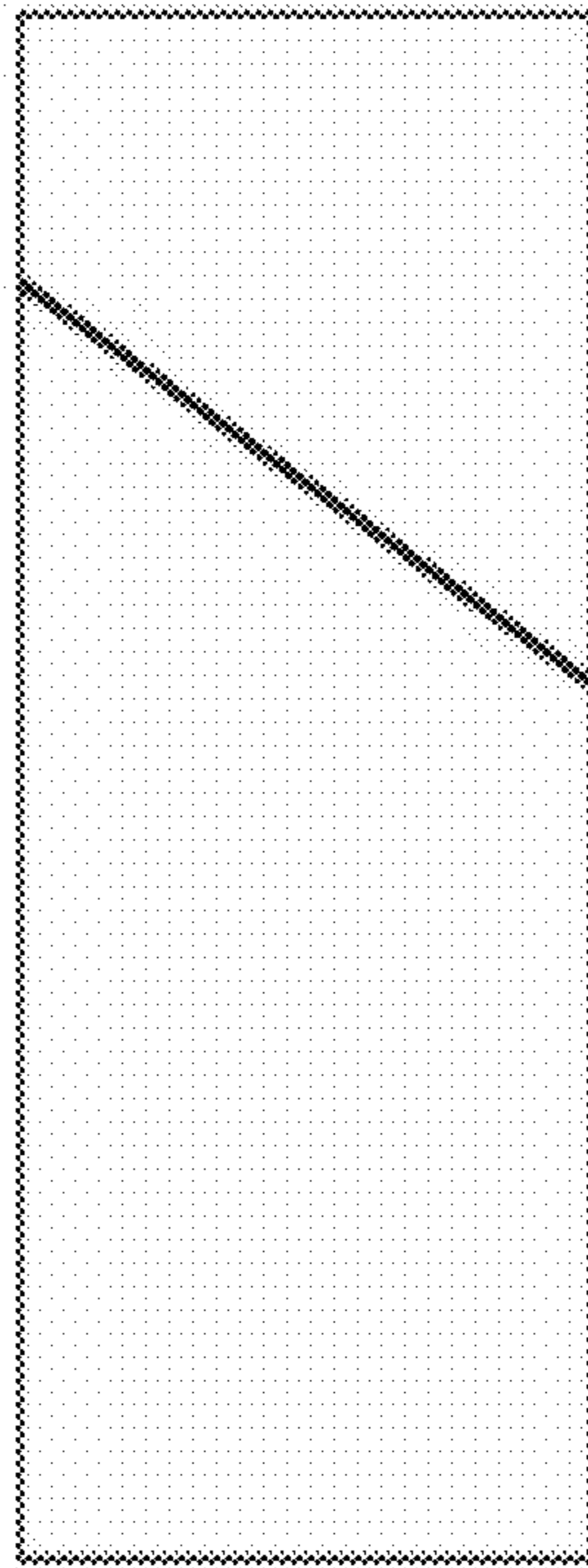

FIG. 5

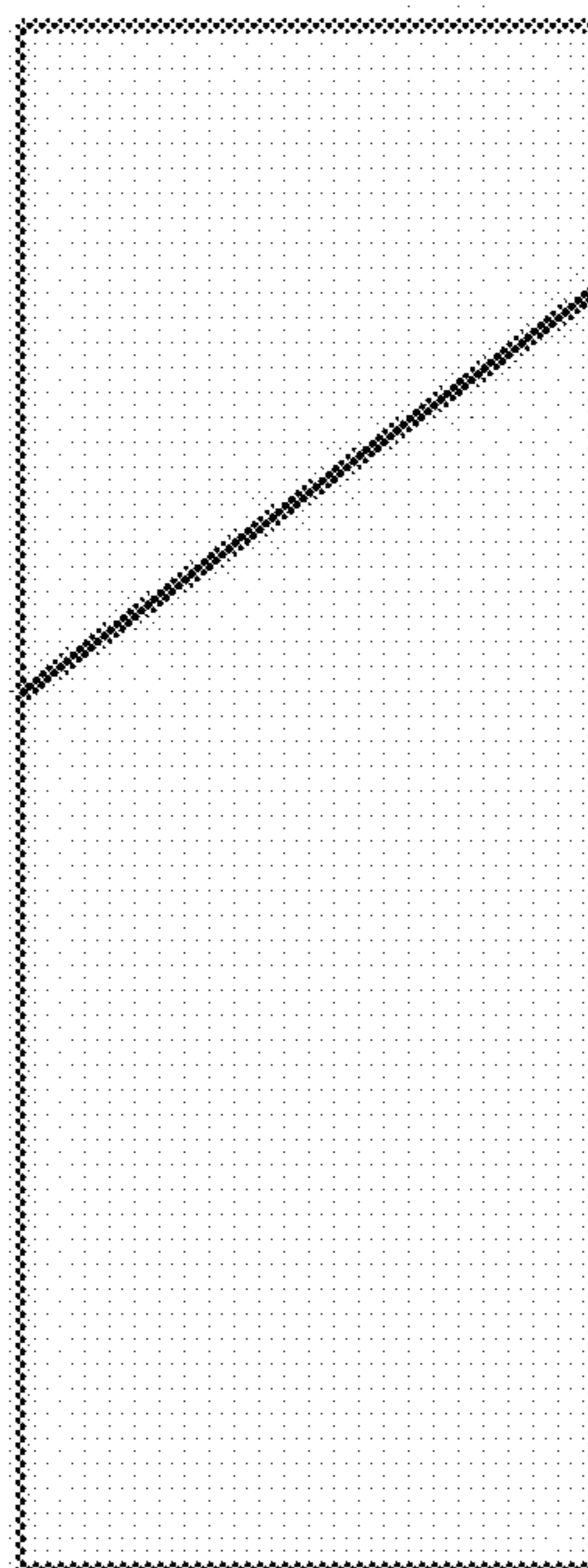

FIG. 6

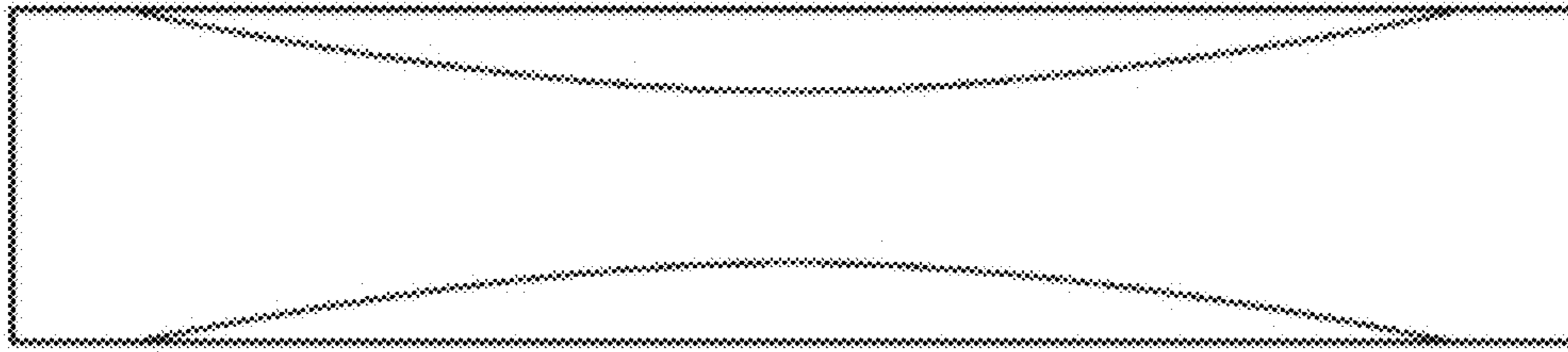

FIG. 7

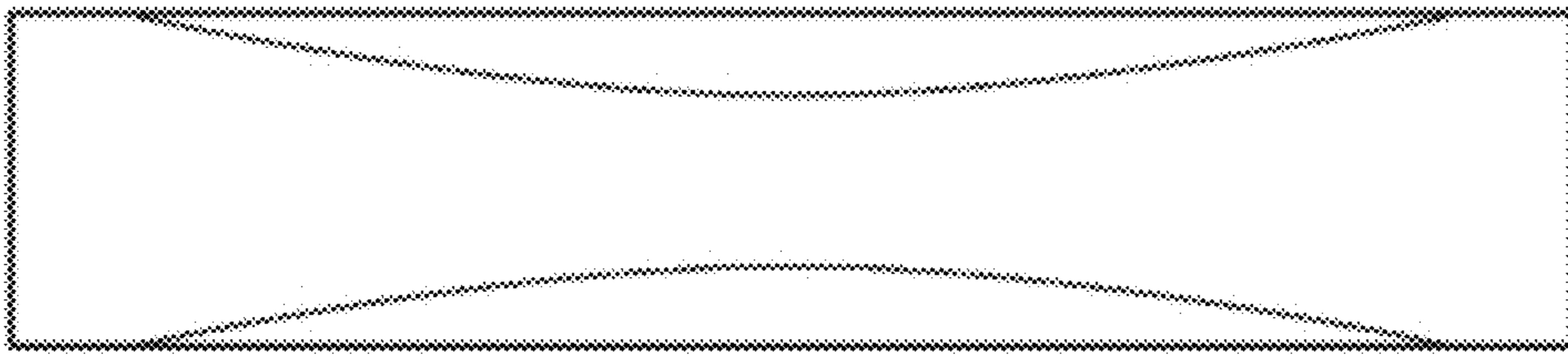

FIG. 8