



US00D984723S

(12) **United States Design Patent**
Chen

(10) **Patent No.:** **US D984,723 S**

(45) **Date of Patent:** **** Apr. 25, 2023**

(54) **VANITY LIGHT FIXTURE**

(71) Applicant: **Dongchun Chen**, Hunan Province (CN)

(72) Inventor: **Dongchun Chen**, Hunan Province (CN)

(**) Term: **15 Years**

(21) Appl. No.: **29/884,133**

(22) Filed: **Feb. 8, 2023**

(51) **LOC (14) Cl.** **26-05**

(52) **U.S. Cl.**
USPC **D26/128; D26/89**

(58) **Field of Classification Search**
USPC D26/24, 72-92, 113, 118-120, 125, 128,
D26/138

CPC F21Y 2115/10; F21S 8/033; F21S 8/036;
F21S 8/026; F21S 8/024; F21S 8/04;
F21S 8/00; F21S 13/02; F21V 21/30;
F21W 2121/00

See application file for complete search history.

(56) **References Cited**

U.S. PATENT DOCUMENTS

D536,308 S	2/2007	Inoue	
D656,654 S *	3/2012	Wauters	D26/89
D668,374 S *	10/2012	Wauters	D26/89
D679,437 S *	4/2013	Watt	D26/74
D702,868 S *	4/2014	Patel	D26/74
D731,111 S *	6/2015	Chen	D26/128

D731,692 S *	6/2015	Boyer	D26/74
D759,287 S *	6/2016	Chen	D26/128
D834,235 S *	11/2018	Gambrel	D26/89
D898,118 S *	10/2020	Jo	D14/374
D908,945 S *	1/2021	Zheng	D26/86
D950,829 S *	5/2022	Lin	D26/86
D970,075 S	11/2022	Fogg et al.	

* cited by examiner

Primary Examiner — Mark A Goodwin

Assistant Examiner — William B Melliar

(74) *Attorney, Agent, or Firm* — Kunzler Bean & Adamson, PC; Michael Bartholomew

(57) **CLAIM**

The ornamental design for a vanity light fixture, as shown and described.

DESCRIPTION

FIG. 1 is a front, right and top perspective view of a vanity light fixture, showing my design.

FIG. 2 is a rear, left and bottom perspective view thereof.

FIG. 3 is a front elevation view thereof.

FIG. 4 is a rear elevation view thereof.

FIG. 5 is a left side elevation view thereof.

FIG. 6 is a right side elevation view thereof.

FIG. 7 is a top plan view thereof; and,

FIG. 8 is a bottom plan view thereof.

The broken lines depict portions of the vanity light fixture that form no part of the claimed design.

1 Claim, 8 Drawing Sheets

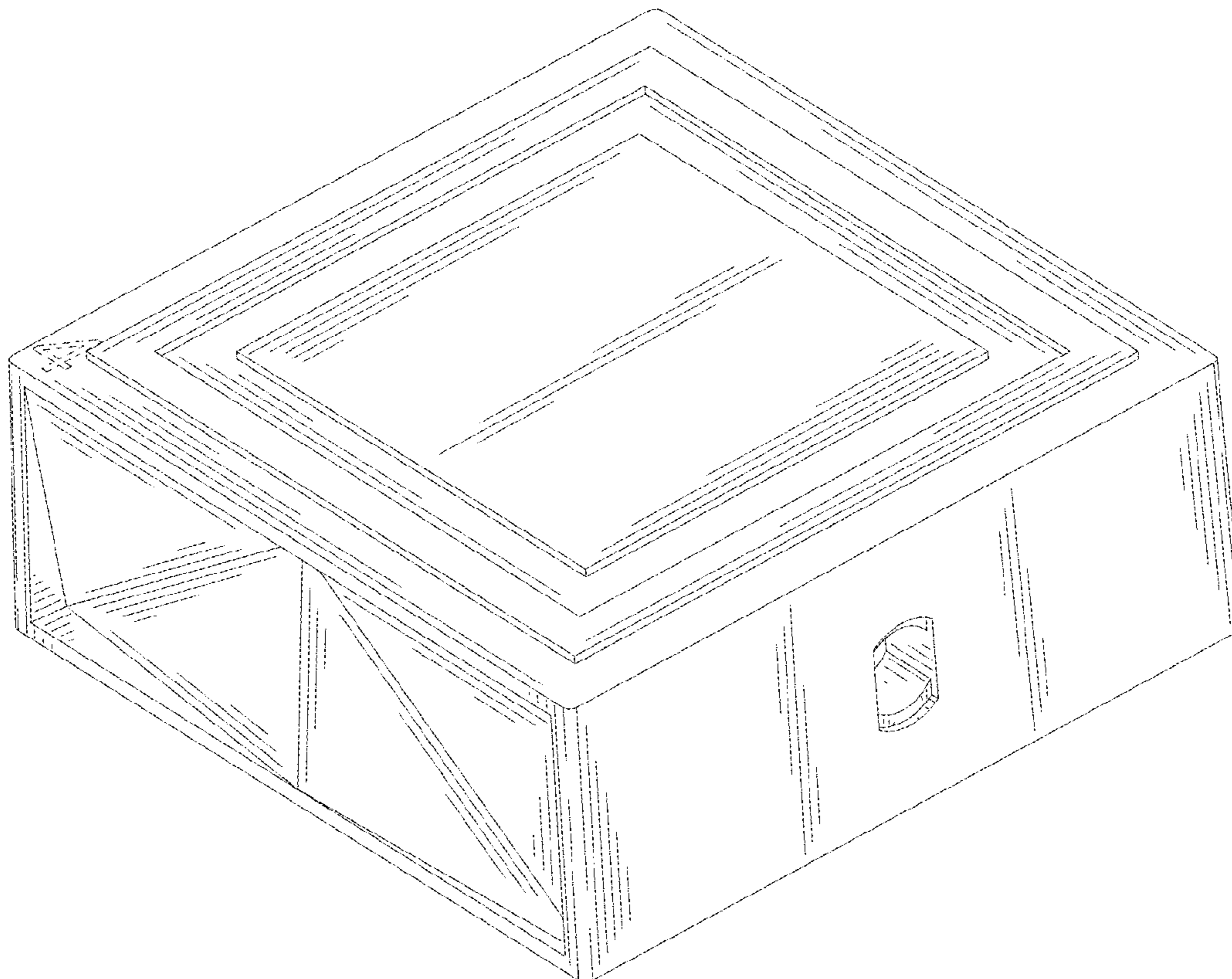

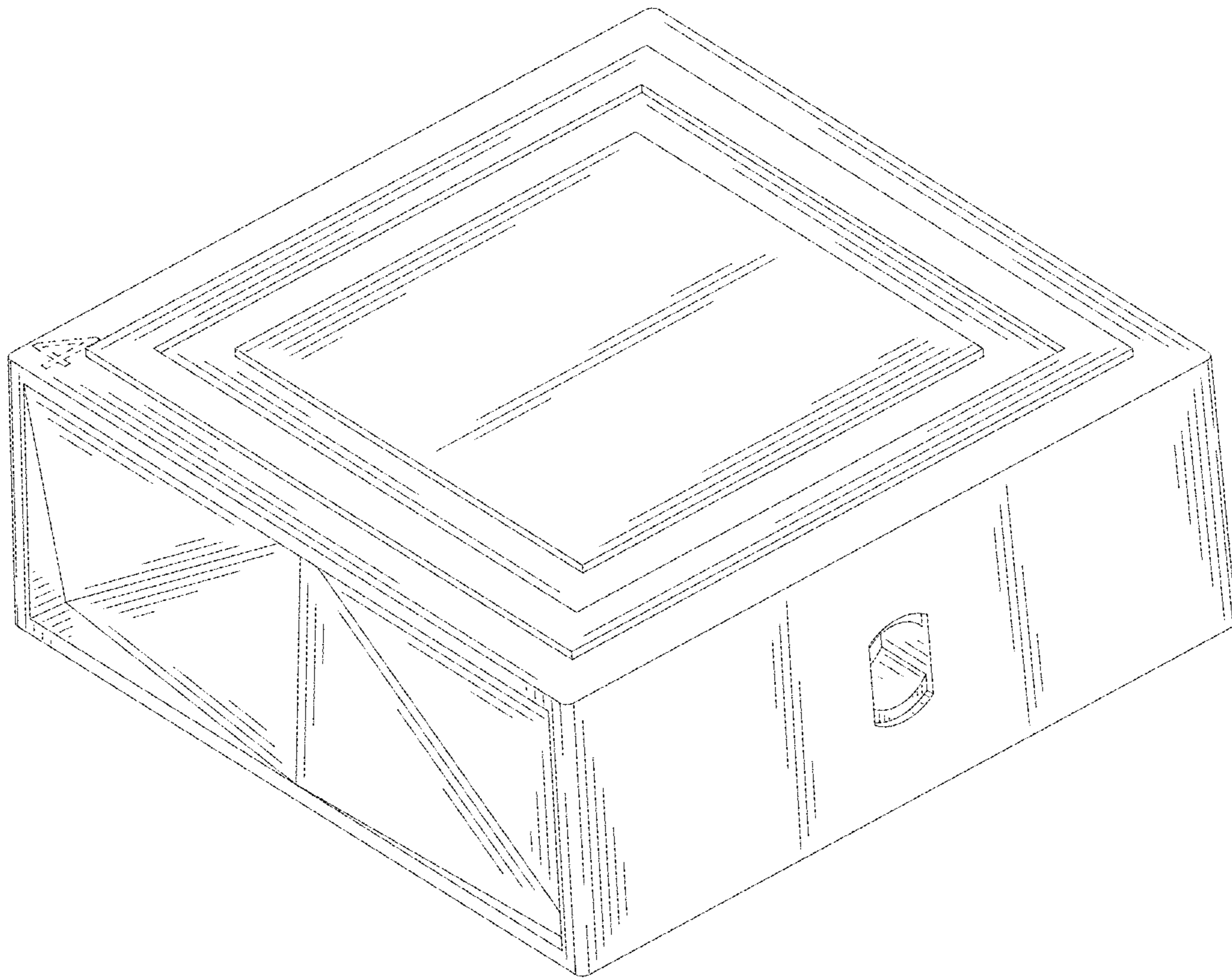

FIG. 1

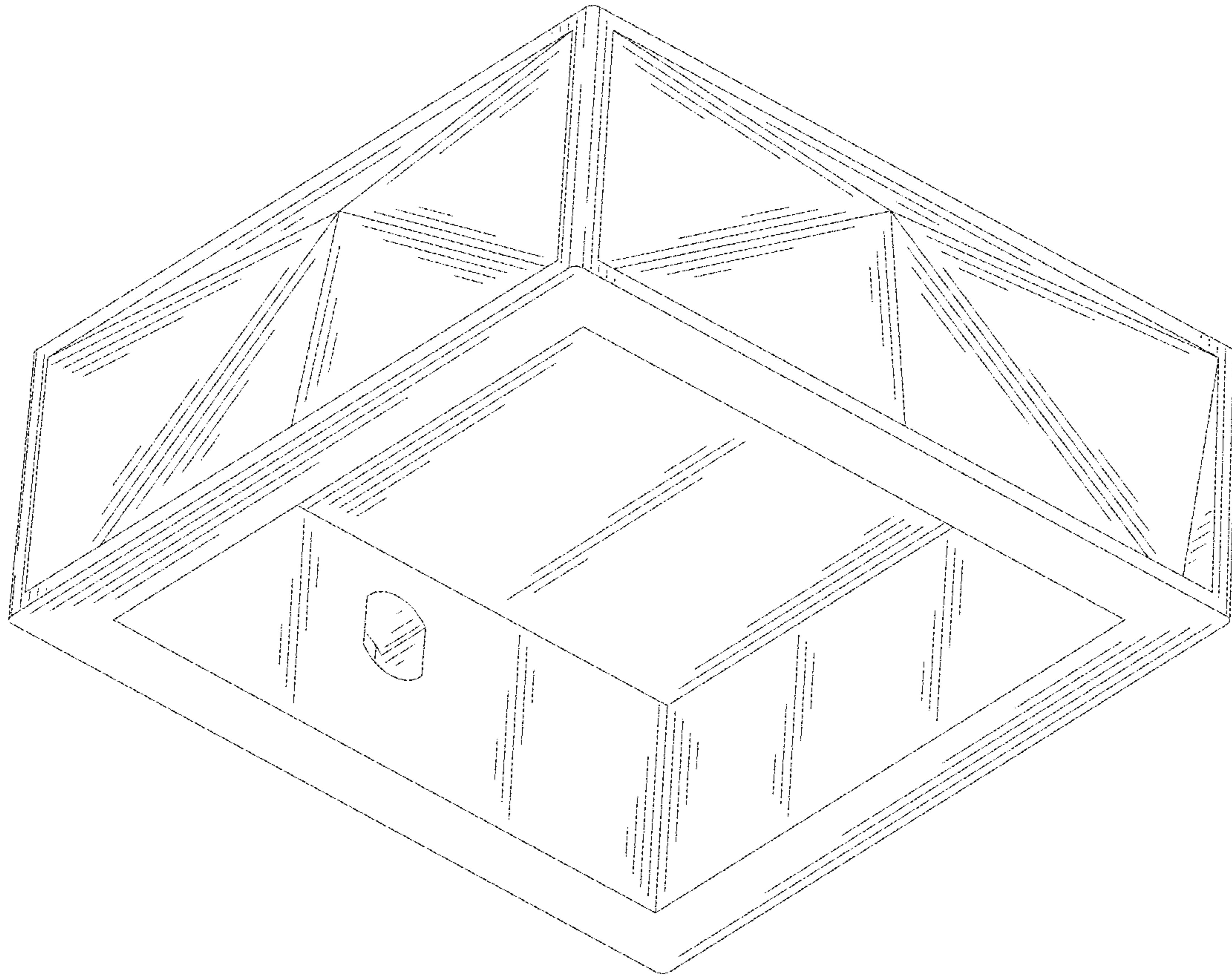

FIG. 2

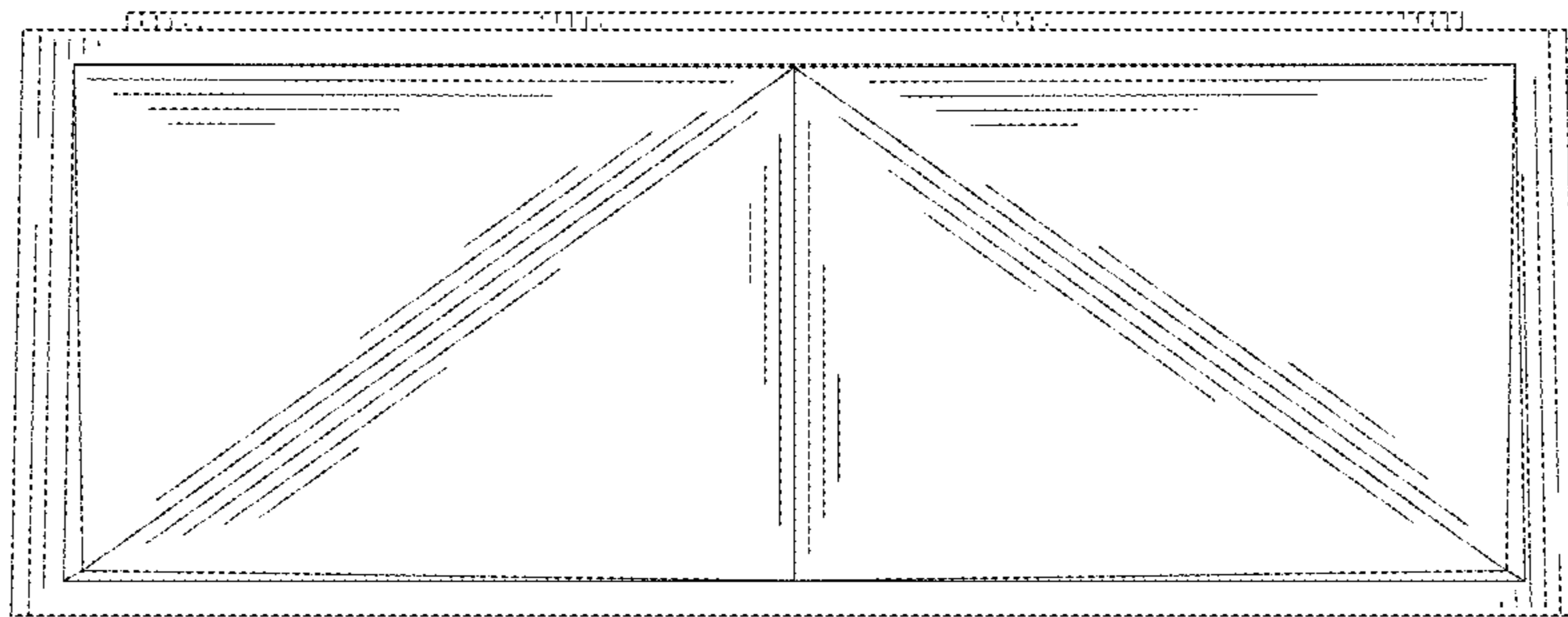

FIG. 3

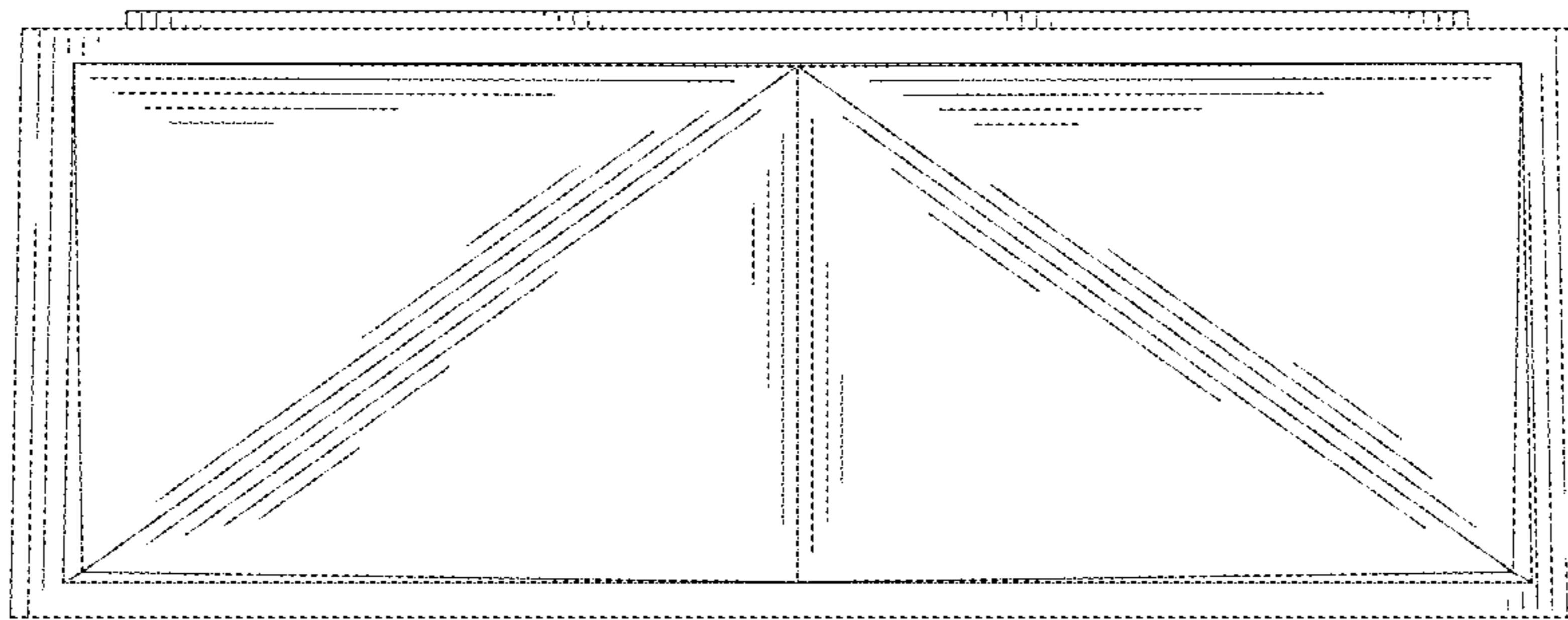

FIG. 4

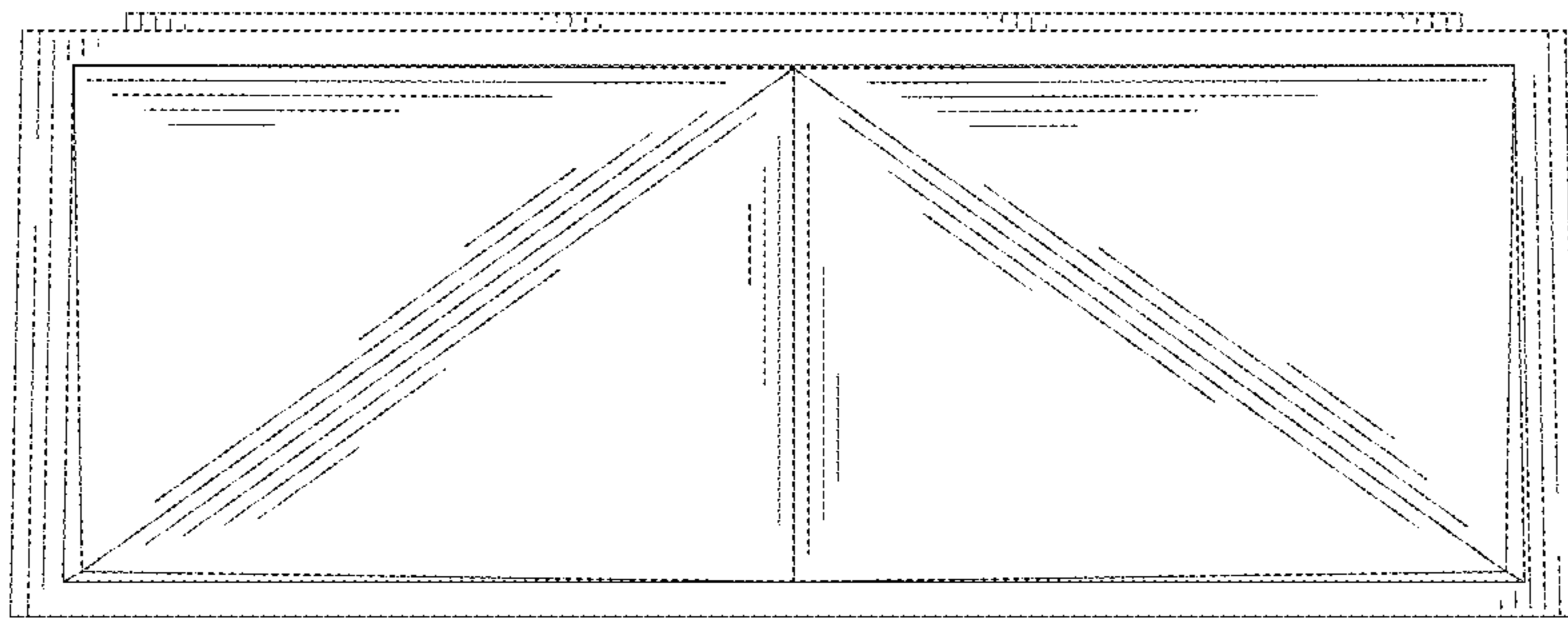

FIG. 5

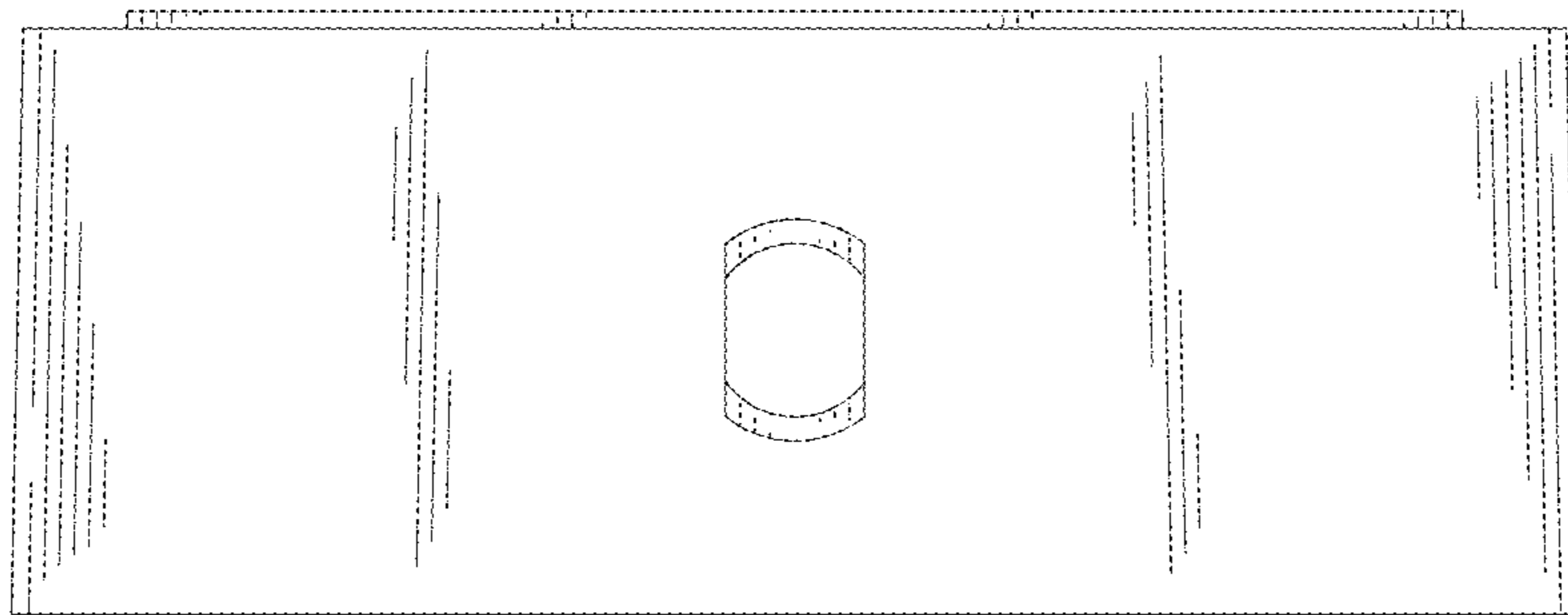

FIG. 6

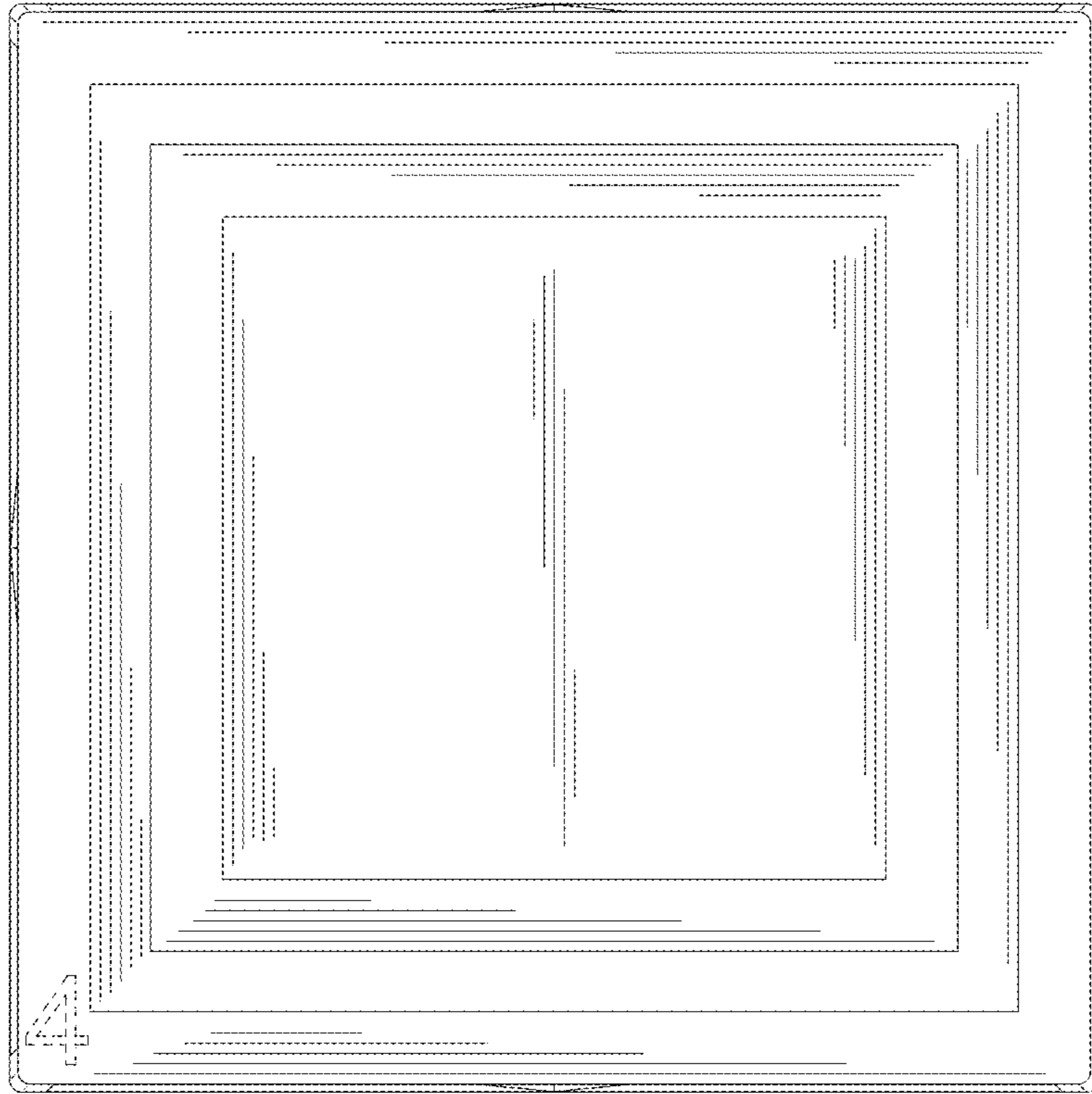

FIG. 7

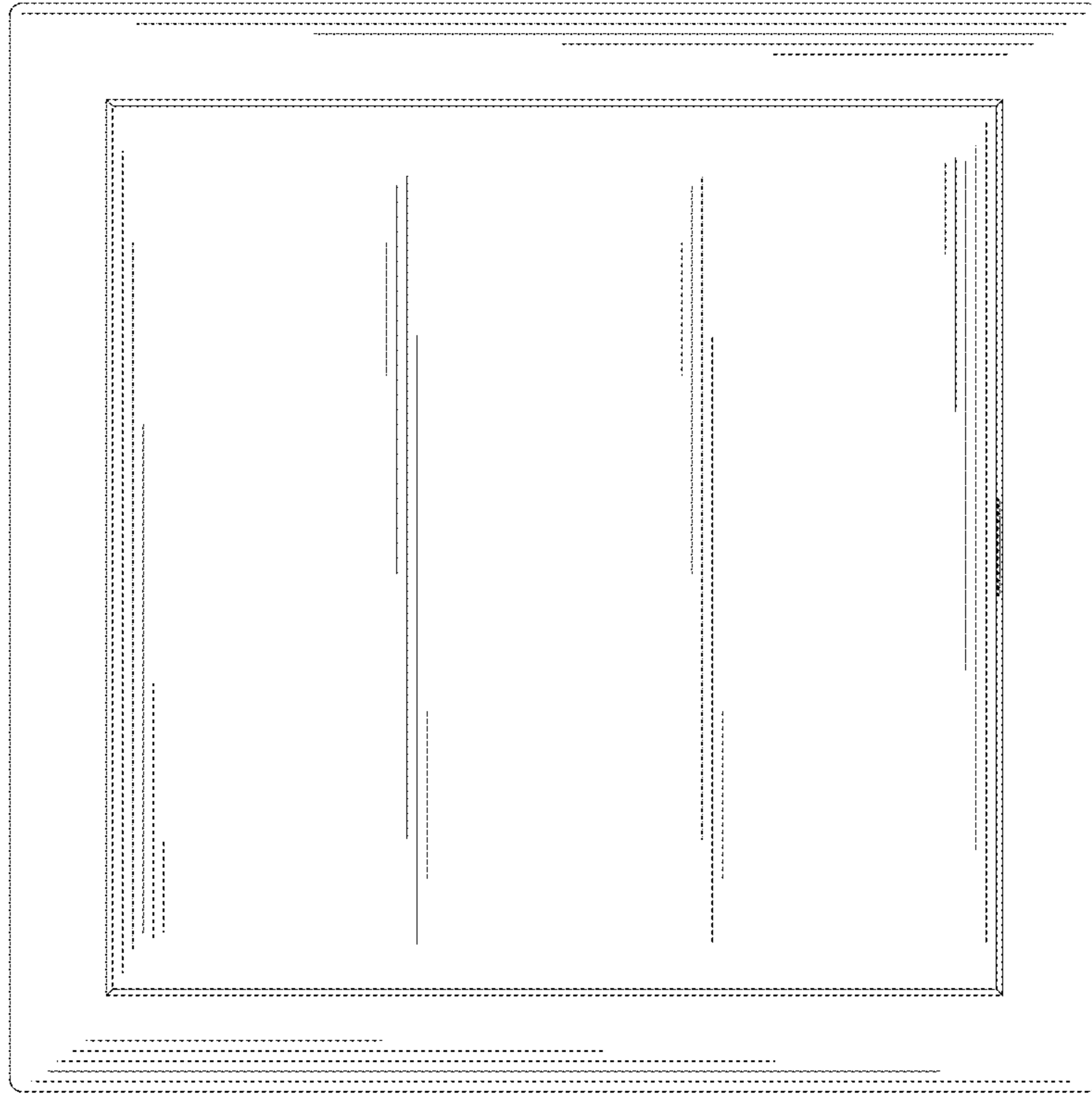

FIG. 8