



US00D984690S

(12) **United States Design Patent** (10) **Patent No.:** **US D984,690 S**  
**Zhou** (45) **Date of Patent:** **\*\* Apr. 25, 2023**

(54) **LAMP**

(71) Applicant: **Liuli Zhou**, Guangdong (CN)

(72) Inventor: **Liuli Zhou**, Guangdong (CN)

(\*\*) Term: **15 Years**

(21) Appl. No.: **29/862,139**

(22) Filed: **Dec. 6, 2022**

**Related U.S. Application Data**

(63) Continuation of application No. 29/840,787, filed on Jun. 1, 2022.

(51) **LOC (14) Cl.** ..... **26-04**

(52) **U.S. Cl.**  
USPC ..... **D26/25**

(58) **Field of Classification Search**  
USPC ..... D26/24, 25, 72, 73  
CPC ..... F21S 4/00; F21S 4/10; F21S 4/20; F21S 4/26

See application file for complete search history.

(56) **References Cited**

**U.S. PATENT DOCUMENTS**

D865,232 S	*	10/2019	Wu	.....	D26/25
D900,356 S	*	10/2020	Zhu	.....	D26/1
D952,198 S	*	5/2022	Qu	.....	D26/25
D962,493 S	*	8/2022	Xu	.....	D26/1
D962,499 S	*	8/2022	Zhu	.....	D26/25
D963,904 S	*	9/2022	Zhou	.....	D26/25
D966,140 S	*	10/2022	Wang	.....	D11/121
D966,574 S	*	10/2022	Zhou	.....	D26/25
D971,455 S		11/2022	Zhou		
D971,456 S		11/2022	Zhou		
D971,457 S	*	11/2022	Zhou	.....	D26/25

**FOREIGN PATENT DOCUMENTS**

EM 015005352-0002 \* 1/2023

**OTHER PUBLICATIONS**

“Toodour” reference by Toodour Direct on Amazon.com, date first available Jul. 2, 2022 [online], site visited Feb. 21, 2023, available from internet URL: <https://www.amazon.com/Toodour-LED-Christmas-Lights-Decorations/dp/B0B5N717W6?th=1> (Year: 2022).\*

“Zeroyoyo” reference on Amazon.com, date unavailable, site visited Feb. 21, 2023, available from internet URL: <https://www.amazon.com/ZEROYOYO-Christmas-Decorations-Decorative-Decoration/dp/BOBM5S61LB> (Year: 2023).\*

“LED Christmas” reference by DONWELL Shield on Amazon.com, date first available Nov. 28, 2022 [online], site visited Feb. 21, 2023, available from internet URL: <https://www.amazon.com/Christmas-Climbing-Ladder-Lights-Decorations/dp/BOBNHMCP2M> (Year: 2022).\*

\* cited by examiner

*Primary Examiner* — Richard Kearney

*Assistant Examiner* — Liv C Anderson

(74) *Attorney, Agent, or Firm* — ScienBiziP, P.C.

(57) **CLAIM**

The ornamental design for a lamp, as shown and described.

**DESCRIPTION**

FIG. 1 is a front, left and top perspective view of a lamp, showing my design.

FIG. 2 is a rear, left and bottom perspective view thereof.

FIG. 3 is a front elevation view thereof.

FIG. 4 is a rear elevation view thereof.

FIG. 5 is a left side elevation view thereof.

FIG. 6 is a right side elevation view thereof.

FIG. 7 is a top plan view thereof; and,

FIG. 8 is a bottom plan view thereof.

The broken lines depict portions of the lamp that form no part of the claimed design.

**1 Claim, 8 Drawing Sheets**

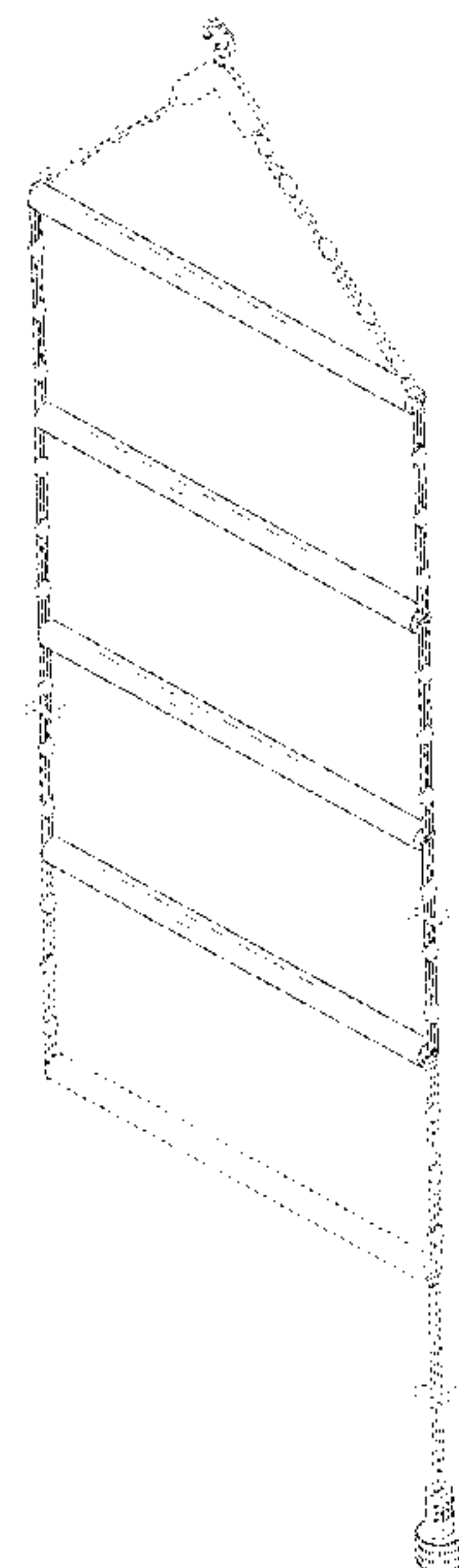

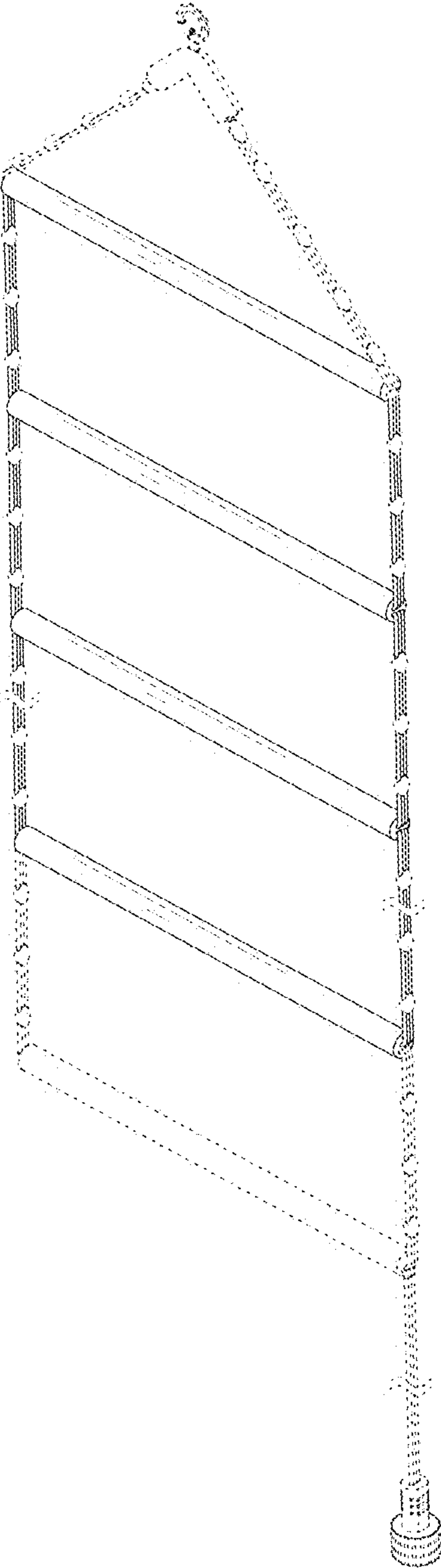

FIG.1

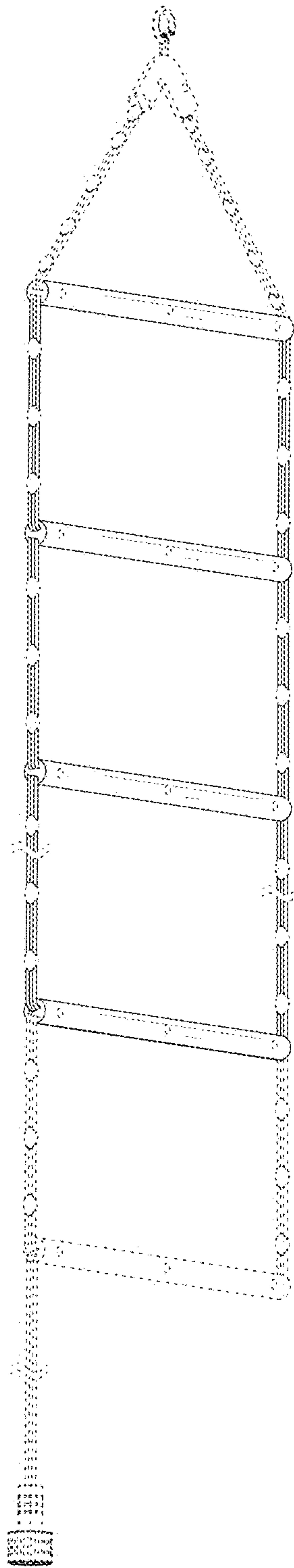

FIG.2

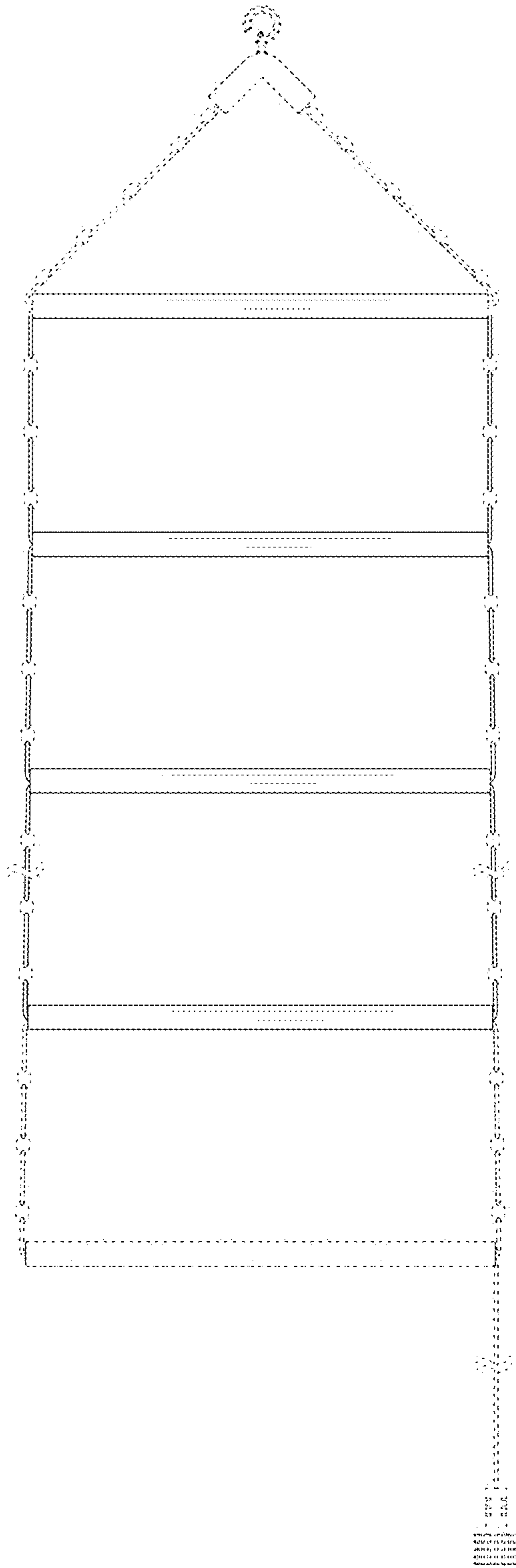

FIG.3

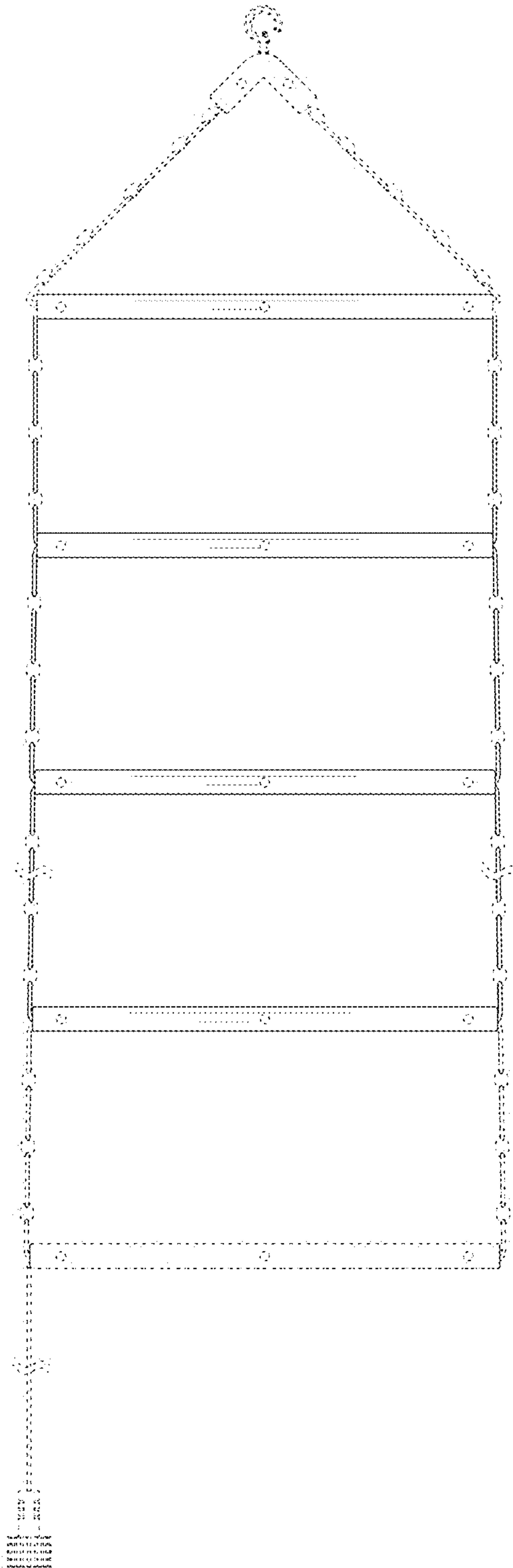

FIG.4

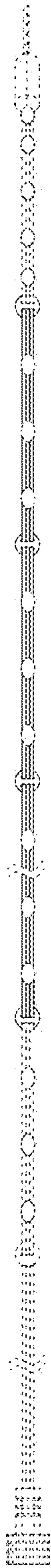

FIG. 5

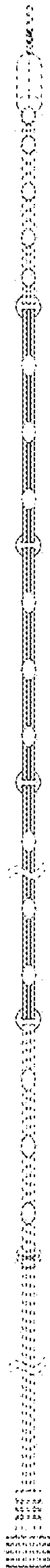

FIG.6

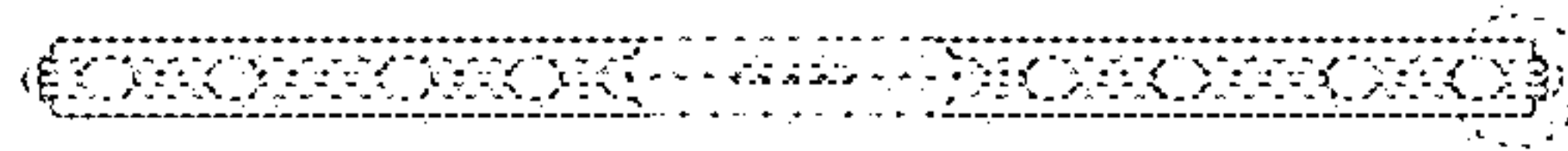

FIG.7



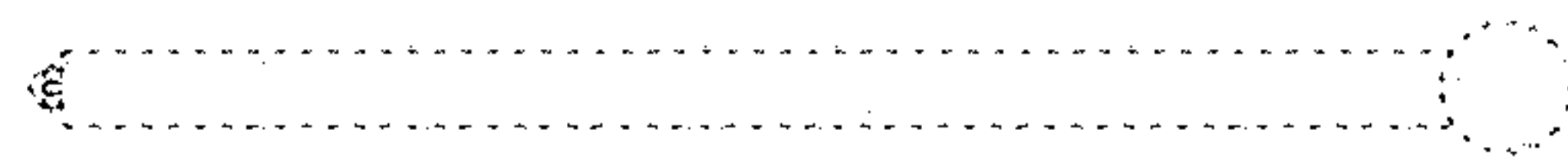

FIG.8