



US00D984632S

(12) **United States Design Patent** (10) **Patent No.:** **US D984,632 S**  
**Shan** (45) **Date of Patent:** **\*\* Apr. 25, 2023**

(54) **PORTABLE NEBULIZER** D928,935 S \* 8/2021 Li ..... D24/110  
D935,586 S \* 11/2021 Sun ..... D23/356  
(71) Applicant: **Shenzhen DaXianLaiTe Technology** D950,705 S \* 5/2022 Zhang ..... D24/110  
**Co., Ltd, Shenzhen (CN)** (Continued)

(72) Inventor: **Lihua Shan, Shenzhen (CN)**

(\*\*) Term: **15 Years**

(21) Appl. No.: **29/812,003**

(22) Filed: **Oct. 19, 2021**

(51) **LOC (14) Cl.** ..... **24-04**

(52) **U.S. Cl.**  
USPC ..... **D24/110**

(58) **Field of Classification Search**  
USPC ..... D24/110, 110.5, 107, 108, 164;  
D23/356, 359, 360, 366  
CPC ..... A61M 15/00; A61M 15/0021; A61M  
15/0026; A61M 15/0065; A61M 15/0085;  
A61M 15/0091; A61M 11/00; A61M  
11/002; A61M 11/003; A61M 11/005;  
A61M 11/006; A61M 11/007; A61M  
11/008; A61M 11/02; A61J 19/00; A61J  
19/02

See application file for complete search history.

(56) **References Cited**

**U.S. PATENT DOCUMENTS**

D704,825 S 5/2014 Flickinger  
D753,282 S \* 4/2016 Lee ..... D24/100  
D827,809 S 9/2018 Mitchell  
D837,365 S \* 1/2019 Li ..... D24/110  
D884,876 S 5/2020 Jung  
D886,278 S 6/2020 Lin  
D888,932 S 6/2020 Jung  
D888,933 S 6/2020 Jung  
D889,635 S 7/2020 Mitchell  
D900,303 S 10/2020 Mitchell  
D900,304 S 10/2020 Xia  
D905,846 S \* 12/2020 Mitchell ..... D24/110  
D928,934 S 8/2021 Lin

**FOREIGN PATENT DOCUMENTS**

CN 302950296 \* 9/2014  
CN 302950297 \* 9/2014  
(Continued)

**OTHER PUBLICATIONS**

Portable Nebulizer—Handheld Mesh Nebulizer Machine for Adults & Kids and Household Use by APOWUS. Amazon. Date first available: Feb. 14, 2021; Retrieval date: Sep. 15, 2022. Retrieved from internet: <https://www.amazon.com/Portable-Nebulizer-Handheld-Household-Breathing/dp/B08WL9XGB2> (Year: 2021).\*

*Primary Examiner* — Daniel J Domino  
*Assistant Examiner* — Lee D. Starr  
(74) *Attorney, Agent, or Firm* — Rumit Ranjit Kanakia

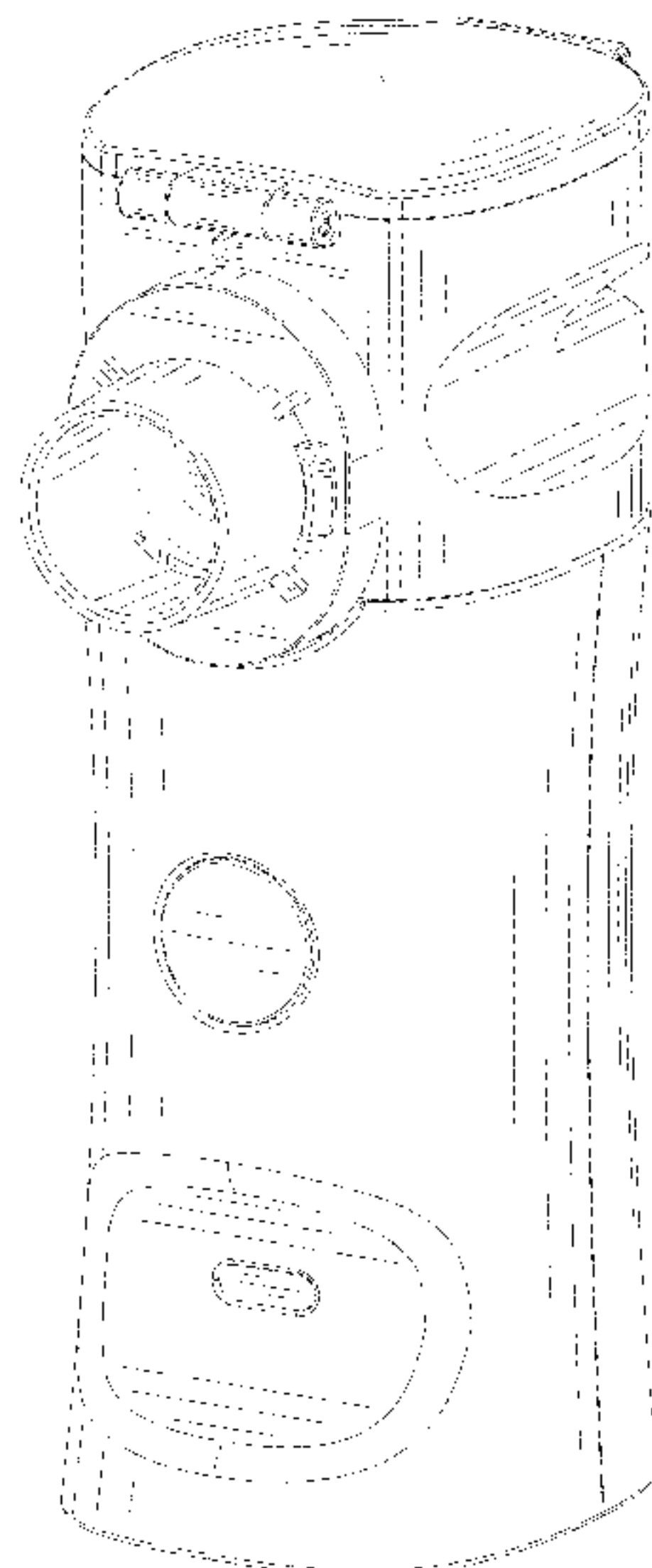
(57) **CLAIM**

The ornamental design for a portable nebulizer, as shown and described.

**DESCRIPTION**

FIG. 1 is a perspective view of a portable nebulizer showing my new design;  
FIG. 2 is another perspective view thereof;  
FIG. 3 is a front elevational view;  
FIG. 4 is a rear elevational view thereof;  
FIG. 5 is a left side view thereof;  
FIG. 6 is a right side view thereof;  
FIG. 7 is a top plan view thereof; and,  
FIG. 8 is a bottom plan view thereof.  
The broken lines in the figures are for the purposes of illustrating portions of the portable nebulizer, which form no part of the claimed design.

**1 Claim, 8 Drawing Sheets**



(56)

**References Cited**

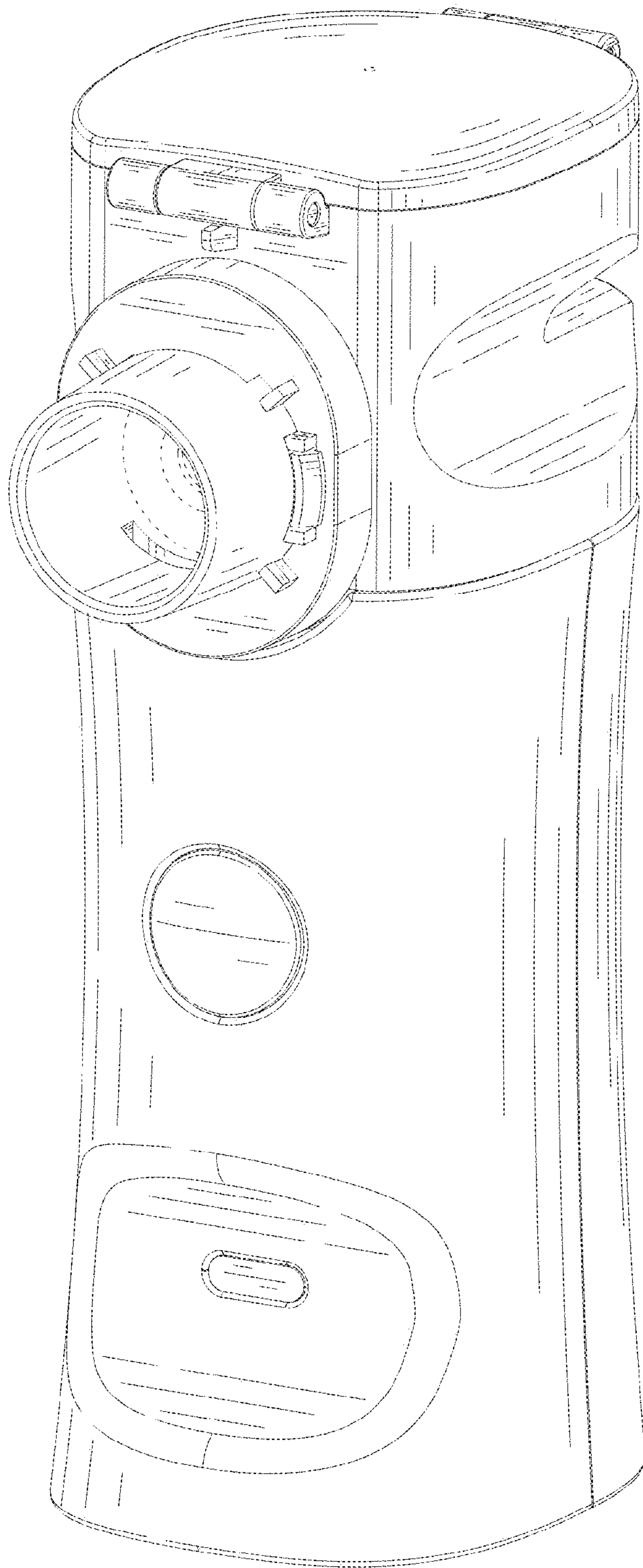
U.S. PATENT DOCUMENTS

D953,518	S	*	5/2022	Xia	.....	D24/110
D954,924	S	*	6/2022	Sun	.....	D23/360
D954,934	S	*	6/2022	Mitchell	.....	D24/110
D954,935	S	*	6/2022	Mitchell	.....	D24/110
D972,714	S	*	12/2022	Chang	.....	D24/110
2009/0114737	A1	*	5/2009	Yu	.....	B05B 12/081 239/69
2019/0231991	A1	*	8/2019	Tsai	.....	A61M 11/002
2019/0231995	A1	*	8/2019	Tsai	.....	A61M 15/0065
2020/0185077	A1	*	6/2020	Huang	.....	A61M 15/00
2022/0249785	A1	*	8/2022	Chang	.....	A61M 15/0065

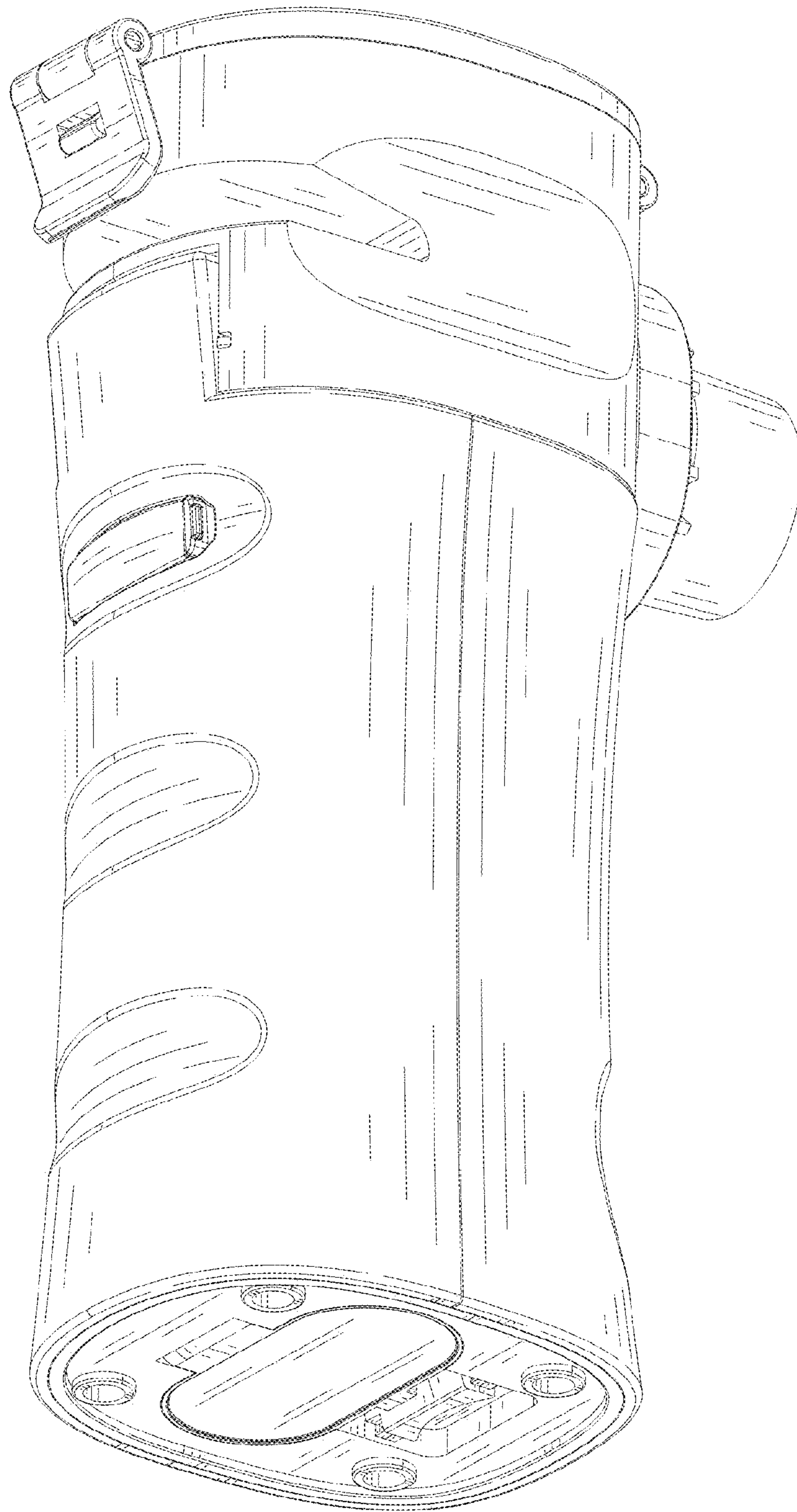
FOREIGN PATENT DOCUMENTS

CN	305116235	*	4/2019
EM	005535523-0004	*	10/2018
EM	007383815-0003	*	12/2019
EM	007872320-0056	*	5/2020
EM	007872320-0059	*	5/2020
EM	007770920-0009	*	6/2020
EM	007770920-0013	*	6/2020
EM	008813893-0001	*	1/2022
EM	008914410-0002	*	3/2022
GB	9008169346-0006	*	9/2020
GB	6131696	*	4/2021
GB	6131697	*	4/2021

\* cited by examiner

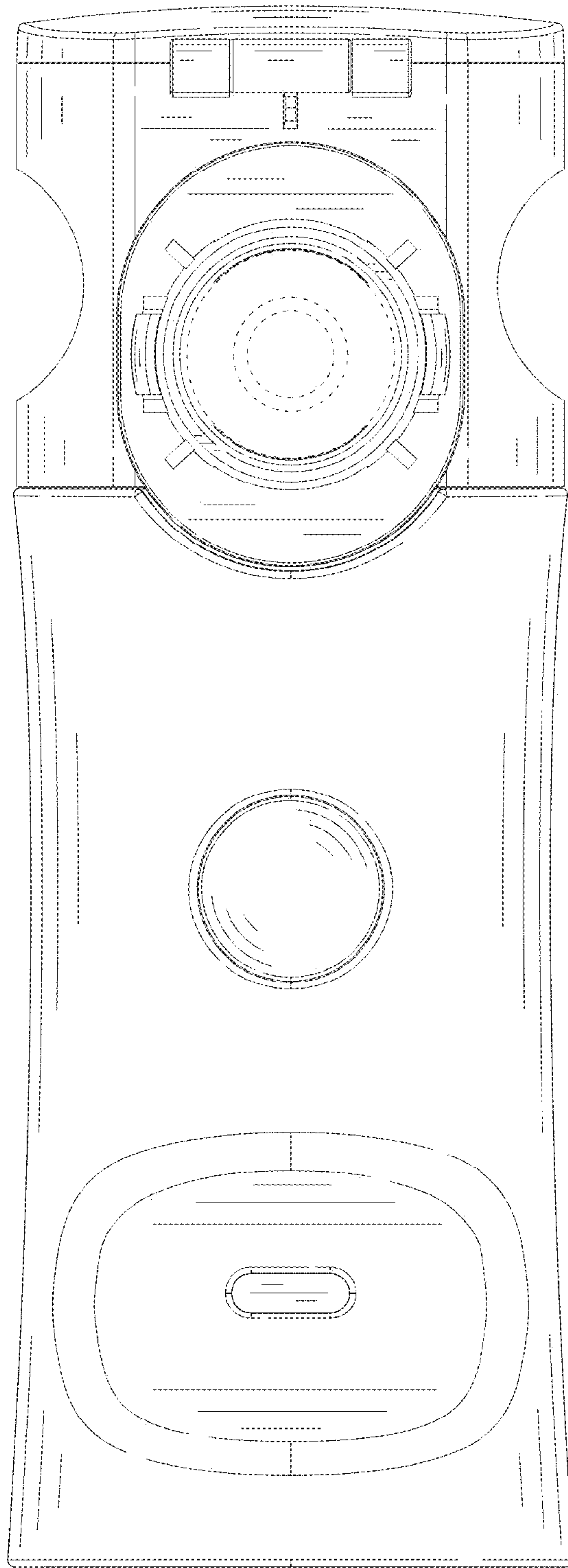


**FIG. 1**

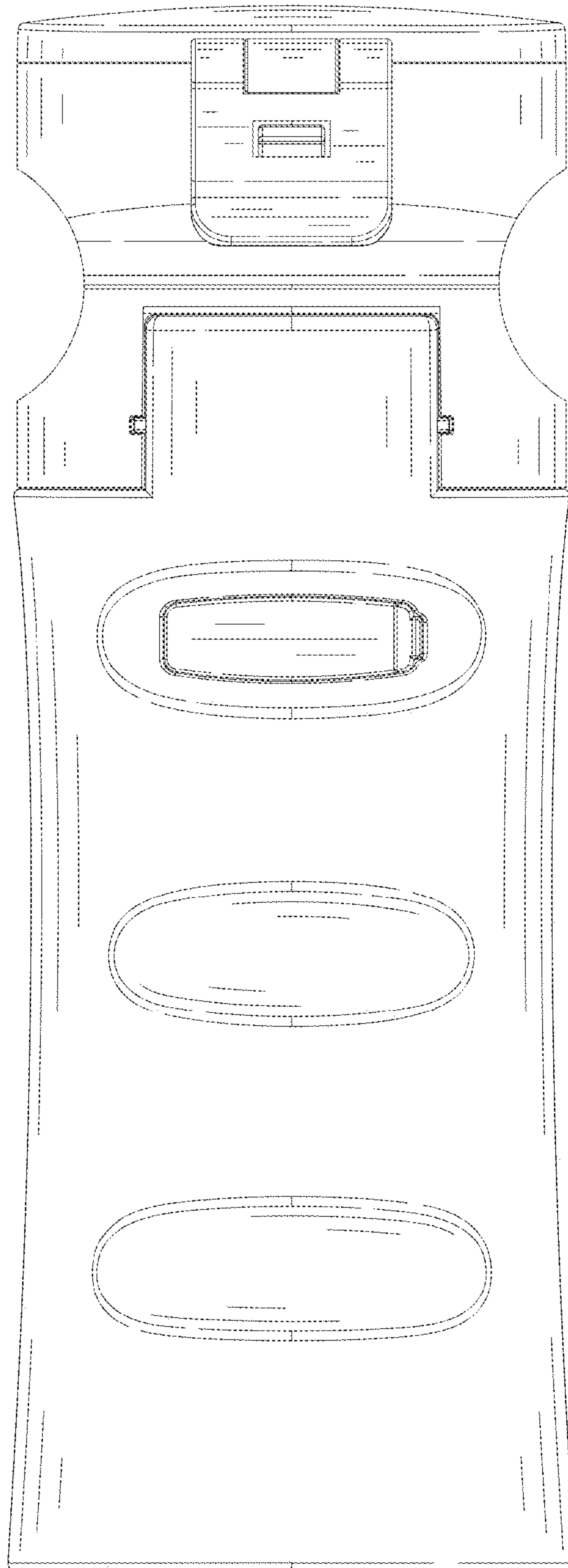


**FIG. 2**

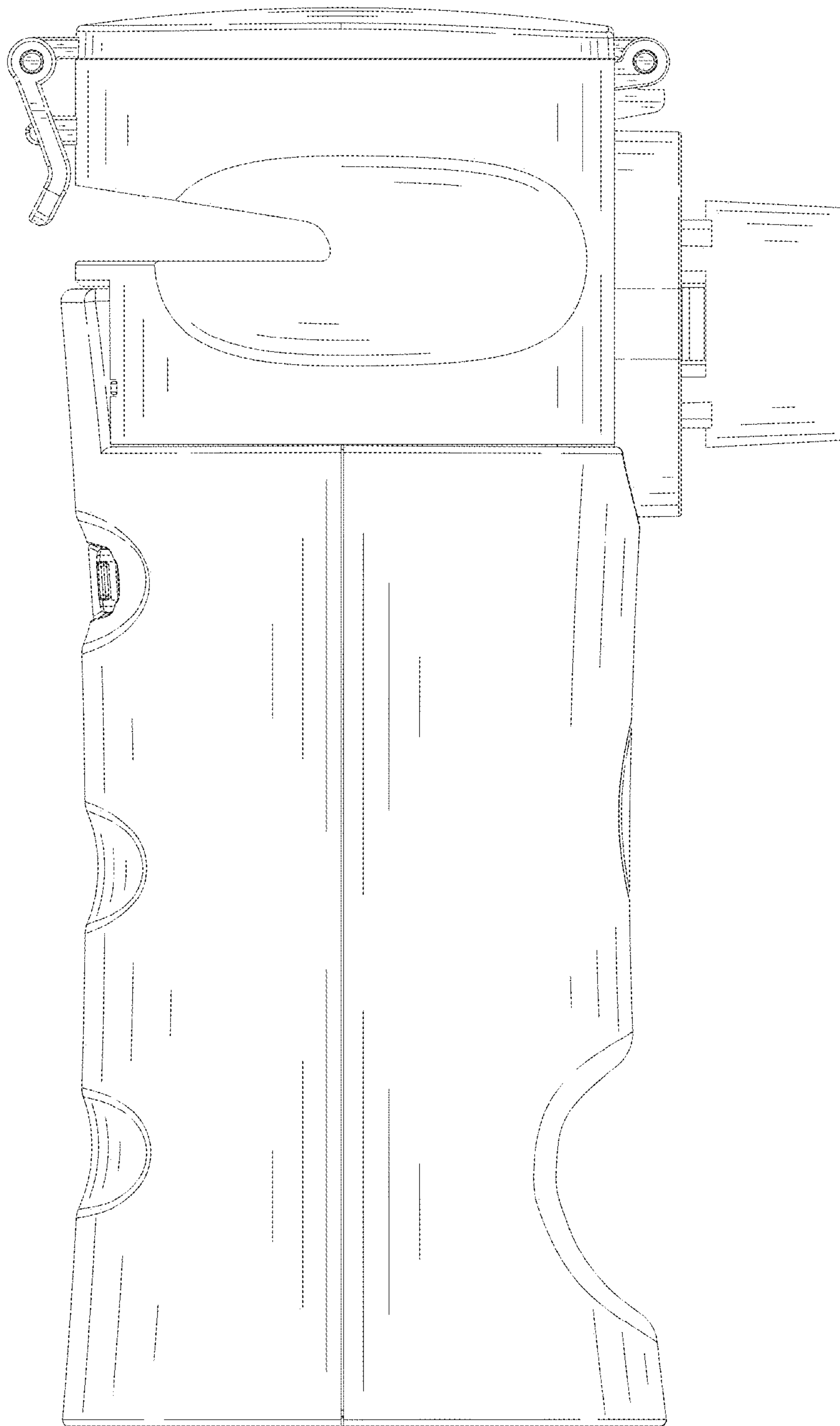




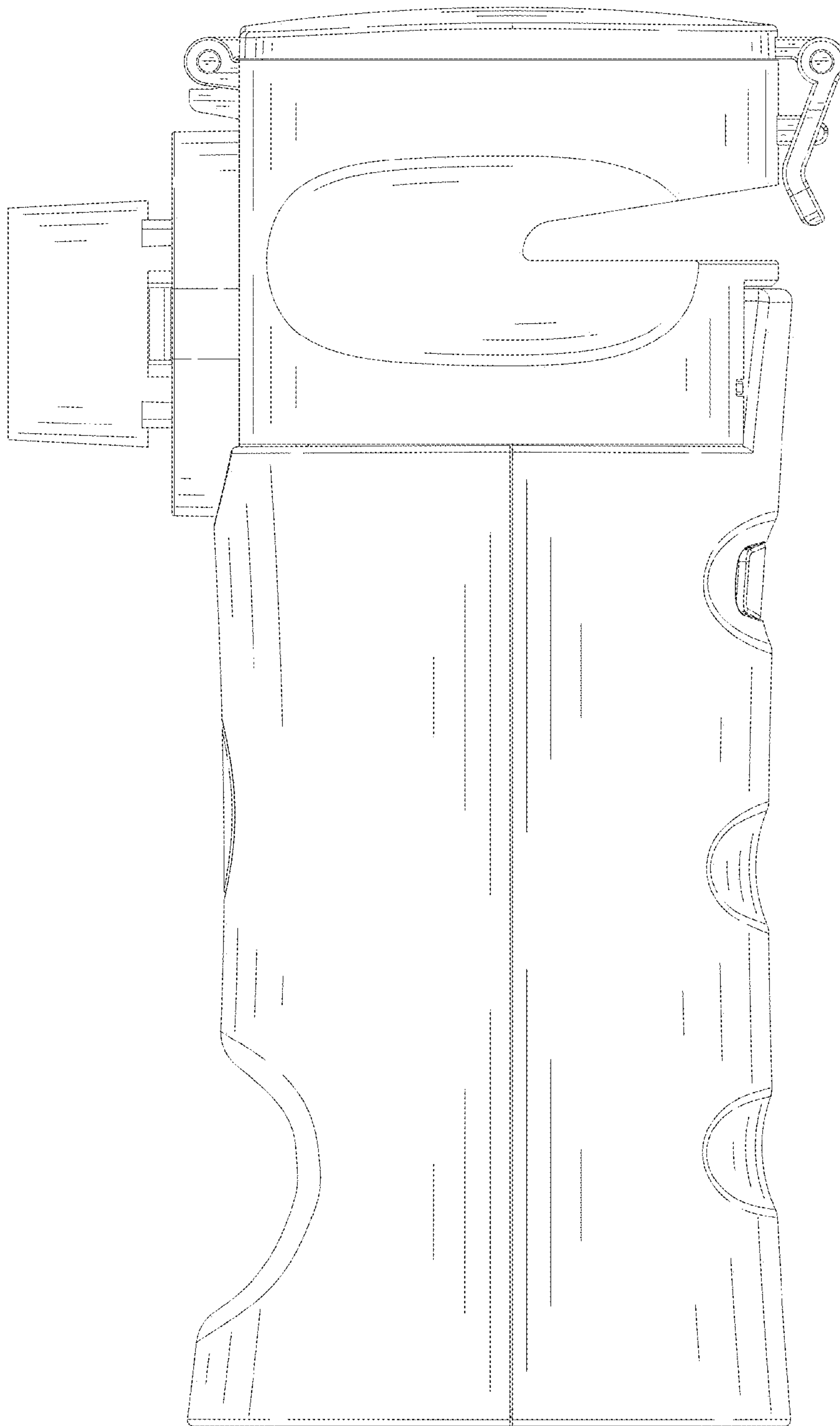
**FIG. 3**



**FIG. 4**

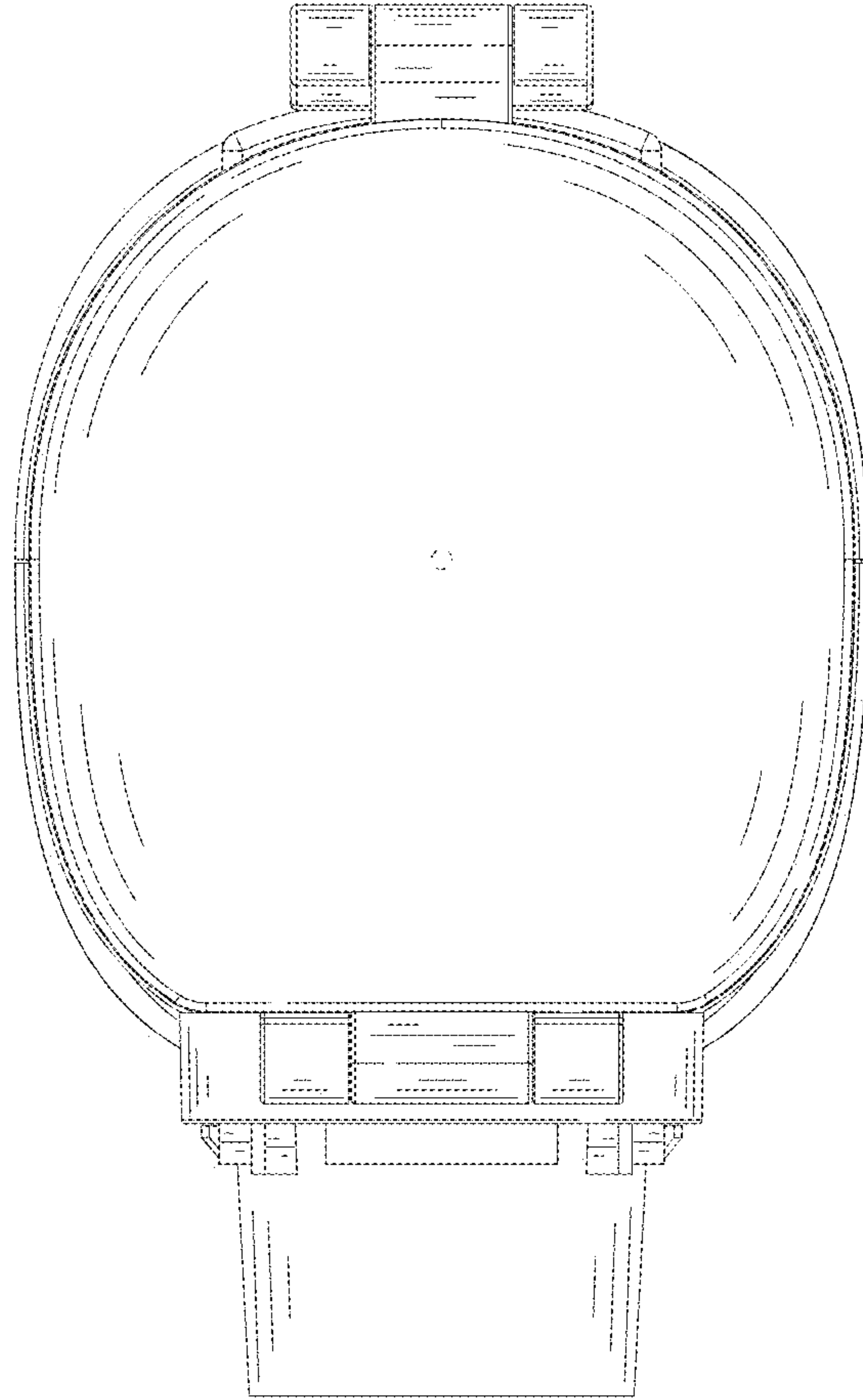


**FIG. 5**

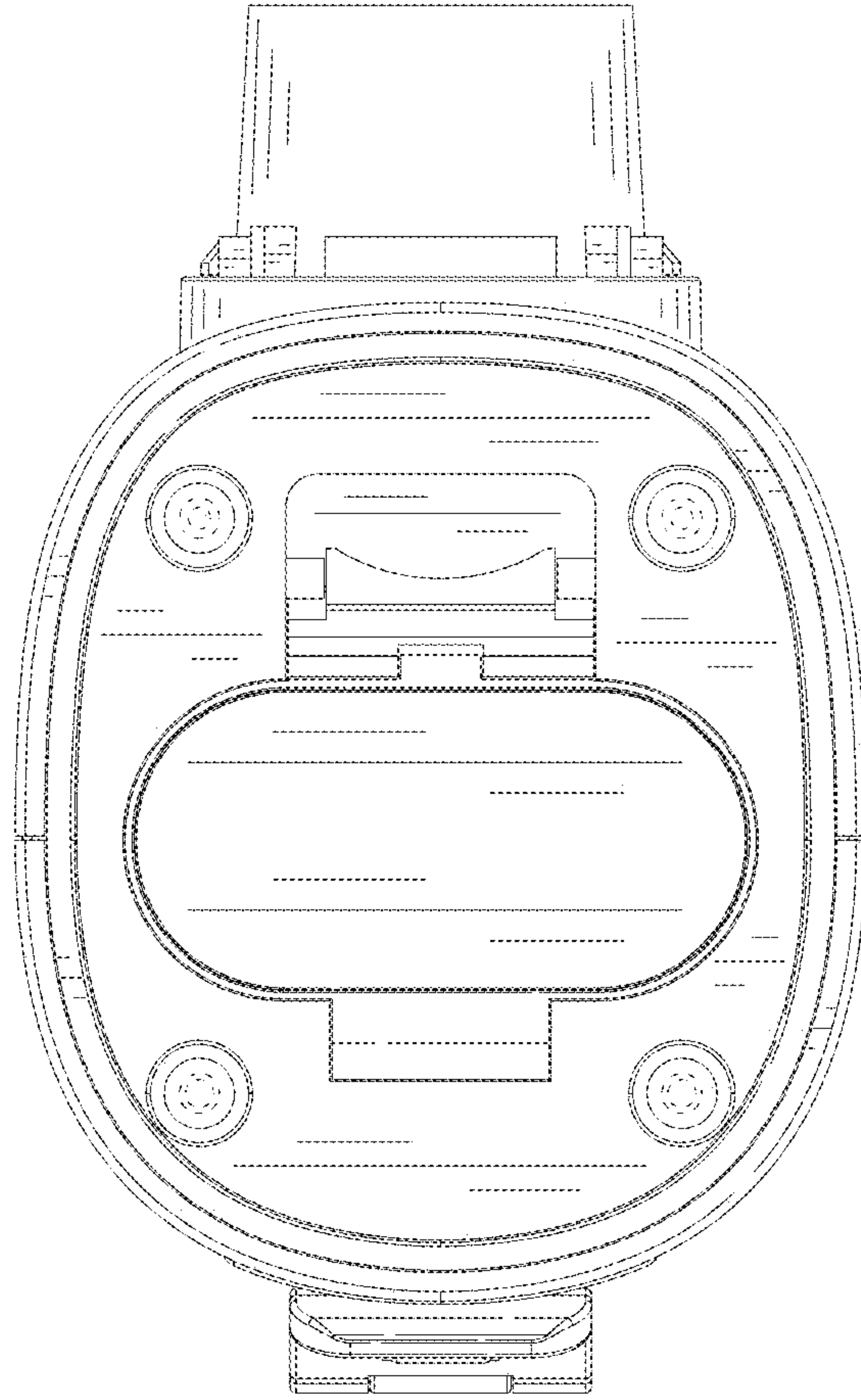


**FIG. 6**





**FIG. 7**



**FIG. 8**