



US00D984573S

(12) **United States Design Patent** (10) **Patent No.:** **US D984,573 S**
Ieong (45) **Date of Patent:** **** Apr. 25, 2023**

(54) **INFLATABLE SWIMMING RING**

FOREIGN PATENT DOCUMENTS

(71) Applicant: **SZDY TOYS (HK) CO., LIMITED**,
Kowloon (HK)

CN 307404832 * 6/2022
HK 2017035-0001 * 2/2021
JP D1693564 * 8/2021

(72) Inventor: **Tou Peng Ieong**, Kowloon (HK)

OTHER PUBLICATIONS

(73) Assignee: **SZDY TOYS (HK) CO., LIMITED**,
Kowloon (HK)

Amazon Website, Laycol Baby Swimming Float, Earliest available date: May 27, 2020, [Website Visited on Jul. 21, 2022], Available on the internet URL <https://www.amazon.com/LAYCOL-Swimming-Inflatable-Newest-Protection/dp/B083VZ64GV/> (Year: 2020).
Amazon Website, Free Swimming Baby Inflatable, Earliest review date: Nov. 3, 2017, [Website Visited on Jul. 21, 2022], Available on the internet URL <https://www.amazon.com/Free-Swimming-Baby-Inflatable-Accessories/dp/B072N2J366/> (Year: 2017).
Amazon Website, Laycol Baby Swimming Float, Earliest review date: Mar. 5, 2020, [Website Visited on Jul. 21, 2022], Available on the internet URL <https://www.amazon.com/LAYCOL-Swimming-Inflatable-Newest-Protection/dp/B091SQ82NS/> (Year: 2020).*

(**) Term: **15 Years**

(21) Appl. No.: **29/754,157**

(22) Filed: **Oct. 7, 2020**

(51) **LOC (14) Cl.** **29-02**

(52) **U.S. Cl.**

USPC **D21/804; D21/808; D21/809**

(58) **Field of Classification Search**

USPC D21/809, 808, 803, 804; D30/160;
D12/5, 316; D6/597

CPC B63C 9/065; B63C 9/155; A63B 35/06;
A63B 41/125

See application file for complete search history.

* cited by examiner

Primary Examiner — S. Bryan Reinholdt, Jr.

Assistant Examiner — James T. Tyree

(74) *Attorney, Agent, or Firm* — WPAT, PC

(57)

CLAIM

The ornamental design for an inflatable swimming ring, as shown and described.

DESCRIPTION

FIG. 1 is a perspective view of an inflatable swimming ring showing my new design;

FIG. 2 is a front view thereof;

FIG. 3 is a rear view thereof;

FIG. 4 is a left side view thereof;

FIG. 5 is a right side view thereof;

FIG. 6 is a top view thereof; and,

FIG. 7 is a bottom view thereof.

The broken lines depict portions of the inflatable swimming ring that form no part of the claimed design.

(56) **References Cited**

U.S. PATENT DOCUMENTS

1,465,790 A * 8/1923 Ranlett A47C 15/006
D21/803
D203,363 S * 12/1965 Crawford D21/805
D330,139 S * 10/1992 Bloom 5/655
D367,910 S * 3/1996 Roberts D21/804
D393,680 S * 4/1998 Peterson D21/809
D393,681 S * 4/1998 Peterson D21/809
D891,557 S * 7/2020 He D21/808
2020/0164952 A1 * 5/2020 Zhou B63C 9/115

1 Claim, 7 Drawing Sheets

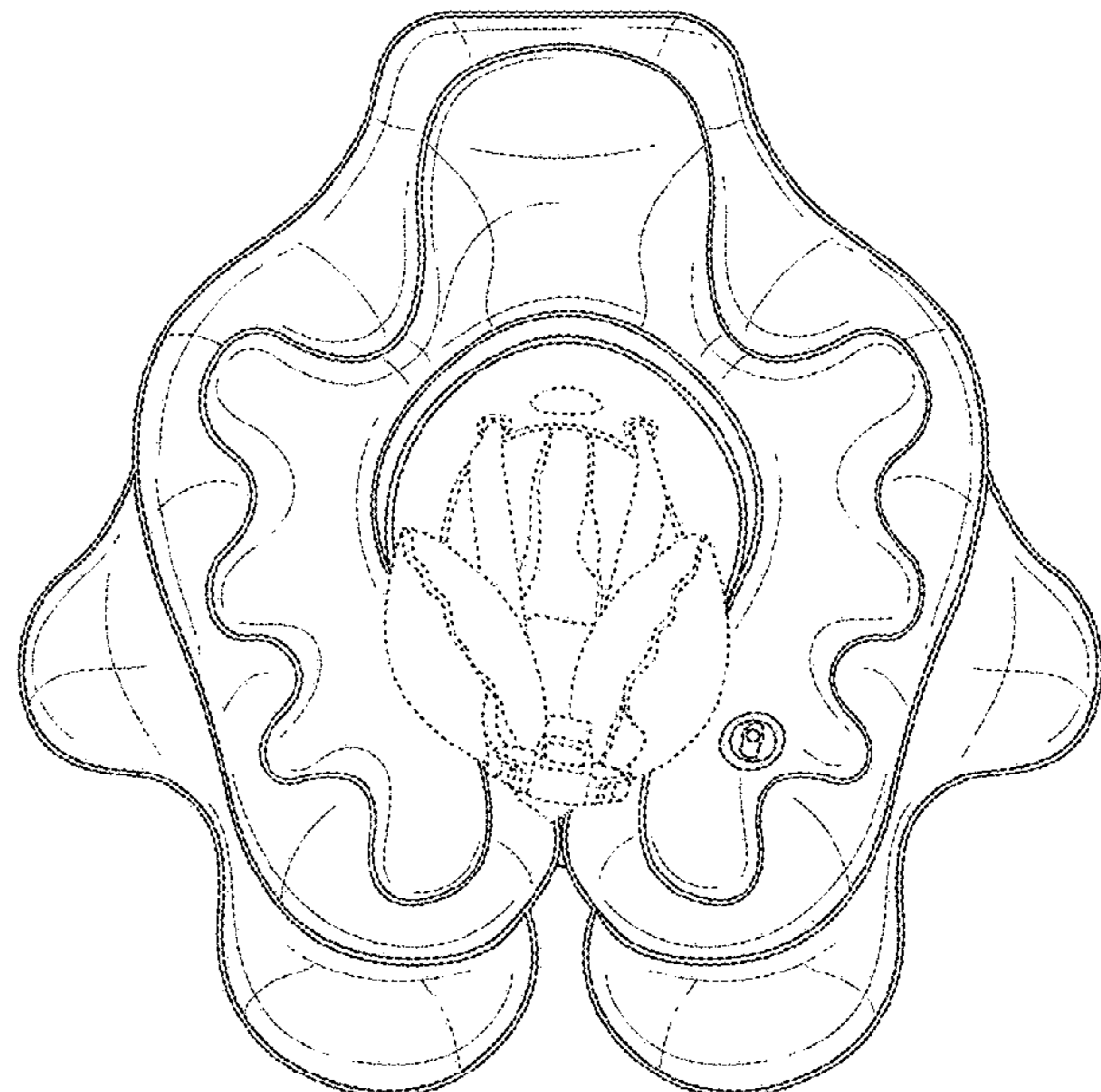

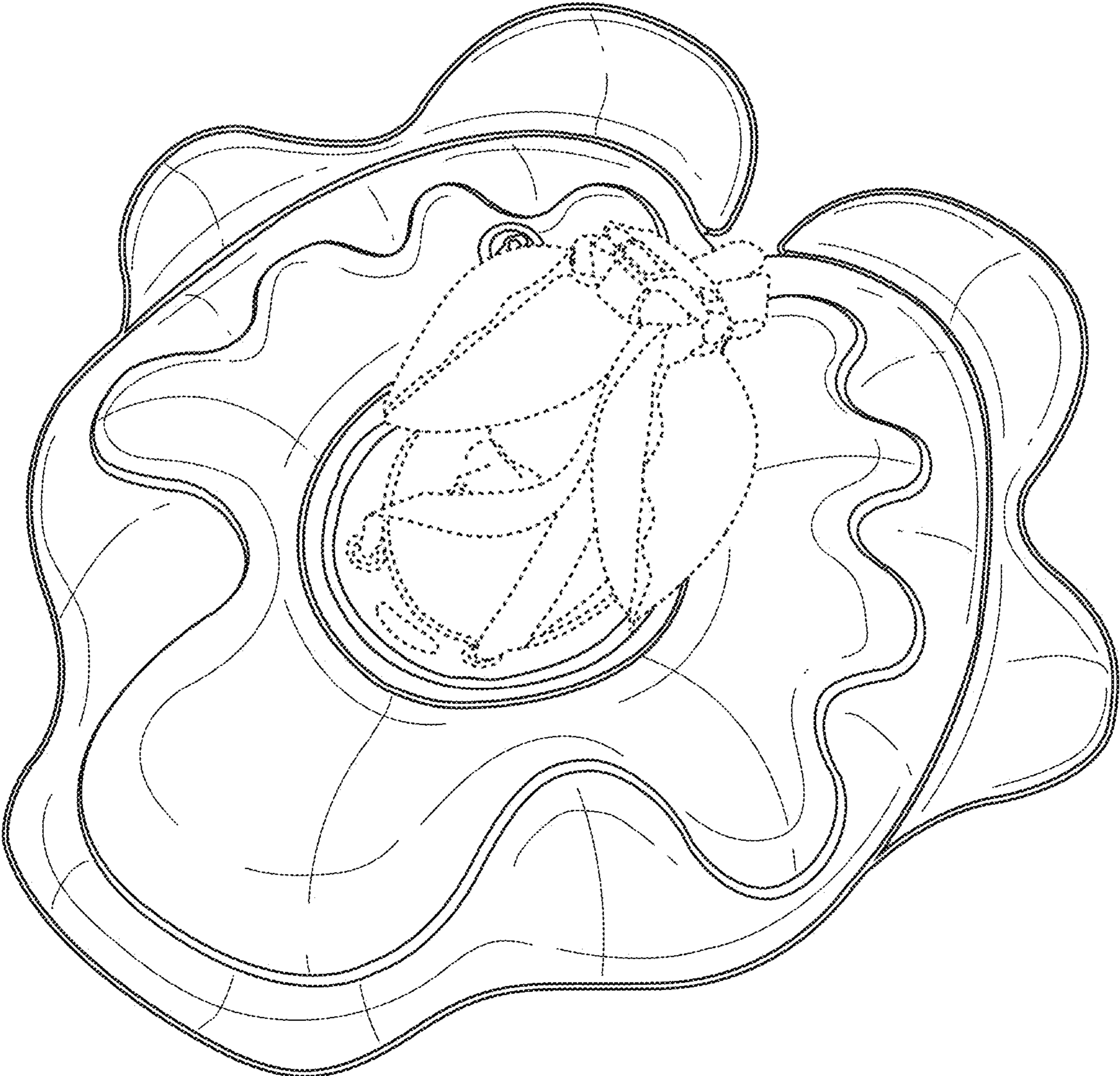

Fig. 1

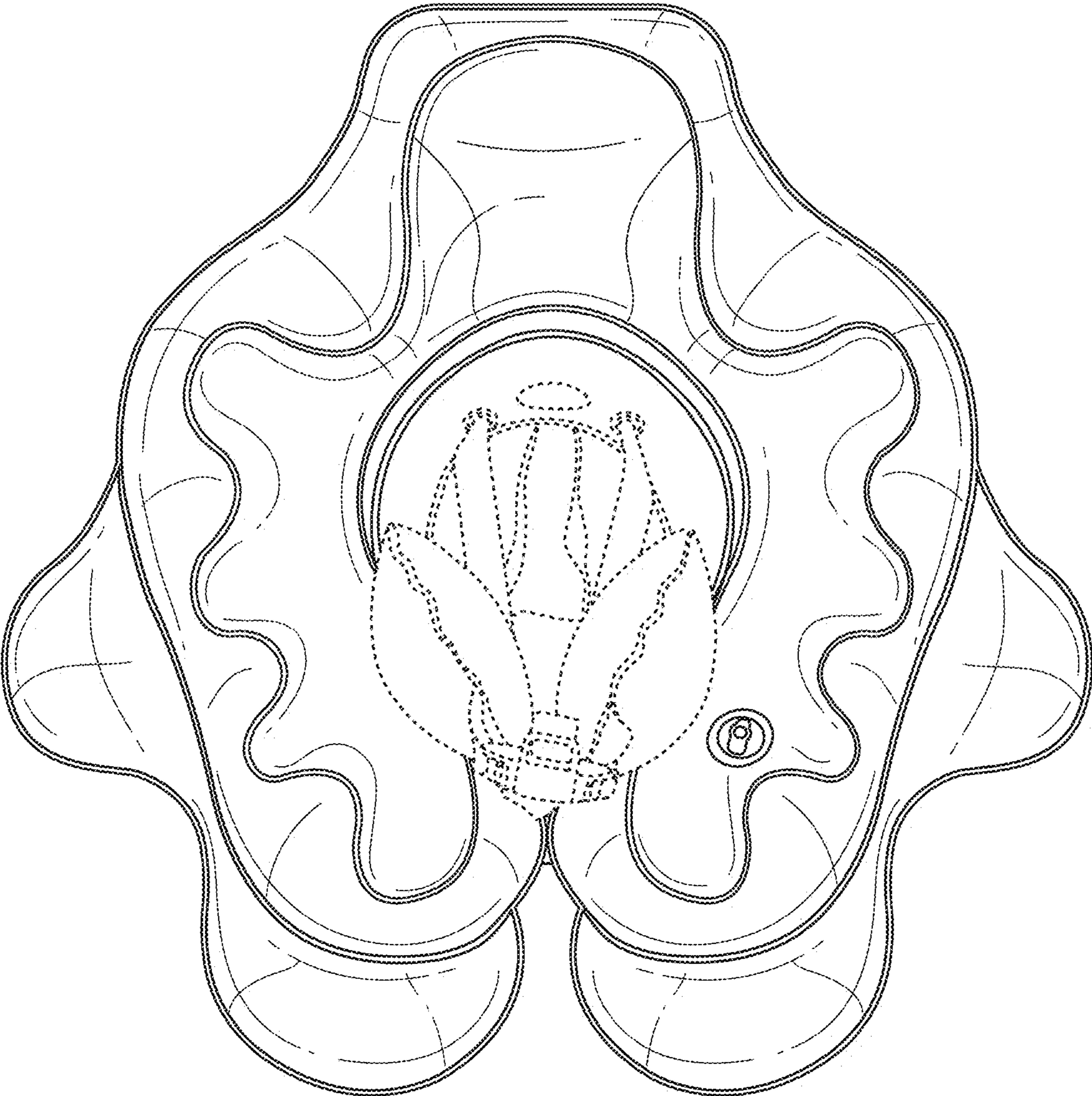

Fig. 2

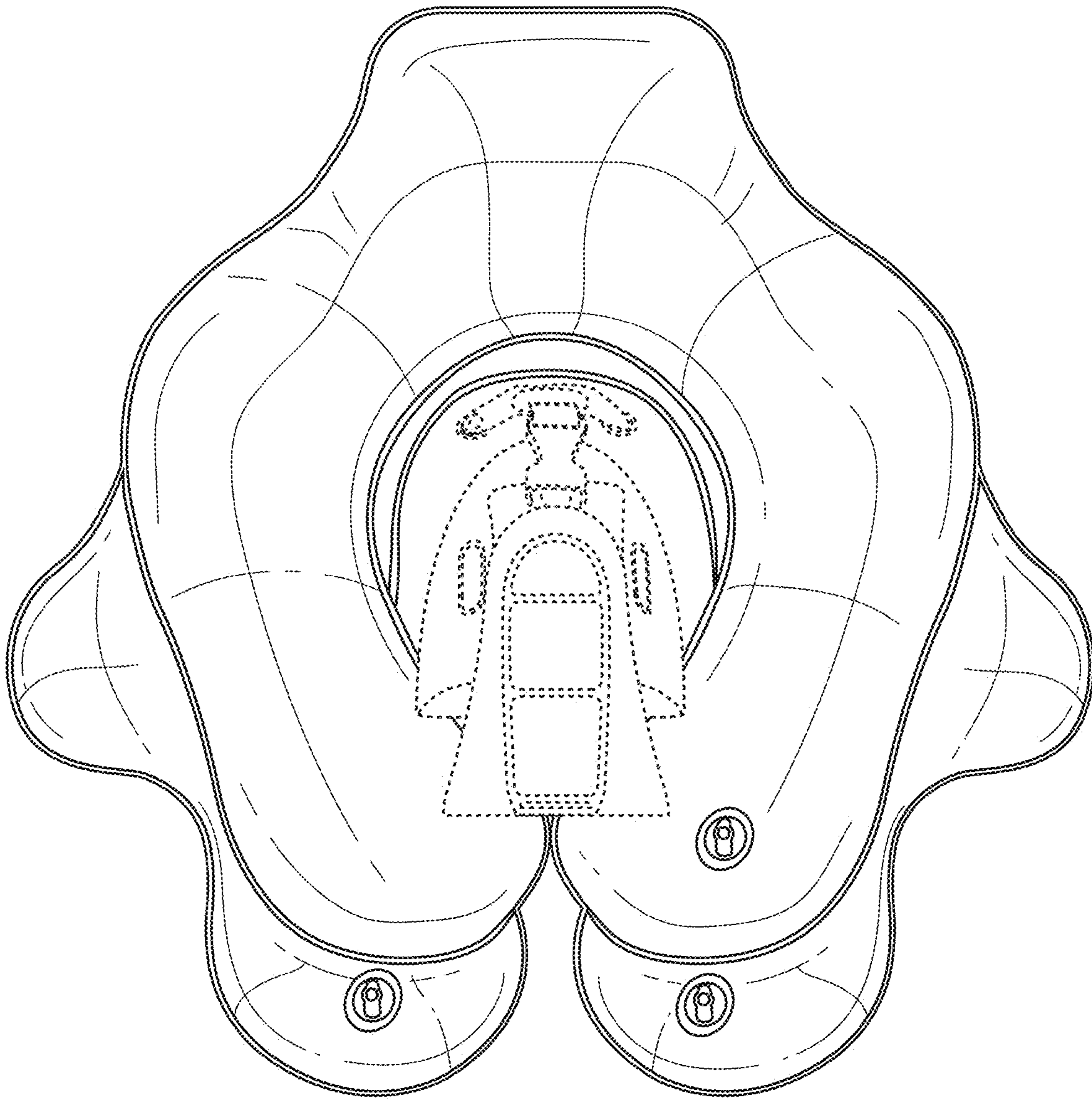

Fig. 3

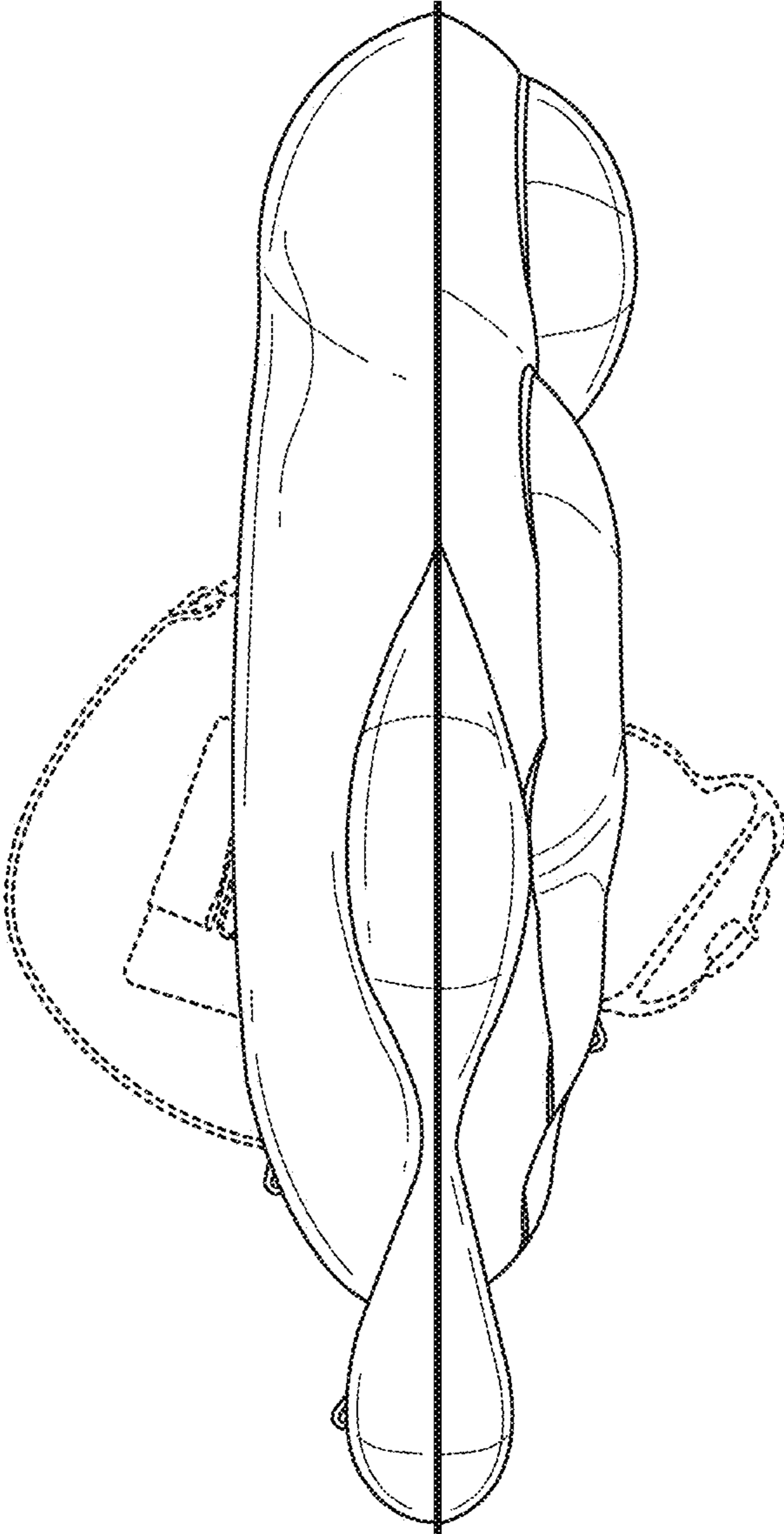

Fig. 4

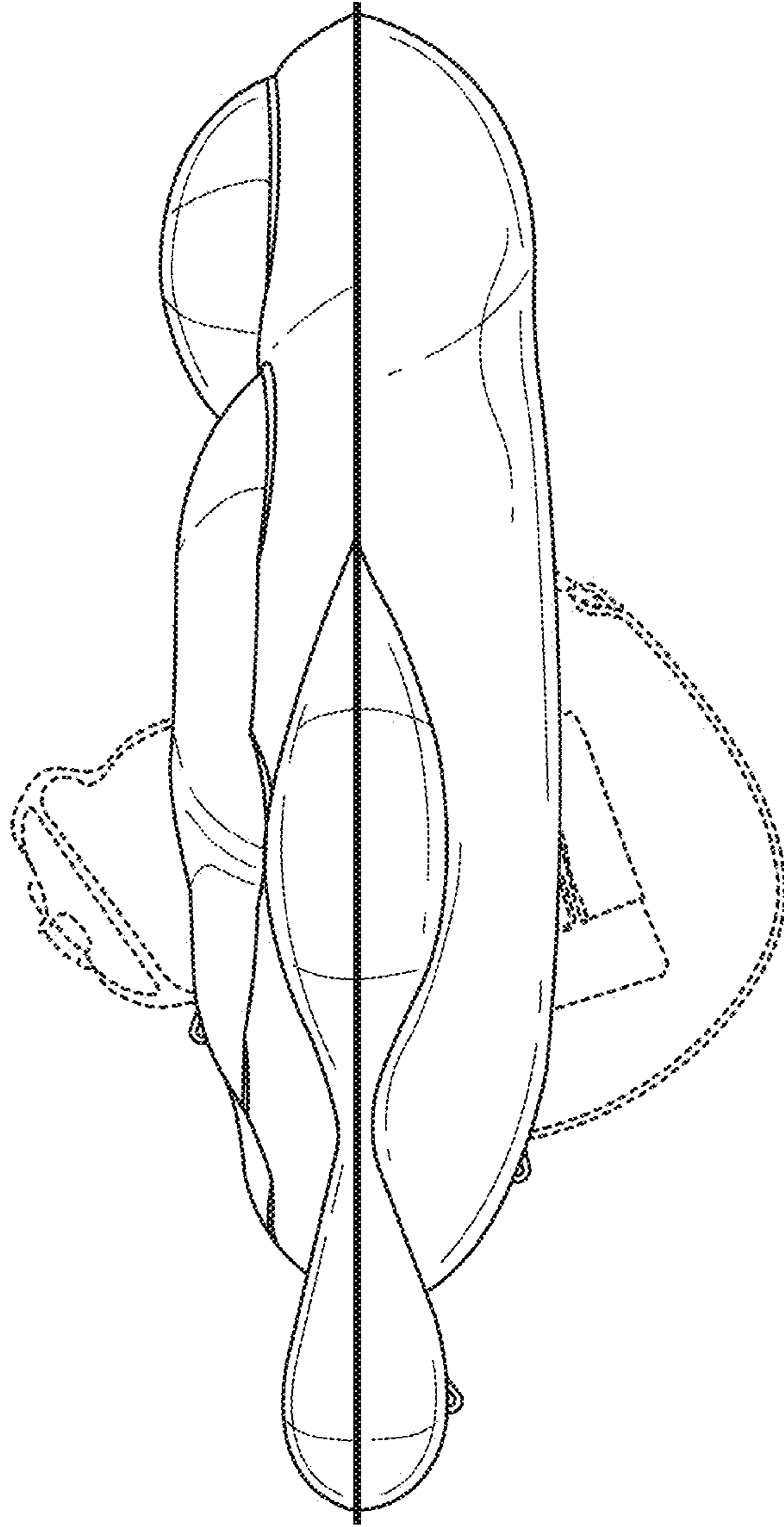

Fig. 5

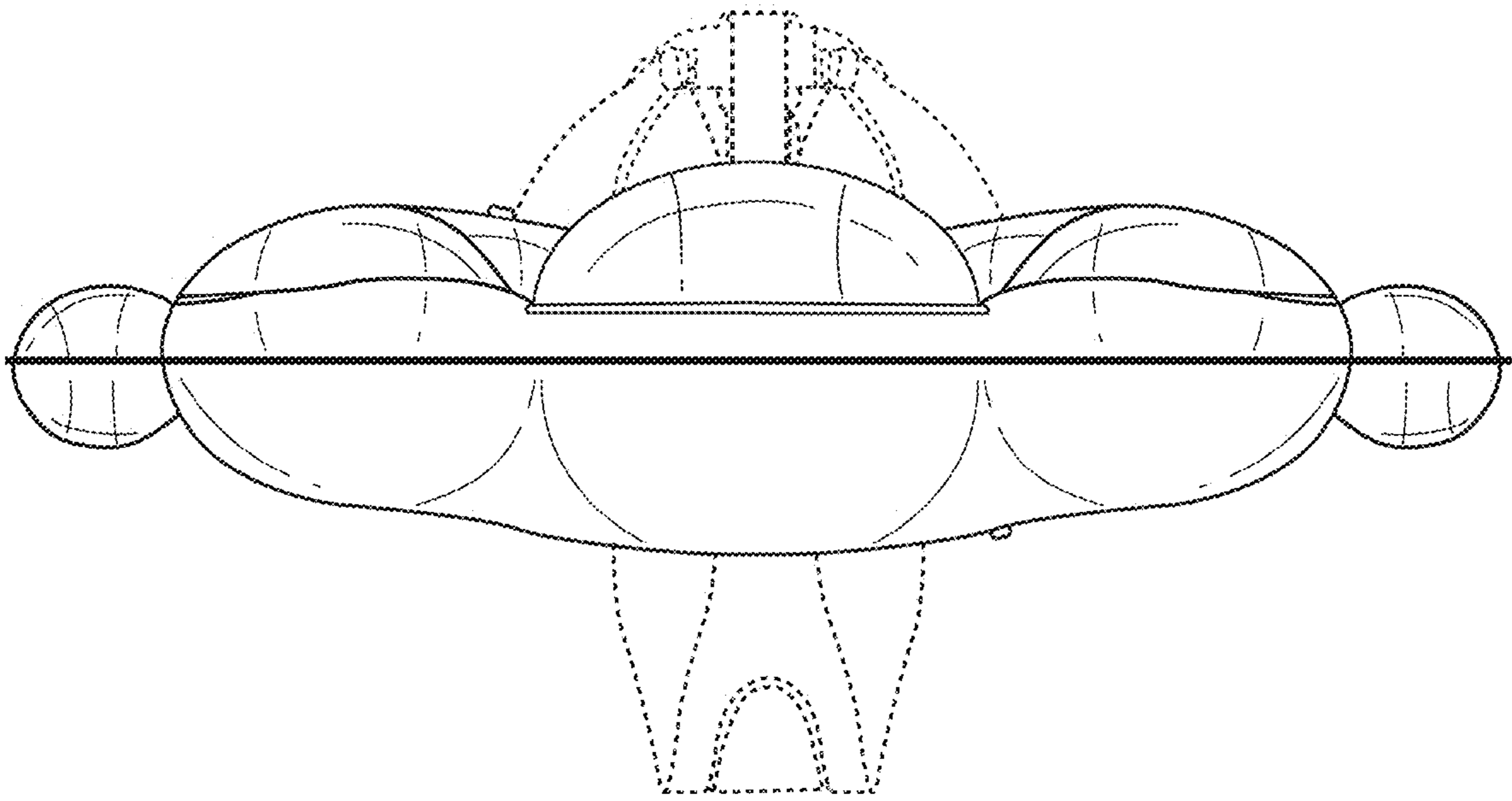

Fig. 6

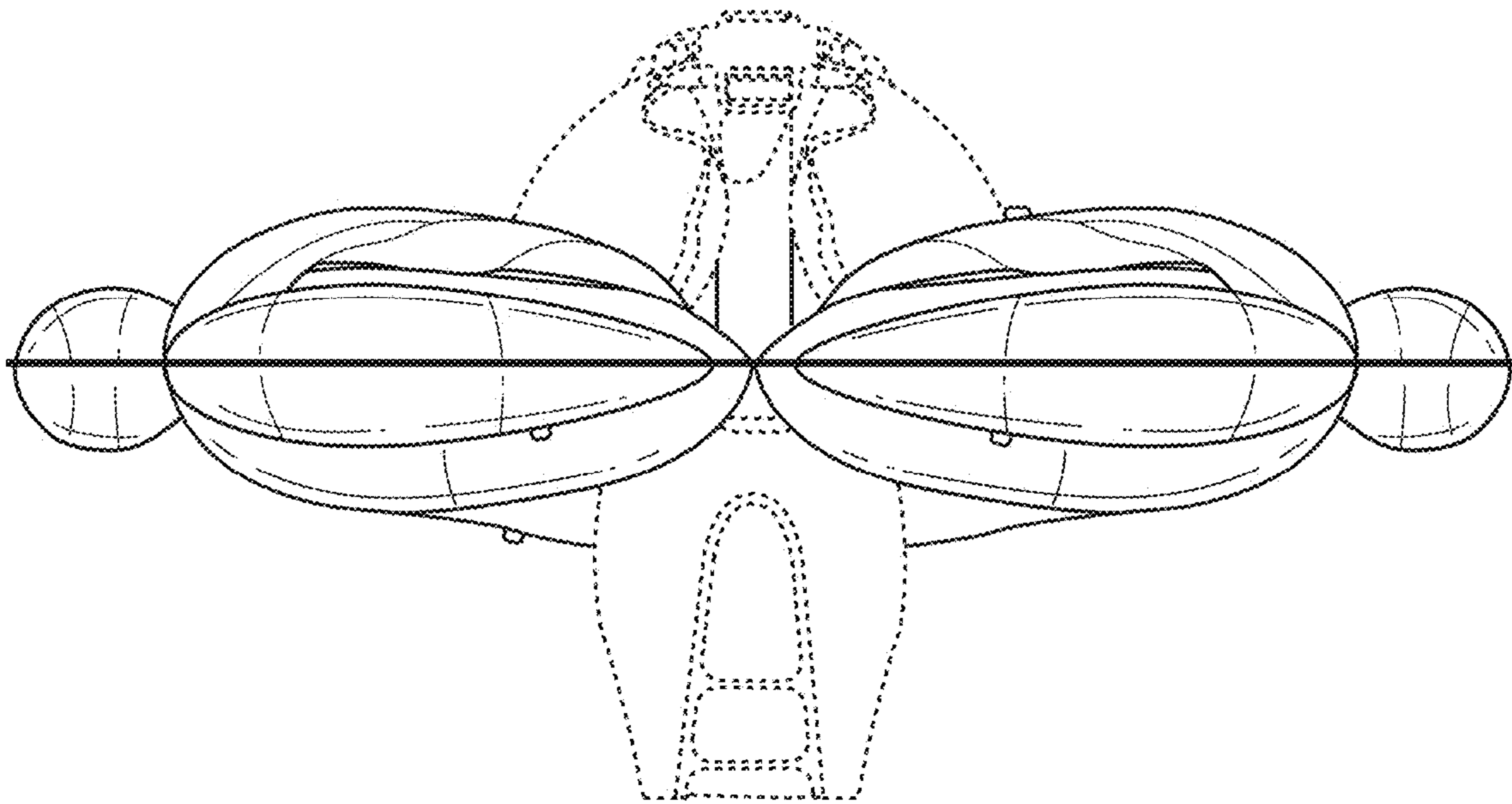

Fig. 7