



US00D984430S

(12) **United States Design Patent**
Zhao

(10) **Patent No.:** **US D984,430 S**

(45) **Date of Patent:** **** *Apr. 25, 2023**

(54) **MOBILE PHONE SHELL**

(71) Applicant: **Xiao Zhao**, Shenzhen (CN)

(72) Inventor: **Xiao Zhao**, Shenzhen (CN)

(*) Notice: This patent is subject to a terminal disclaimer.

(**) Term: **15 Years**

(21) Appl. No.: **29/849,587**

(22) Filed: **Aug. 12, 2022**

(30) **Foreign Application Priority Data**

Jun. 23, 2022 (CN) 202230390815.0

(51) **LOC (14) Cl.** **14-03**

(52) **U.S. Cl.**
USPC **D14/250**

(58) **Field of Classification Search**
USPC D14/250, 203.3–203.7, 439, 251–253,
D14/447, 217, 240, 238.1, 440, 248;
D3/247, 249, 269, 273, 301, 303
(Continued)

(56) **References Cited**

U.S. PATENT DOCUMENTS

2,815,126 A * 12/1957 Deckers A61F 15/001
150/147
D543,359 S * 5/2007 Suppangig D3/247
(Continued)

FOREIGN PATENT DOCUMENTS

CN 301967396 * 6/2012
KR 300740444.0000 * 4/2014

OTHER PUBLICATIONS

Strapurs, “iPhone 13 Pro Max Case Wallet . . .”, available at amazon.com, date first available Aug. 10, 2022, site visited Nov. 1, 2022, available at URL: <https://a.co/d/8PFN6oJ> (Year: 2022).*

(Continued)

Primary Examiner — Daniel J Domino

Assistant Examiner — Samina Vieth

(74) *Attorney, Agent, or Firm* — Runit Ranjit Kanakia

(57) **CLAIM**

The ornamental design for a mobile phone shell, as shown and described.

DESCRIPTION

FIG. 1 is a perspective view of the first embodiment of a mobile phone shell showing my new design;
FIG. 2 is a front view of the first embodiment thereof;
FIG. 3 is a back view of the first embodiment thereof;
FIG. 4 is a left side view of the first embodiment thereof;
FIG. 5 is a right side view of the first embodiment thereof;
FIG. 6 is a top view of the first embodiment thereof;
FIG. 7 is a bottom view of the first embodiment thereof;
FIG. 8 is a perspective view of another state of the first embodiment of the mobile phone shell thereof;
FIG. 9 is a perspective view of another state of the first embodiment of the mobile phone shell thereof;
FIG. 10 is a perspective view of another state of the first embodiment of the mobile phone shell thereof;
FIG. 11 is a perspective view of the second embodiment of a mobile phone shell showing my new design;
FIG. 12 is a front view of the second embodiment thereof;
FIG. 13 is a back view of the second embodiment thereof;
FIG. 14 is a left side view of the second embodiment thereof;
FIG. 15 is a right side view of the second embodiment thereof;
FIG. 16 is a top view of the second embodiment thereof;
FIG. 17 is a bottom view of the second embodiment thereof;
FIG. 18 is a perspective view of another state of the second embodiment of the mobile phone shell thereof;
FIG. 19 is a perspective view of another state of the second embodiment of the mobile phone shell thereof; and,
FIG. 20 is a perspective view of another state of the second embodiment of the mobile phone shell thereof.

(Continued)

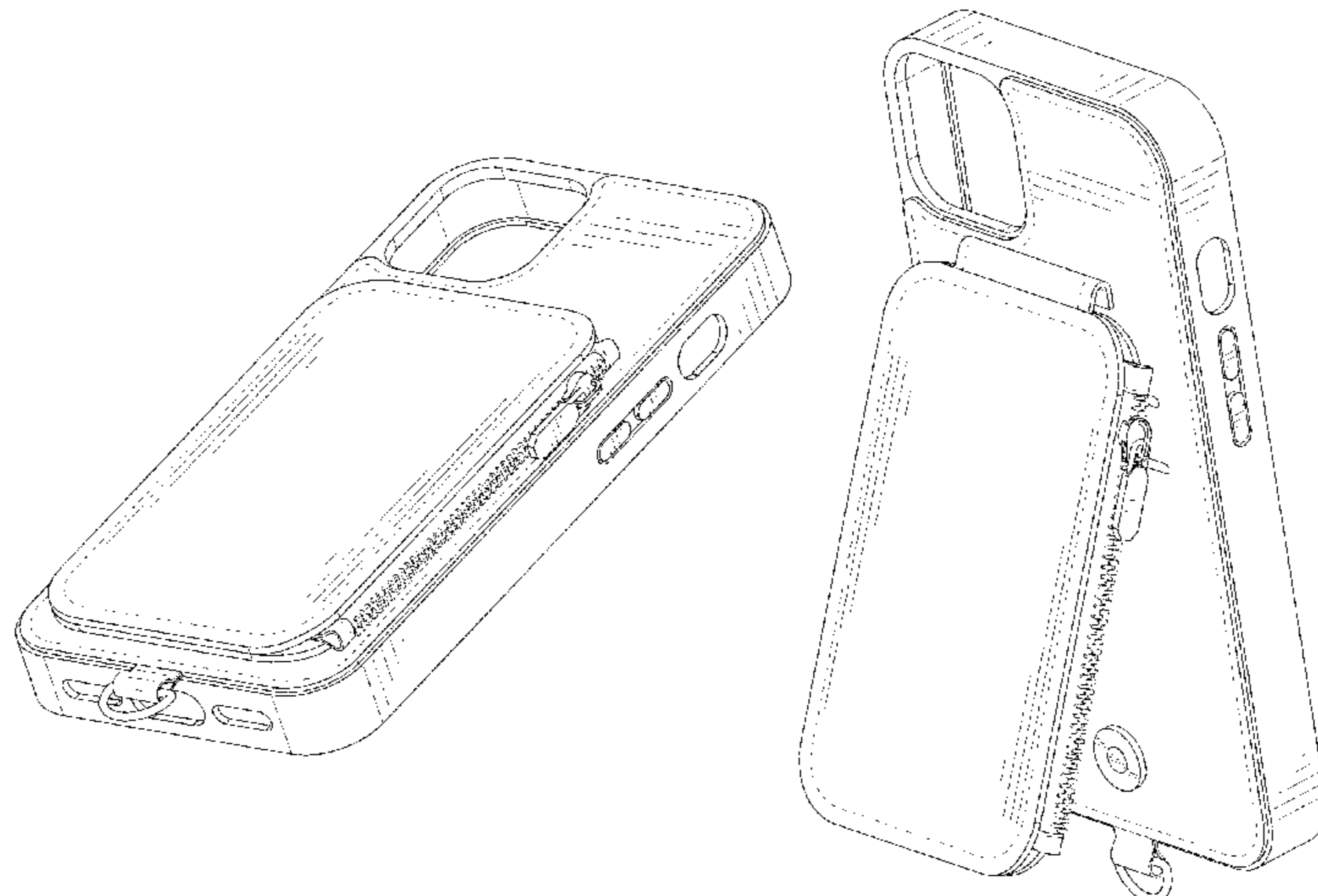

The broken lines shown in the drawings depict portions of the mobile phone shell that form no part of the claimed design.

1 Claim, 20 Drawing Sheets

(58) **Field of Classification Search**

CPC ... H04B 1/3888; A45C 1/06; A45C 2011/002;
A45F 2005/028; A45F 2200/0525
See application file for complete search history.

(56) **References Cited**

U.S. PATENT DOCUMENTS

| | | | | | |
|------------|---|---------|---------|-------|---------|
| D559,532 S | * | 1/2008 | Kwak | | D3/218 |
| D683,960 S | * | 6/2013 | Robbins | | D3/269 |
| D767,888 S | * | 10/2016 | Kim | | D3/249 |
| D802,575 S | * | 11/2017 | Castro | | D14/250 |
| D803,558 S | * | 11/2017 | Liu | | D3/247 |
| D827,629 S | * | 9/2018 | Yu | | D14/250 |
| D830,354 S | * | 10/2018 | Deng | | D3/249 |
| D843,992 S | * | 3/2019 | Lu | | D14/250 |
| D858,504 S | * | 9/2019 | Gellner | | D14/250 |
| D858,984 S | * | 9/2019 | Zucco | | D3/247 |
| D863,286 S | | 10/2019 | Hong | | |
| D887,129 S | * | 6/2020 | Zhao | | D3/226 |
| D899,411 S | * | 10/2020 | Liu | | D3/249 |
| D900,800 S | * | 11/2020 | Sirju | | D3/249 |

| | | | | | |
|------------|---|---------|------|-------|---------|
| D903,315 S | * | 12/2020 | Liu | | D3/249 |
| D906,321 S | * | 12/2020 | Feng | | D3/249 |
| D906,325 S | * | 12/2020 | Zhao | | D14/250 |
| D917,442 S | * | 4/2021 | Feng | | D3/249 |
| D918,887 S | * | 5/2021 | Feng | | D3/249 |
| D929,388 S | * | 8/2021 | Guo | | D14/250 |
| D935,447 S | | 11/2021 | Xu | | |
| D960,140 S | * | 8/2022 | He | | D14/250 |

OTHER PUBLICATIONS

Hoerrye Store, "Crossbody Wallet Women Case for iPhone 14 . . ." available at amazon.com, date first available Jul. 15, 2022, site visited Nov. 1, 2022, available at URL: <https://a.co/d/0tJuQ7r> (Year: 2022).*

TopPerfekt Store, "2022 Compatibe with iPhone 14 Pro Wallet Case . . .", available at amazon.com, date first available Sep. 30, 2022, site visited: Nov. 1, 2022, available at URL: <https://a.co/d/aSVcrFN> (Year: 2022).*

Lameeku, "iPhone 12 Pro/iPhone 12 Wallet Case . . ." available at amazon.com, date first available Oct. 8, 2021, site visited Nov. 1, 2022, available at URL: <https://a.co/d/7qqZdVH> (Year: 2021).*

LakiBeibi, "Phone Case for iPhone 11 Dual Layer . . .", available at amazon.com, date first available: Sep. 11, 2019, site visited Nov. 1, 2022, available at URL: <https://a.co/d/iDPaGHk> (Year: 2019).*

Fodelight, "for iphone 14 pro Max 14 . . ." available at ebay.com, date published Aug. 6, 2022, site visited Nov. 1, 2022, available at URL: <https://www.ebay.com/itm/255664010658> (Year: 2022).*

* cited by examiner

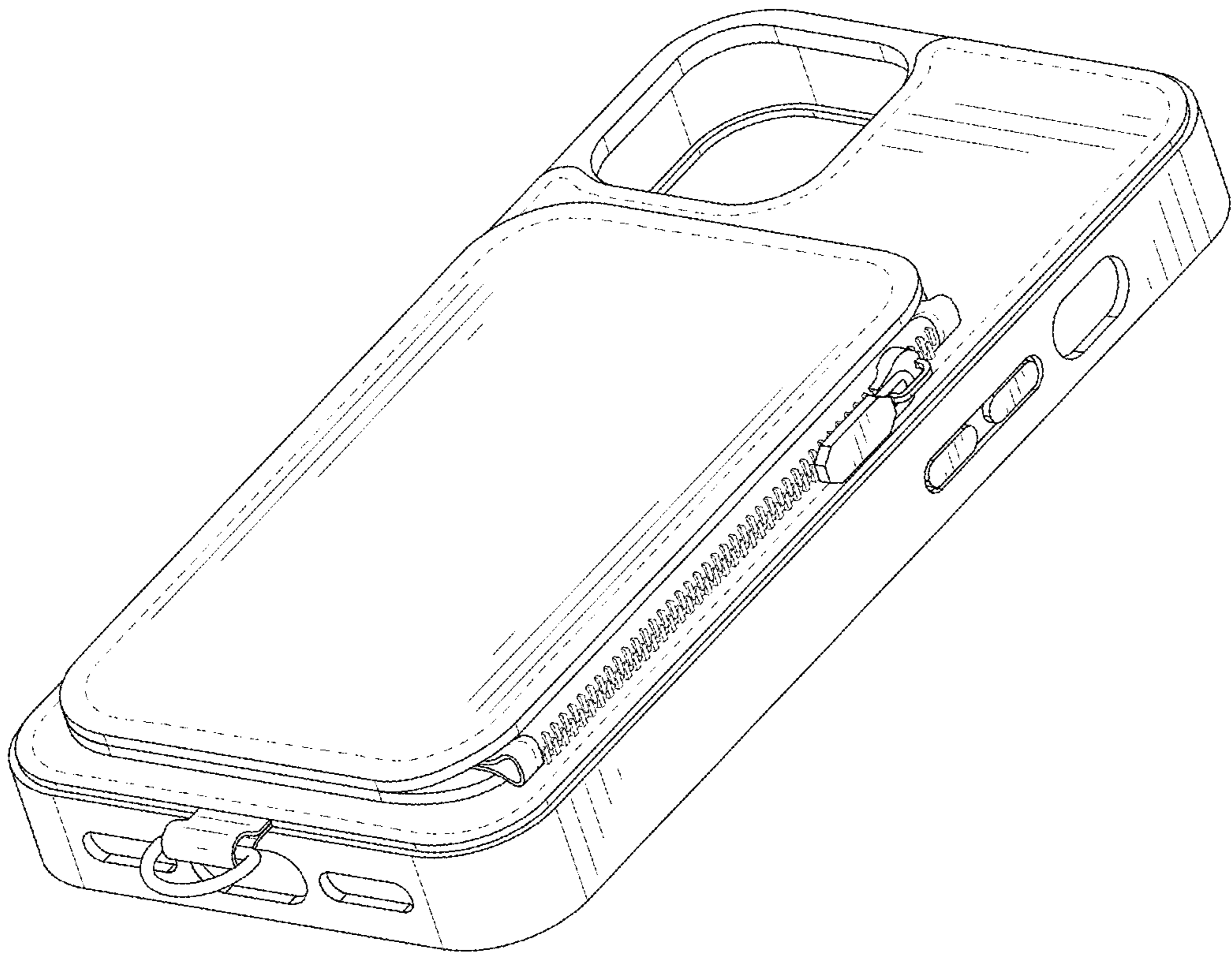

FIG. 1

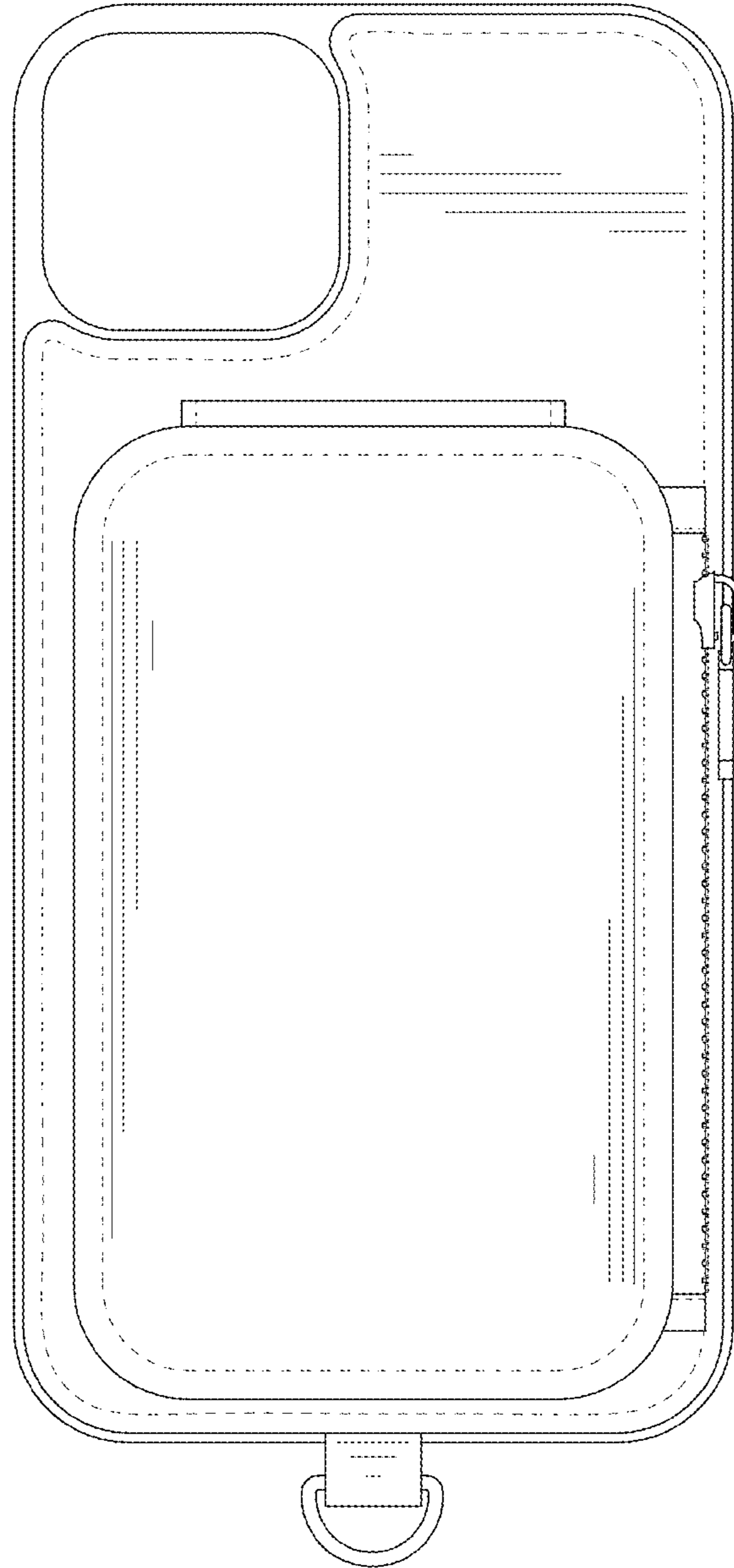

FIG. 2

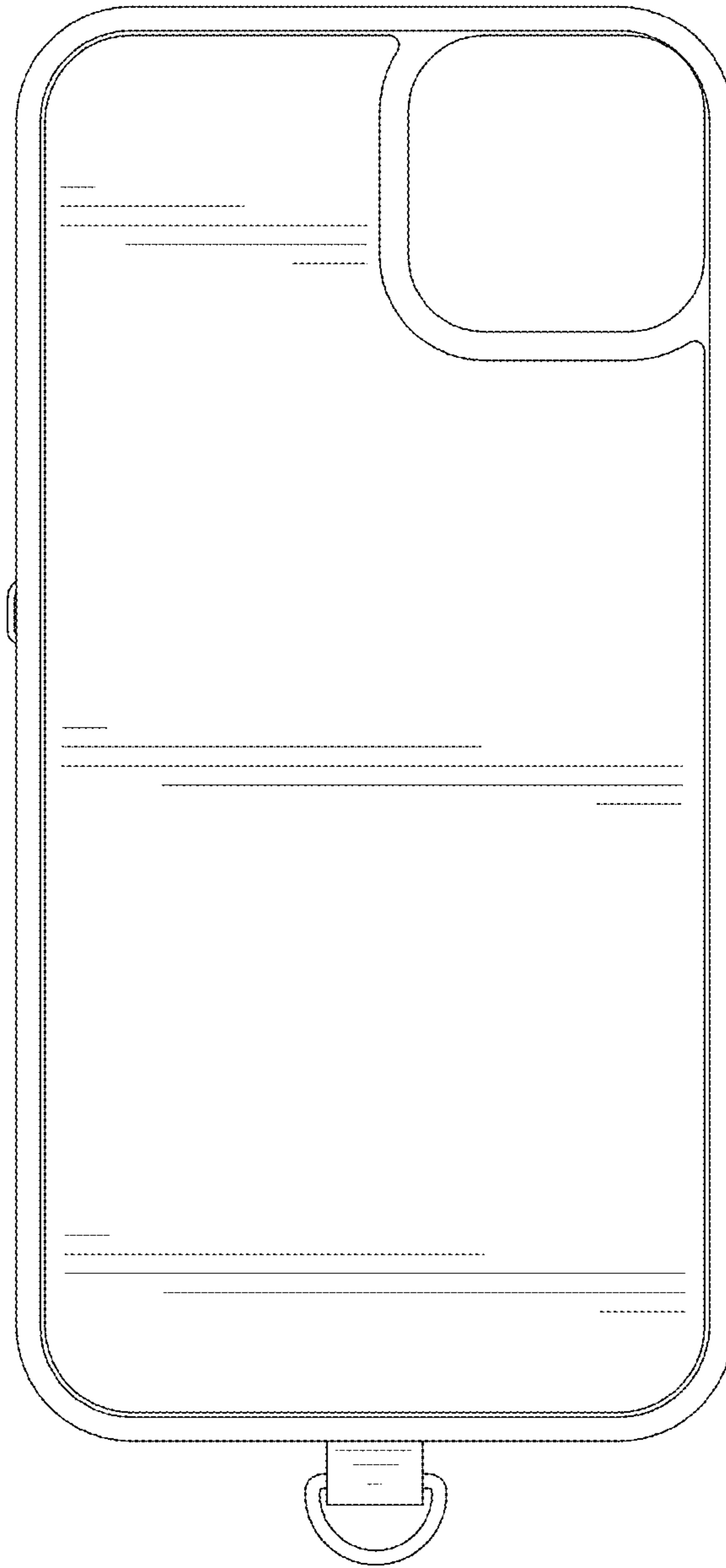

FIG. 3

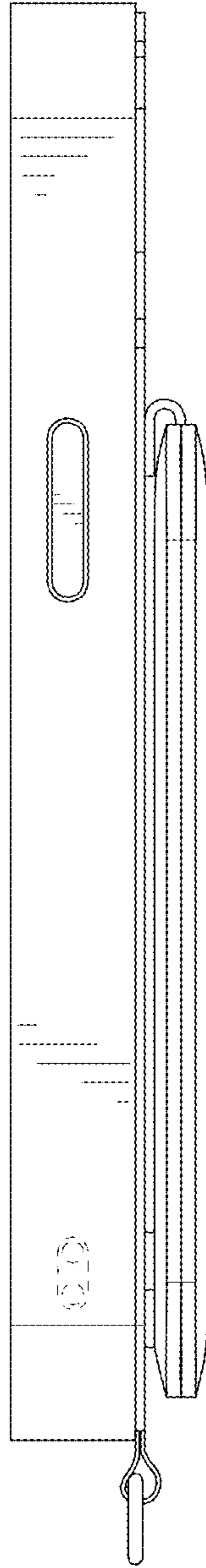

FIG. 4

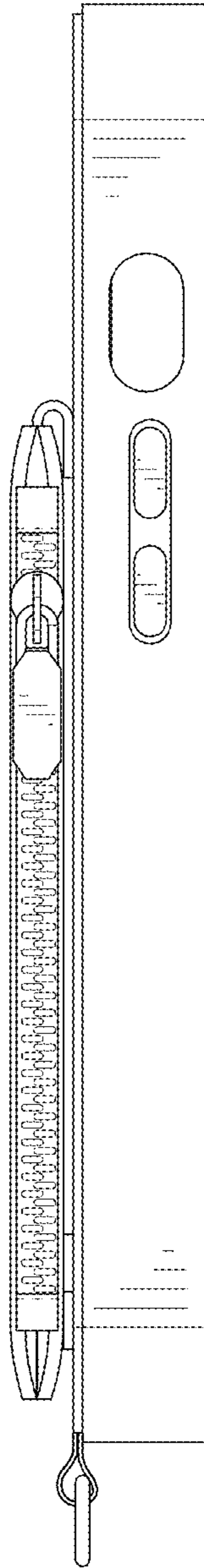

FIG. 5

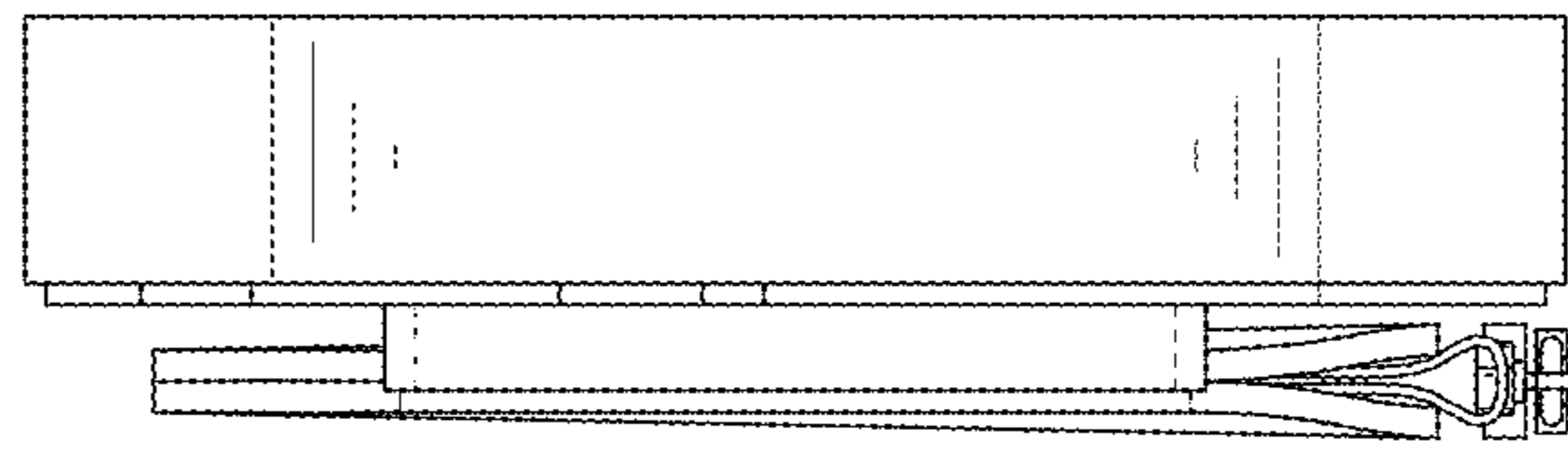

FIG. 6

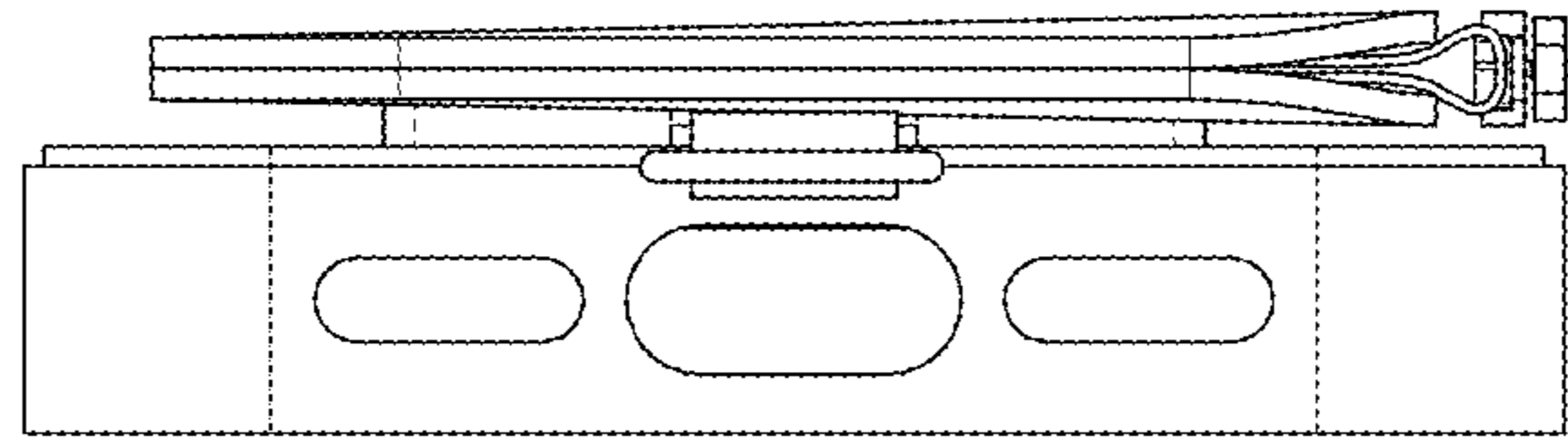

FIG. 7

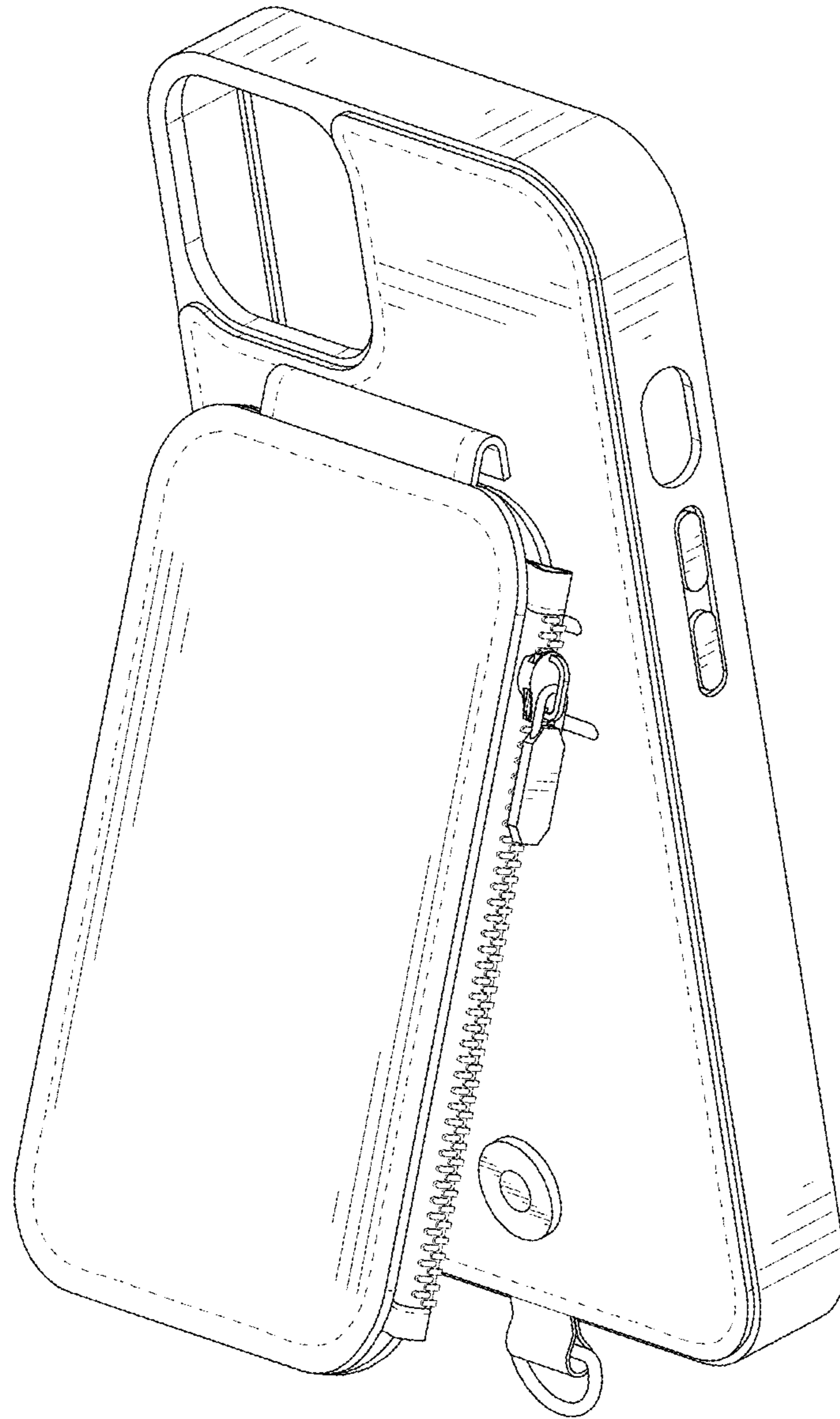

FIG. 8

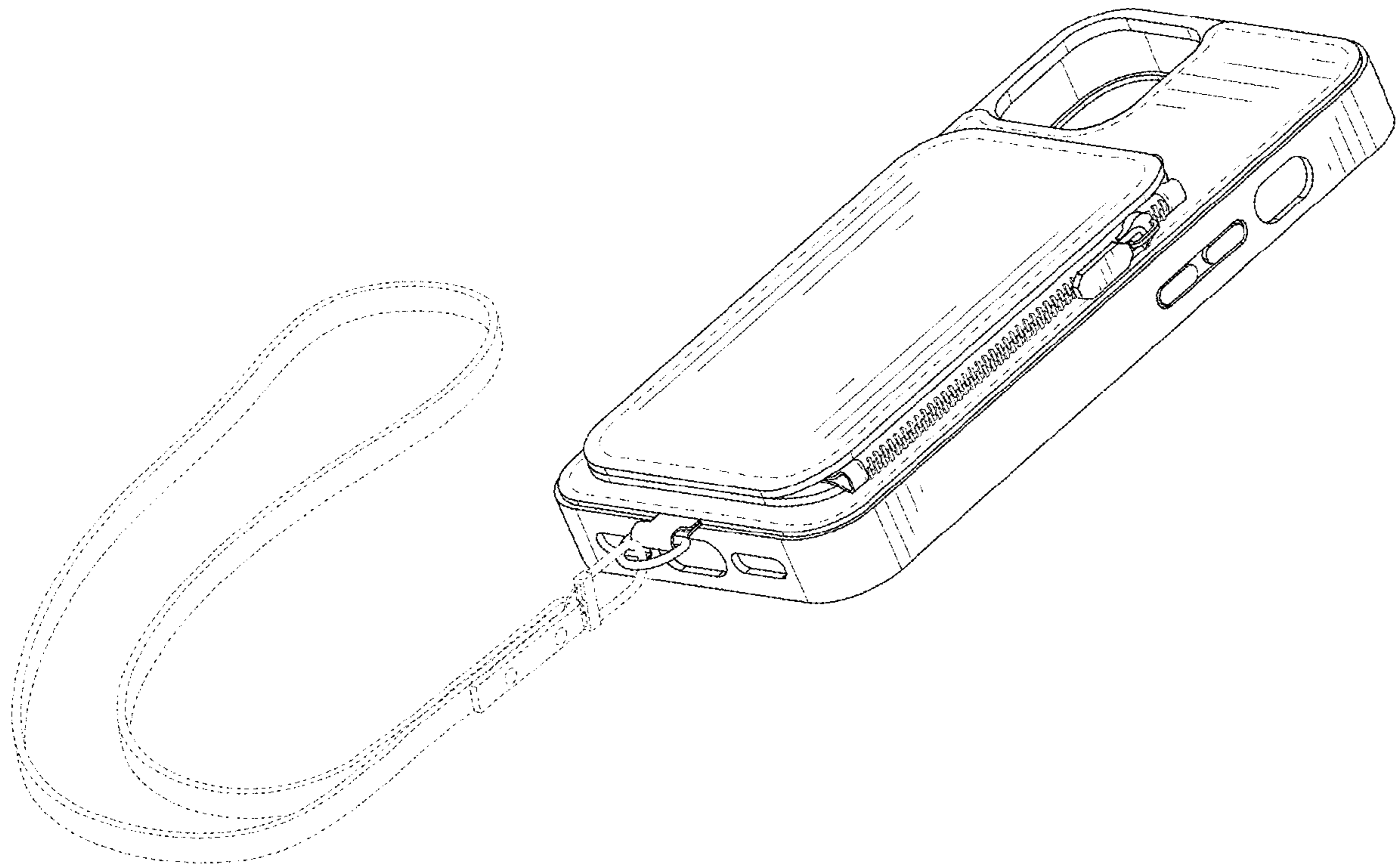

FIG. 9

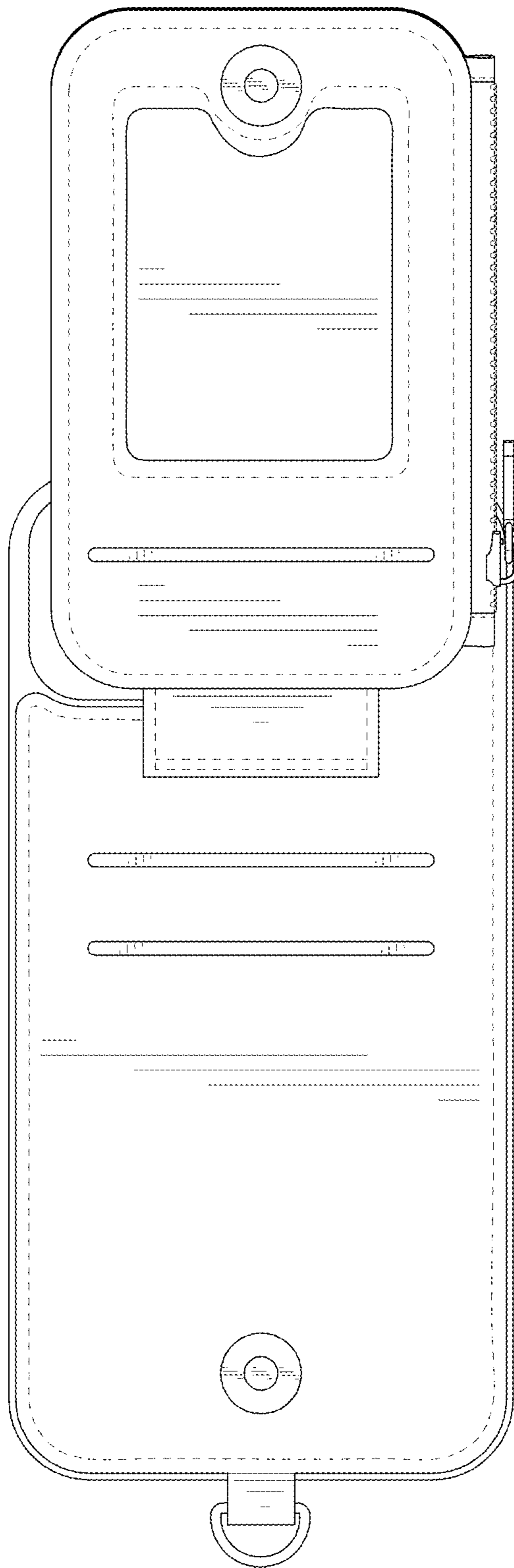

FIG. 10

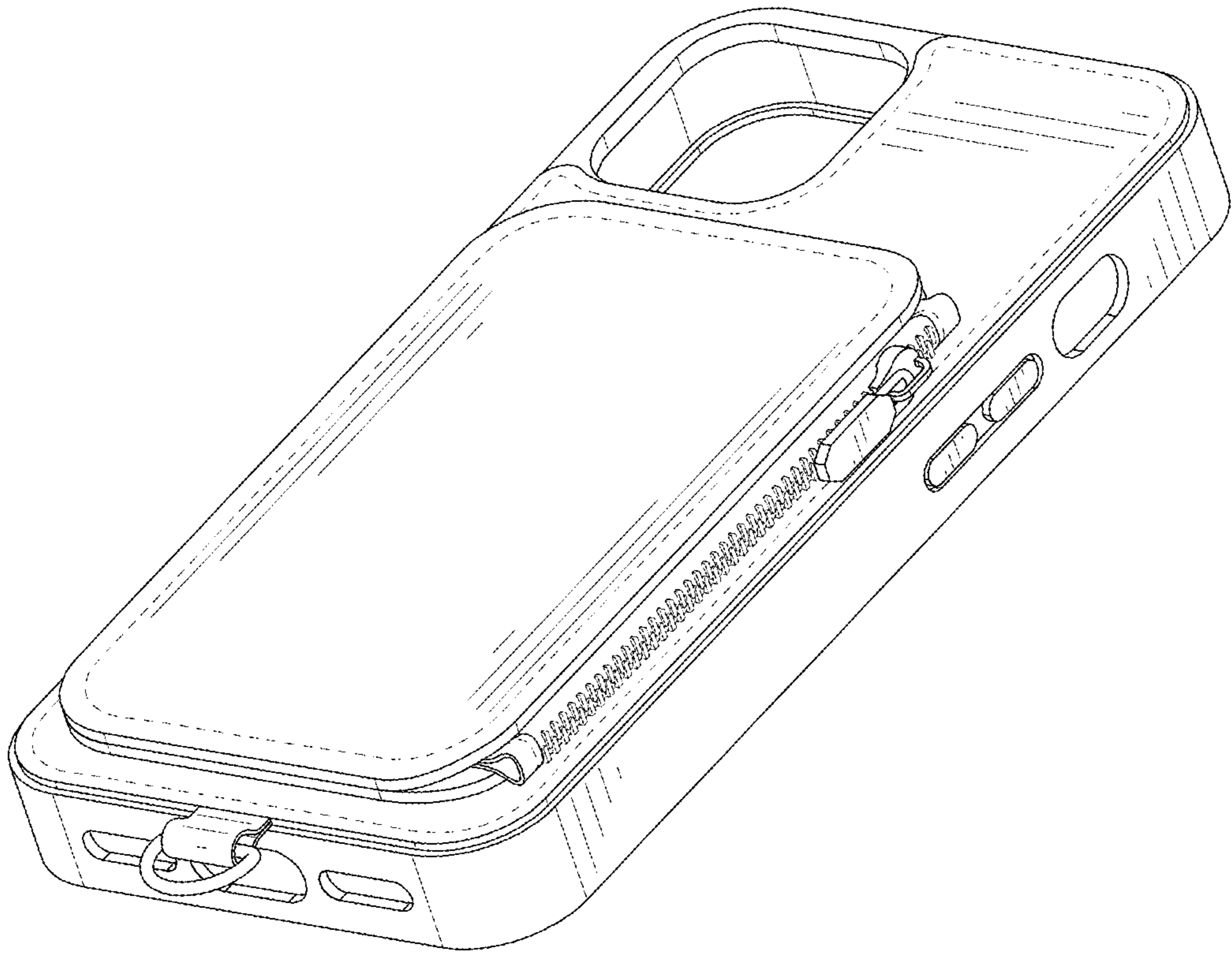

FIG. 11

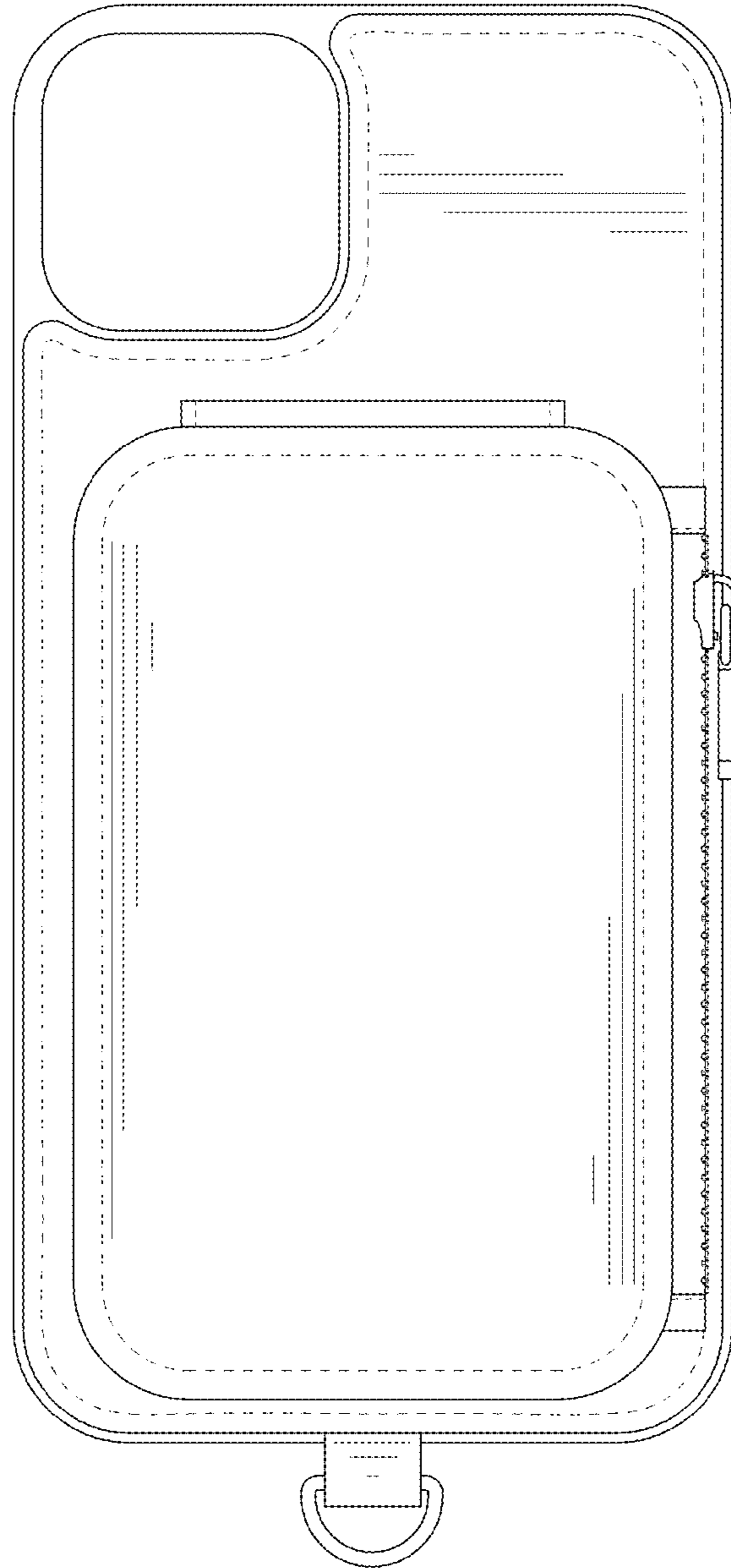

FIG. 12

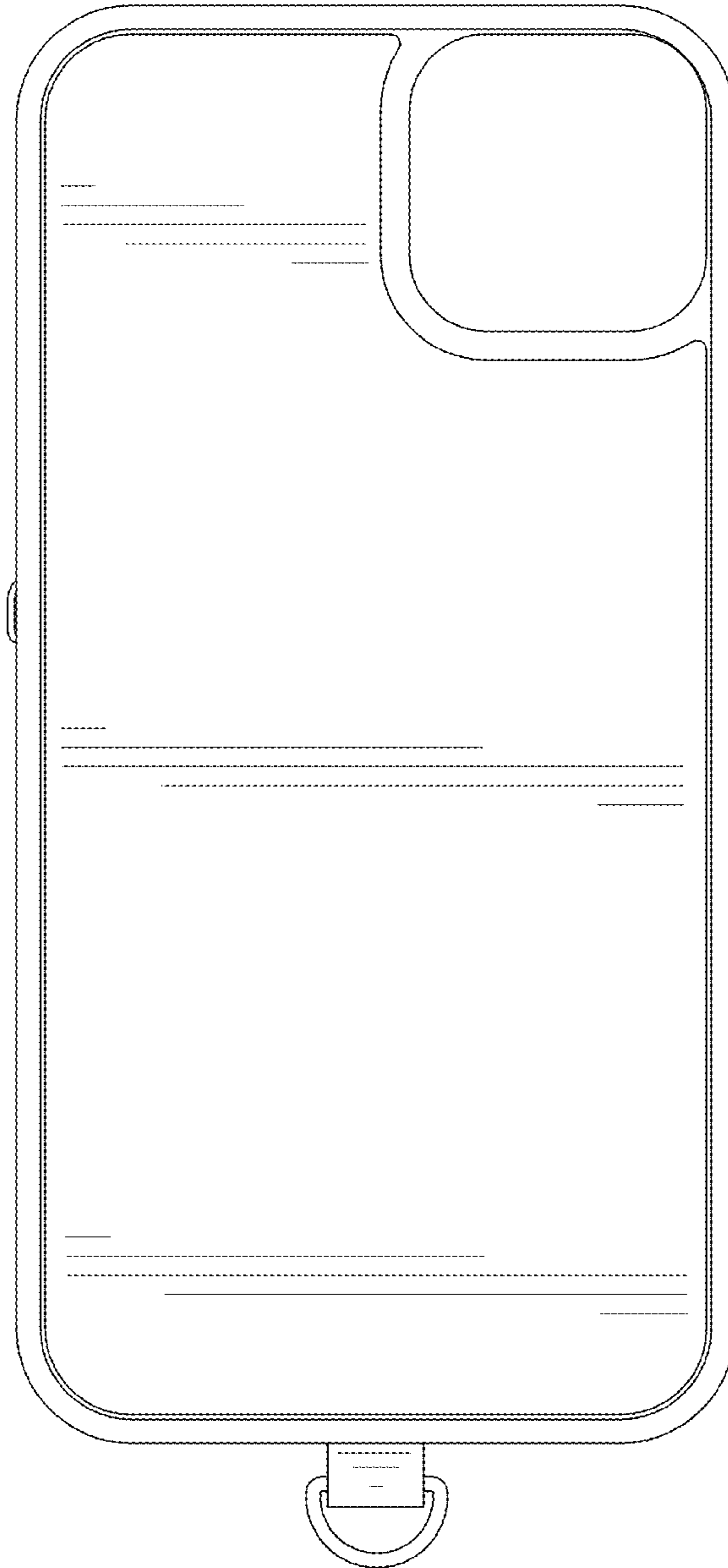

FIG. 13

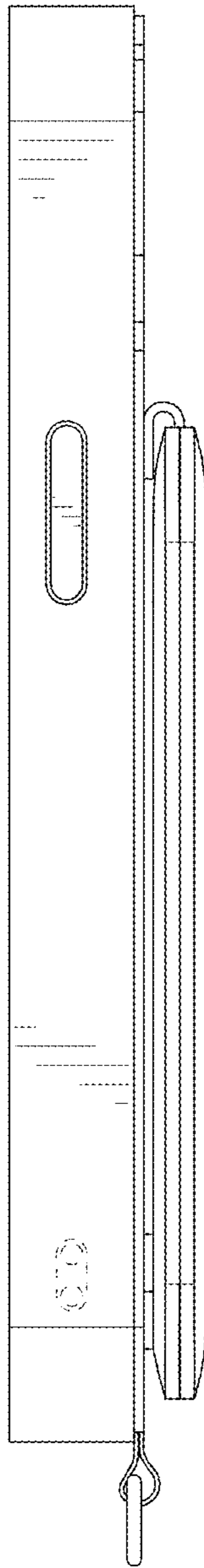

FIG. 14

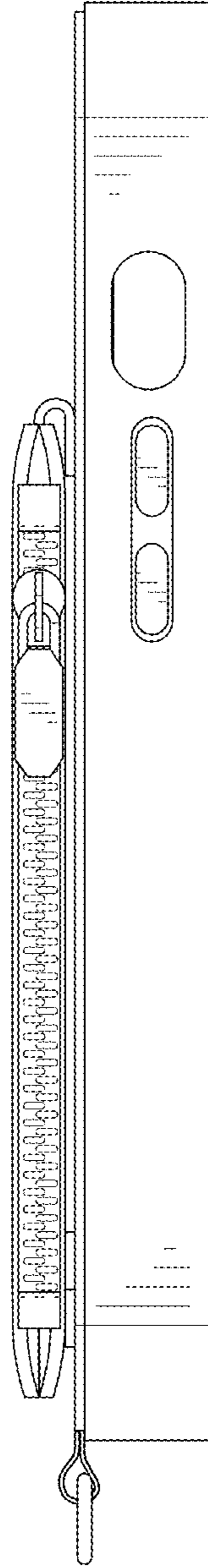

FIG. 15

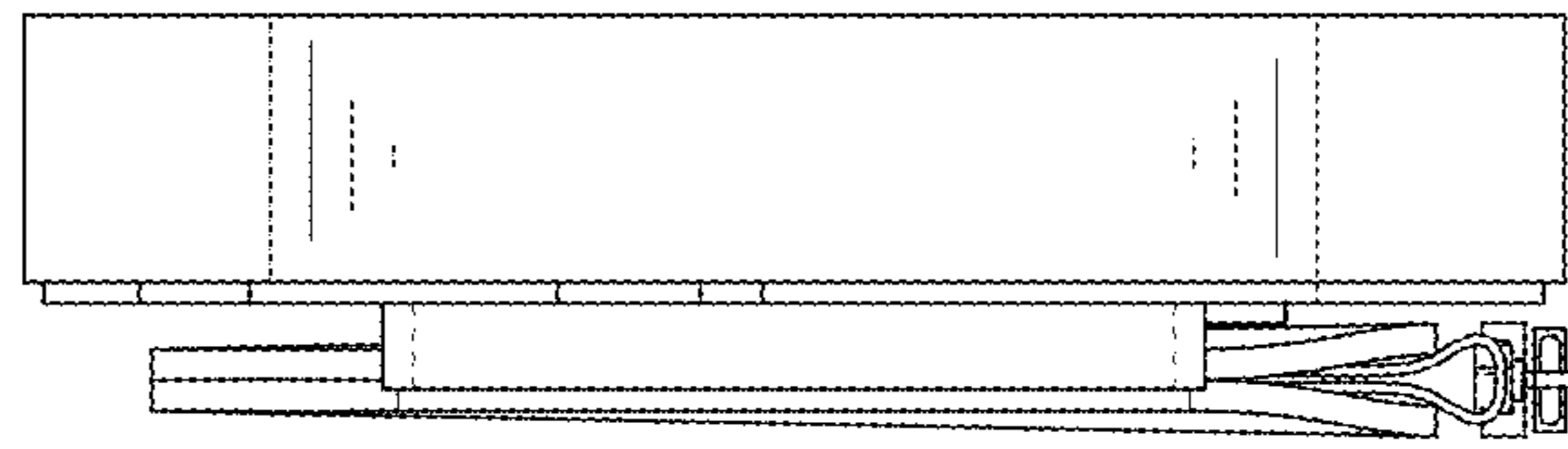

FIG. 16

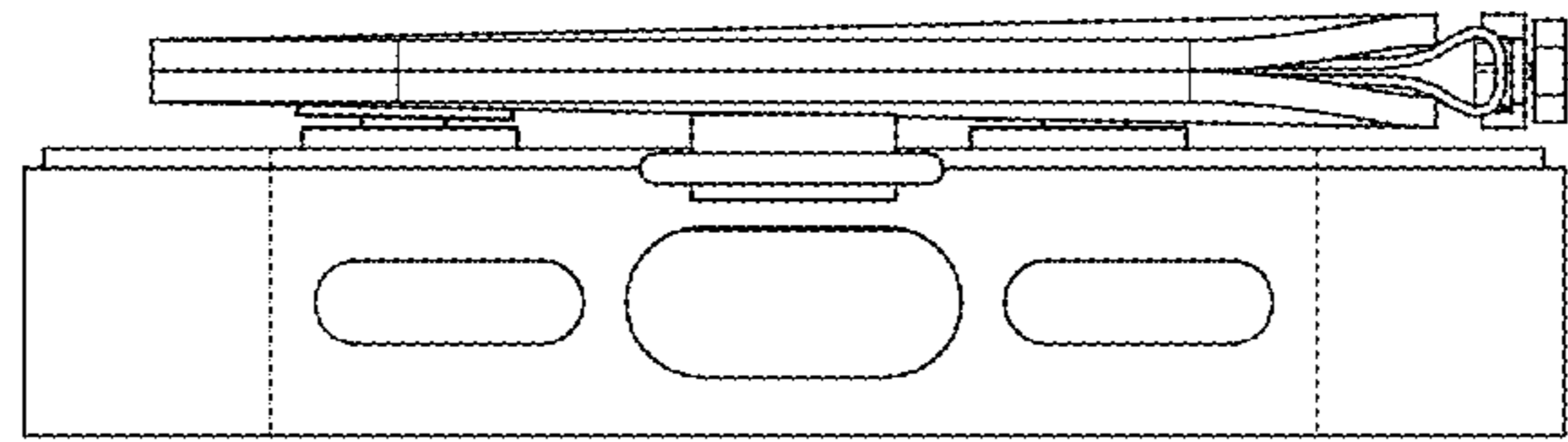

FIG. 17

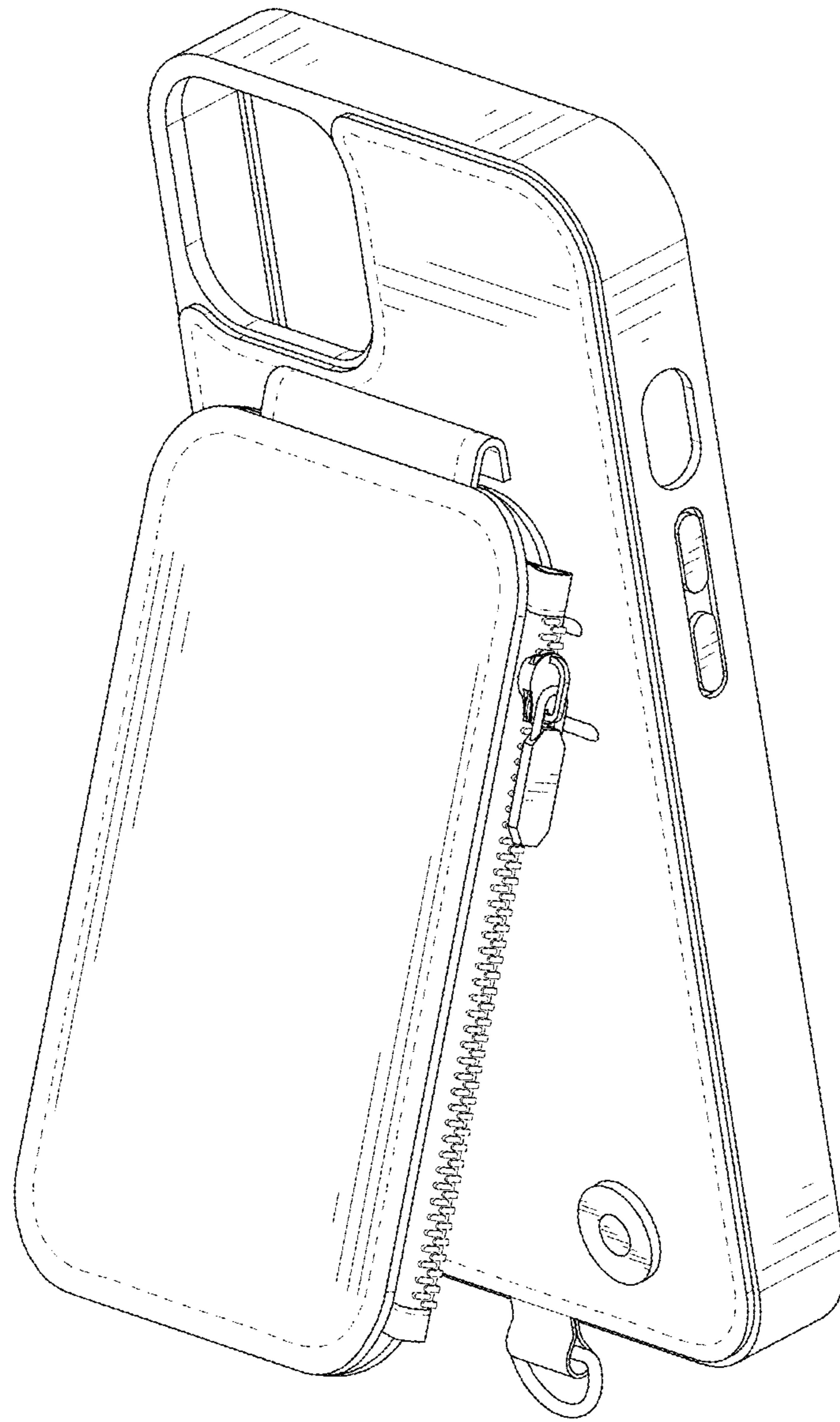

FIG. 18

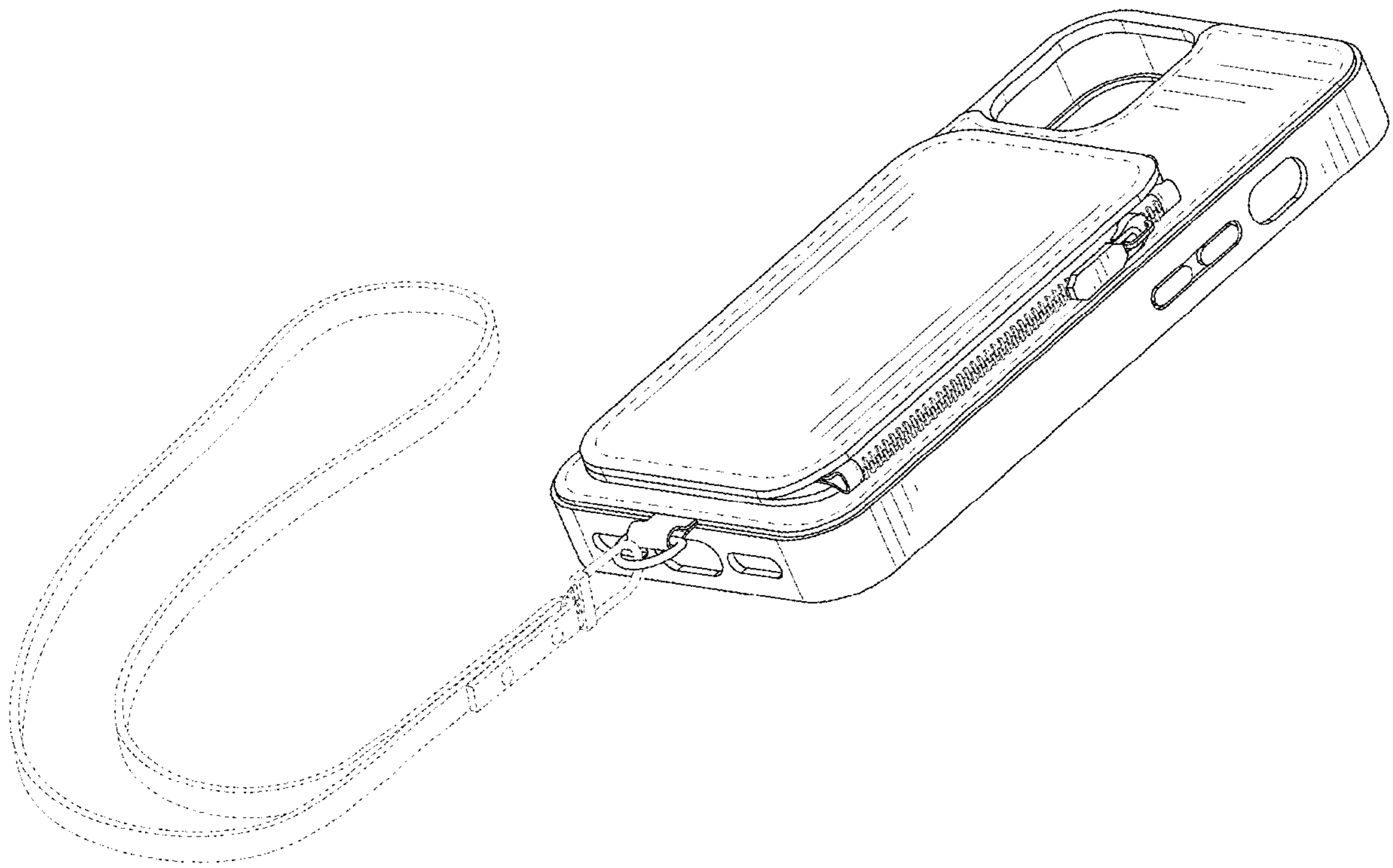

FIG. 19

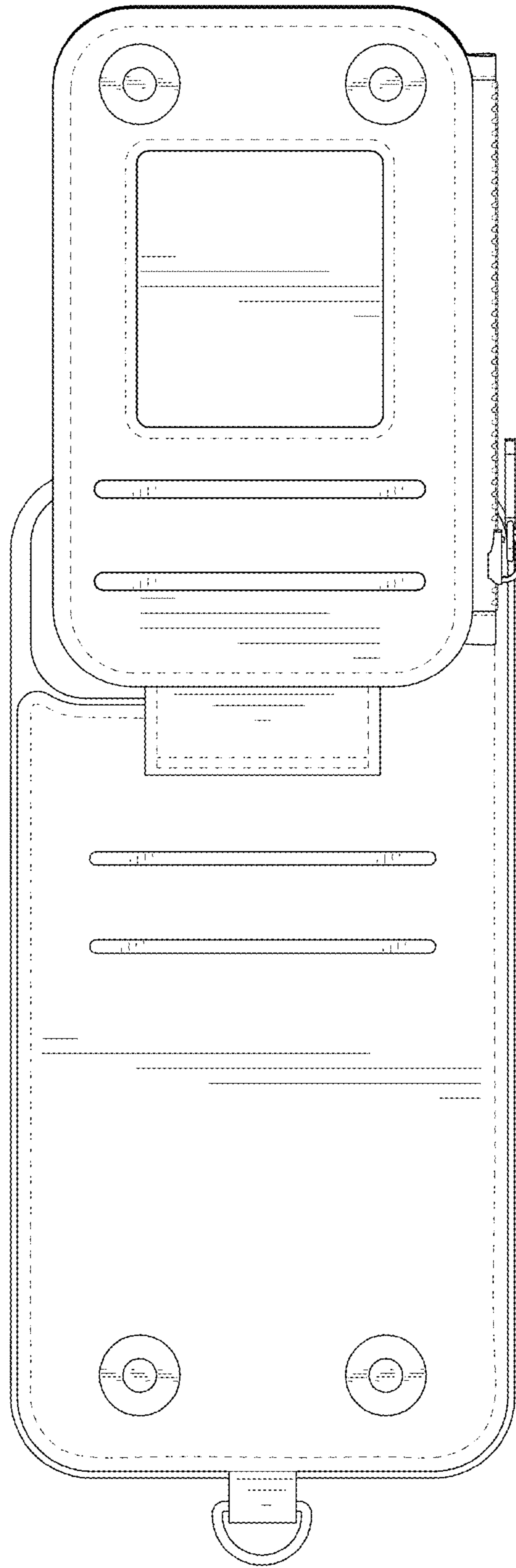

FIG. 20