



US00D984421S

(12) **United States Design Patent**
Deng

(10) **Patent No.:** **US D984,421 S**
(45) **Date of Patent:** **** Apr. 25, 2023**

(54) **WIRELESS EARPHONES WITH CHARGING CASE**

(71) Applicant: **Besing Technology (Shenzhen) Co., Ltd.**, Shenzhen (CN)

(72) Inventor: **Wenfeng Deng**, Shenzhen (CN)

(73) Assignee: **BESING TECHNOLOGY (SHENZHEN) CO., LTD.**, Shenzhen (CN)

(**) Term: **15 Years**

(21) Appl. No.: **29/802,978**

(22) Filed: **Aug. 10, 2021**

(51) **LOC (14) Cl.** **14-01**

(52) **U.S. Cl.**
USPC **D14/223**

(58) **Field of Classification Search**
USPC D14/223, 205; D13/107, 108; D3/201, D3/294, 274, 295, 289; D9/420, 430, D9/456, 435, 424, 521, 529, 432, 447; D28/76, 82, 88, 66, 73, 78; 381/380-381, 322, 328; 206/266; 455/575.2; 132/315, 294
CPC H04R 1/10; H04R 25/00; H04R 25/02; H04R 1/1066; H04R 1/1025; H04R 1/1041; H04R 1/105; H02J 7/0047; H04B 1/02;

(Continued)

(56) **References Cited**

U.S. PATENT DOCUMENTS

2,219,597 A * 10/1940 Lutz A45D 29/20 132/73
3,043,354 A * 7/1962 Fitzgerald B65D 25/04 220/4.23

(Continued)

FOREIGN PATENT DOCUMENTS

GB 6197685 * 3/2022
GB 6234682 * 9/2022
IN 349159-001-0001 * 9/2021

Primary Examiner — Paula Allen Greene

(57) **CLAIM**

The ornamental design for wireless earphones with charging case, as shown and described.

DESCRIPTION

FIG. 1 is a perspective view of wireless earphones of wireless earphones with charging case, shown separately for ease of illustration;
FIG. 2 is another perspective view thereof;
FIG. 3 is a front elevational view thereof;
FIG. 4 is a rear elevational view thereof;
FIG. 5 is a left side elevational view thereof;
FIG. 6 is a right side elevational view thereof;
FIG. 7 is a top plan view thereof;
FIG. 8 is a bottom plan view thereof;
FIG. 9 is a perspective view of the charging case of the wireless earphones with charging case, shown separately for ease of illustration and in an open configuration;
FIG. 10 is another perspective view thereof;
FIG. 11 is a front elevational view thereof;
FIG. 12 is a rear elevational view thereof;
FIG. 13 is a left side elevational view thereof;
FIG. 14 is a right side elevational view thereof;
FIG. 15 is a top plan view thereof;
FIG. 16 is a bottom plan view thereof;
FIG. 17 is a perspective view of the wireless earphones with charging case, where the wireless earphones are received in the charging case; and,
FIG. 18 is a perspective view of the charging case of the wireless earphones with charging case, shown separately for ease of illustration and in a closed configuration.
The broken lines in the drawings depict portions of the wireless earphones with charging case that form no part of the claimed design.

1 Claim, 18 Drawing Sheets



(58) **Field of Classification Search**
 CPC A45C 11/24; B65D 43/165; B65D 43/16;
 A45D 33/24
 See application file for complete search history.

(56) **References Cited**

U.S. PATENT DOCUMENTS

4,369,799 A * 1/1983 Napoleon A45D 33/00
 132/294
 5,638,838 A * 6/1997 Lombardi A45C 13/005
 132/294
 D400,011 S * 10/1998 Palmer D3/294
 5,842,487 A * 12/1998 Ledet A46B 11/0027
 401/175
 D413,893 S * 9/1999 Luzbetak D14/240
 6,199,559 B1 * 3/2001 Nikolaus A45C 13/008
 132/294
 D440,205 S * 4/2001 Lord D13/147
 D449,165 S * 10/2001 van der Hulst D3/294
 D469,770 S * 2/2003 Carpenter D14/433
 D470,833 S * 2/2003 Rath D14/205
 D506,611 S * 6/2005 Hiller D3/294
 D509,210 S * 9/2005 Skulley D14/206
 D510,187 S * 10/2005 Chan D3/247
 D531,025 S * 10/2006 Tanner D9/426
 D543,937 S * 6/2007 Rose D13/110
 D555,150 S * 11/2007 Christopher D14/223
 D556,571 S * 12/2007 Jalet D9/432
 D567,032 S * 4/2008 Gilbert D7/629
 D582,899 S * 12/2008 Wai D14/223
 D592,398 S * 5/2009 Roesler D3/294
 D592,399 S * 5/2009 Sage D3/295
 D592,494 S * 5/2009 Wichowski D9/414
 D601,383 S * 10/2009 Shah D7/538
 D609,009 S * 2/2010 Schaal D3/294
 D620,257 S * 7/2010 Fujimura D3/294
 D641,164 S * 7/2011 Cornu D3/294
 D665,253 S * 8/2012 Bellamah D9/424
 D694,102 S * 11/2013 Bellamah D9/424
 8,655,005 B2 * 2/2014 Birger H04R 1/1091
 381/381
 D708,850 S * 7/2014 Morine D3/294
 8,910,781 B2 * 12/2014 Pipes B65B 7/28
 220/780
 D725,637 S * 3/2015 Nakajima D14/223
 D731,793 S * 6/2015 Houghton D3/294
 D775,610 S * 1/2017 Nakajima D14/223
 D806,648 S * 1/2018 Beedham D13/107
 D811,745 S * 3/2018 Davi D3/218
 D838,480 S * 1/2019 Son D3/294

D841,581 S * 2/2019 Bonahoom D13/108
 D842,836 S * 3/2019 Ma D14/205
 D846,264 S * 4/2019 Wu D3/201
 D851,913 S * 6/2019 Yu D3/201
 D853,116 S * 7/2019 Bergman D3/294
 D863,265 S * 10/2019 Hu D14/223
 D864,110 S * 10/2019 Yoshimura D3/294
 D870,451 S * 12/2019 Birger D14/223
 10,530,176 B2 * 1/2020 Green H02J 7/0044
 D878,338 S * 3/2020 Yang D14/223
 D881,810 S * 4/2020 Zhang D13/108
 D881,850 S * 4/2020 Zhang D14/223
 D883,259 S * 5/2020 Ma D14/206
 D886,455 S * 6/2020 Williamson D3/294
 D887,351 S * 6/2020 Bonahoom D13/108
 D888,664 S * 6/2020 Ma D13/108
 10,701,472 B1 * 6/2020 Xu H02J 7/0044
 D890,137 S * 7/2020 Ma D14/223
 D890,725 S * 7/2020 Liu D14/223
 D891,434 S * 7/2020 Lee D14/440
 D897,664 S * 10/2020 Li D3/273
 D899,406 S * 10/2020 Ma D14/223
 D902,589 S * 11/2020 Li D3/294
 D904,025 S * 12/2020 Ma D3/294
 D904,761 S * 12/2020 Koneru D3/274
 D904,762 S * 12/2020 Koneru D3/274
 D904,763 S * 12/2020 Koneru D3/274
 D904,764 S * 12/2020 Koneru D3/294
 D904,901 S * 12/2020 Koneru D9/721
 D905,002 S * 12/2020 Koneru D3/319
 D908,084 S * 1/2021 He D3/294
 D911,945 S * 3/2021 Xian D14/223
 D912,015 S * 3/2021 Xie D14/223
 D913,223 S * 3/2021 Li D3/294
 D919,294 S * 5/2021 Fang D3/294
 D920,959 S * 6/2021 Cai D14/223
 D926,731 S * 8/2021 Deng D14/223
 D928,123 S * 8/2021 Gao D14/223
 D946,895 S * 3/2022 Xie D3/294
 D947,532 S * 4/2022 Silva D3/294
 D952,343 S * 5/2022 Liang D3/301
 D953,982 S * 6/2022 Yi D13/108
 D959,830 S * 8/2022 Sun D3/274
 D962,898 S * 9/2022 Deng D14/223
 D965,567 S * 10/2022 Li D14/223
 D965,973 S * 10/2022 Sun D3/274
 D971,886 S * 12/2022 Lorsold D14/223
 2018/0123367 A1 * 5/2018 Higgins H01R 13/2414
 2019/0069066 A1 * 2/2019 Song E05C 19/16
 2020/0216228 A1 * 7/2020 Wang B65D 25/04
 2020/0412143 A1 * 12/2020 Chang H02J 7/0044
 2023/0028541 A1 * 1/2023 Wang H04R 1/1091

* cited by examiner

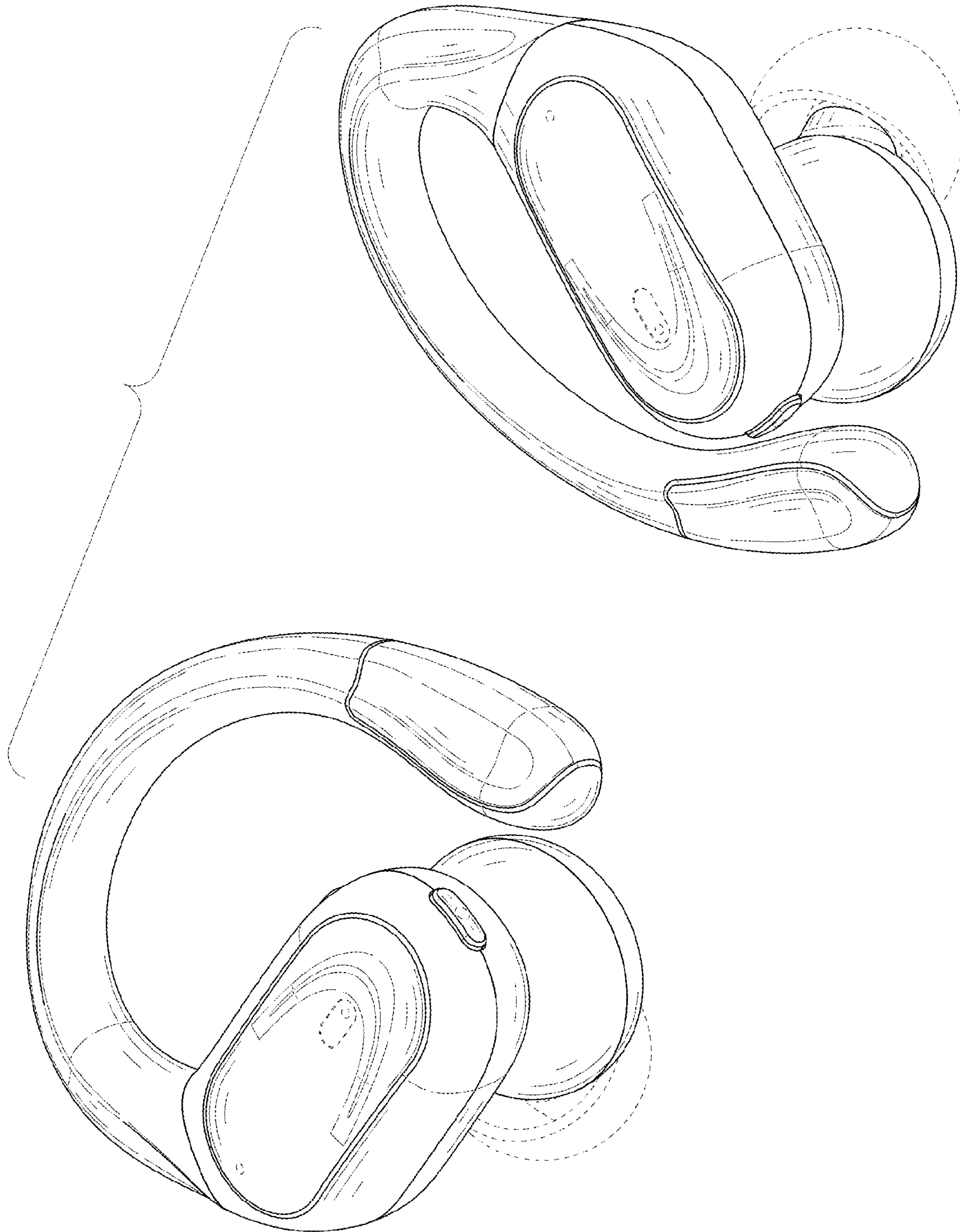

FIG. 1

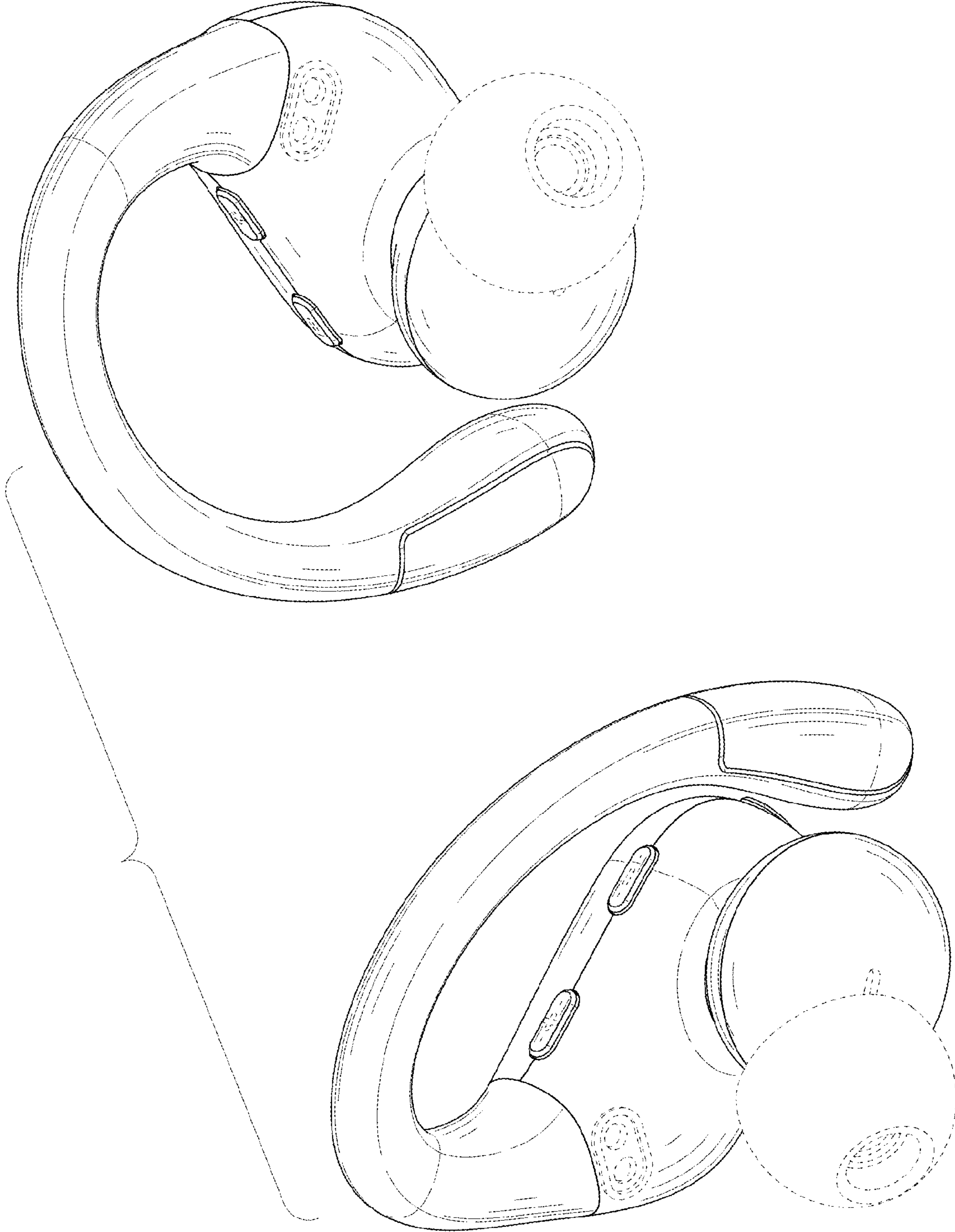

FIG. 2

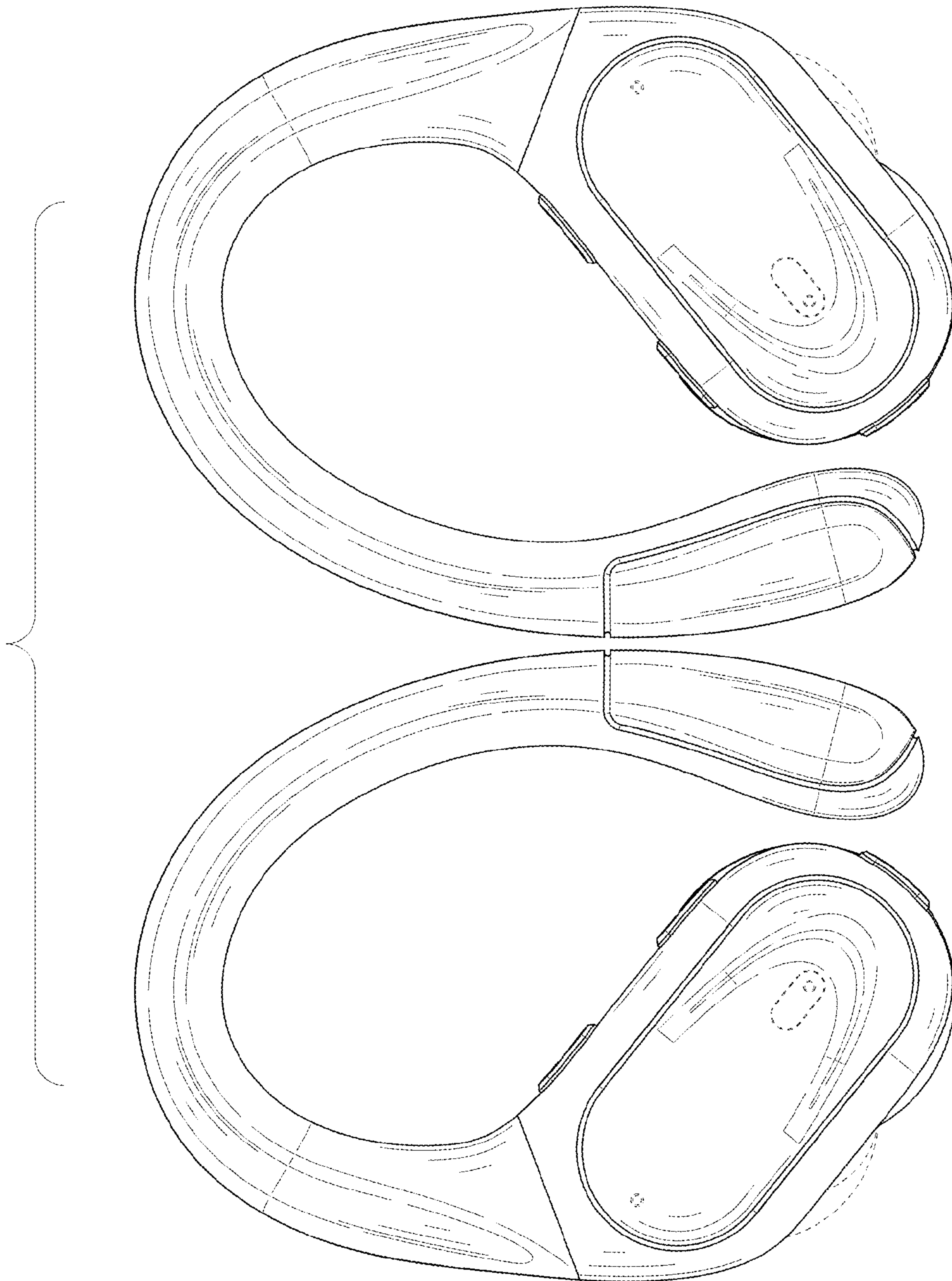

FIG. 3

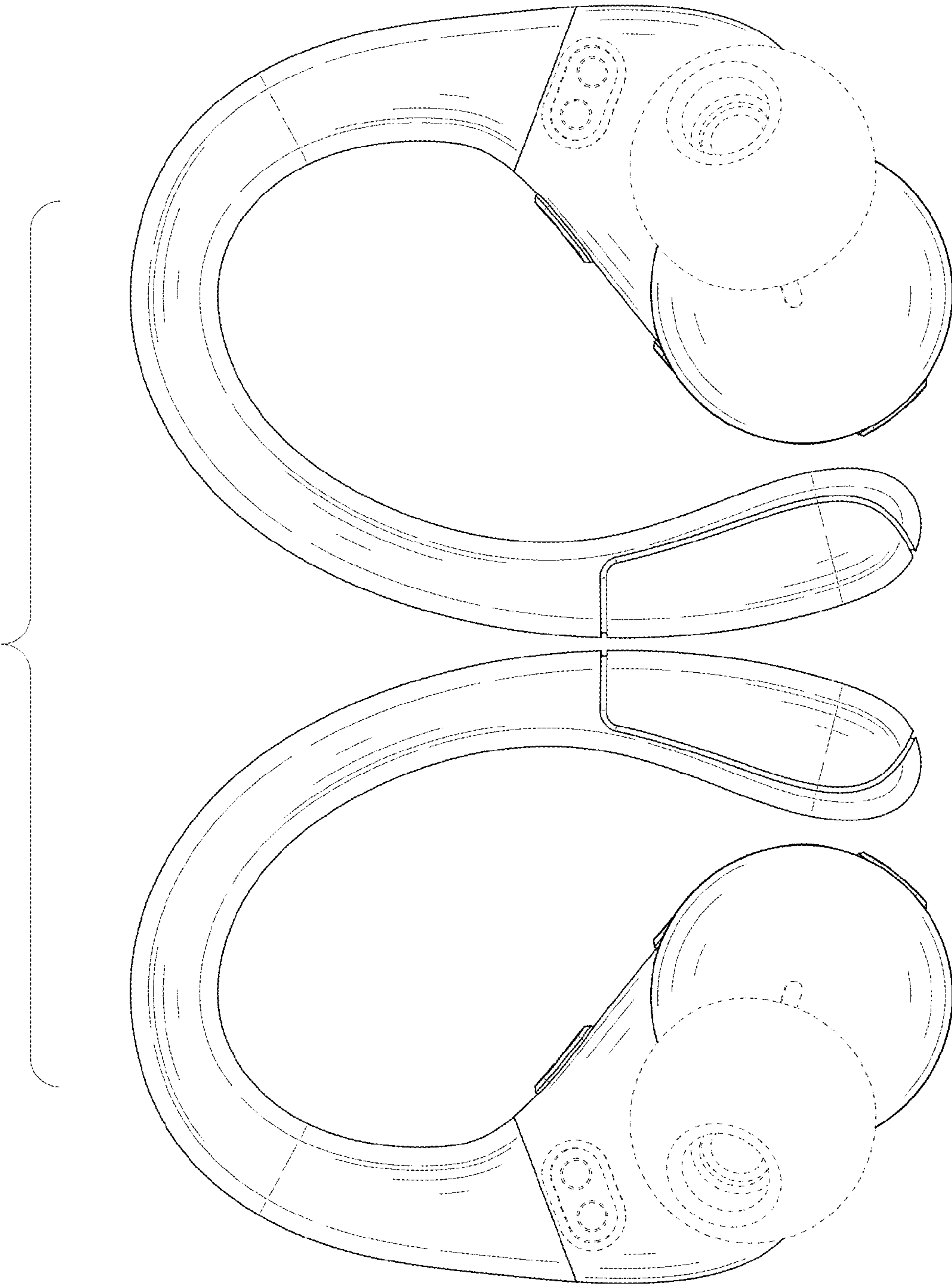

FIG. 4

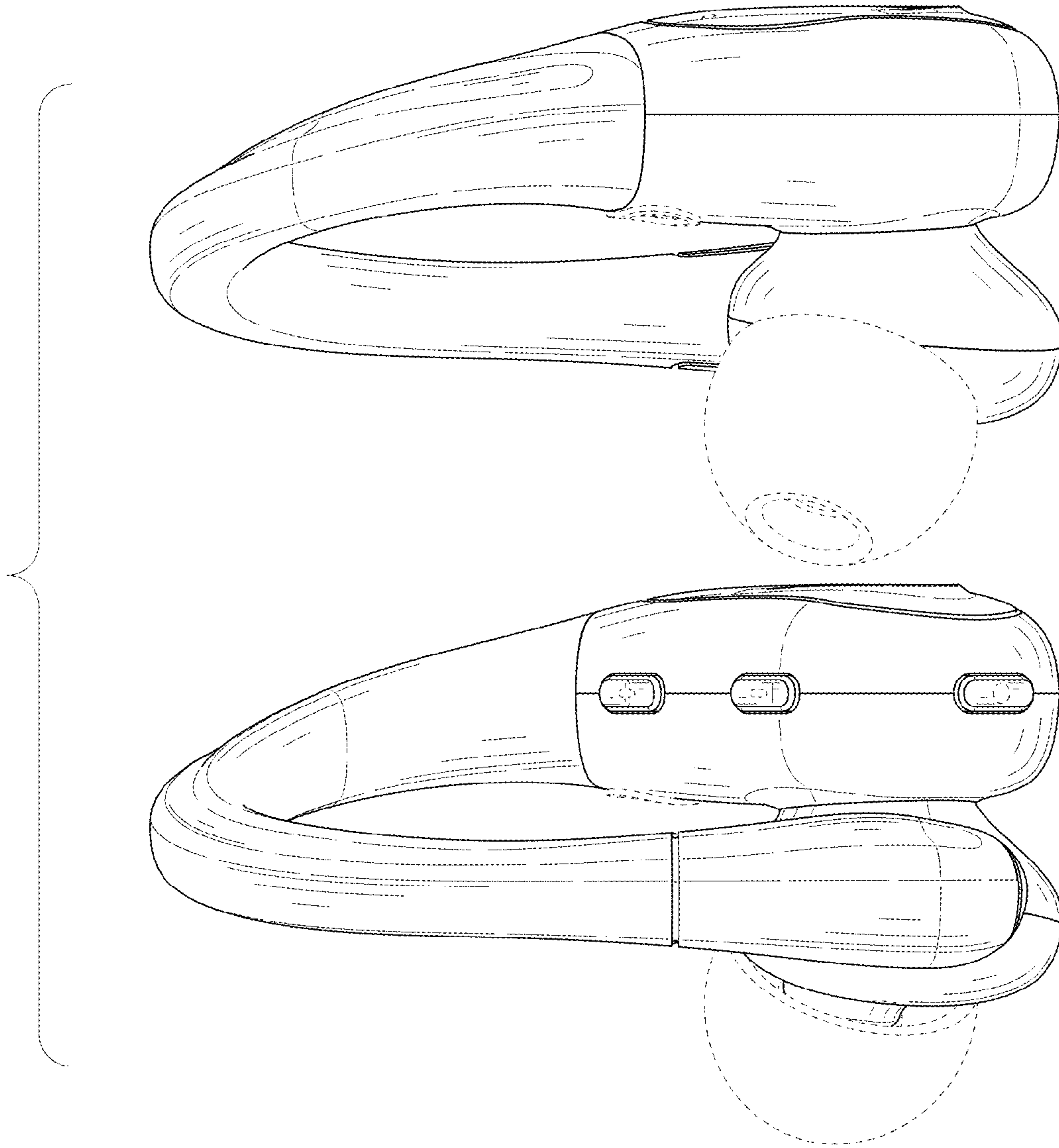

FIG. 5

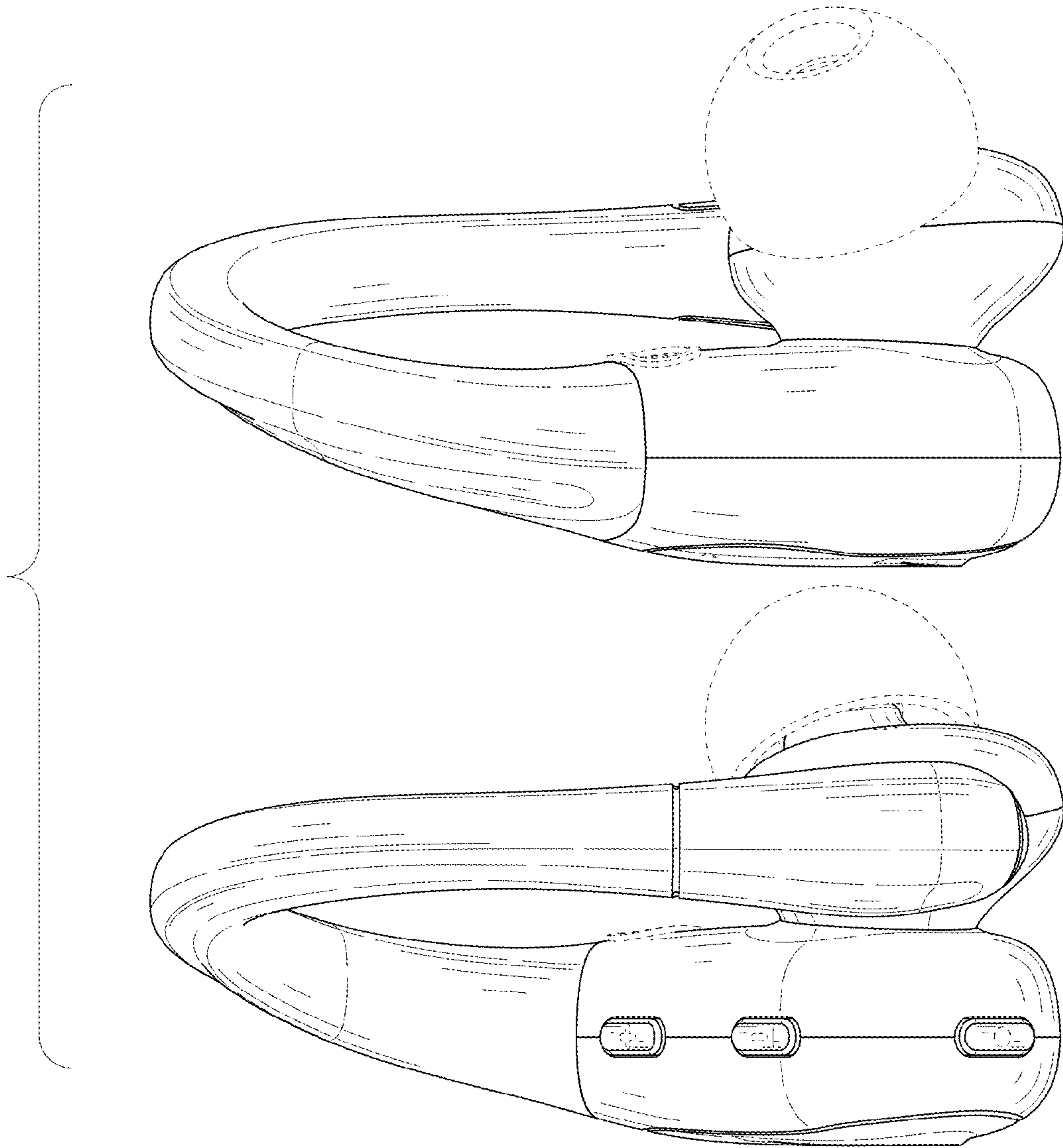

FIG. 6

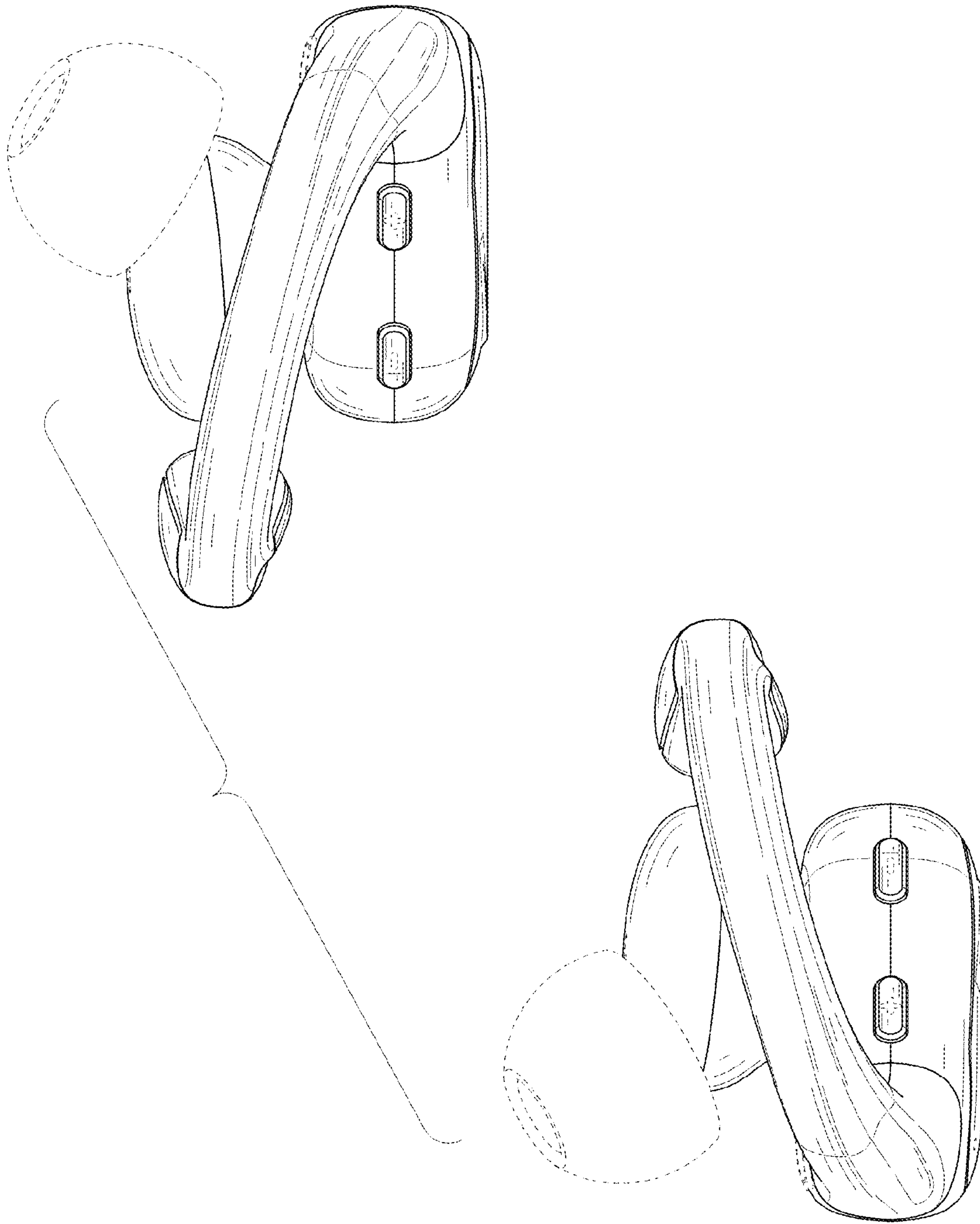

FIG. 7

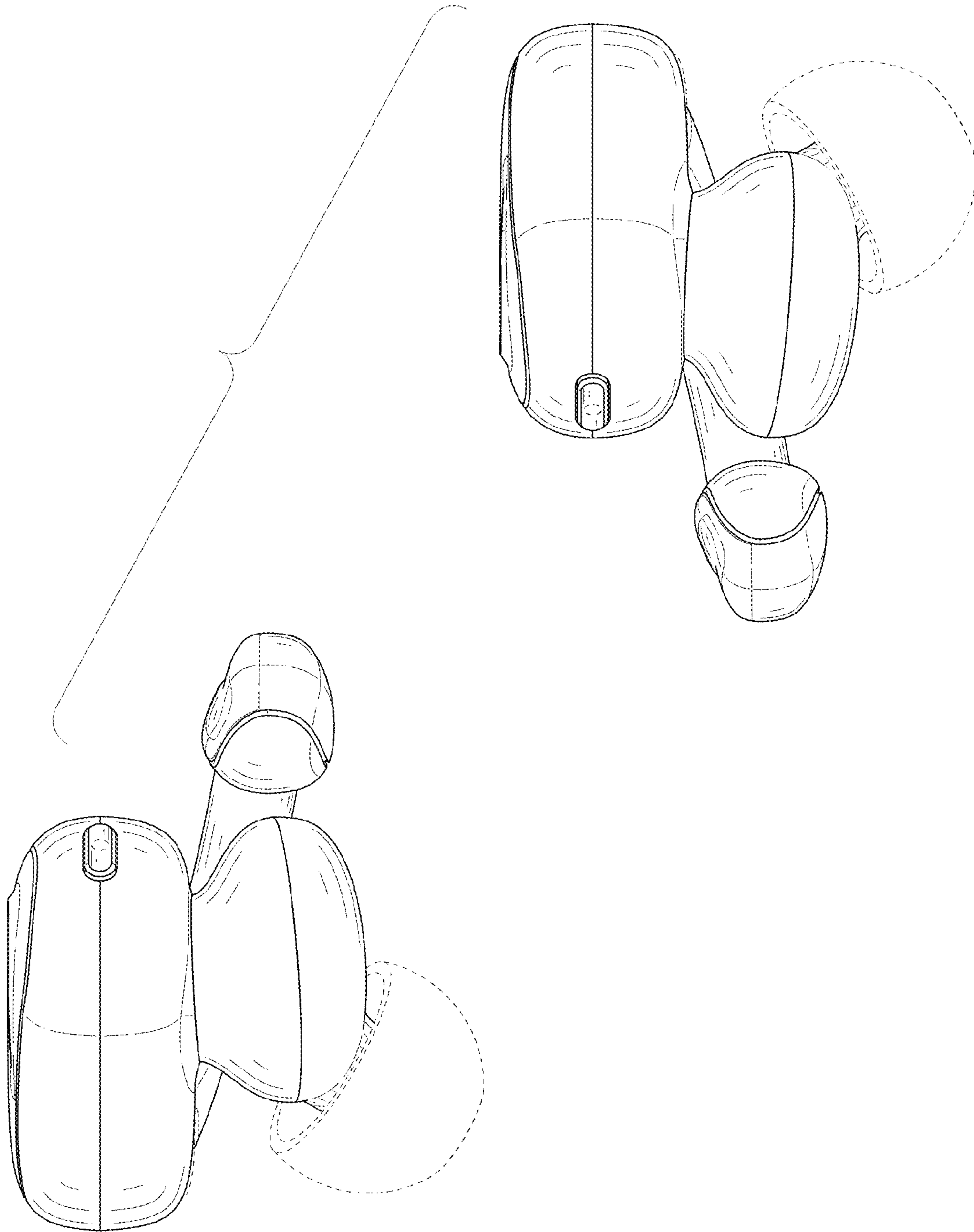

FIG. 8

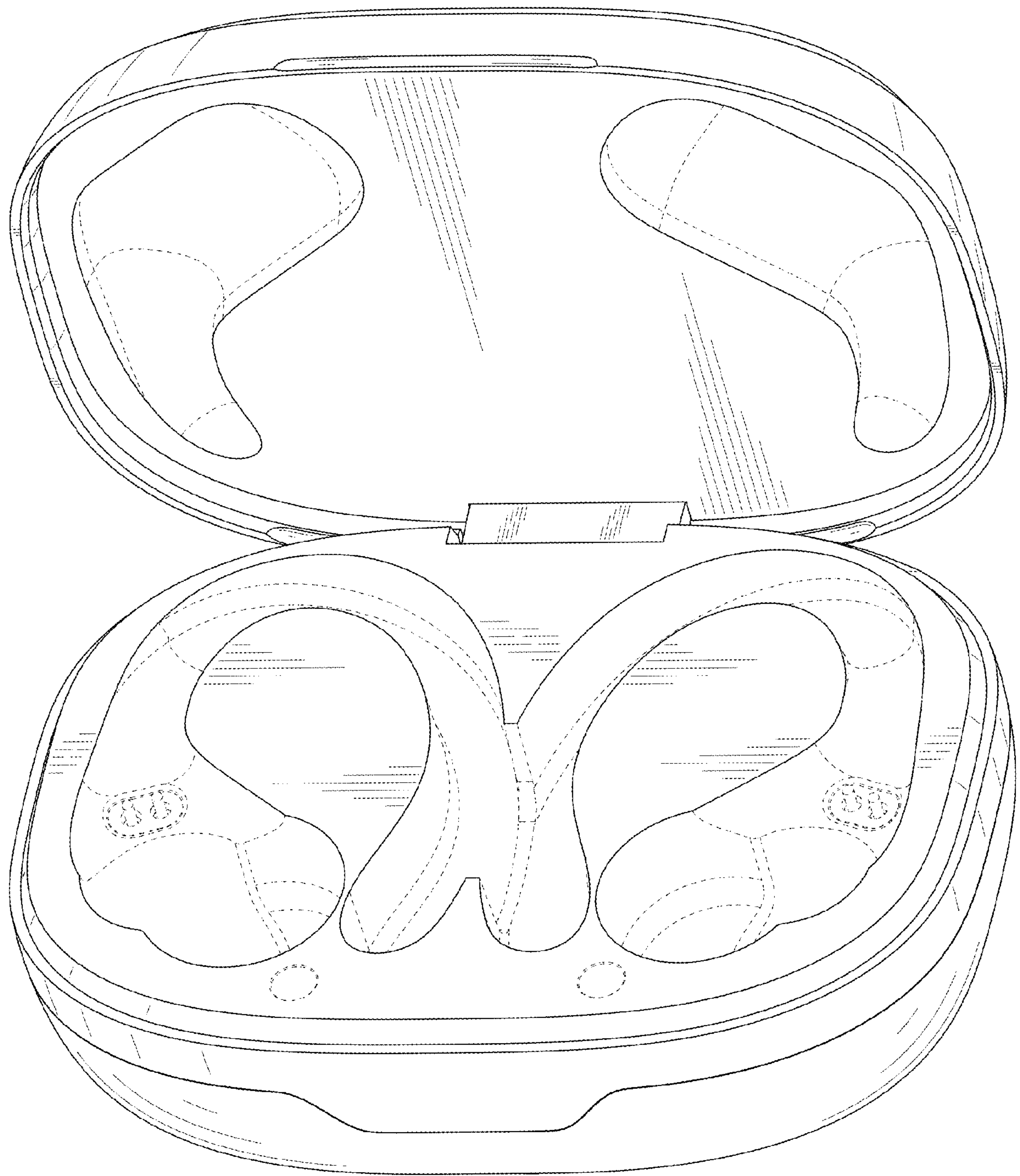

FIG. 9

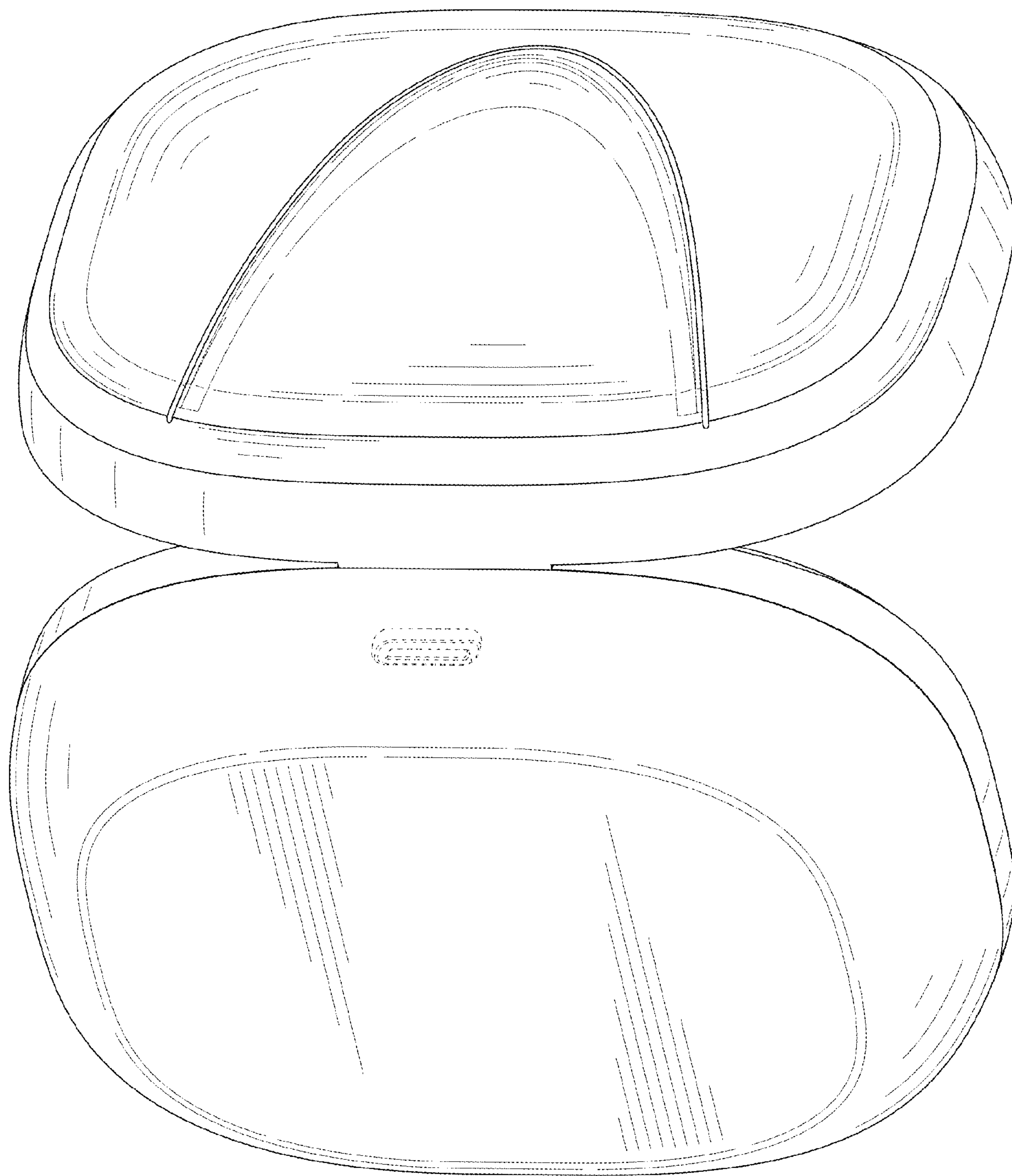

FIG. 10

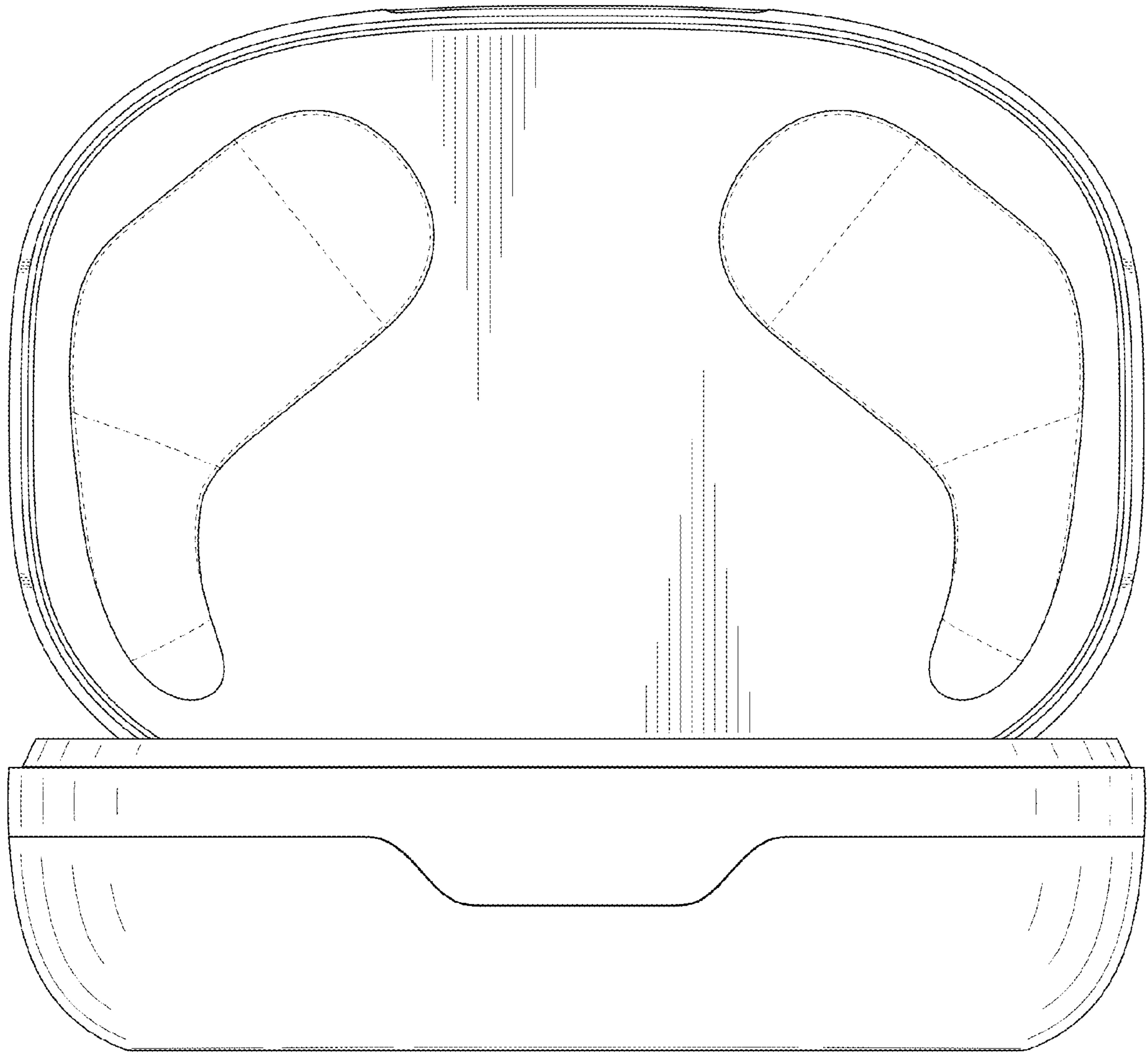

FIG. 11

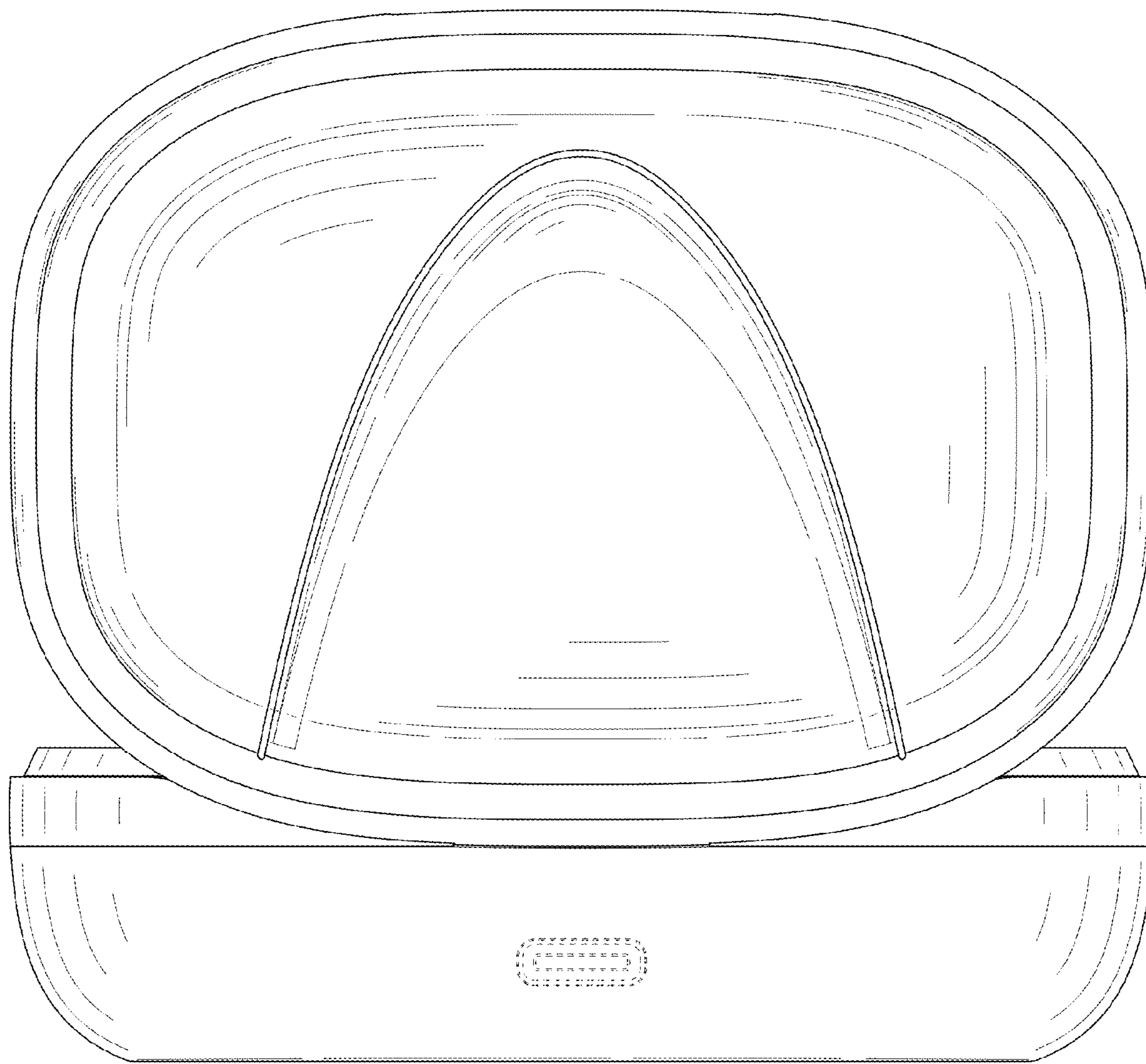

FIG. 12

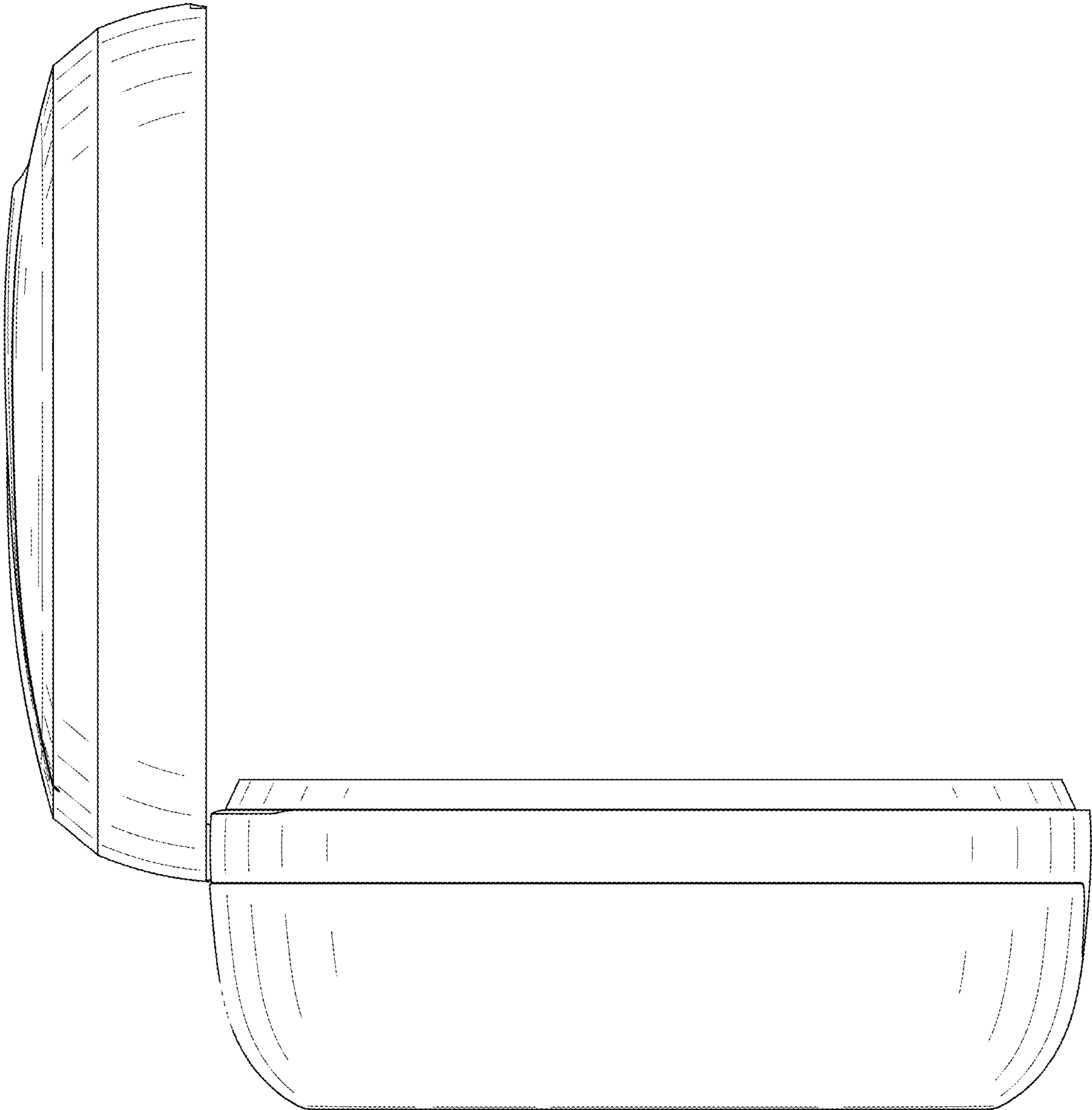

FIG. 13

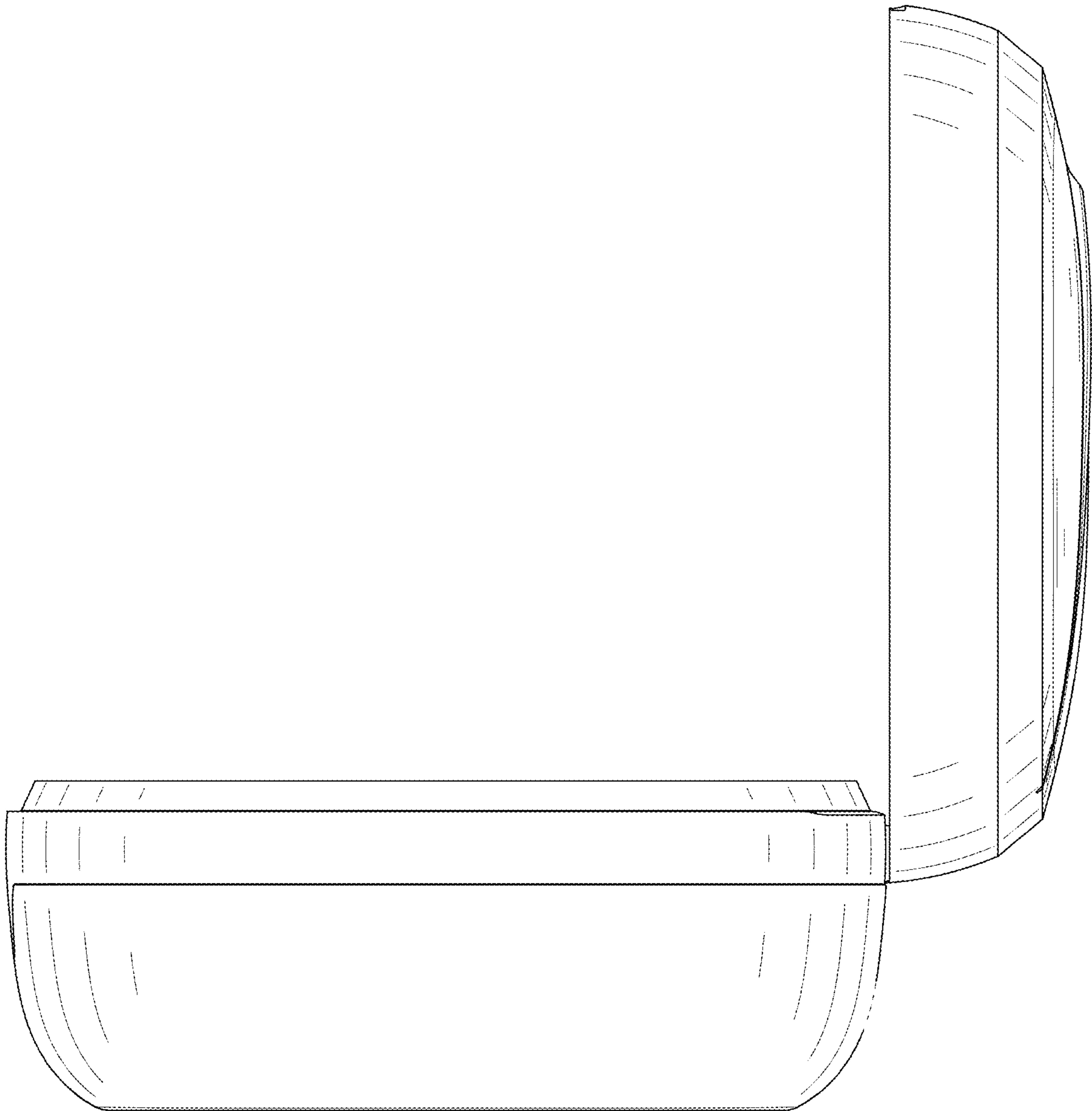

FIG. 14

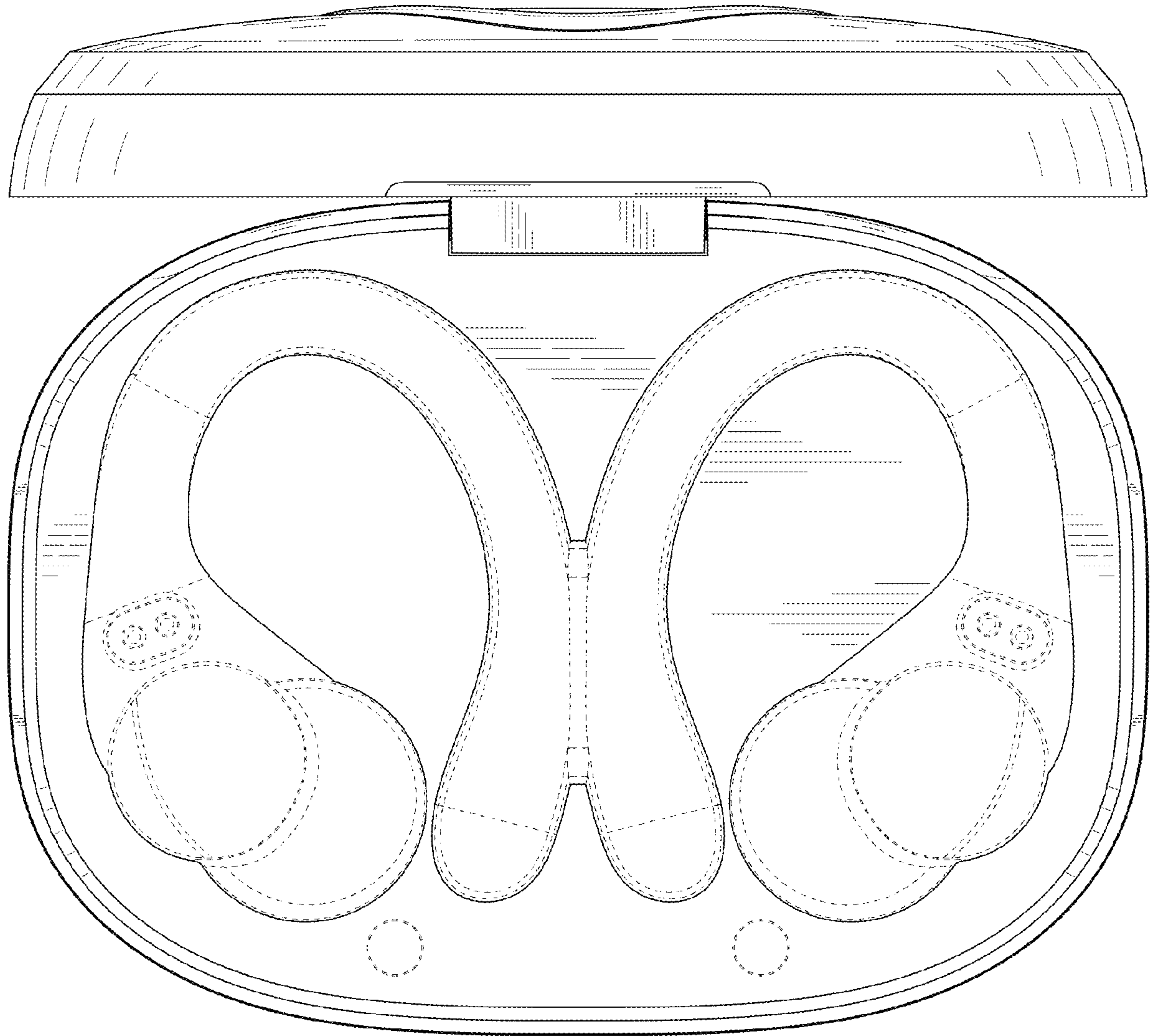

FIG. 15

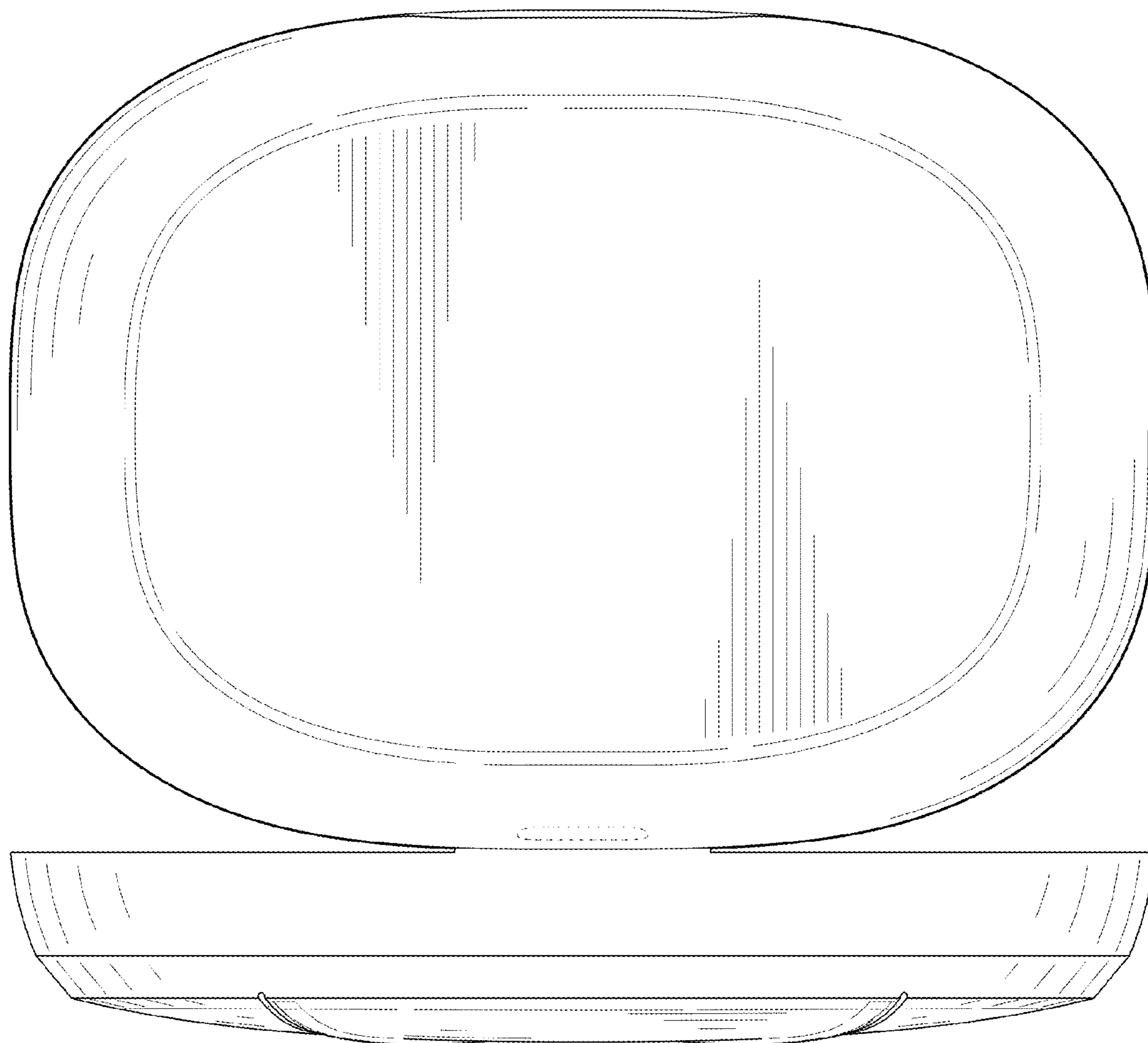

FIG. 16

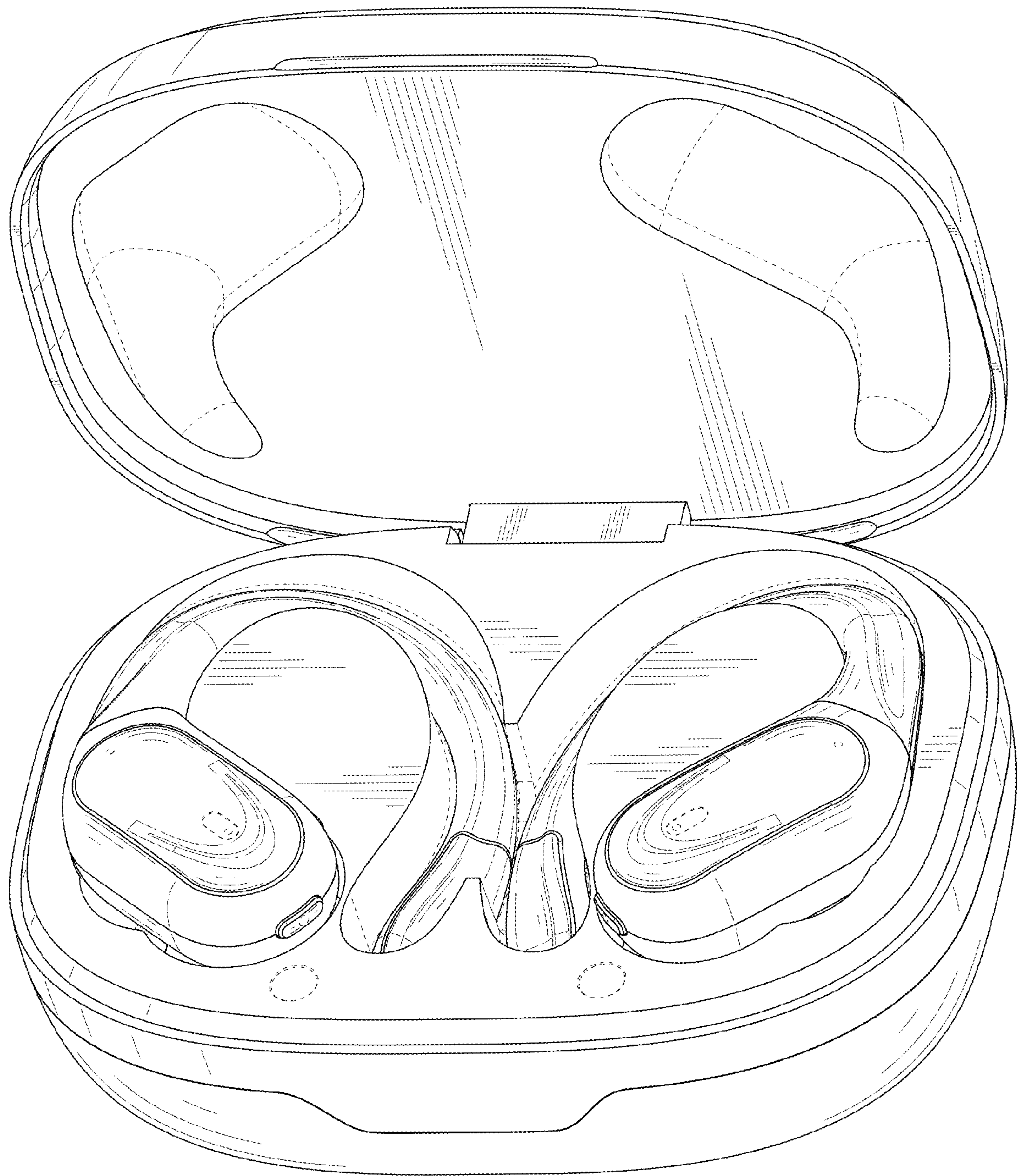

FIG. 17

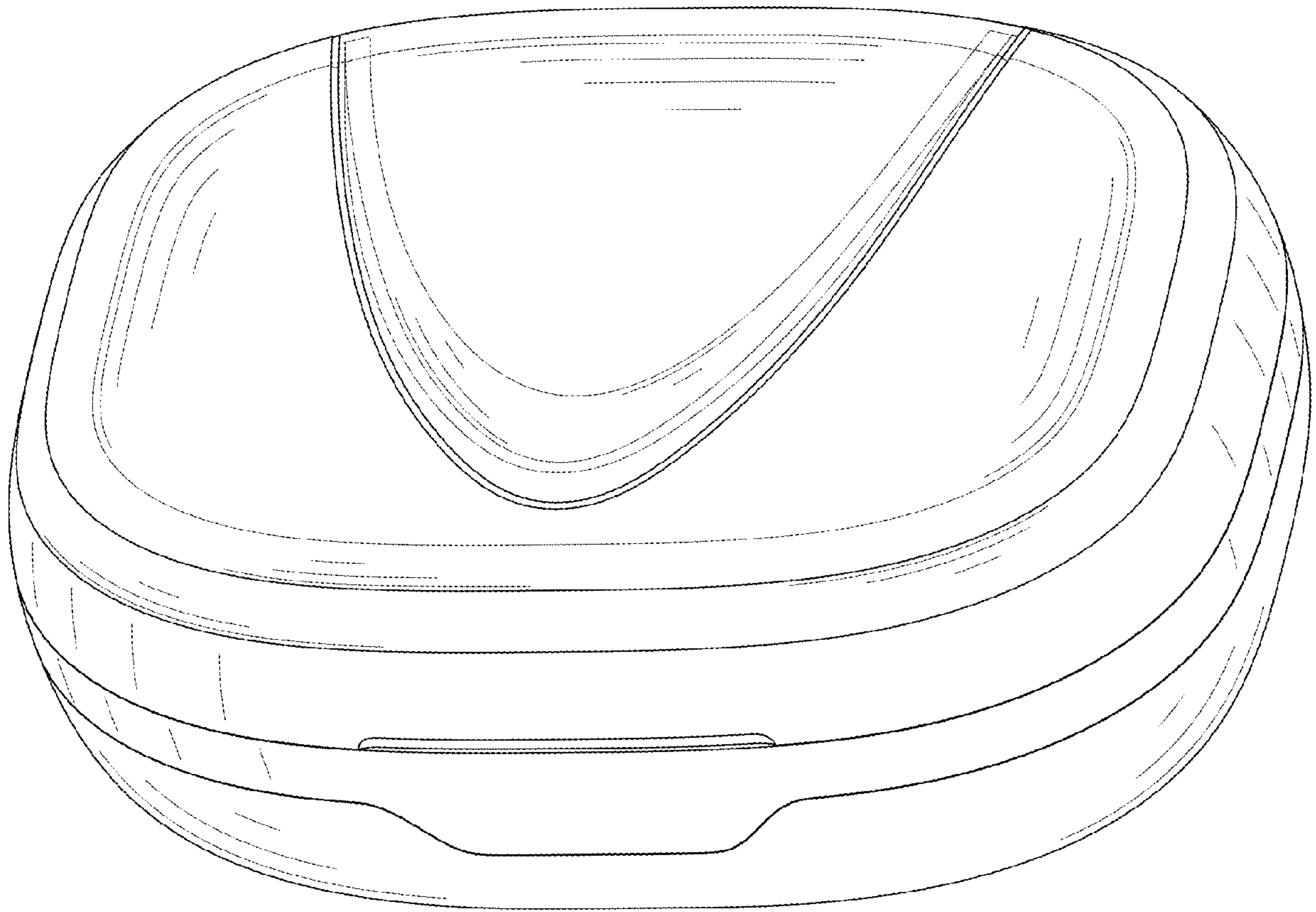

FIG. 18