



US00D984402S

(12) **United States Design Patent** (10) **Patent No.:** **US D984,402 S**
Lee et al. (45) **Date of Patent:** **** Apr. 25, 2023**

(54) **ELECTRONIC DEVICE**

- (71) Applicant: **Samsung Electronics Co., Ltd.**, Suwon-si (KR)
- (72) Inventors: **Jinho Lee**, Suwon-si (KR); **Junwon Lee**, Suwon-si (KR); **Namsu Kim**, Suwon-si (KR); **Kangmoon Kim**, Suwon-si (KR); **Dahyun Lee**, Suwon-si (KR); **Jieun Myung**, Suwon-si (KR); **Junho Jin**, Suwon-si (KR); **Jiyun Lim**, Suwon-si (KR); **Bosoon Kang**, Suwon-si (KR)
- (73) Assignee: **SAMSUNG ELECTRONICS CO., LTD.**, Suwon-si (KR)
- (**) Term: **15 Years**
- (21) Appl. No.: **29/812,270**
- (22) Filed: **Oct. 20, 2021**

(30) **Foreign Application Priority Data**

Apr. 29, 2021 (KR) 30-2021-0020864

(51) **LOC (14) Cl.** **14-03**

(52) **U.S. Cl.**
USPC **D14/138 AB**

(58) **Field of Classification Search**
USPC D14/138 G, 138 AD, 138 AB, 248, 341, D14/345, 439, 432, 371, 374, 138 R, D14/138 AA, 138 AC, 138 C
CPC H04M 1/0202; H04M 1/0235; H04M 1/0237; H04M 1/0239; H04M 1/0266; H04M 1/0268; H04M 1/027; H04M 1/0295; H04M 1/02; H04M 1/0279; H04M 1/0283

See application file for complete search history.

(56) **References Cited**

U.S. PATENT DOCUMENTS

- D544,852 S * 6/2007 Takamori D14/138 AA
- D578,983 S * 10/2008 Bang D14/138 G
- D824,874 S * 8/2018 You D14/138 G
- D825,518 S * 8/2018 Kikuchi D14/345

(Continued)

FOREIGN PATENT DOCUMENTS

- CN 305939035 * 7/2020
- CN 305947954 * 7/2020

(Continued)

OTHER PUBLICATIONS

Samsung Galaxy Z Flip4, announced Aug. 10, 2022, [online], [retrieved on Feb. 16, 2023]. Retrieved from Internet ,<URL: <http://www.gsmarena.com>>.*

(Continued)

Primary Examiner — Bridget L Eland

(74) *Attorney, Agent, or Firm* — McAndrews Held & Malloy, Ltd.

(57) **CLAIM**

The ornamental design for an electronic device, as shown and described.

DESCRIPTION

FIG. 1 is a front perspective view of an electronic device showing our new design;
FIG. 2 is a front view thereof;
FIG. 3 is a rear view thereof;
FIG. 4 is a left side view thereof;
FIG. 5 is a right side view thereof;
FIG. 6 is a top plan view thereof;
FIG. 7 is a bottom plan view thereof; and,
FIG. 8 is a rear perspective view thereof.

The dashed broken lines in the figures depict portions of the electronic device that form no part of the claimed design.

1 Claim, 6 Drawing Sheets

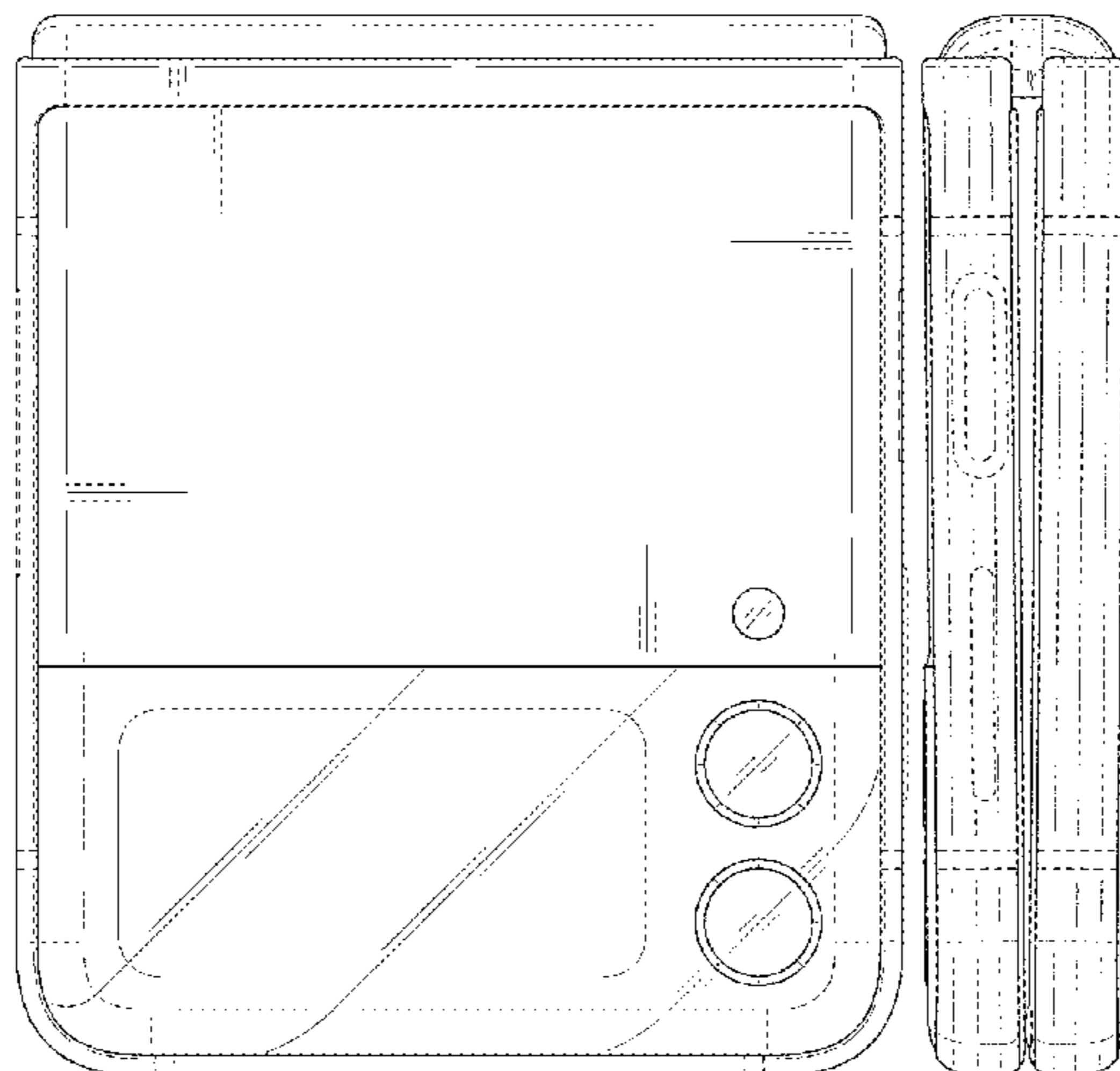

(56)

References Cited

FOREIGN PATENT DOCUMENTS

U.S. PATENT DOCUMENTS

D898,693 S * 10/2020 Lee D14/138 AB
 D902,167 S * 11/2020 Lee D14/138 AB
 D902,901 S * 11/2020 Kim D14/248
 D902,902 S * 11/2020 Kim D14/248
 D902,903 S * 11/2020 Kim D14/248
 D905,670 S * 12/2020 Seo D14/248
 D926,150 S * 7/2021 Xie D14/138 AB
 D953,282 S * 5/2022 Song D14/138 AB
 D954,014 S * 6/2022 Song D14/138 AB
 D957,376 S * 7/2022 Song D14/248
 D957,378 S * 7/2022 Seo D14/248
 D957,382 S * 7/2022 Song D14/248
 11,385,687 B1 * 7/2022 Kim G06F 1/1652
 D962,189 S * 8/2022 Song D14/138 AB
 D962,916 S * 9/2022 Seo D14/248
 D964,306 S * 9/2022 Gong D14/138 AB
 D964,956 S * 9/2022 Gong D14/138 AB
 D965,545 S * 10/2022 Song D14/138 AB
 D965,547 S * 10/2022 Song D14/138 AB
 11,528,352 B1 * 12/2022 Lim G06F 1/1681
 2014/0111954 A1 * 4/2014 Lee H04M 1/0268
 361/749
 2023/0029701 A1 * 2/2023 Lee H04M 1/0268

CN 306118554 * 10/2020
 IN 373340-001-0001 * 1/2023
 IN 373341-001-0001 * 1/2023
 WO D216764-001 * 10/2021
 WO D216764-002 * 10/2021
 WO D216764-003 * 10/2021
 WO D216764-004 * 10/2021
 WO D216764-005 * 10/2021
 WO D216764-006 * 10/2021
 WO D224129-001 * 10/2022
 WO D224129-002 * 10/2022
 WO D224129-003 * 10/2022

OTHER PUBLICATIONS

Samsung Galaxy Z Flip3 5G, announced Aug. 11, 2021, [online],
 [retrieved on Feb. 16, 2023]. Retrieved from Internet ,<URL:
<http://www.gsmarena.com>>.*

* cited by examiner

FIG. 1

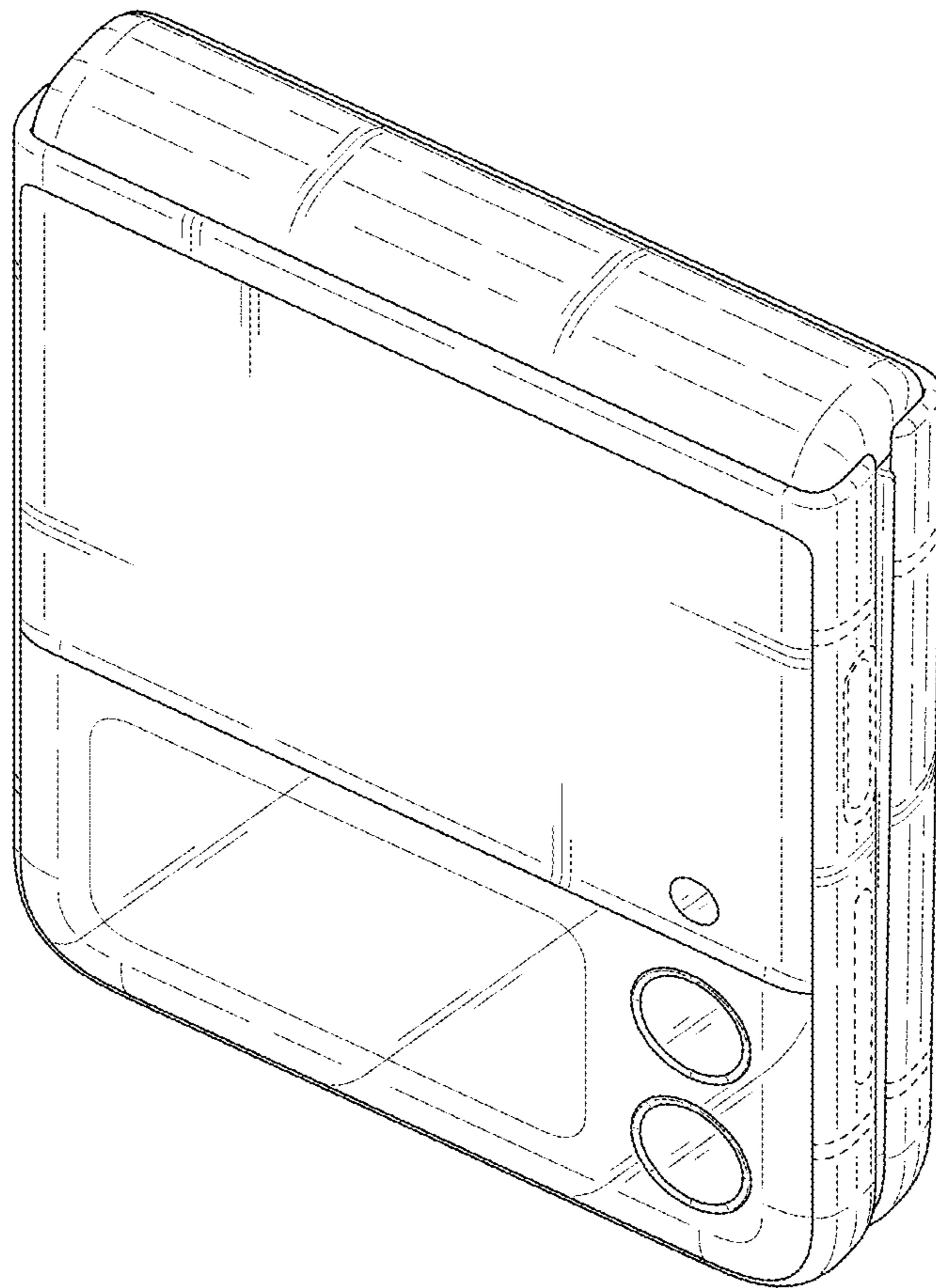

FIG. 2

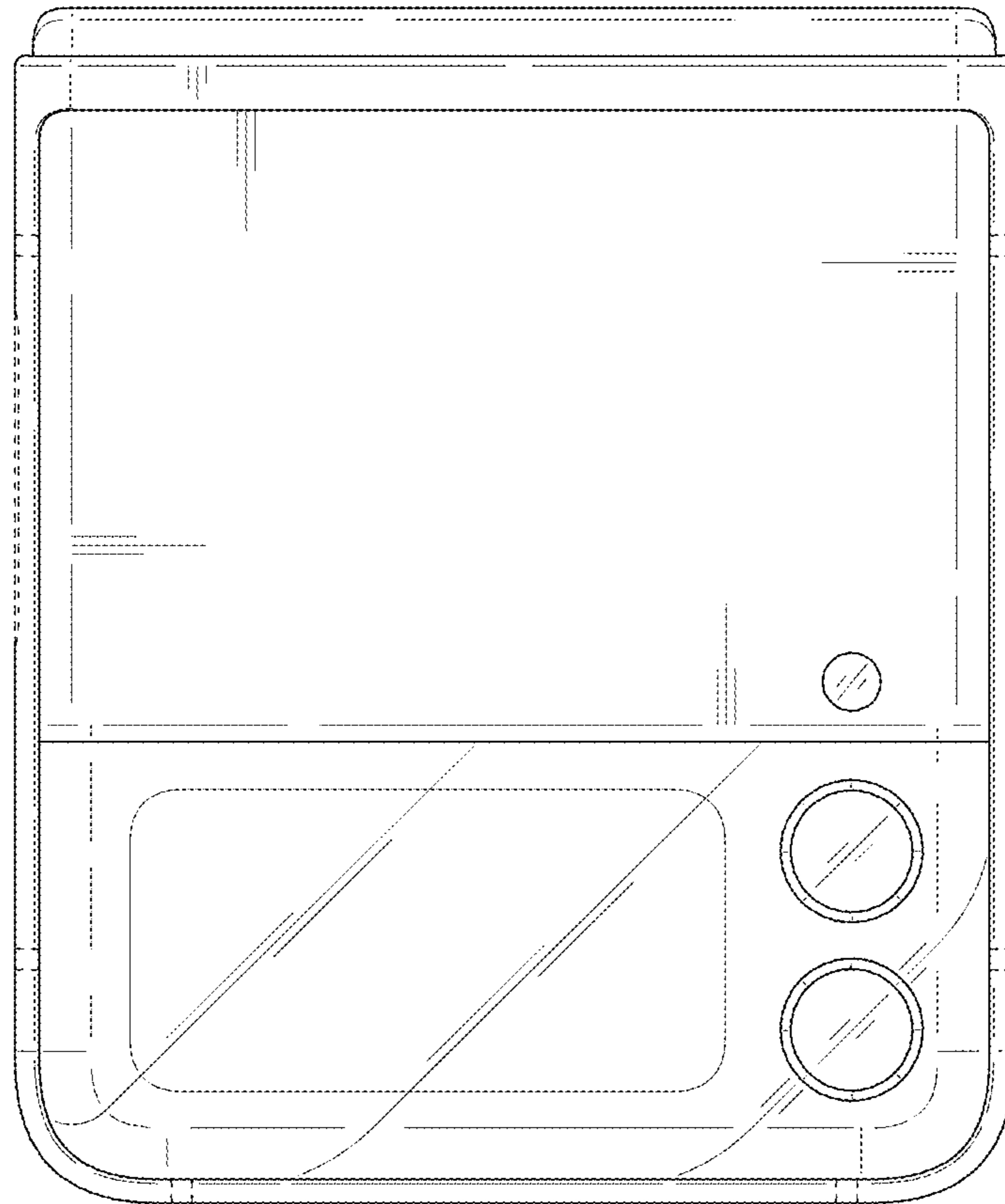

FIG. 3

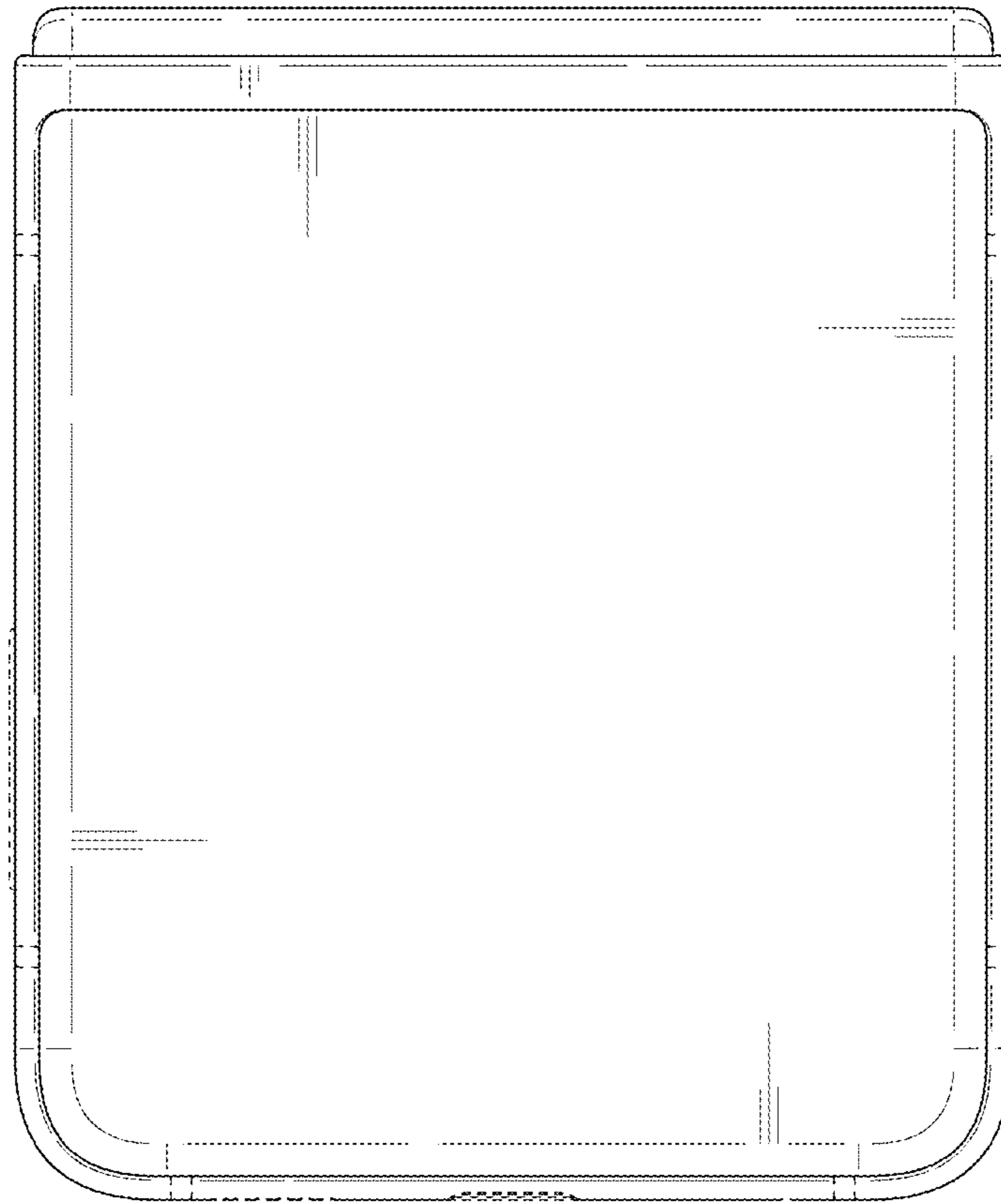

FIG. 4

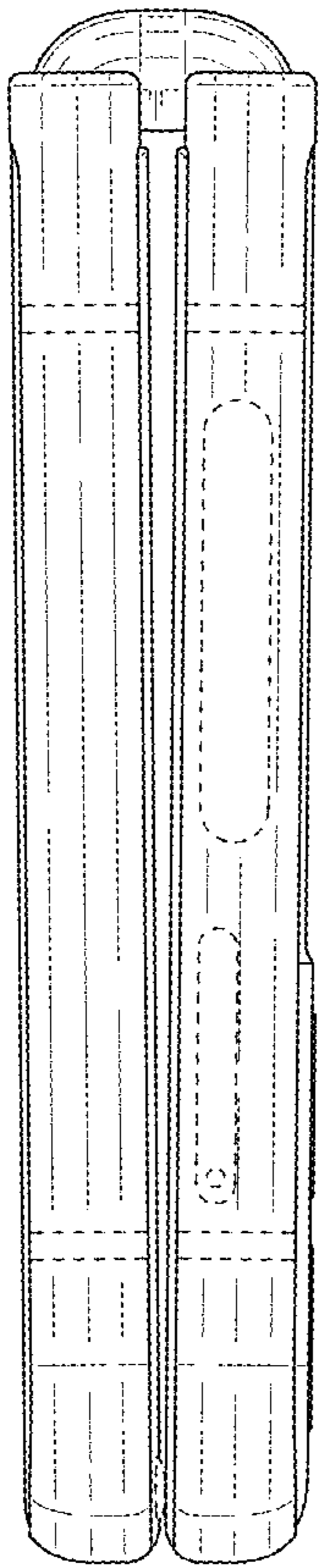

FIG. 5

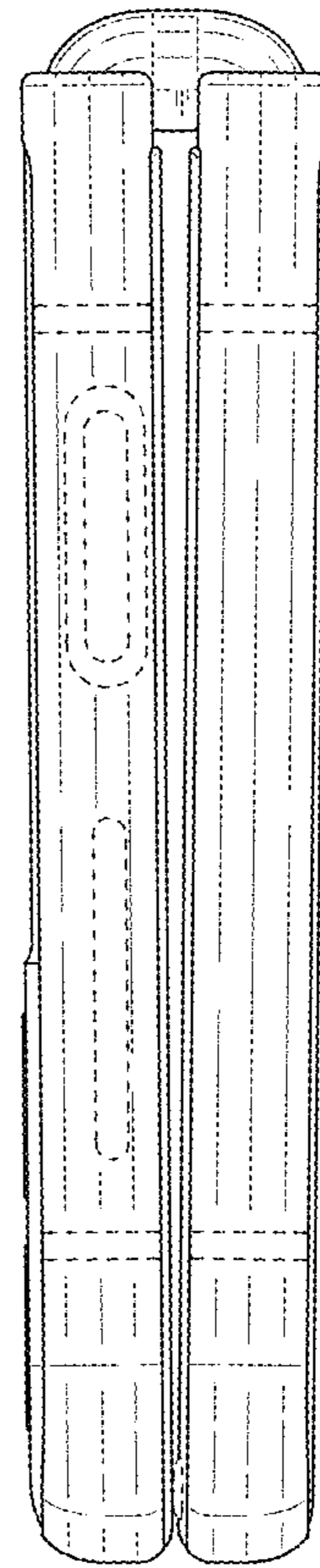

FIG. 6

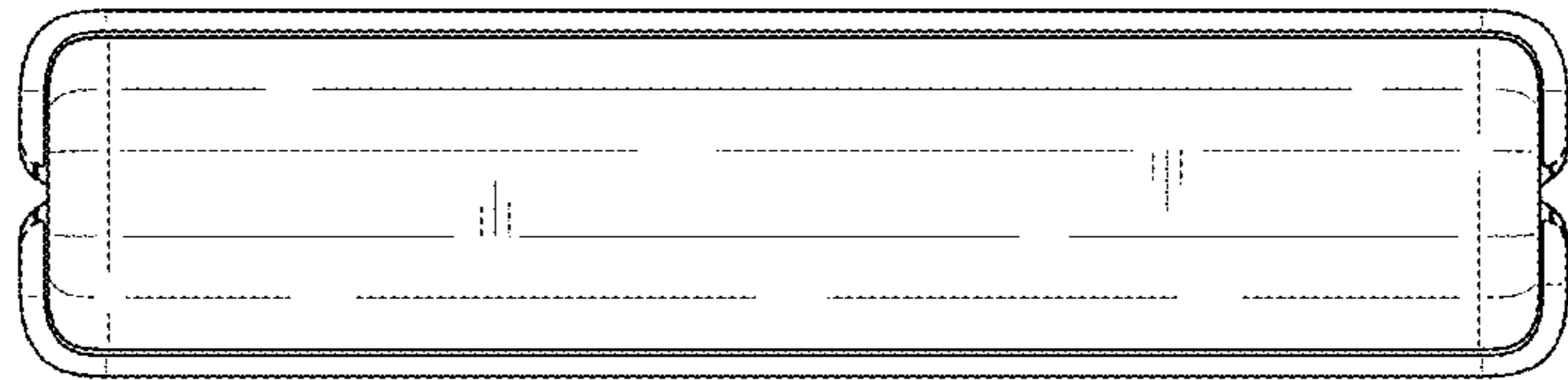

FIG. 7

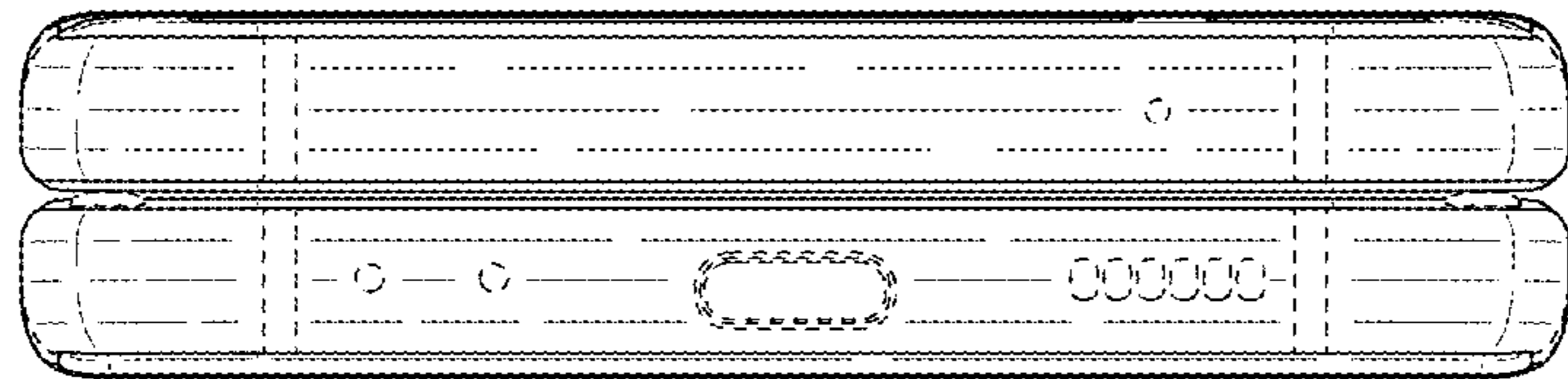

FIG. 8

