



US00D984401S

(12) **United States Design Patent** (10) **Patent No.:** **US D984,401 S**  
**Lee et al.** (45) **Date of Patent:** **\*\* Apr. 25, 2023**

(54) **ELECTRONIC DEVICE**

FOREIGN PATENT DOCUMENTS

(71) Applicant: **Samsung Electronics Co., Ltd.**,  
Suwon-si (KR)

CN 305939035 \* 7/2020  
CN 305947954 \* 7/2020

(Continued)

(72) Inventors: **Jinhoo Lee**, Suwon-si (KR); **Junwon Lee**, Suwon-si (KR); **Namsu Kim**, Suwon-si (KR); **Kangmoon Kim**, Suwon-si (KR); **Dahyun Lee**, Suwon-si (KR); **Jieun Myung**, Suwon-si (KR); **Junho Jin**, Suwon-si (KR); **Jiyun Lim**, Suwon-si (KR); **Bosoon Kang**, Suwon-si (KR)

OTHER PUBLICATIONS

Samsung Galaxy Z Flip4, announced Aug. 10, 2022, [online], [retrieved on Feb. 16, 2023]. Retrieved from Internet ,<URL: <http://www.gsarena.com>>.\*

(Continued)

*Primary Examiner* — Bridget L Eland  
(74) *Attorney, Agent, or Firm* — McAndrews Held & Malloy, Ltd.

(73) Assignee: **SAMSUNG ELECTRONICS CO., LTD.**, Suwon-si (KR)

(57) **CLAIM**

(\*\*) Term: **15 Years**

The ornamental design for an electronic device, as shown and described.

(21) Appl. No.: **29/812,261**

(22) Filed: **Oct. 20, 2021**

**DESCRIPTION**

(30) **Foreign Application Priority Data**

Apr. 29, 2021 (KR) ..... 30-2021-0020867

(51) **LOC (14) Cl.** ..... **14-03**

(52) **U.S. Cl.**  
USPC ..... **D14/138 AB**

(58) **Field of Classification Search**  
USPC ..... D14/138 G, 138 AD, 138 AB, 248, 341, D14/345, 439, 432, 371, 374, 138 R, D14/138 AA, 138 AC, 138 C  
(Continued)

FIG. 1 is a front perspective view of an electronic device showing our new design according to a first embodiment; FIG. 2 is a front view thereof; FIG. 3 is a rear view thereof; FIG. 4 is a left side view thereof; FIG. 5 is a right side view thereof; FIG. 6 is a top plan view thereof; FIG. 7 is a bottom plan view thereof; FIG. 8 is a rear perspective view thereof; FIG. 9 is a front perspective view of an electronic device showing our new design according to a second embodiment; FIG. 10 is a front view thereof; FIG. 11 is a rear view thereof; FIG. 12 is a left side view thereof; FIG. 13 is a right side view thereof; FIG. 14 is a top plan view thereof; FIG. 15 is a bottom plan view thereof; and, FIG. 16 is a rear perspective view thereof.

(Continued)

(56) **References Cited**

U.S. PATENT DOCUMENTS

D544,852 S \* 6/2007 Takamori ..... D14/138 AA  
D578,983 S \* 10/2008 Bang ..... D14/138 G

(Continued)

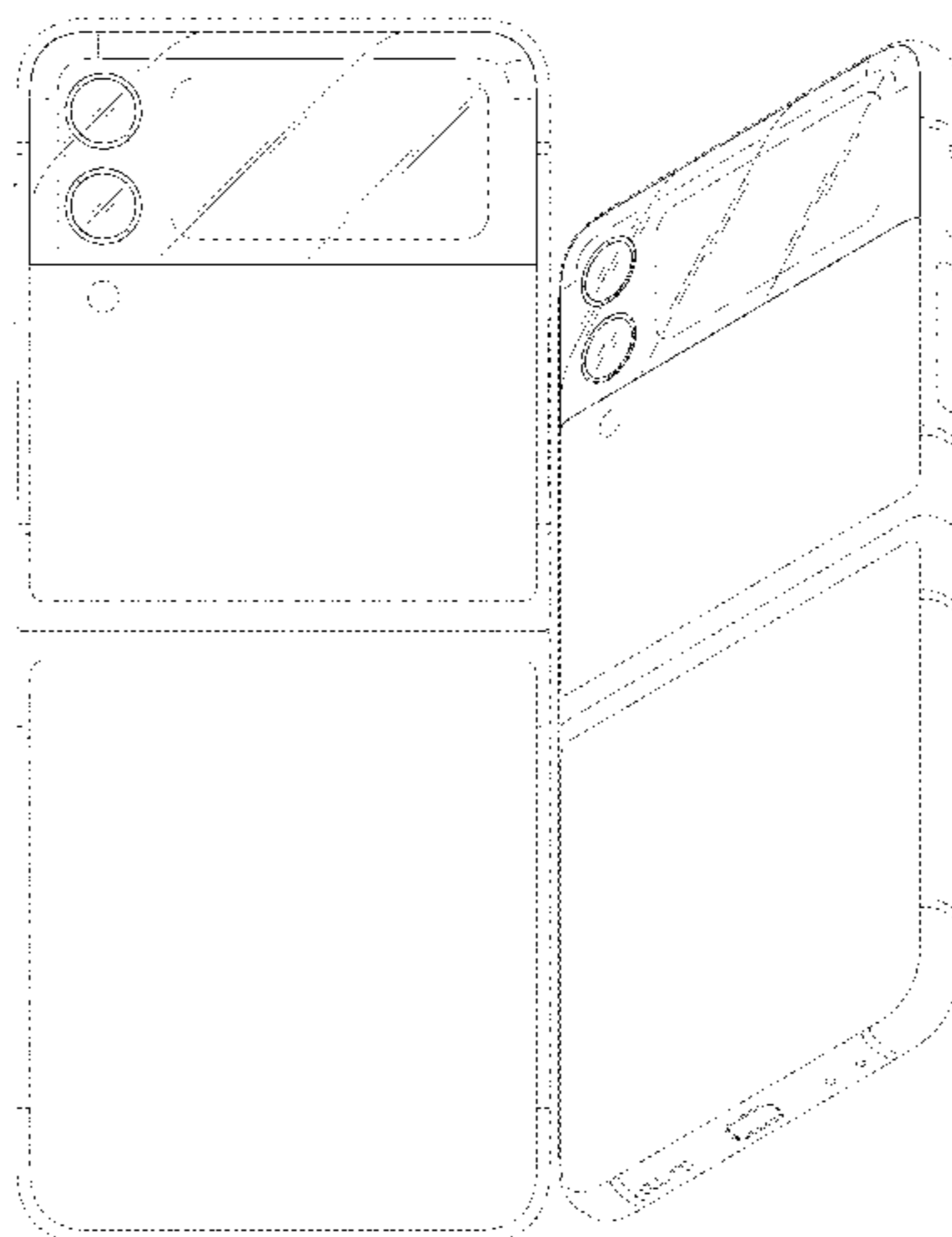

The dashed broken lines in the figures depict portions of the electronic device that form no part of the claimed design.

1 Claim, 12 Drawing Sheets

(58) Field of Classification Search

CPC ..... H04M 1/0202; H04M 1/0235; H04M 1/0237; H04M 1/0239; H04M 1/0266; H04M 1/0268; H04M 1/027; H04M 1/0295; H04M 1/02; H04M 1/0279; H04M 1/0283

See application file for complete search history.

(56) References Cited

U.S. PATENT DOCUMENTS

D824,874 S \* 8/2018 You ..... D14/138 G
D825,518 S \* 8/2018 Kikuchi ..... D14/345
D898,693 S \* 10/2020 Lee ..... D14/138 AB
D902,167 S \* 11/2020 Lee ..... D14/138 AB
D902,901 S \* 11/2020 Kim ..... D14/248
D902,902 S \* 11/2020 Kim ..... D14/248
D902,903 S \* 11/2020 Kim ..... D14/248
D905,670 S \* 12/2020 Seo ..... D14/248
D926,150 S \* 7/2021 Xie ..... D14/138 AB
D953,282 S \* 5/2022 Song ..... D14/138 AB
D954,014 S \* 6/2022 Song ..... D14/138 AB
D957,376 S \* 7/2022 Song ..... D14/248
D957,378 S \* 7/2022 Seo ..... D14/248
D957,382 S \* 7/2022 Song ..... D14/248

11,385,687 B1 \* 7/2022 Kim ..... G06F 1/1652
D962,189 S \* 8/2022 Song ..... D14/138 AB
D962,916 S \* 9/2022 Seo ..... D14/248
D964,306 S \* 9/2022 Gong ..... D14/138 AB
D964,956 S \* 9/2022 Gong ..... D14/138 AB
D965,545 S \* 10/2022 Song ..... D14/138 AB
D965,547 S \* 10/2022 Song ..... D14/138 AB
11,528,352 B1 \* 12/2022 Lim ..... G06F 1/1681
2014/0111954 A1 \* 4/2014 Lee ..... H04M 1/0268
361/749
2023/0029701 A1 \* 2/2023 Lee ..... H04M 1/0268

FOREIGN PATENT DOCUMENTS

CN 306118554 \* 10/2020
IN 373340-001-0001 \* 1/2023
IN 373341-001-0001 \* 1/2023
WO D216764-001 \* 10/2021
WO D216764-002 \* 10/2021
WO D216764-003 \* 10/2021
WO D216764-004 \* 10/2021
WO D216764-005 \* 10/2021
WO D216764-006 \* 10/2021
WO D224129-001 \* 10/2022
WO D224129-002 \* 10/2022
WO D224129-003 \* 10/2022

OTHER PUBLICATIONS

Samsung Galaxy Z Flip3 5G, announced Aug. 11, 2021, [online], [retrieved on Feb. 16, 2023]. Retrieved from Internet ,<URL: http://www.gsmarena.com>.\*

\* cited by examiner

FIG. 1

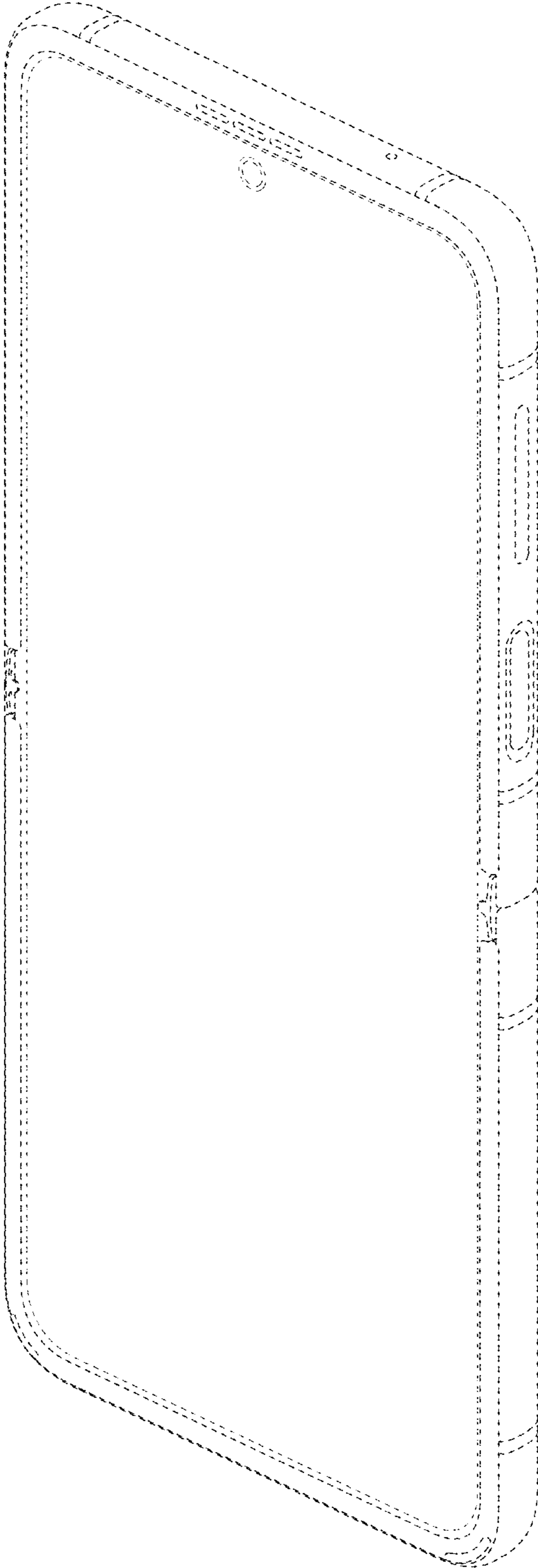

FIG. 2

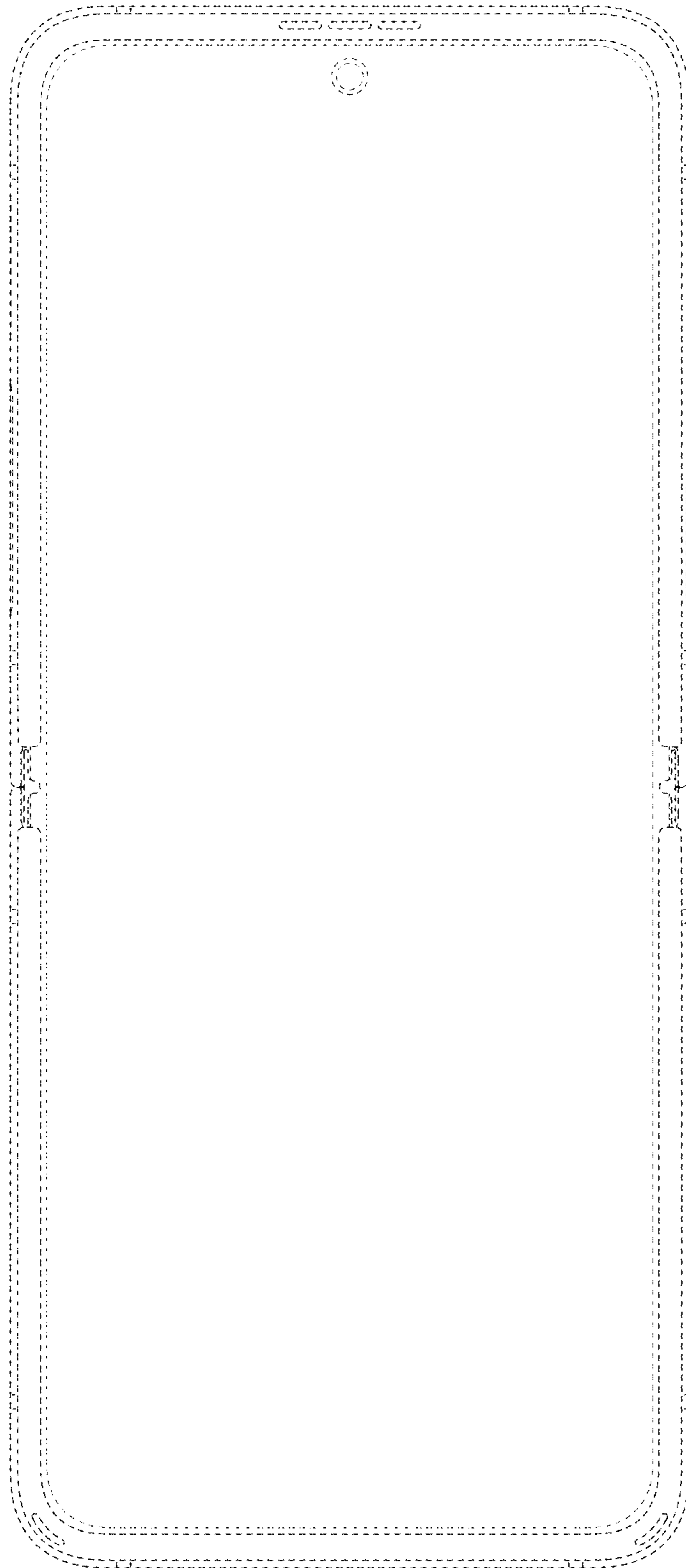

FIG. 3

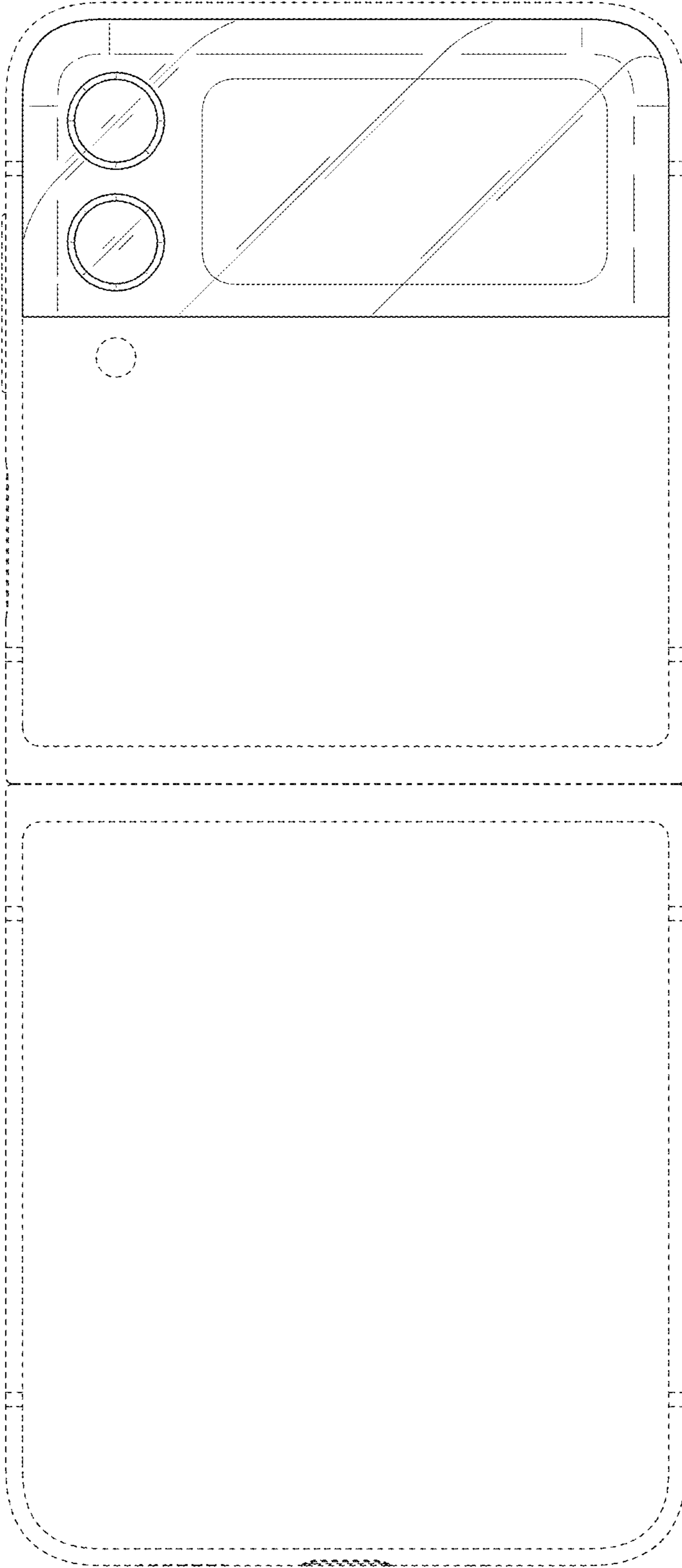

FIG. 4

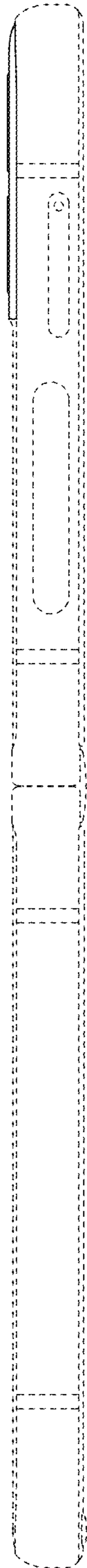

FIG. 5

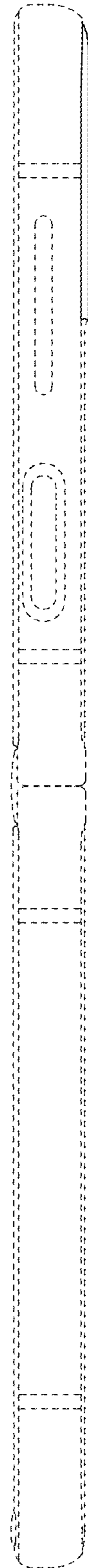



FIG. 6

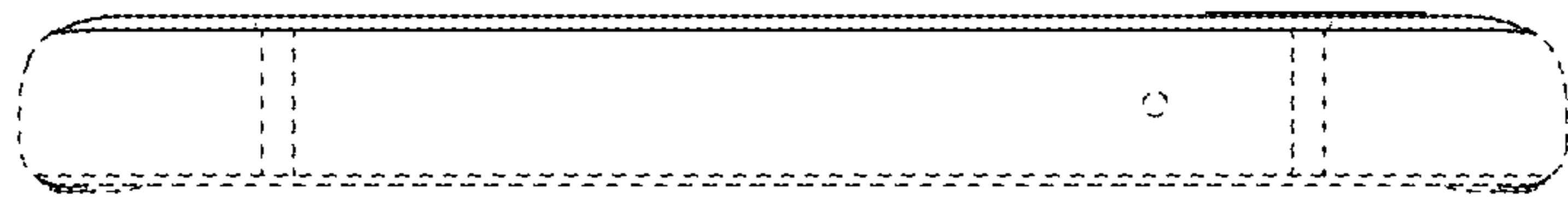

FIG. 7

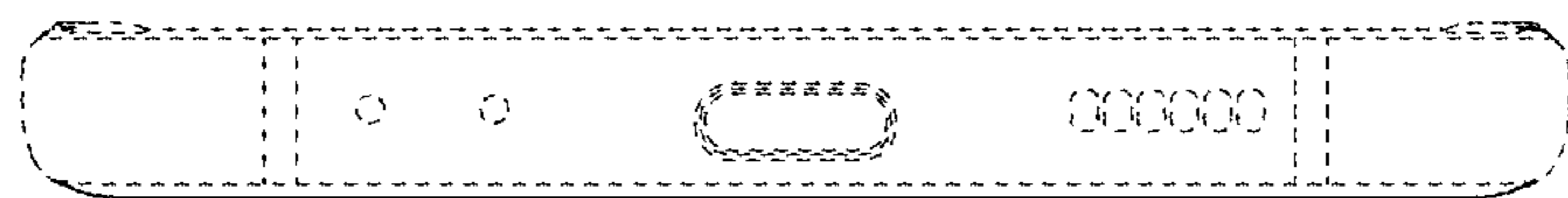

FIG. 8

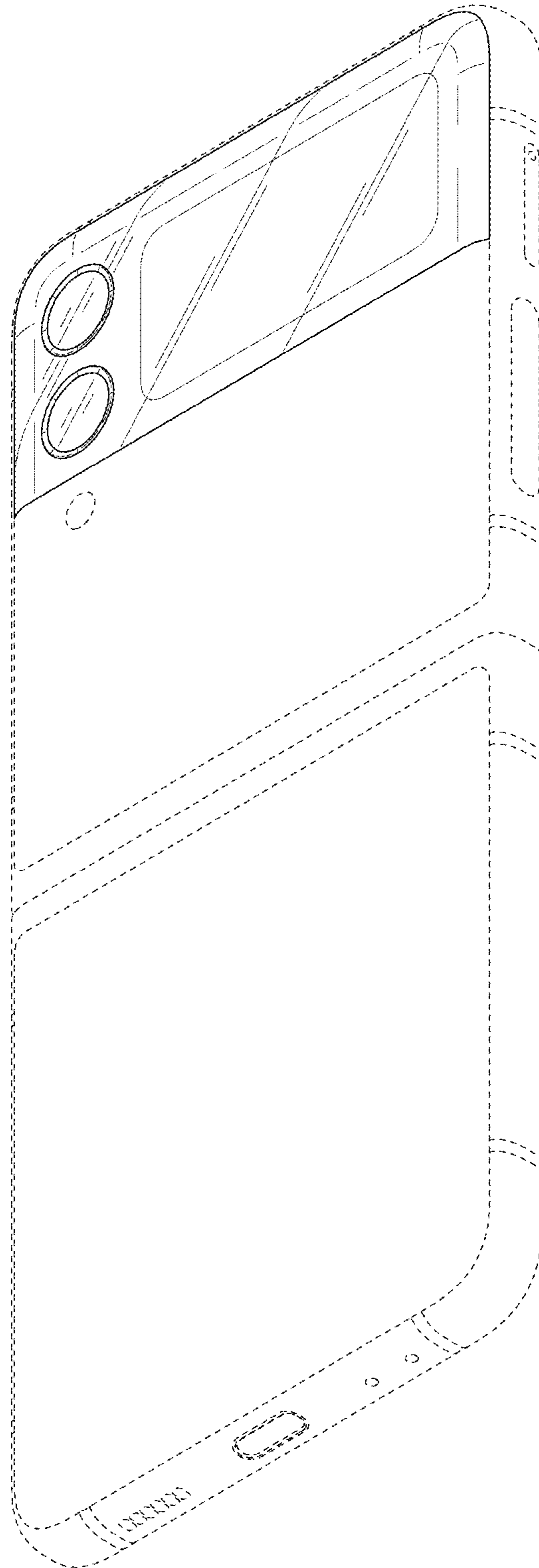



FIG. 9

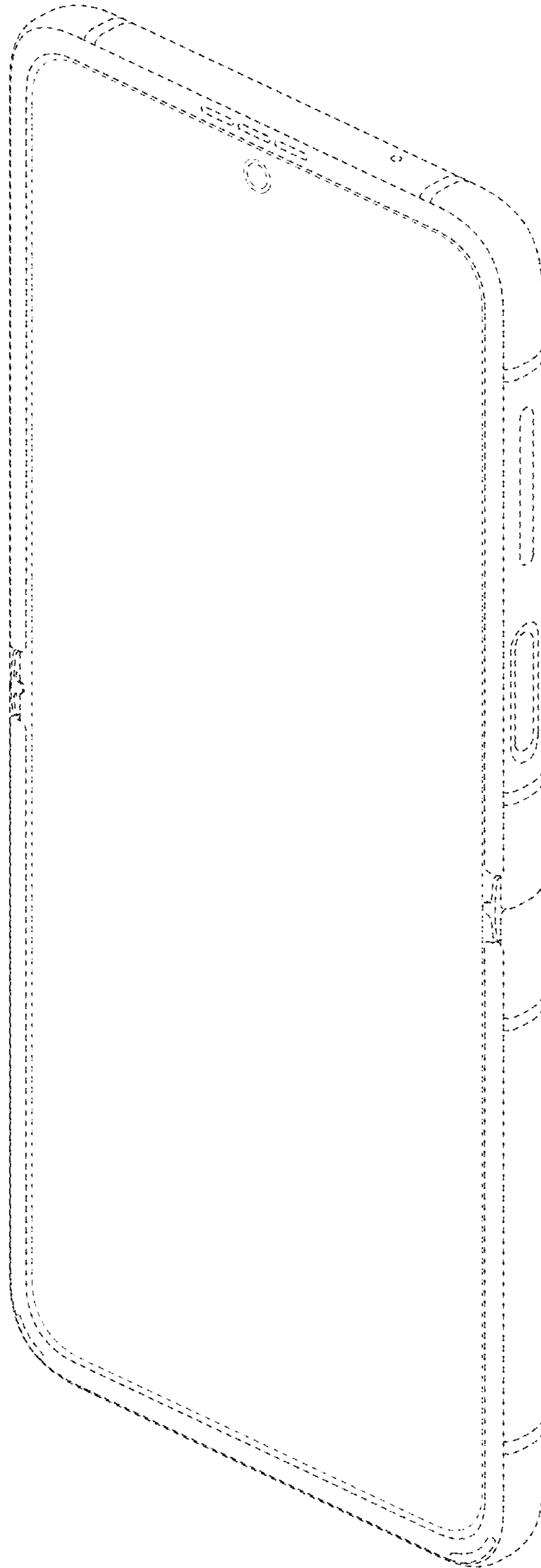

FIG. 10

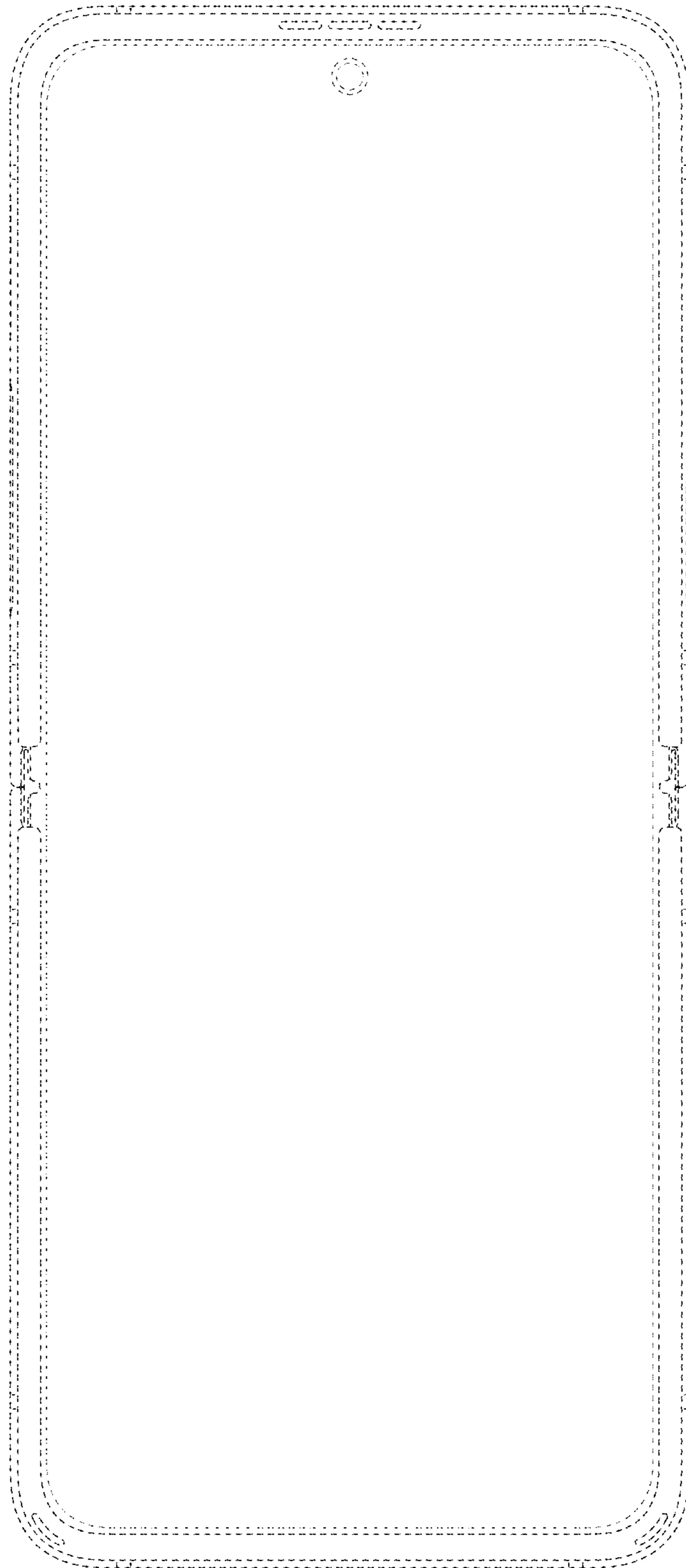

FIG. 11

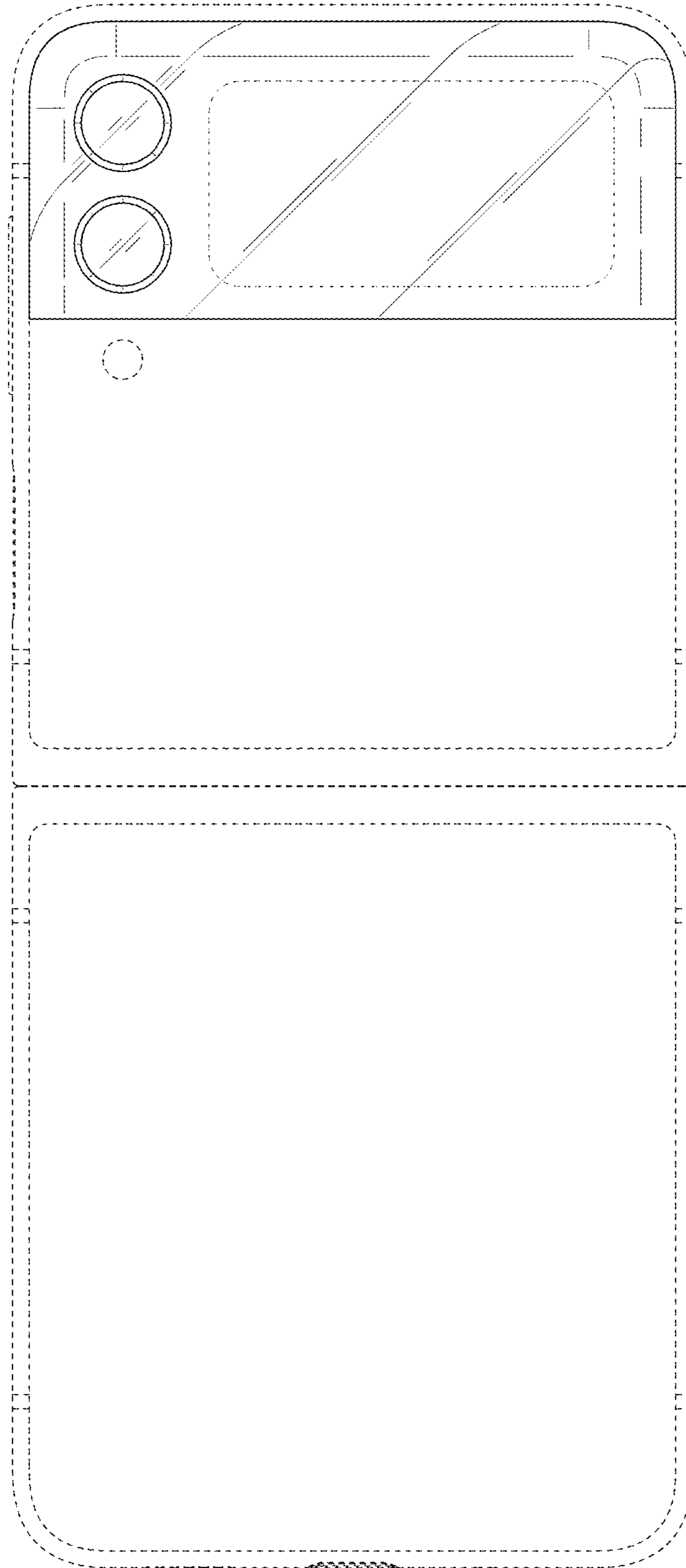

FIG. 12

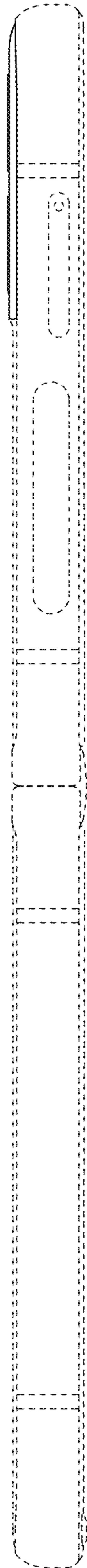

FIG. 13



FIG. 14

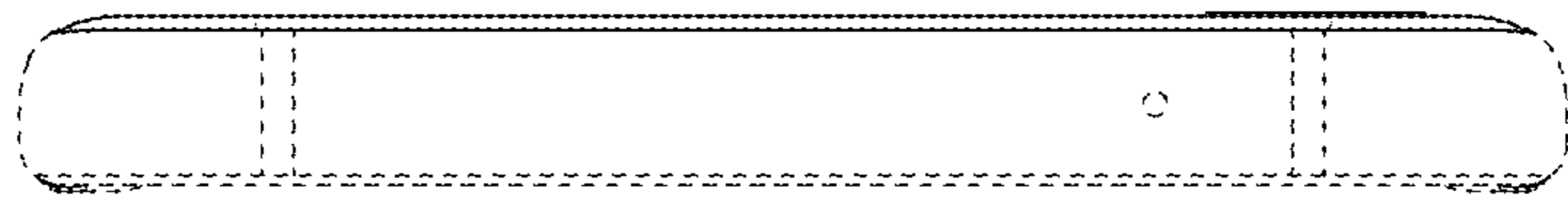

FIG. 15

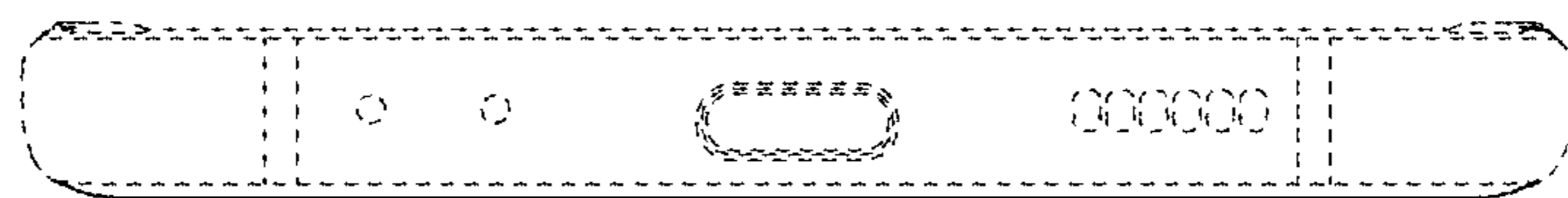

FIG. 16

