



US00D984255S

(12) **United States Design Patent** (10) **Patent No.:** **US D984,255 S**  
**Shobe** (45) **Date of Patent:** **\*\* Apr. 25, 2023**

(54) **AIR REDIRECTOR MOUNT**

(71) Applicant: **Pexco Aerospace, Inc.**, Union Gap, WA (US)

(72) Inventor: **Brandon Shobe**, Richland, WA (US)

(73) Assignee: **PEXCO AEROSPACE, INC.**, Union Gap, WA (US)

(\*\*) Term: **15 Years**

(21) Appl. No.: **29/738,674**

(22) Filed: **Jun. 18, 2020**

(51) **LOC (14) Cl.** ..... **08-05**

(52) **U.S. Cl.**  
USPC ..... **D8/380; D12/345**

(58) **Field of Classification Search**  
USPC ..... D8/354, 380, 499; D12/345; D23/386, D23/387  
CPC ..... B60H 2001/00092; B64D 13/00; B64D 13/06; B64D 2013/003; B64D 2013/0625; F24F 13/06  
See application file for complete search history.

(56) **References Cited**

**U.S. PATENT DOCUMENTS**

1,444,191	A *	2/1923	Knapp	.....	B60J 1/14 296/96.11
D65,500	S *	8/1924	Schamle	.....	D8/380
1,552,332	A *	9/1925	Miller	.....	B60J 1/14 296/96.11
1,724,696	A *	8/1929	Diederich	.....	B60J 3/005 296/152
D215,141	S *	9/1969	Harmsen	.....	D13/128
D250,805	S *	1/1979	Mygind	.....	D8/380
D257,769	S *	1/1981	Ingram	.....	D12/181
D275,431	S *	9/1984	Usab	.....	D14/452
4,749,220	A *	6/1988	Adams	.....	B62D 35/001 296/180.3
4,936,400	A *	6/1990	Blumbach	.....	B60K 11/08 55/440
D340,110	S *	10/1993	Reed	.....	D23/389

(Continued)

**OTHER PUBLICATIONS**

“AC Split deflector—air conditioning apparatus—air conditioning air deflector”, May 2, 2019, YouTube.com, site visited May 17, 2022: <https://www.youtube.com/watch?v=Gnllc4HBchc> (Year: 2019).\*

(Continued)

*Primary Examiner* — Jack Reickel

*Assistant Examiner* — Michael A Kervin

(74) *Attorney, Agent, or Firm* — Tucker Ellis LLP

(57) **CLAIM**

The ornamental design for an air redirector mount, as shown and described.

**DESCRIPTION**

FIG. 1 is a perspective view of an air redirector mount, according to a first embodiment, showing my new design; FIG. 2 is a front view thereof; FIG. 3 is a rear view thereof; FIG. 4 is a top view thereof; FIG. 5 is a bottom view thereof; FIG. 6 is a left side view thereof; FIG. 7 is a right side view thereof; FIG. 8 is a perspective view of the air redirector mount, according to a second embodiment showing my new design; FIG. 9 is a front view thereof; FIG. 10 is a rear view thereof; FIG. 11 is a top view thereof; FIG. 12 is a bottom view thereof; FIG. 13 is a left side view thereof; and, FIG. 14 is a right side view thereof.

The broken line showing of an air redirector mount is for the purpose of illustrating portions of the article and form no part of the claimed design.

**1 Claim, 10 Drawing Sheets**

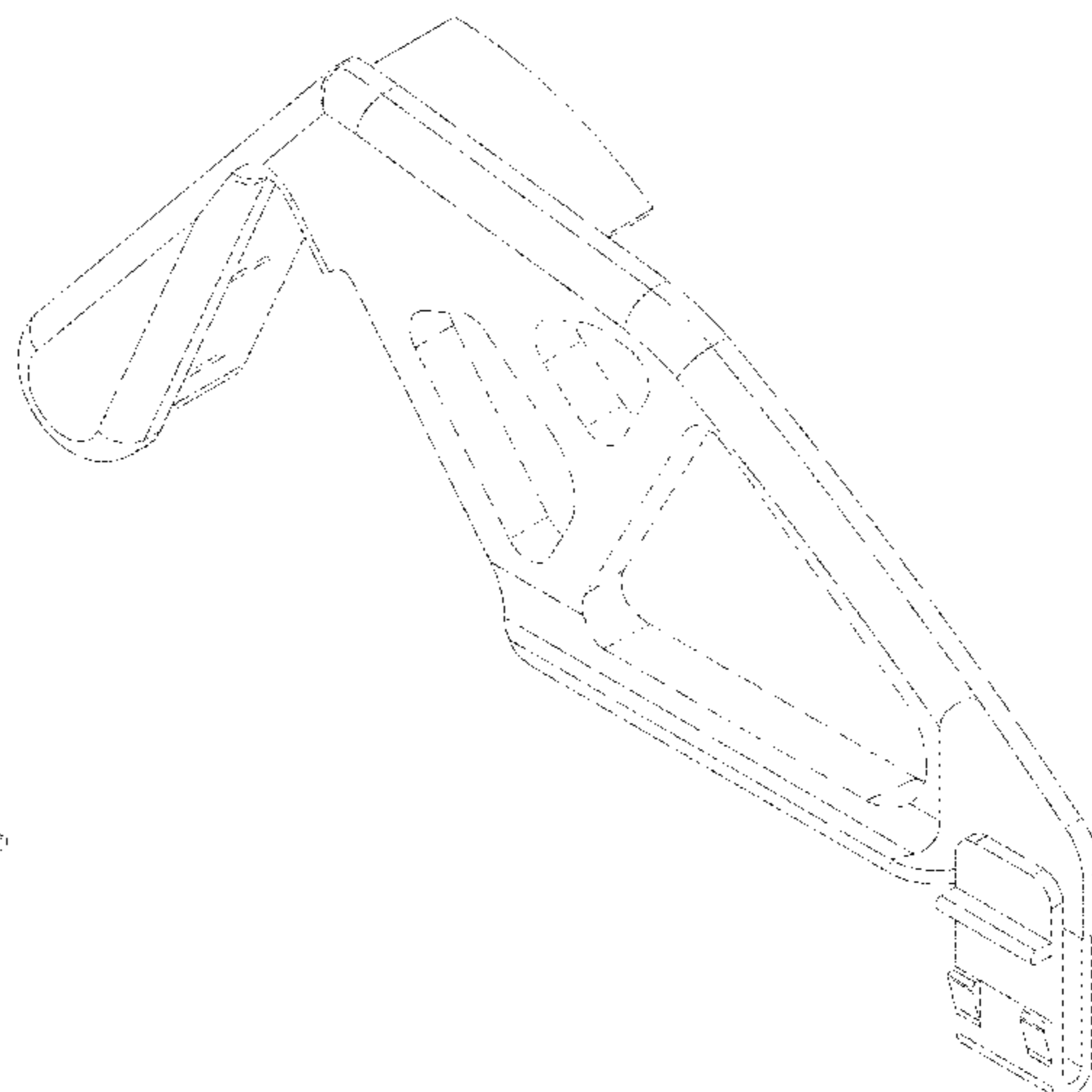
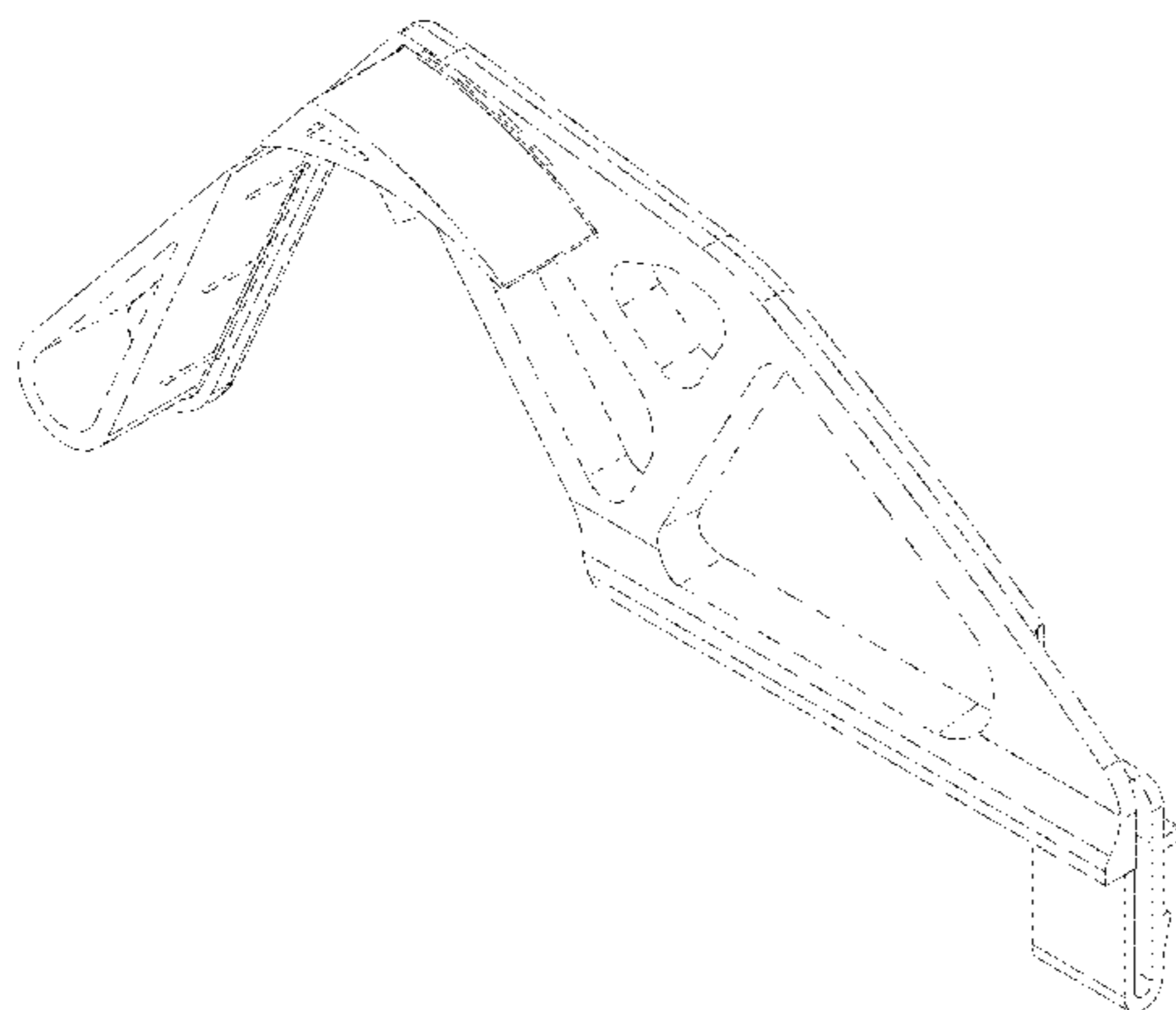

(56)

References Cited

U.S. PATENT DOCUMENTS

D419,854 S \* 2/2000 Brousseau ..... D8/354  
D536,238 S \* 2/2007 Conley ..... D8/354  
7,626,819 B1 \* 12/2009 Chen ..... G06F 1/20  
361/695  
D616,290 S \* 5/2010 Sullivan ..... D8/380  
D668,136 S \* 10/2012 Nicholls ..... D8/380  
D685,253 S \* 7/2013 Hiebert ..... D8/349  
D691,459 S \* 10/2013 Waugh ..... D8/354  
D699,662 S \* 2/2014 Aruga ..... D12/345  
8,696,418 B1 \* 4/2014 Griffin ..... B64D 13/00  
454/76  
D746,214 S \* 12/2015 Tran ..... D12/174  
D787,916 S \* 5/2017 Yuan ..... D12/223  
9,873,314 B1 \* 1/2018 Grimaldo ..... B60J 7/22  
D889,512 S \* 7/2020 Hudnall ..... D15/5  
D892,025 S \* 8/2020 Jones ..... D12/223  
2009/0320906 A1 \* 12/2009 Botkin ..... H02S 30/10  
136/251

2013/0187414 A1 \* 7/2013 Nowack ..... B60J 7/22  
296/217  
2014/0148229 A1 \* 5/2014 Hillen ..... A01F 12/444  
460/99  
2015/0140914 A1 \* 5/2015 Schneider ..... B64D 11/00  
454/76  
2016/0325839 A1 \* 11/2016 Wang ..... B60H 1/3414  
2017/0108164 A1 \* 4/2017 Rosen ..... B64D 13/06  
2018/0105015 A1 \* 4/2018 Haupt ..... B60H 1/00028  
2018/0186223 A1 \* 7/2018 Geurts ..... B60J 7/22  
2018/0272848 A1 \* 9/2018 Biasi da Silva ..... B60J 7/22  
2019/0234235 A1 \* 8/2019 Anderson ..... F01D 9/041  
2022/0041287 A1 \* 2/2022 Taylor ..... F24F 13/06

OTHER PUBLICATIONS

“Air Conditioning Wind Deflector Telescopic”, Jun. 10, 2019,  
Amazon.ca, site visited May 17, 2022: <https://www.amazon.ca/Air-Conditioning-Deflector-Telescopic-Wall-Mounted-Conditioner/dp/B07SVZSCVX> (Year: 2019).\*

\* cited by examiner

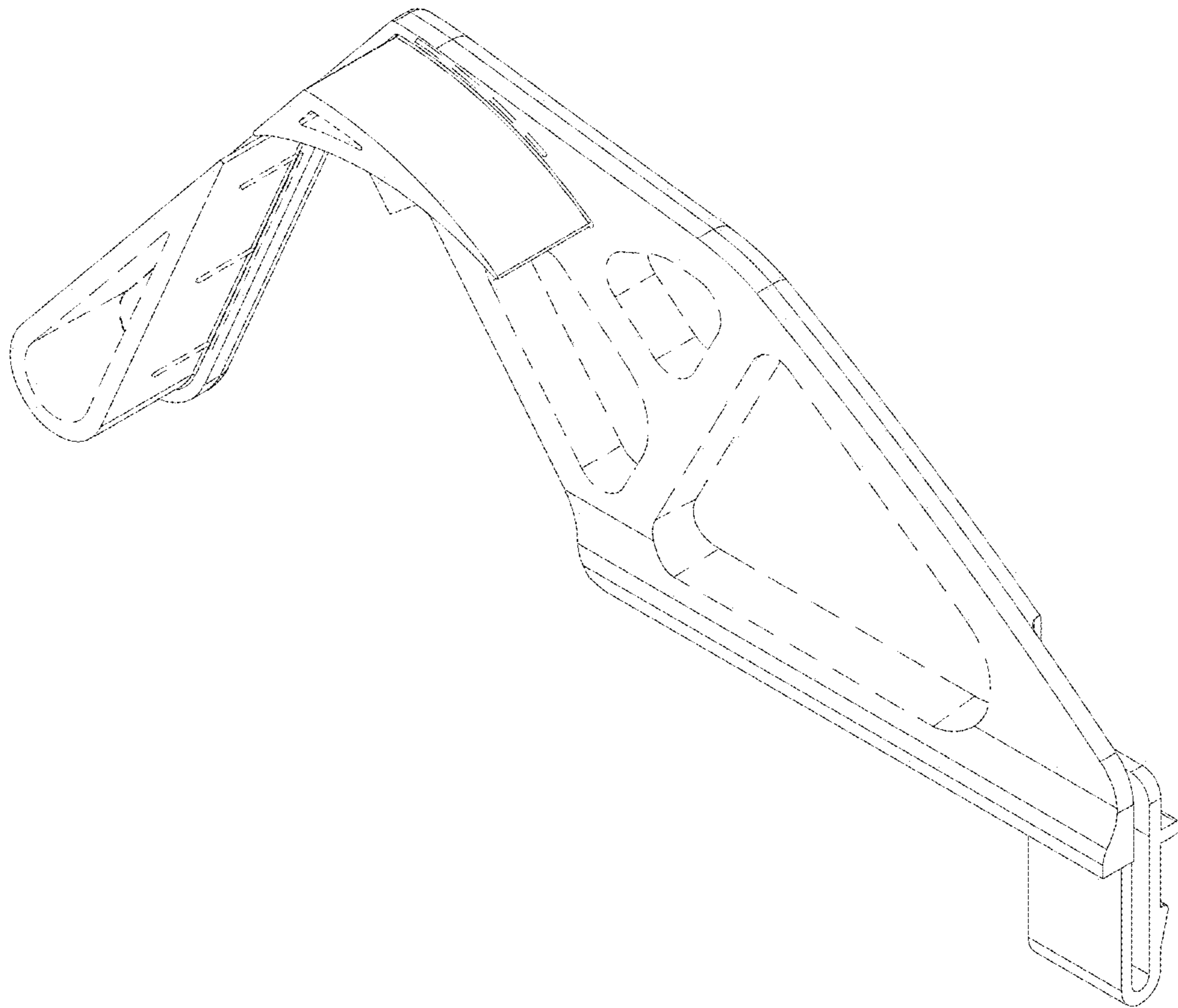

FIG. 1

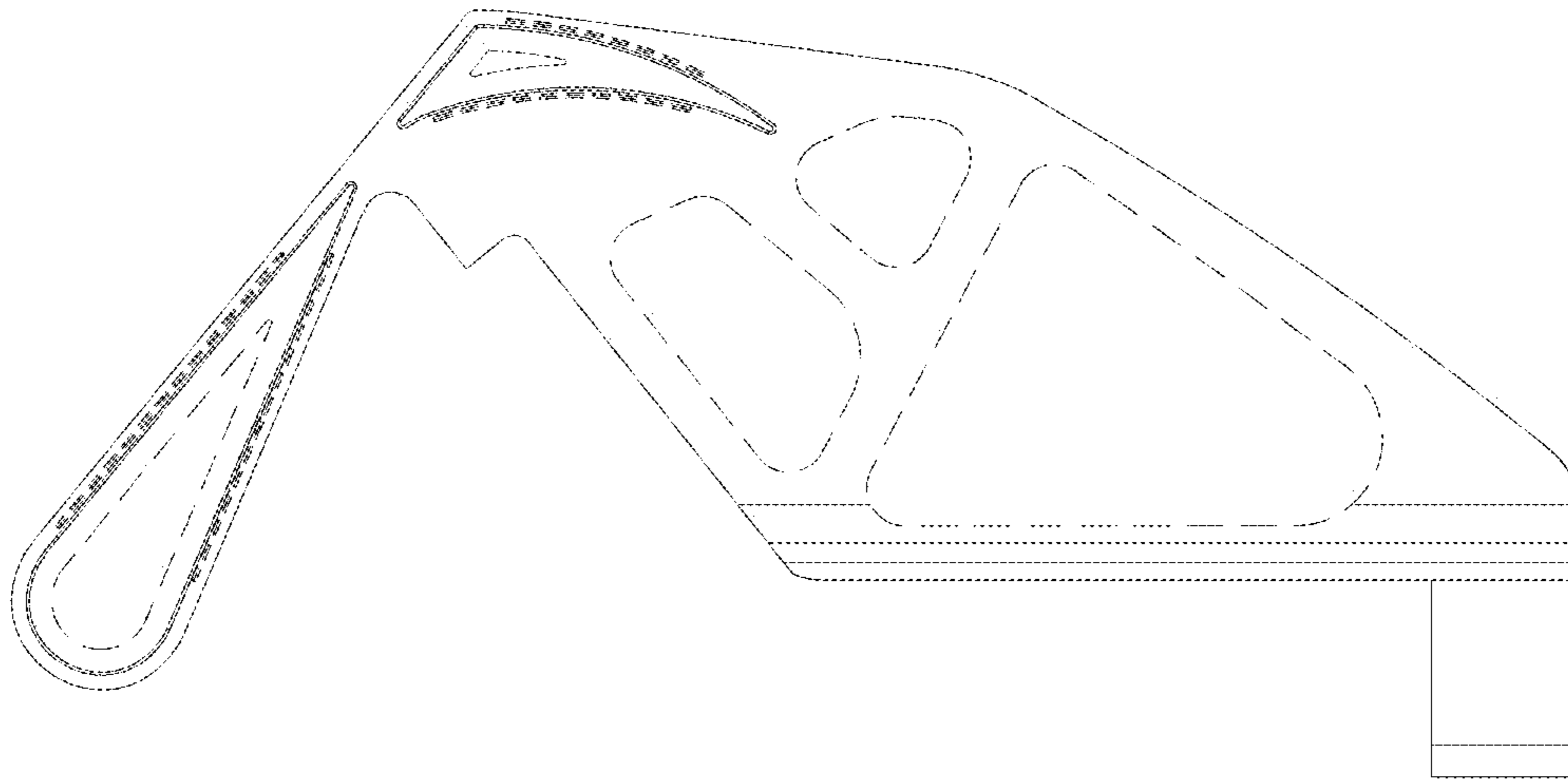

FIG. 2

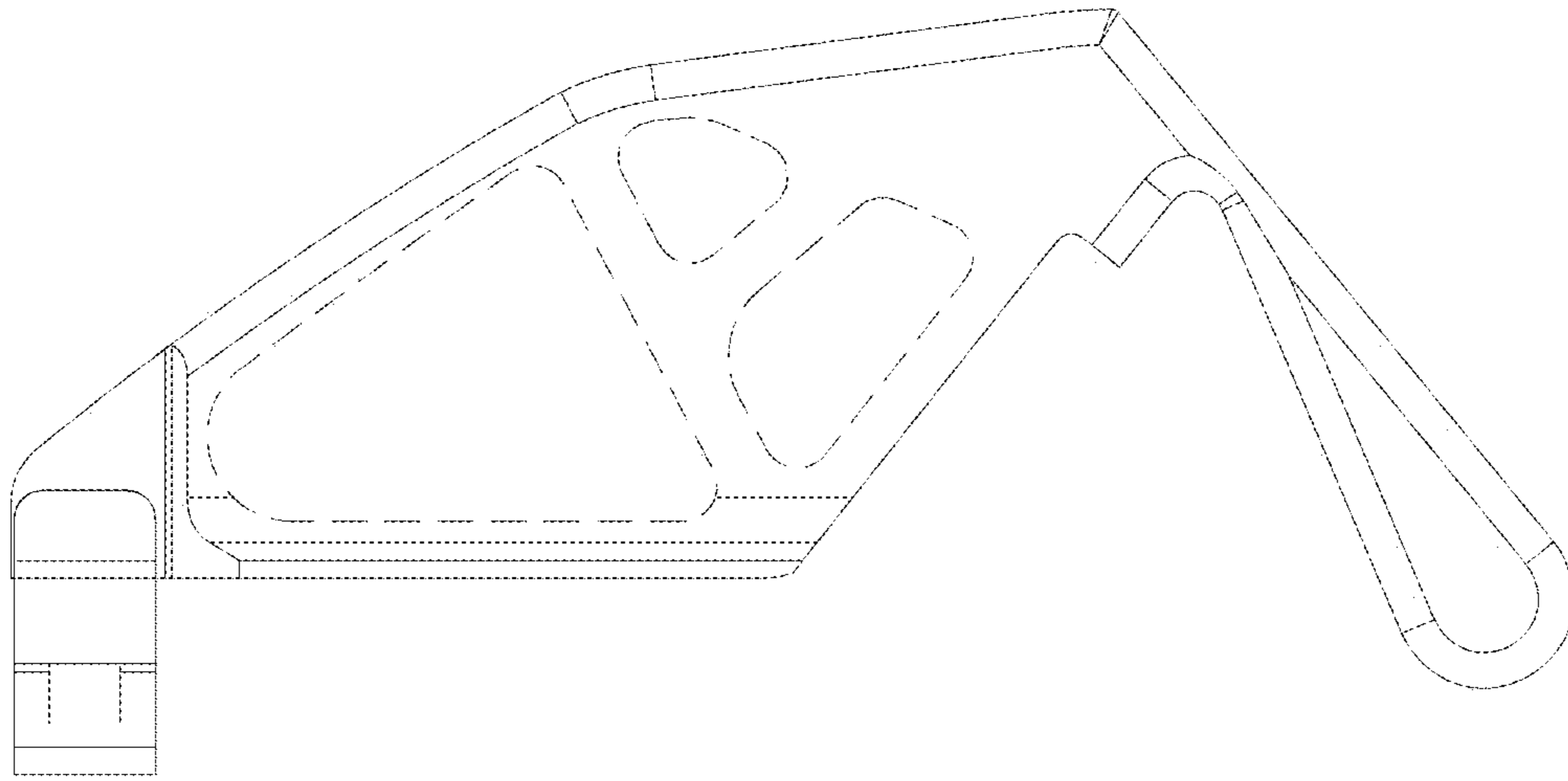

FIG. 3

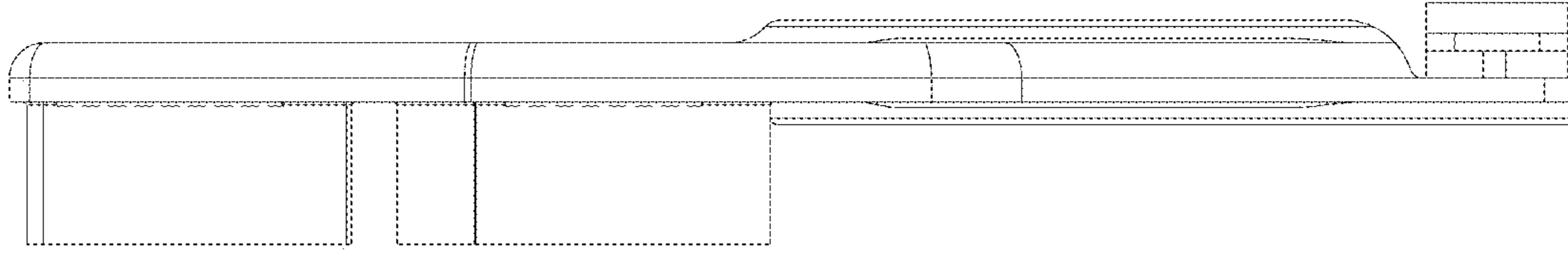

FIG. 4

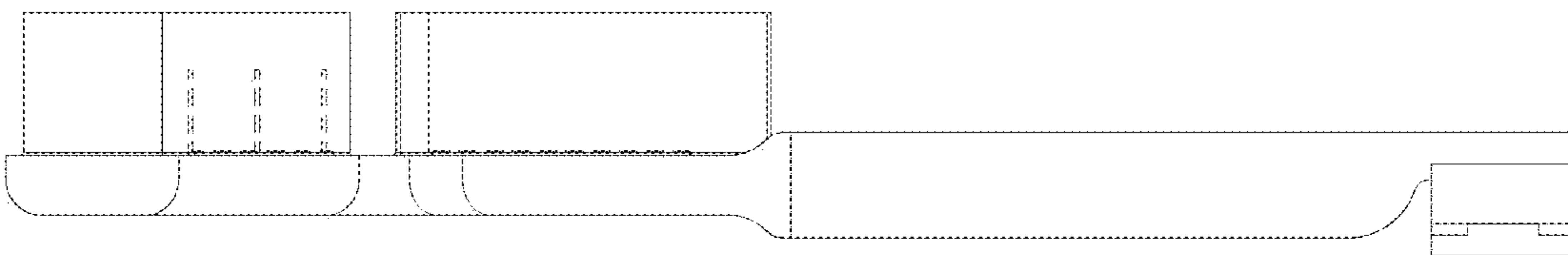

FIG. 5

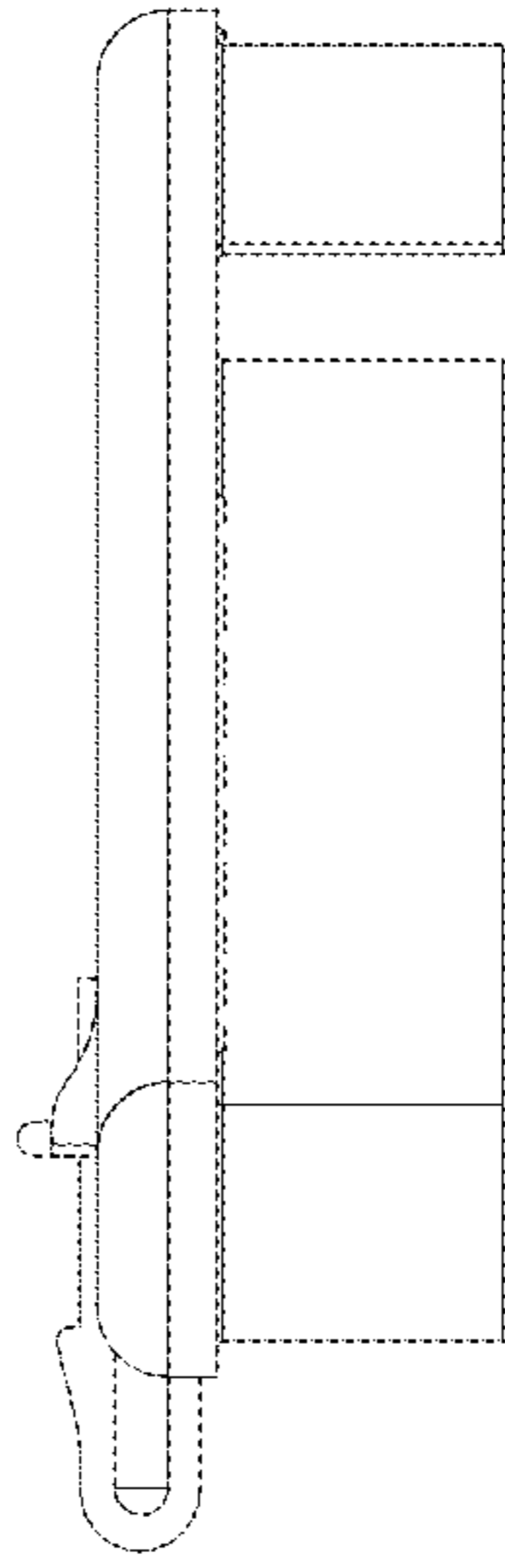

FIG. 6

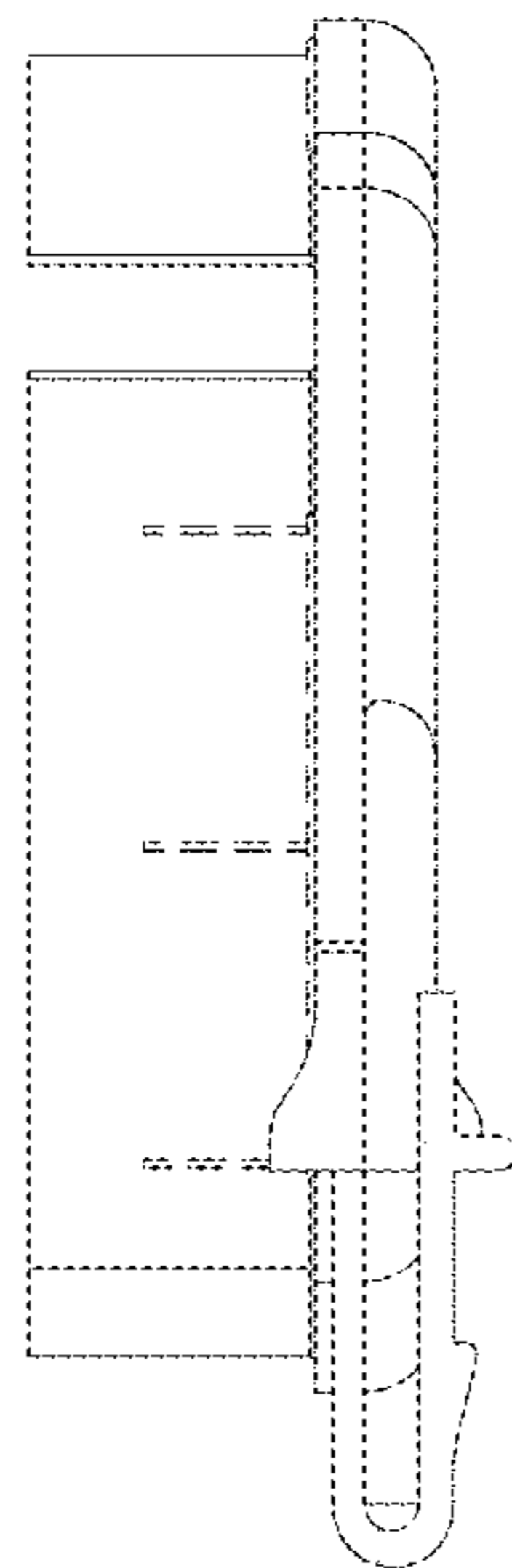

FIG. 7

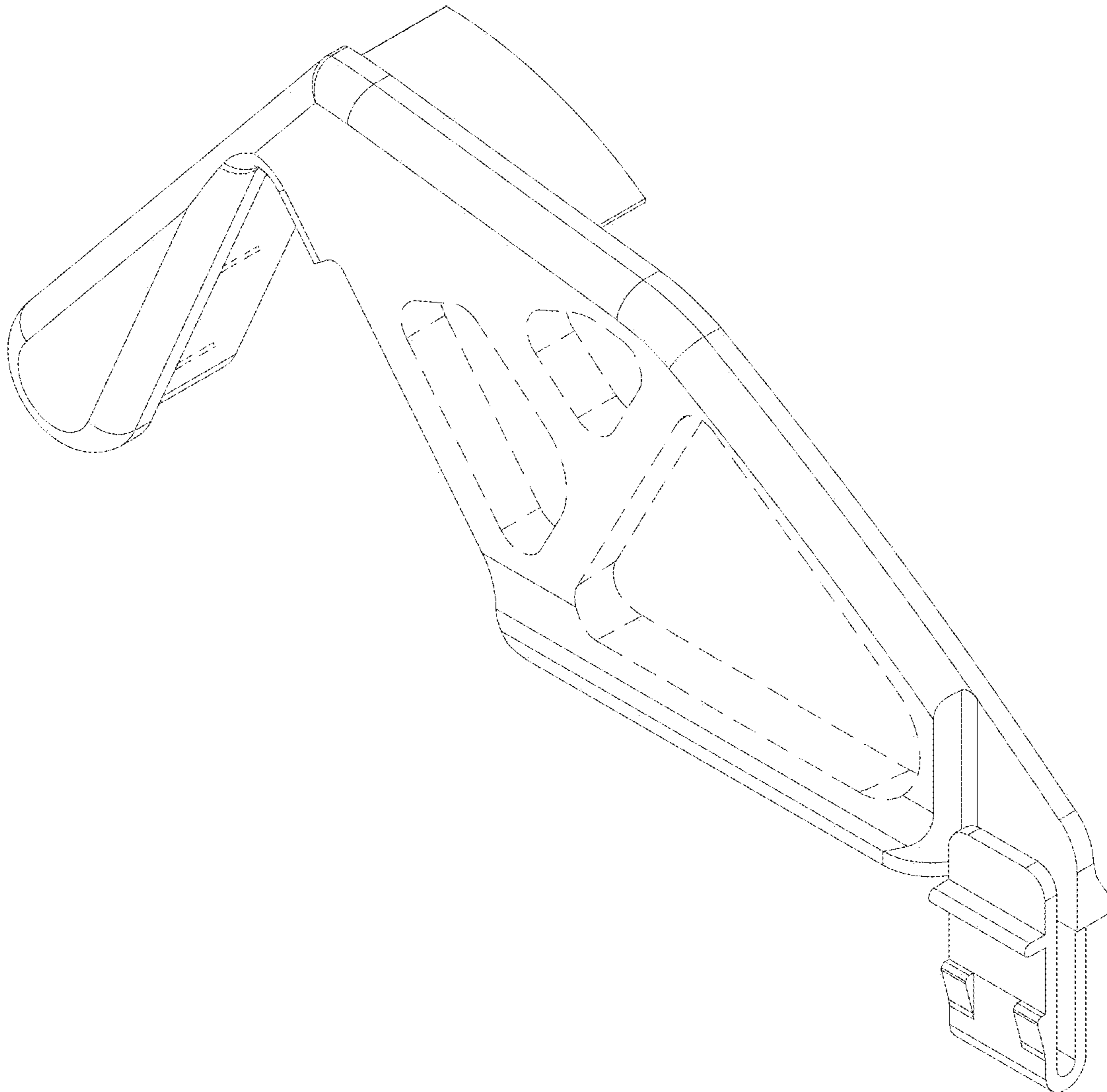

FIG. 8



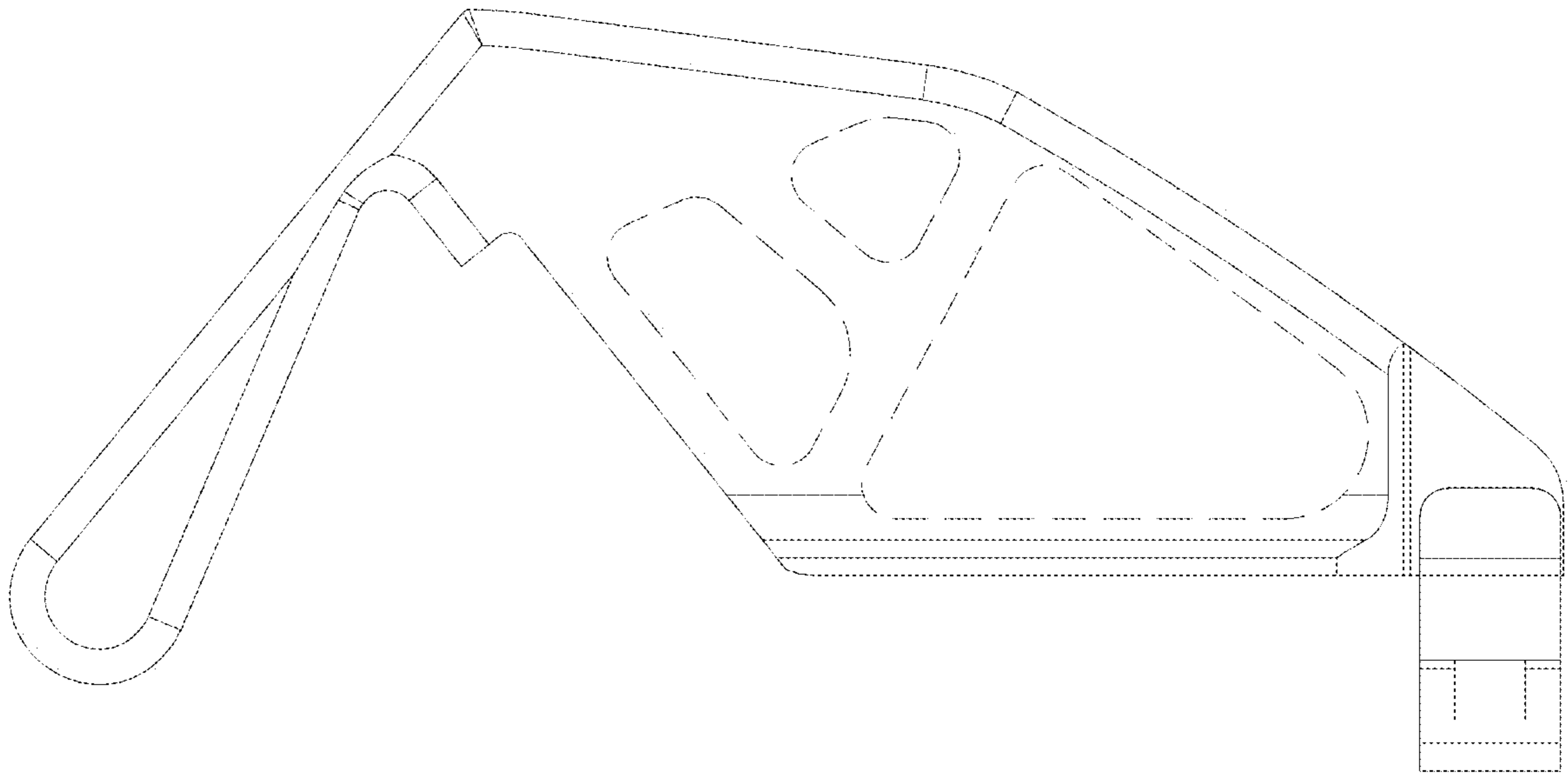

FIG. 9

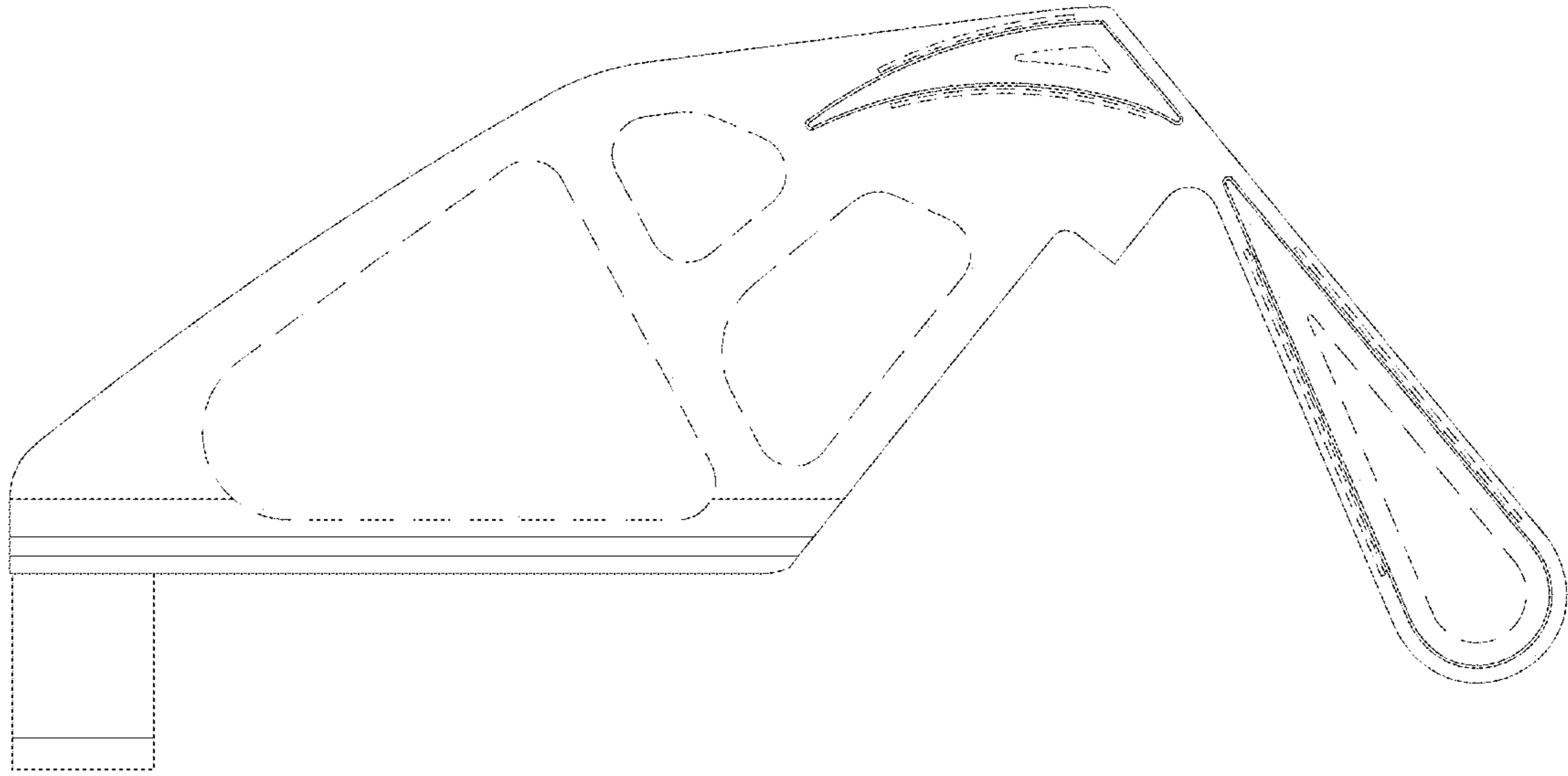

FIG. 10

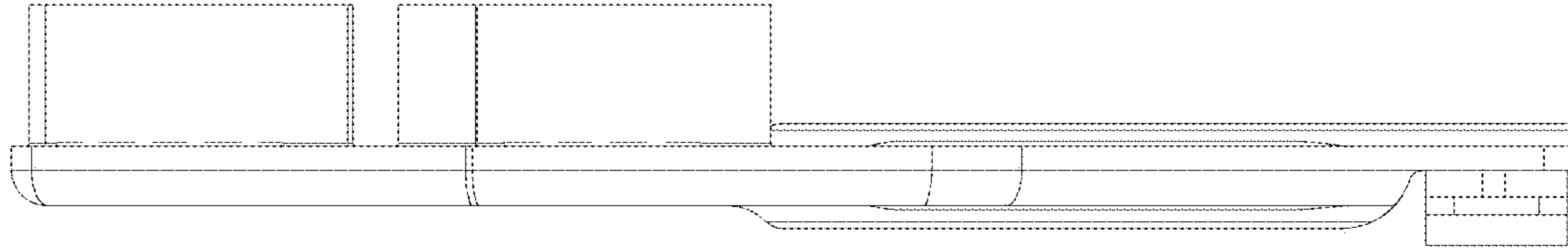

FIG. 11

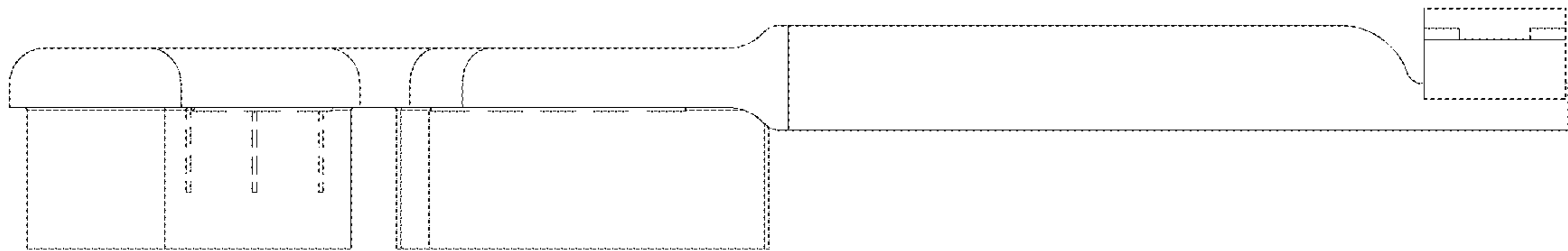

FIG. 12

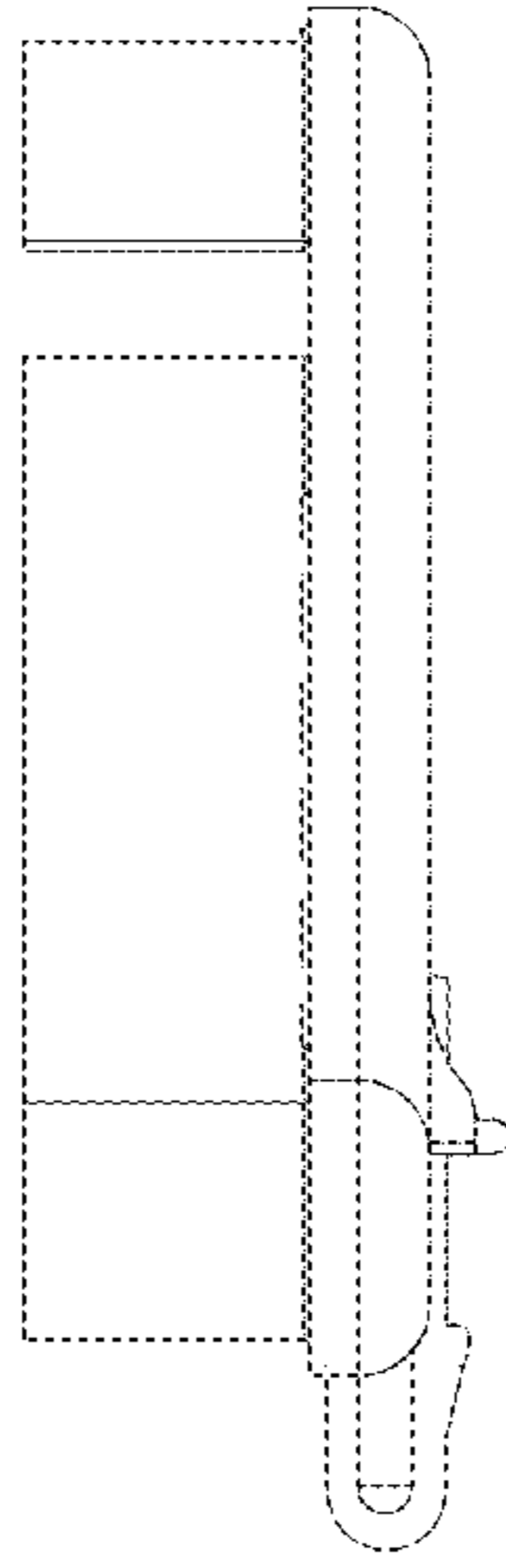

FIG. 13

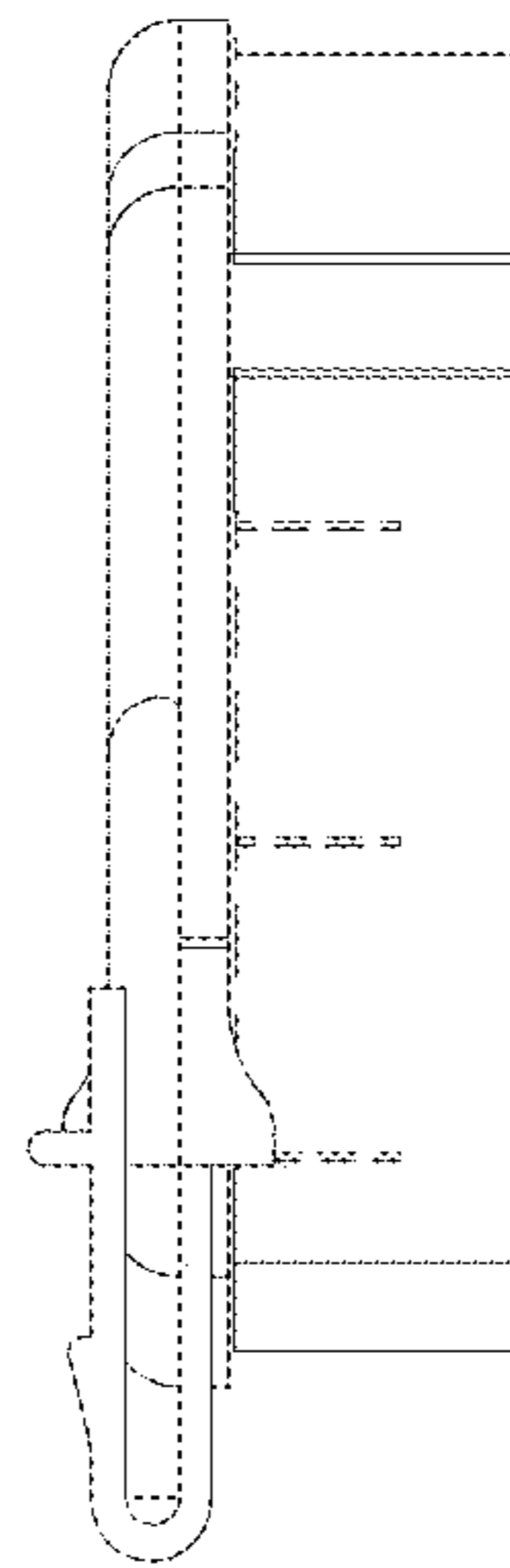

FIG. 14