



US00D984215S

(12) **United States Design Patent**
Hietikko

(10) **Patent No.:** **US D984,215 S**
(45) **Date of Patent:** **** Apr. 25, 2023**

(54) **BEVERAGE CONTAINER**

(71) Applicant: **The Coleman Company, Inc.**, Wichita, KS (US)

(72) Inventor: **Dakota Hietikko**, Kalamazoo, MI (US)

(73) Assignee: **The Coleman Company, Inc.**, Wichita, KS (US)

(**) Term: **15 Years**

(21) Appl. No.: **29/774,563**

(22) Filed: **Mar. 17, 2021**

(51) **LOC (14) Cl.** **07-01**

(52) **U.S. Cl.**
USPC **D7/511; D7/510; D7/532**

(58) **Field of Classification Search**
USPC D7/507, 509, 510, 511, 523, 531, 532,
D7/608, 392.1, 396.2; D9/500, 501, 502,
D9/558, 547

CPC A47G 19/22; A47G 19/25; A47G 19/2288;
A61J 41/028; A47J 41/0077; A47J 41/02
See application file for complete search history.

(56) **References Cited**

U.S. PATENT DOCUMENTS

6,626,326	B2	9/2003	Murakami	
D655,134	S	3/2012	Gilbert	
D657,246	S *	4/2012	Nemeth	D7/509
D675,066	S	1/2013	Conlin	
D695,138	S	12/2013	Ball	
D761,624	S *	7/2016	McLean	D7/532
D843,174	S *	3/2019	Zhang	D7/532
10,457,471	B2	10/2019	Jacob	
D878,156	S *	3/2020	Rittri	D7/511
10,582,791	B2	3/2020	Stevens	
D887,781	S *	6/2020	Bergström	D7/532
10,677,516	B2	6/2020	Huisman	
10,773,873	B2	9/2020	Callinan	
10,835,067	B2	11/2020	Rane	
D904,119	S	12/2020	Jacob	

D947,612 S * 4/2022 Wu D9/504
2018/0310766 A1 11/2018 Lapsker
2019/0382187 A1 12/2019 Callinan

OTHER PUBLICATIONS

<https://www.businessinsider.com/golchi-thermos-stores-hot-and-cold-drinks-2016-6> Jun. 16, 2016 (Year: 2016).*

* cited by examiner

Primary Examiner — Jae Liang
Assistant Examiner — Ji Sun Yoon

(57) **CLAIM**

The ornamental design for a beverage container, as shown and described.

DESCRIPTION

FIG. 1 is a front perspective view of a beverage container with lid in closed position;
FIG. 2 is a front view thereof;
FIG. 3 is a rear view thereof;
FIG. 4 is left side view thereof;
FIG. 5 is a right side view thereof;
FIG. 6 is a top view thereof;
FIG. 7 is a bottom view thereof;
FIG. 8 is a front perspective view of a beverage container with lid in open position;
FIG. 9 is a front view thereof;
FIG. 10 is a rear view thereof;
FIG. 11 is left side view thereof;
FIG. 12 is a right side view thereof;
FIG. 13 is a top view thereof; and,
FIG. 14 is a bottom view thereof.
The broken lines depict portions of the beverage container that form no part of the claimed design.

1 Claim, 12 Drawing Sheets

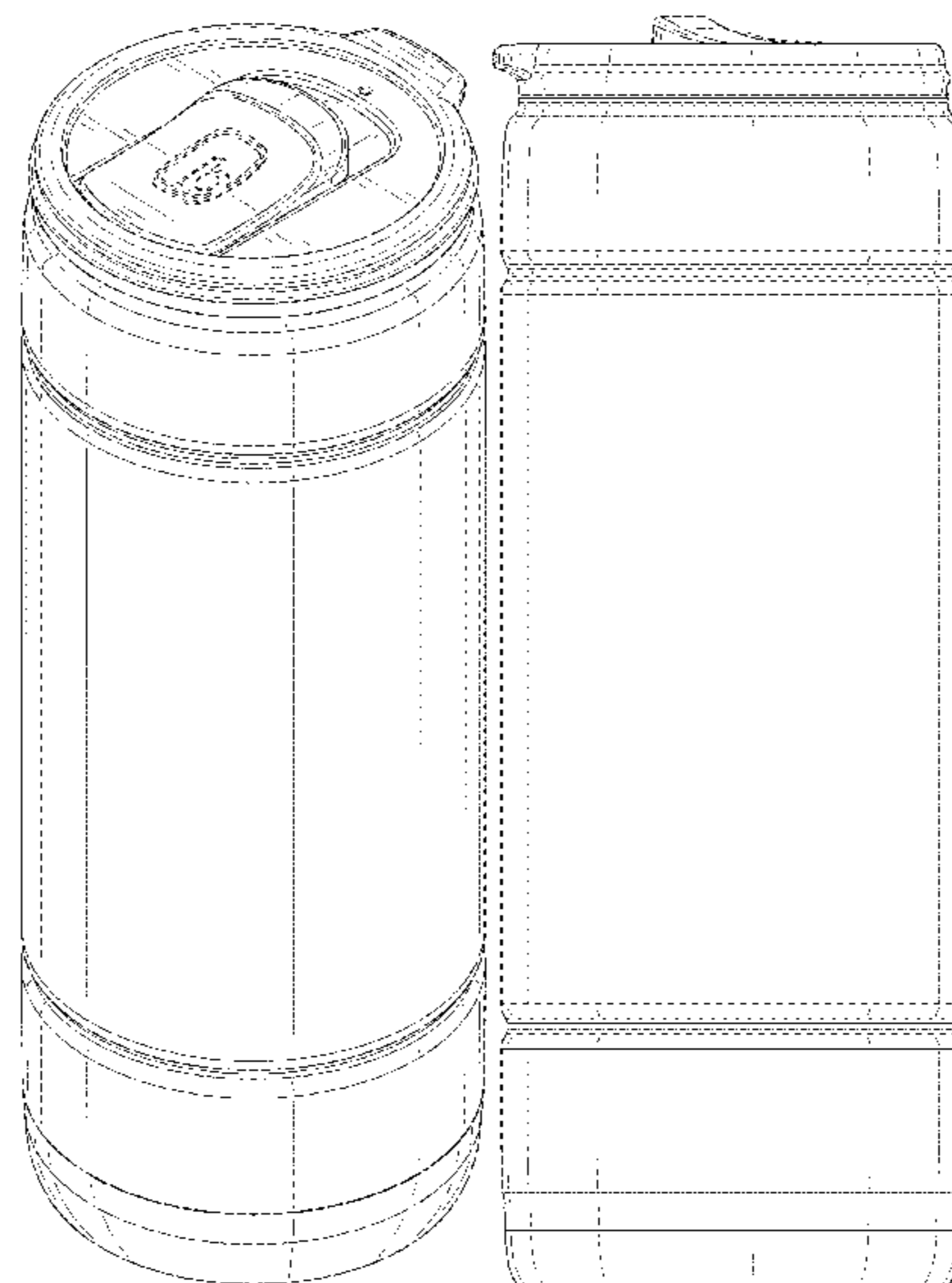

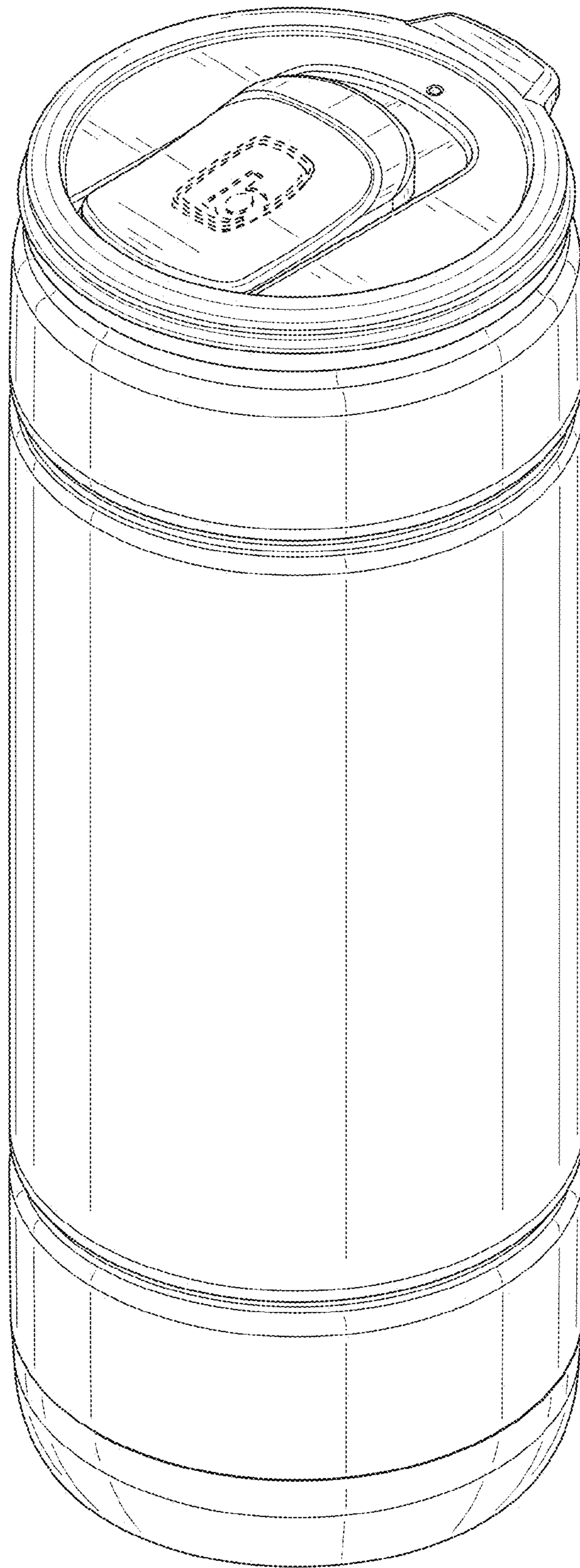

FIG. 1

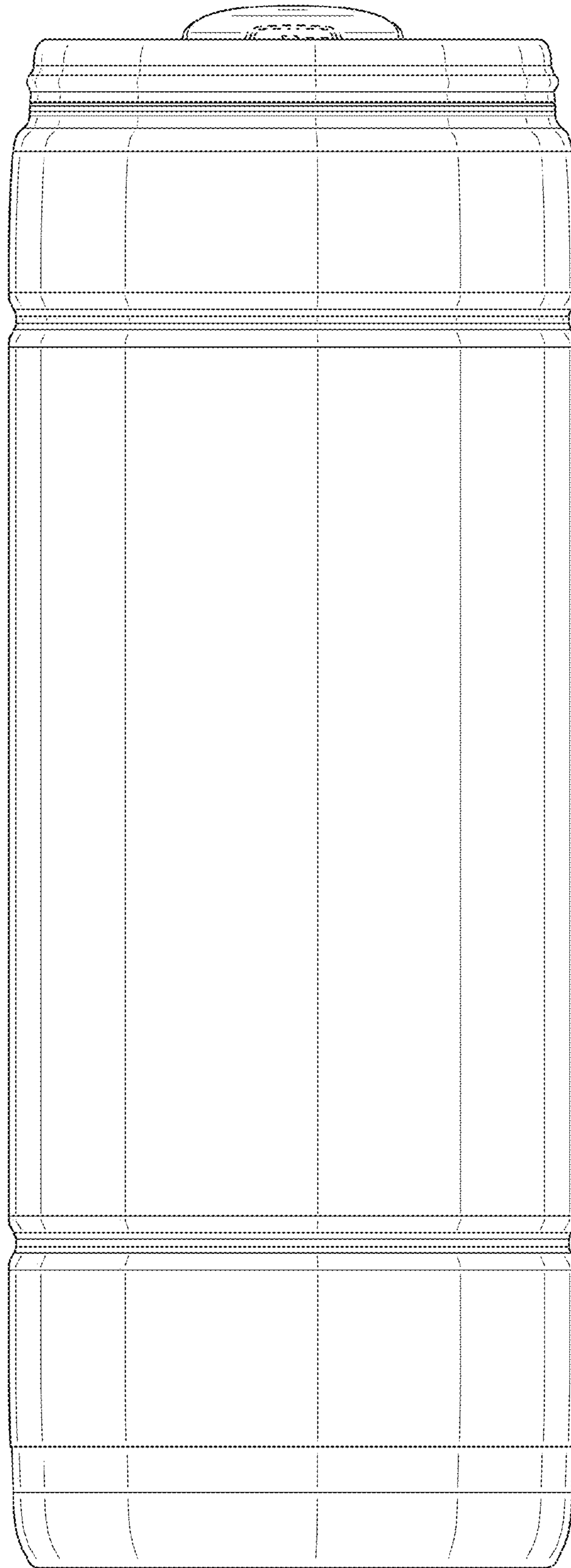

FIG. 2

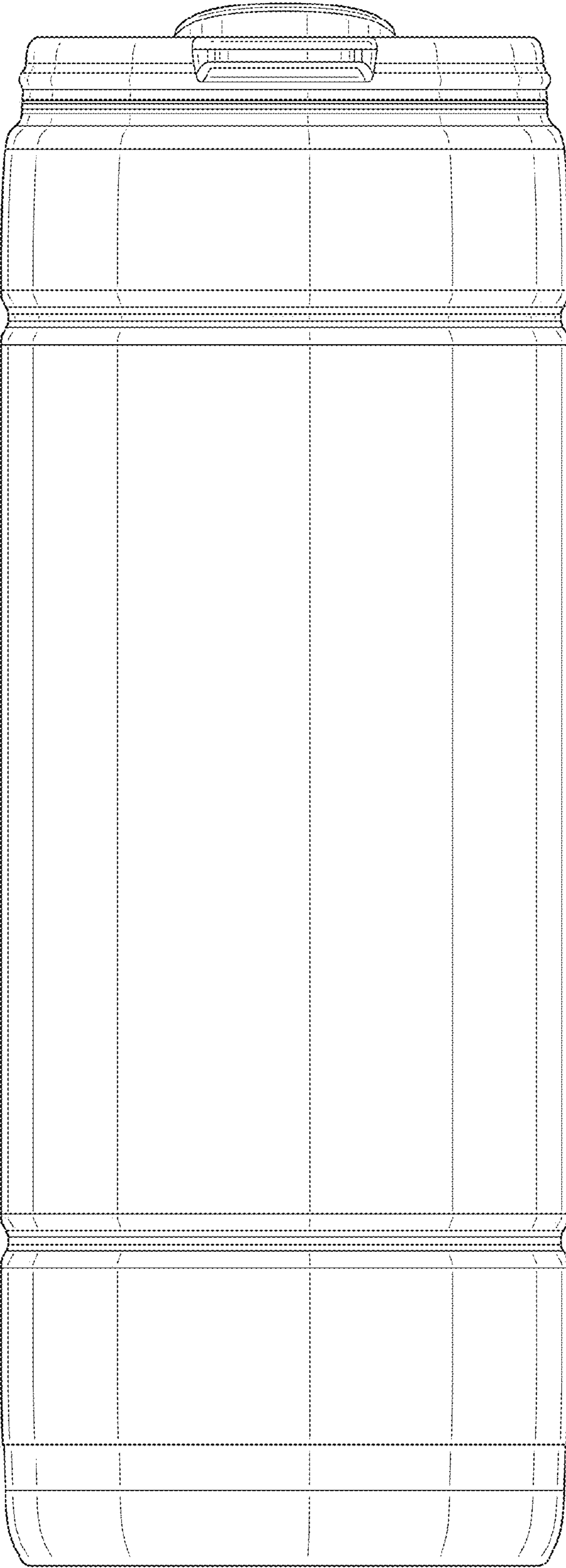

FIG. 3

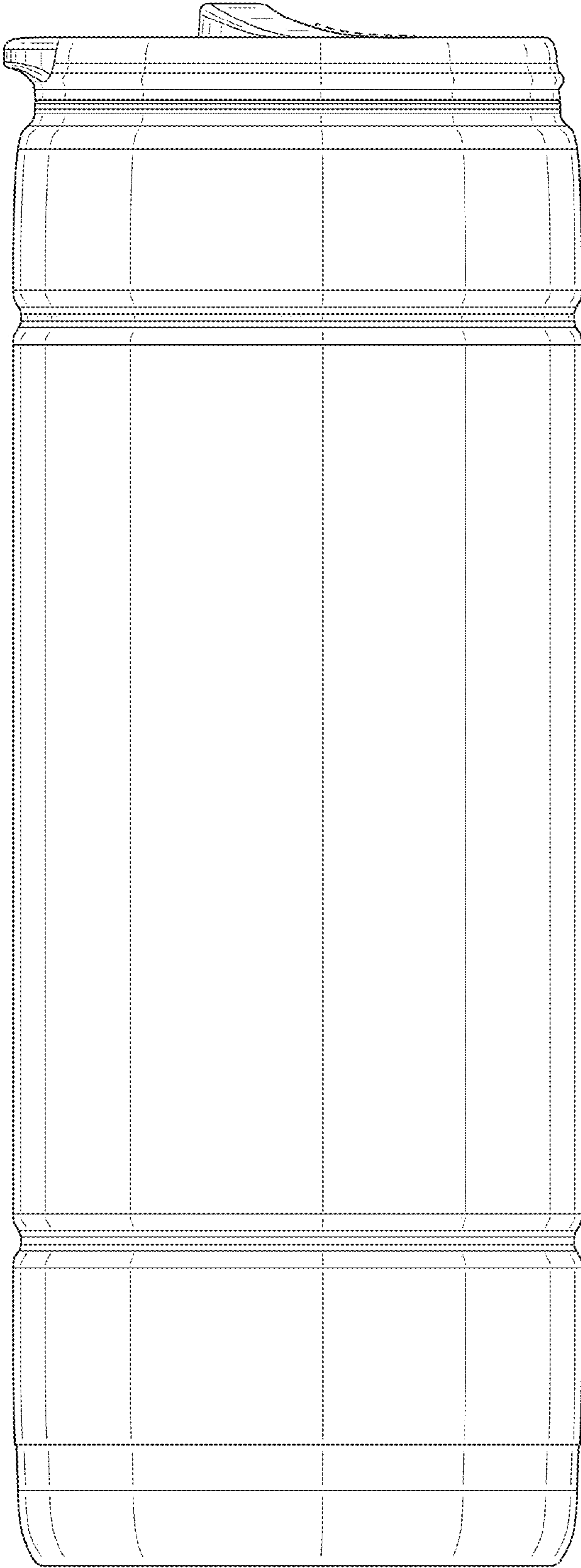

FIG. 4

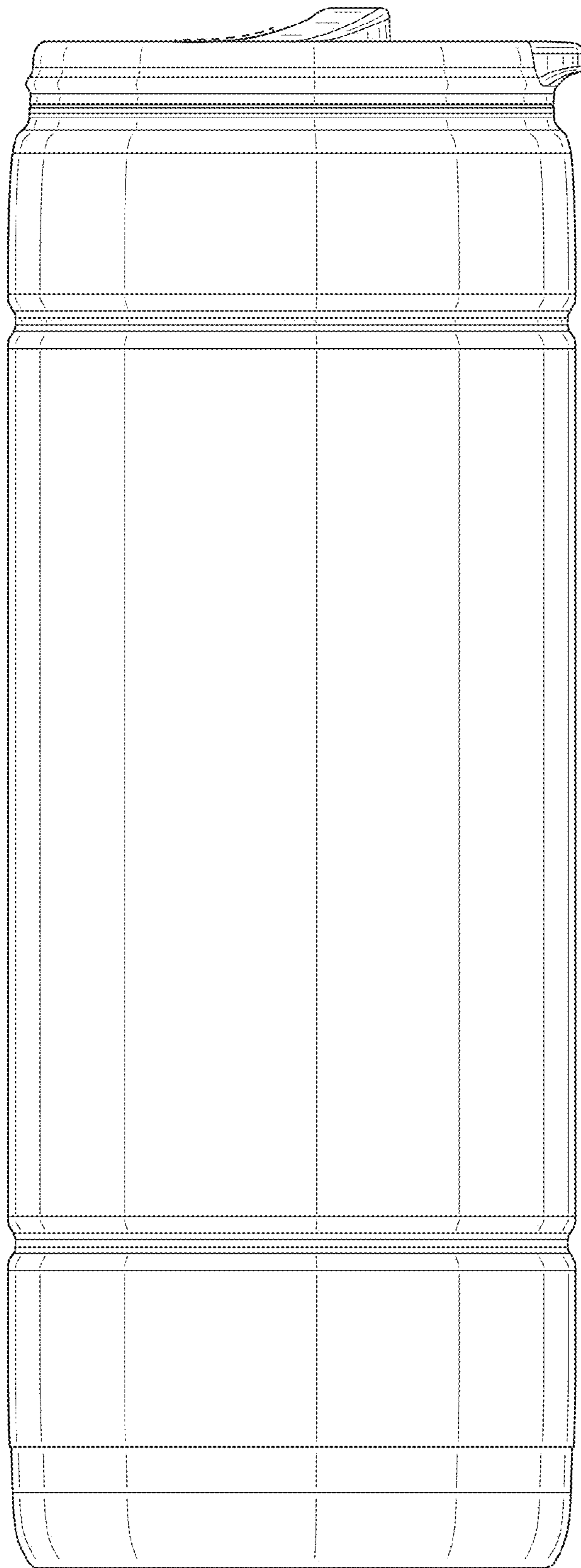

FIG. 5

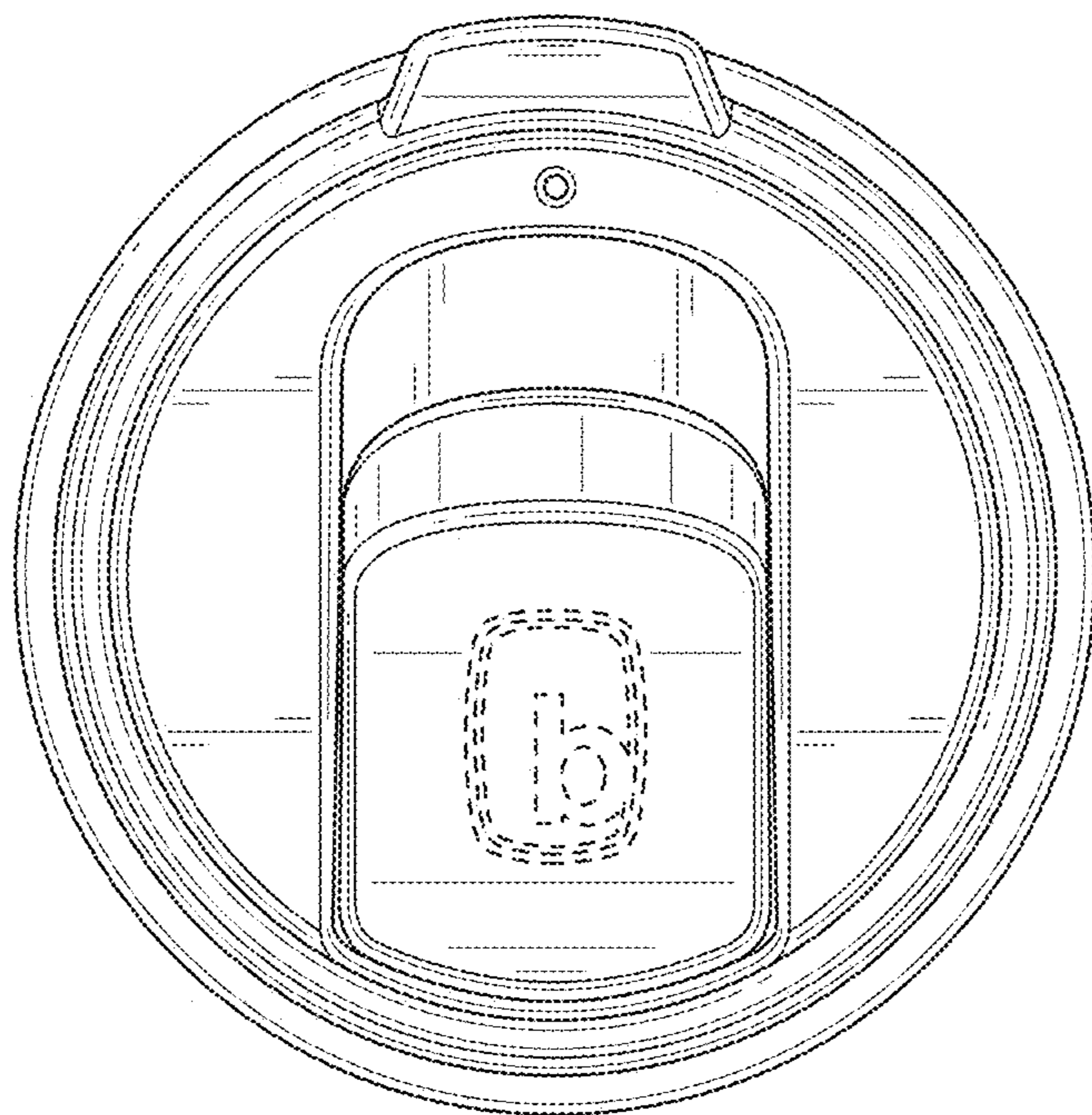

FIG. 6

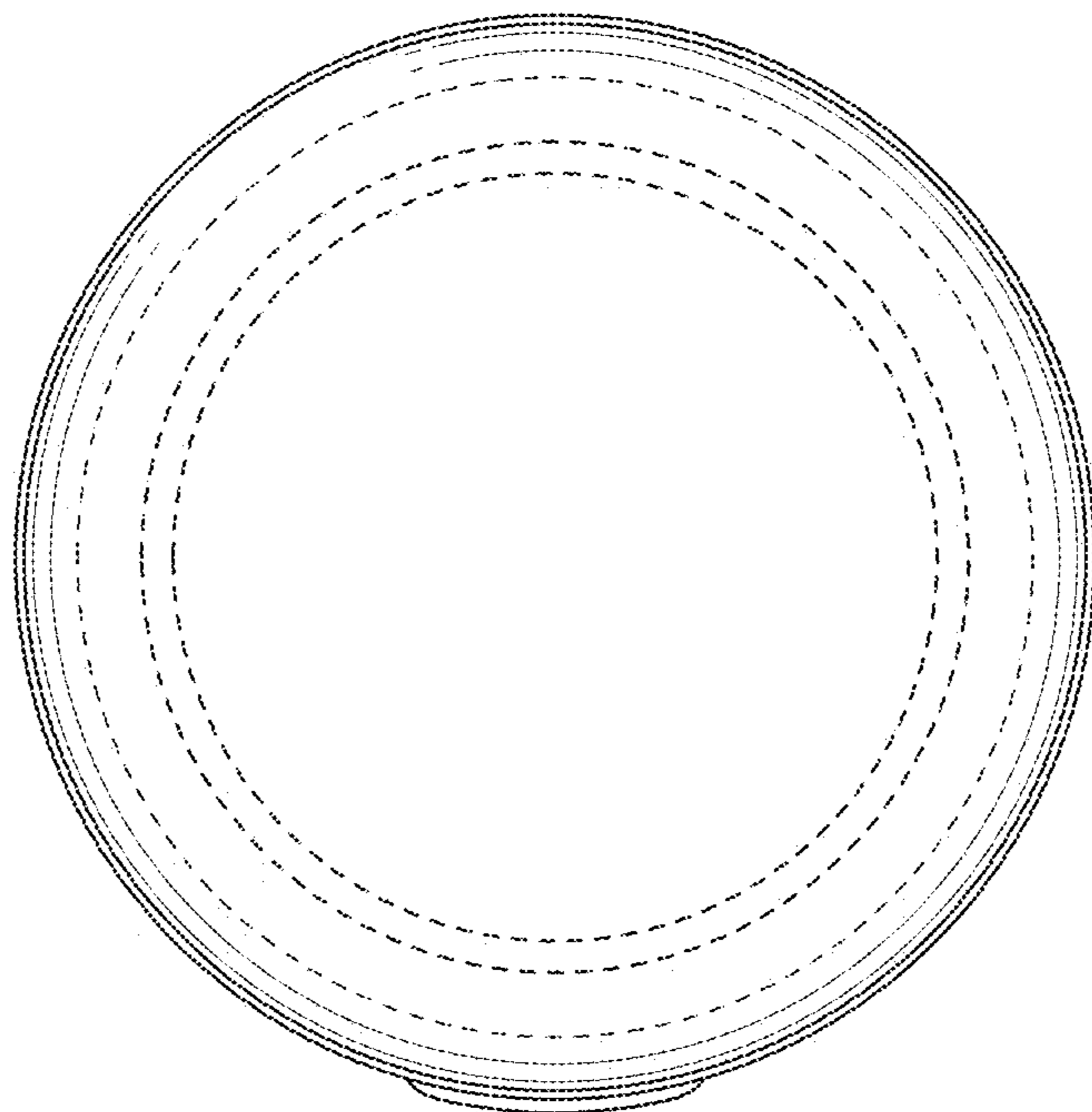

FIG. 7

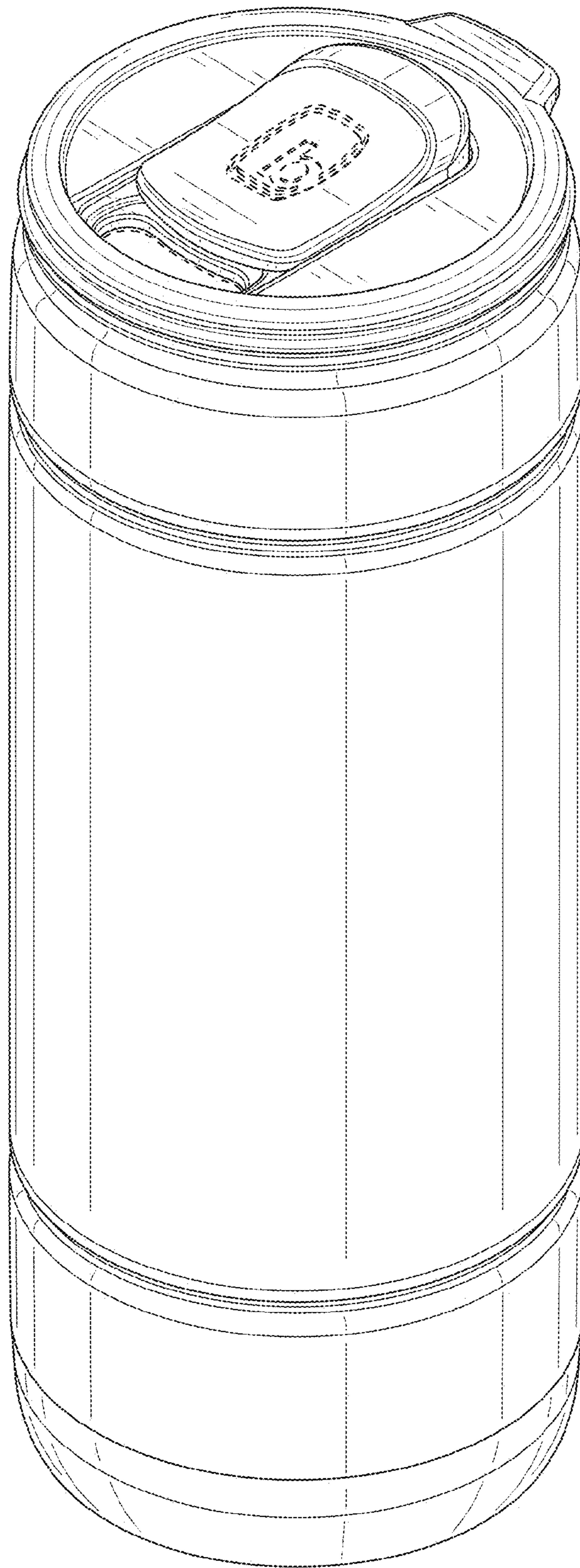

FIG. 8

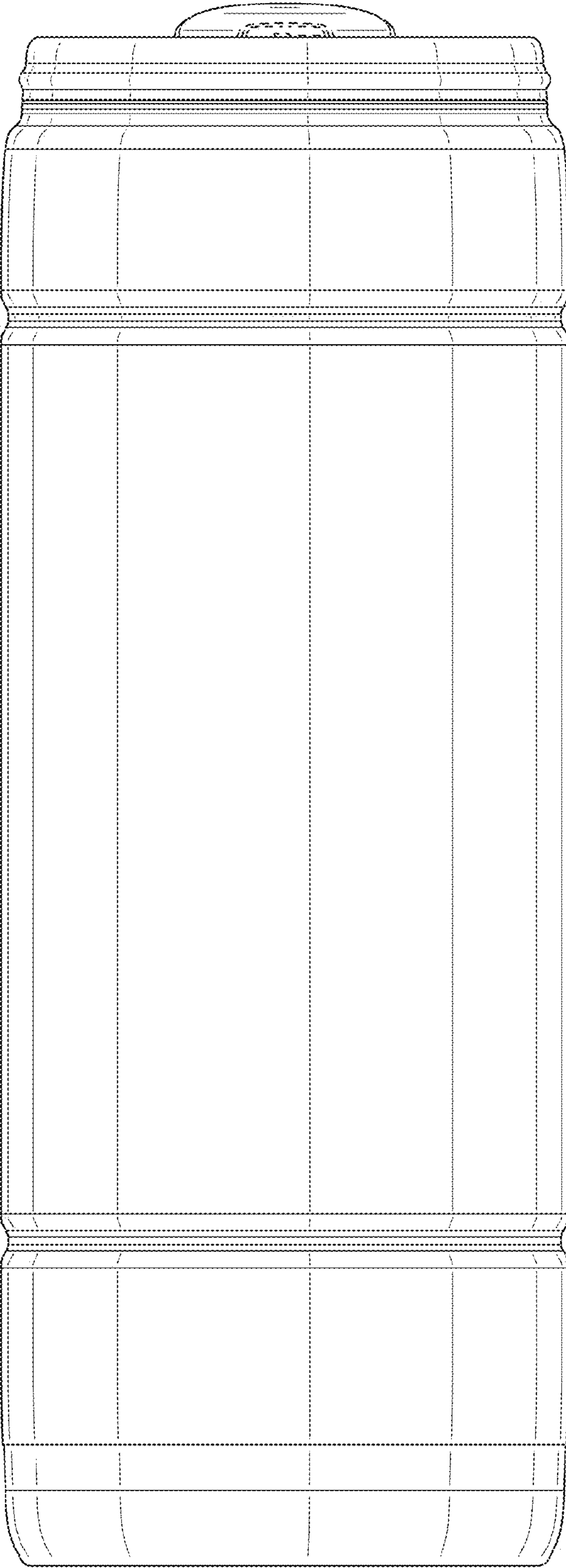

FIG. 9

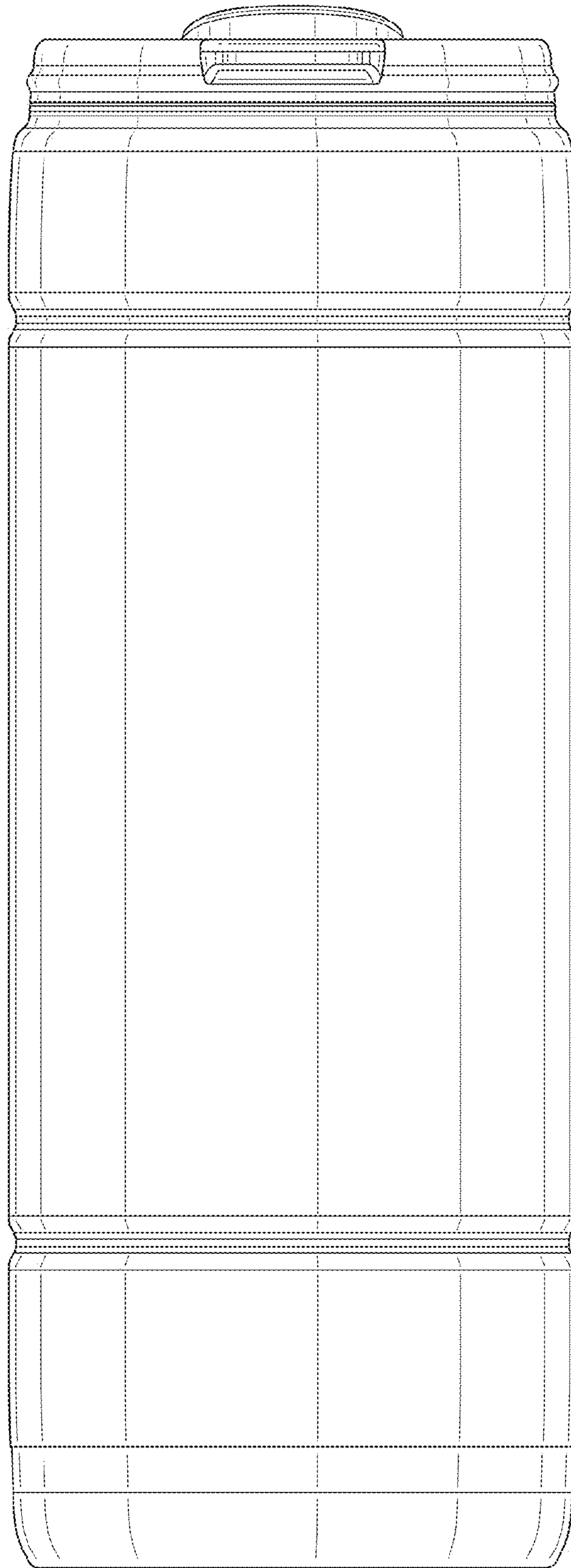

FIG. 10

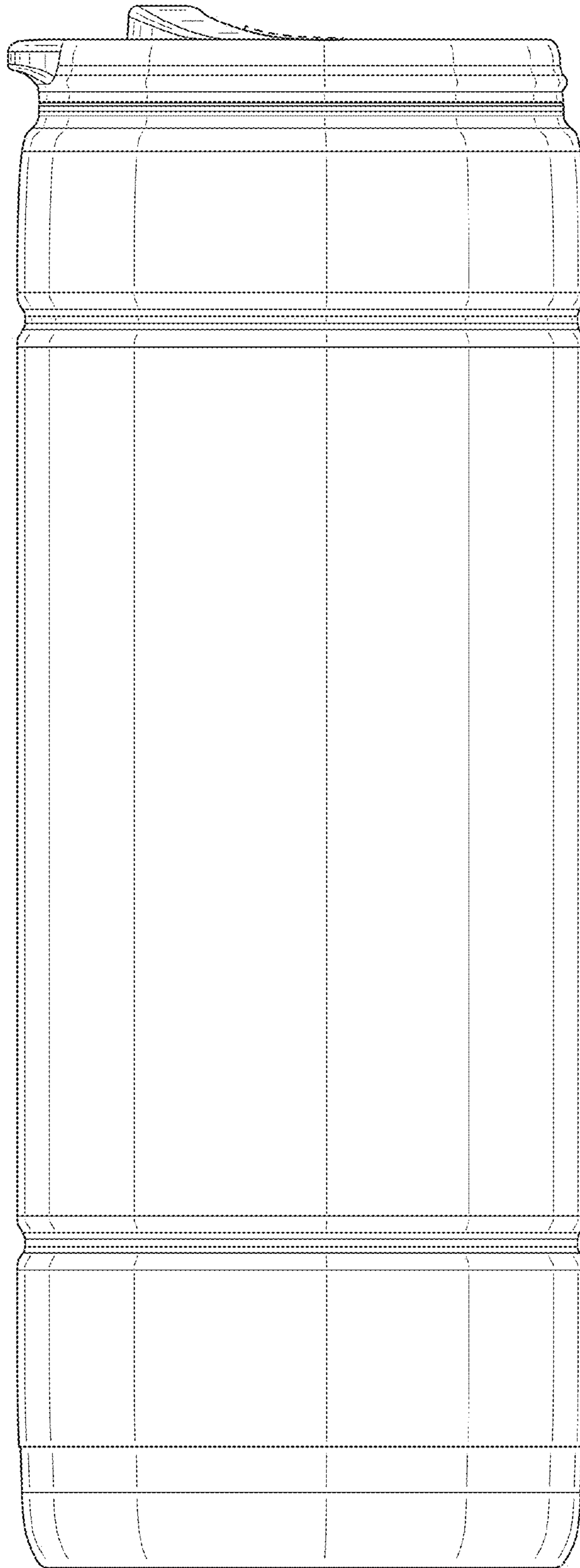

FIG. 11

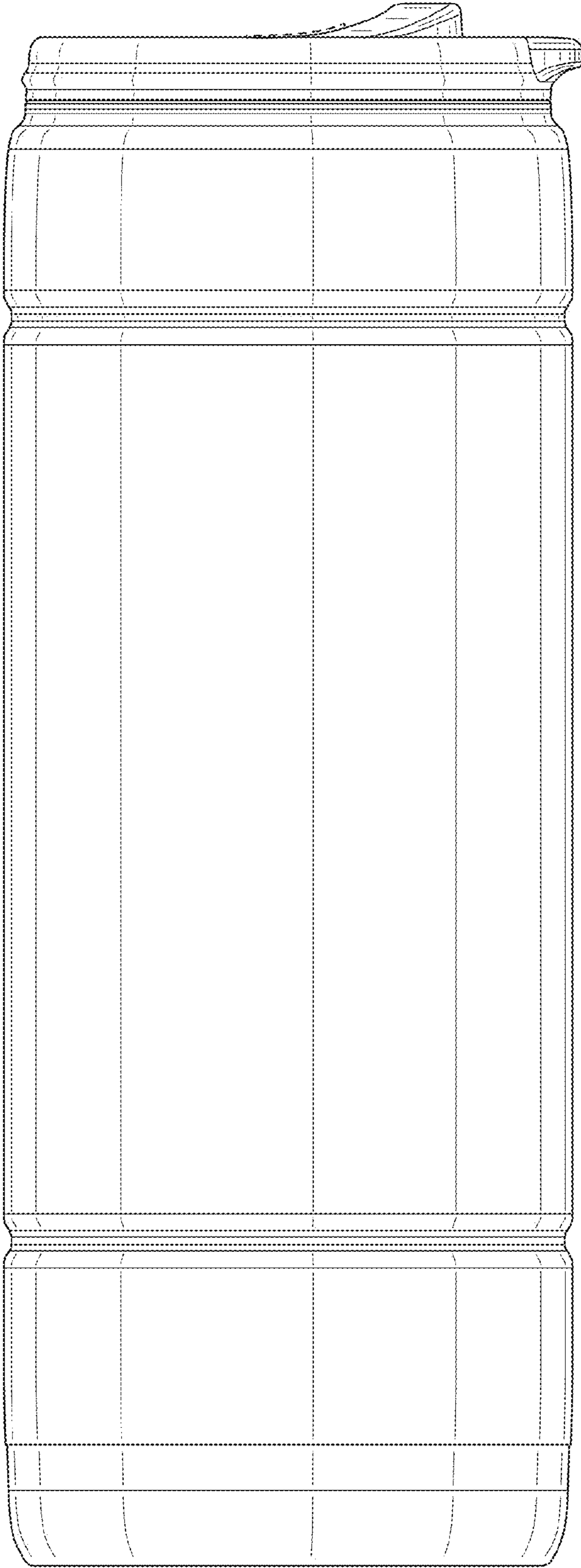

FIG. 12

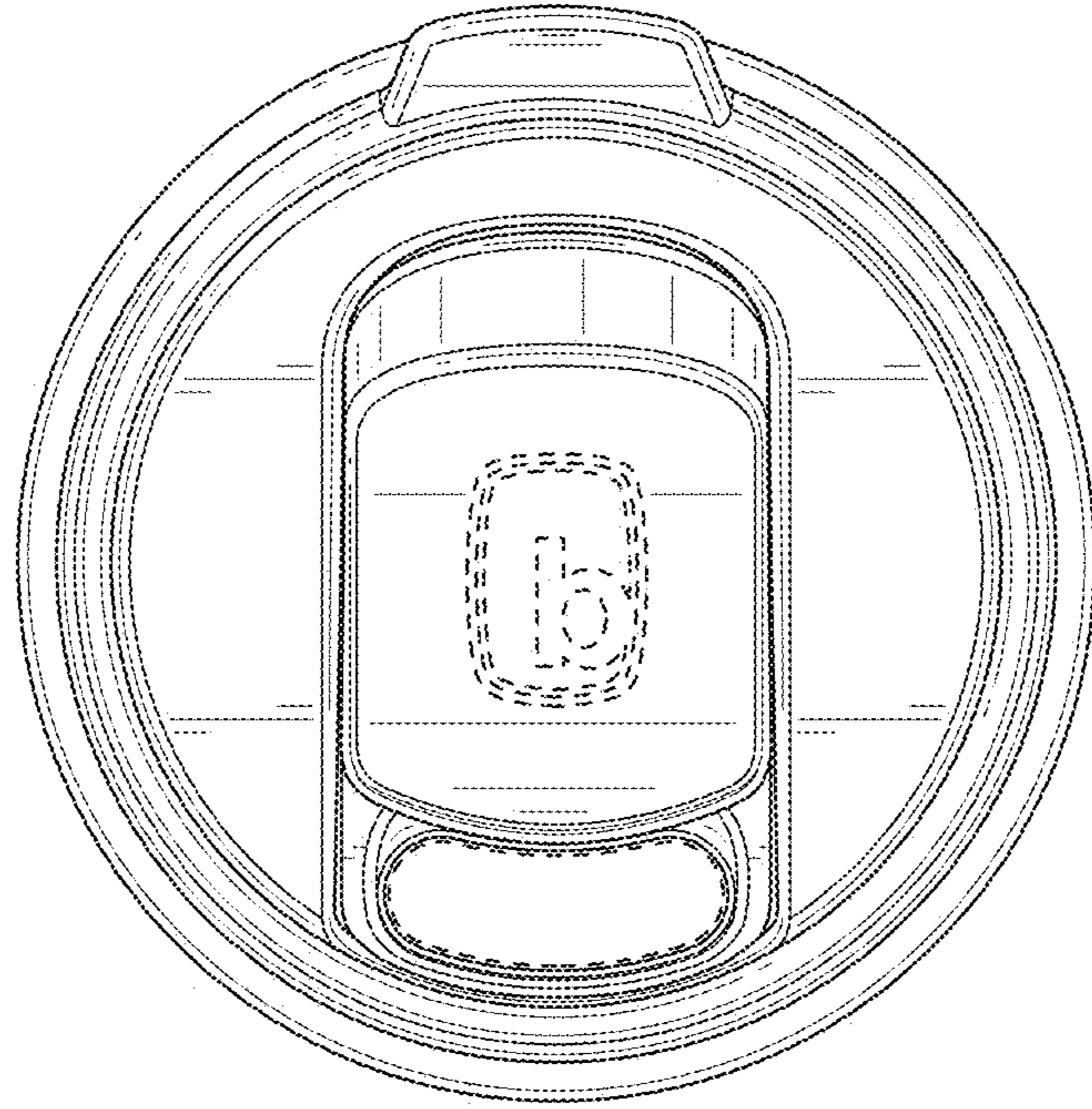

FIG. 13

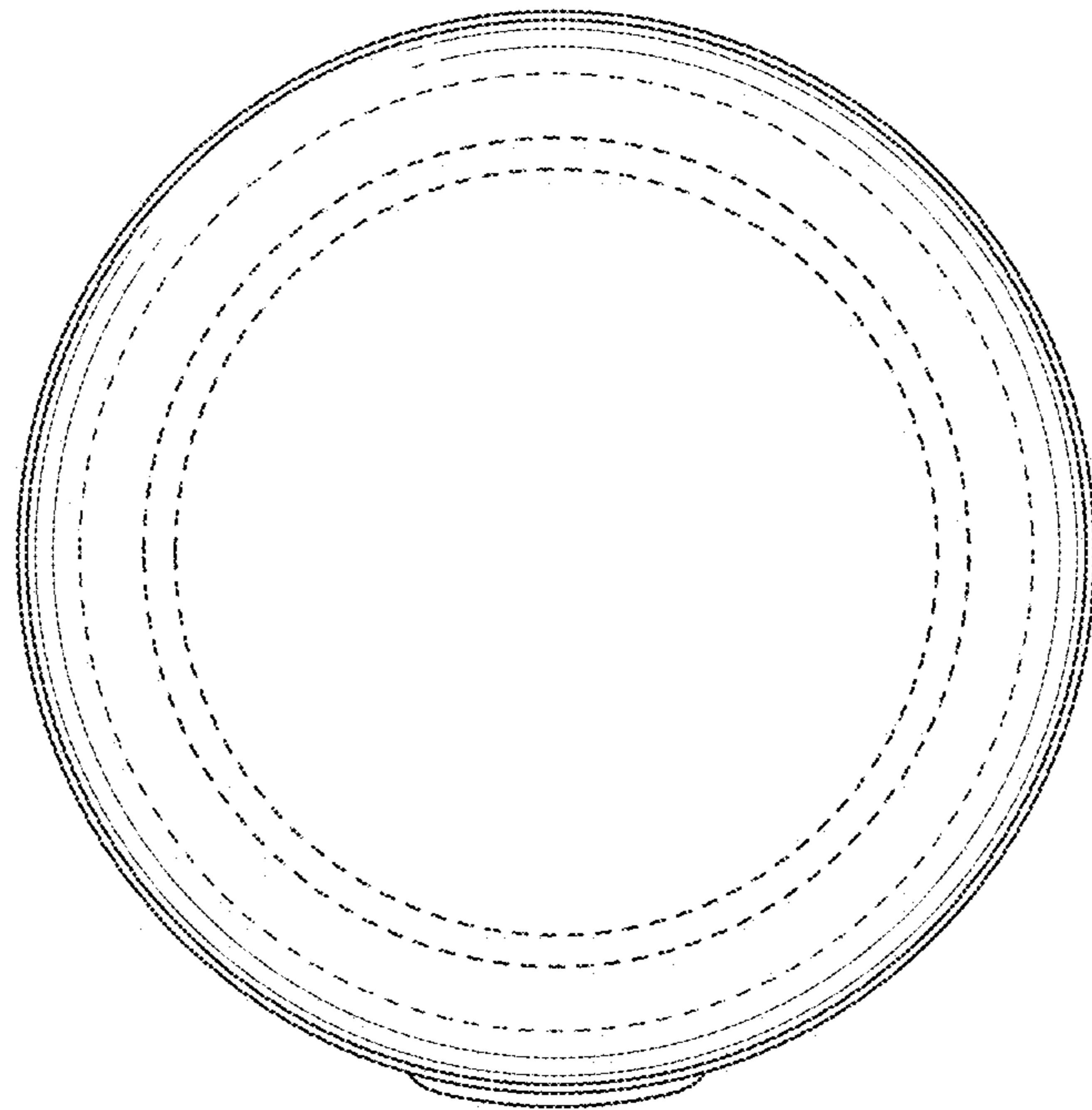

FIG. 14