



US00D984214S

(12) **United States Design Patent**  
**Jacob**

(10) **Patent No.:** **US D984,214 S**

(45) **Date of Patent:** **\*\* Apr. 25, 2023**

(54) **BEVERAGE SYSTEM**

(71) Applicant: **BruMate, INC.**, Denver, CO (US)

(72) Inventor: **Dylan M. Jacob**, Denver, CO (US)

(73) Assignee: **BruMate, Inc.**, Denver, CO (US)

(\*\*) Term: **15 Years**

(21) Appl. No.: **29/741,309**

(22) Filed: **Jul. 10, 2020**

(51) **LOC (14) Cl.** ..... **07-01**

(52) **U.S. Cl.**

USPC ..... **D7/510**; D9/449; D9/560

(58) **Field of Classification Search**

USPC ..... D7/507, 509, 510, 511, 533, 536, 392.1,  
D7/396.1, 396.2, 608, 900; D30/132,

(Continued)

(56) **References Cited**

**U.S. PATENT DOCUMENTS**

D115,343 S \* 6/1939 Burgund ..... D9/566

D289,356 S \* 4/1987 Tanaka ..... D7/523

(Continued)

**FOREIGN PATENT DOCUMENTS**

CN 302482233 \* 6/2013

IN 318552-001-0001 \* 7/2020

(Continued)

**OTHER PUBLICATIONS**

MyBevi [online] URL: <https://www.amazon.com/MyBevi-Stainless-Steel-Tumbler-Black/dp/B07D1925CW> (site visited:May 2, 2022) (Year: 2018).\*

(Continued)

*Primary Examiner* — Jae Liang

*Assistant Examiner* — Tia Ruth-Renee Polidori

(74) *Attorney, Agent, or Firm* — Shook, Hardy & Bacon LLP

(57) **CLAIM**

The ornamental design for a beverage system, as shown and described.

**DESCRIPTION**

FIG. 1 is a front elevation view of my new design for a beverage system, with the lid portion removed for clarity of disclosure;

FIG. 2 is a rear elevation view thereof;

FIG. 3 is a right-side elevation view thereof;

FIG. 4 is a left-side elevation view thereof;

FIG. 5 is a top plan view thereof;

FIG. 6 is a bottom plan view thereof;

FIG. 7 is a top perspective view thereof;

FIG. 8 is a front elevation view of my new design for a beverage system;

FIG. 9 is a rear elevation view thereof;

FIG. 10 is a right-side elevation view thereof;

FIG. 11 is a left-side elevation view thereof;

FIG. 12 is a top plan view thereof;

FIG. 13 is a bottom plan view thereof;

FIG. 14 is a top perspective view thereof;

FIG. 15 is a front elevation view of my new design for a beverage system, with the container portion removed for clarity of disclosure;

FIG. 16 is a rear elevation view thereof;

FIG. 17 is a right-side elevation view thereof;

FIG. 18 is a left-side elevation view thereof;

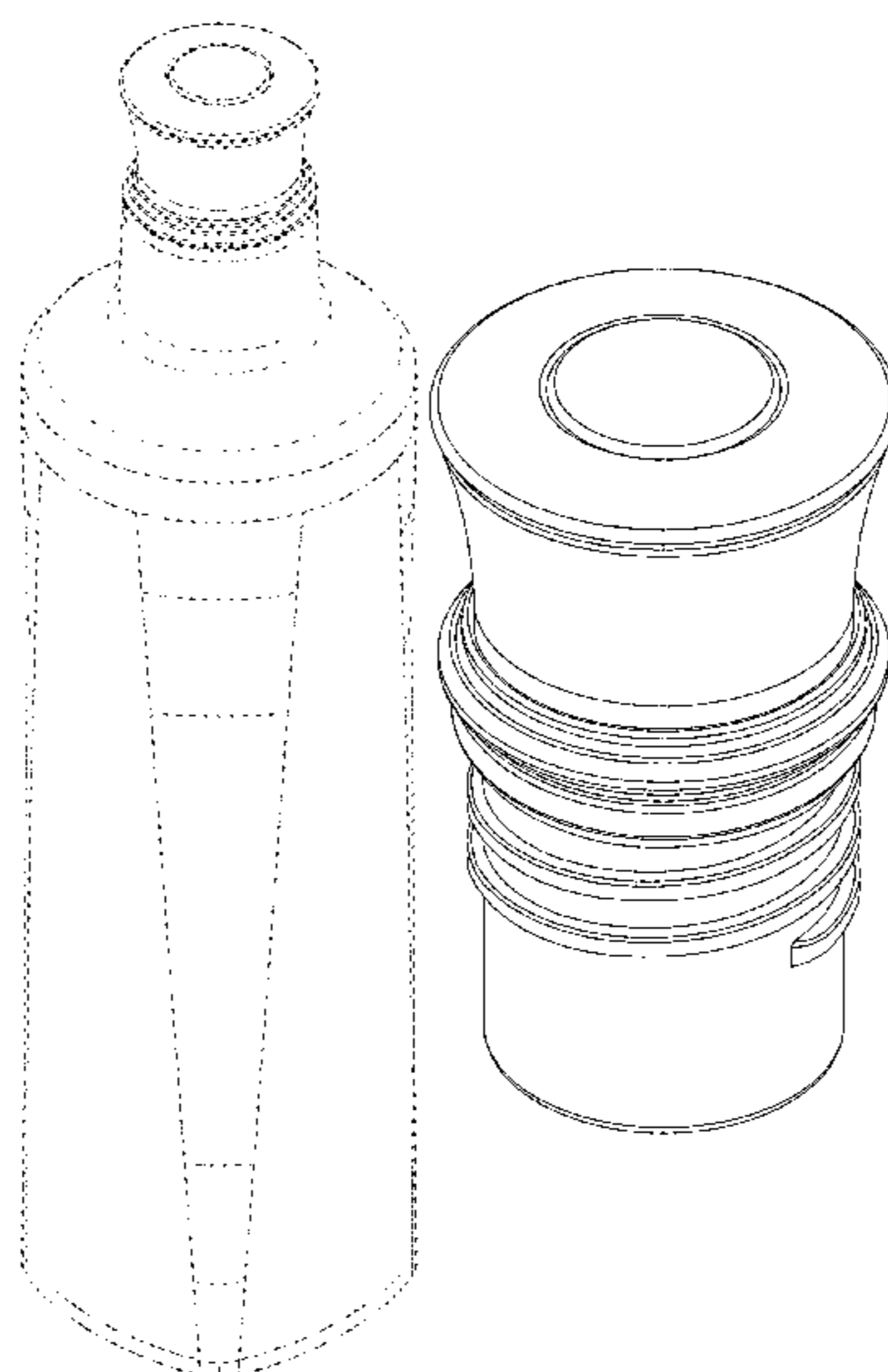
FIG. 19 is a top plan view thereof;

FIG. 20 is a bottom plan view thereof; and,

FIG. 21 is a top perspective view thereof.

The broken lines in the drawing depict portions of the beverage system that form no part of the claimed design. The dot-dash lines indicate boundaries of the claim and form no part of the claimed design.

**1 Claim, 20 Drawing Sheets**



(58) **Field of Classification Search**

USPC ..... D30/121, 122, 123, 124, 125, 126, 127,  
D30/128, 129, 130, 131, 133; D9/443,  
D9/449, 561, 500, 503, 504, 615, 560;  
D3/202; D29/125, 126  
CPC ..... A47G 19/2205; A47G 23/16; A47G  
19/2272; A47J 41/00; A47J 41/02; A47J  
41/0077; Y10S 220/903; B65D 21/02;  
B65D 43/00; B65D 41/00

See application file for complete search history.

(56) **References Cited**

U.S. PATENT DOCUMENTS

D309,567 S \* 7/1990 Desgrippes ..... D9/566  
D333,196 S \* 2/1993 Dzierisk ..... D34/1  
D400,797 S \* 11/1998 de Mourgues ..... D9/558  
D411,460 S \* 6/1999 Nobuto ..... D9/566  
D419,071 S \* 1/2000 Peters ..... D9/449  
D419,447 S \* 1/2000 Molloy ..... D9/449  
D424,442 S \* 5/2000 Kreiseder ..... D9/449  
D435,793 S \* 1/2001 Kreiseder ..... D9/449  
D438,114 S \* 2/2001 Stonberg ..... D9/449  
6,457,602 B2 \* 10/2002 Uchiyama ..... G03D 3/06  
220/675  
D483,981 S \* 12/2003 Linz ..... D7/300.1  
D490,315 S \* 5/2004 Kiser ..... D9/437  
D500,681 S \* 1/2005 Uchiyama ..... D9/560  
D503,886 S \* 4/2005 Biesecker ..... D9/453  
D504,066 S \* 4/2005 King ..... D9/453  
D565,421 S \* 4/2008 De Baschmakoff ..... D9/558  
D573,893 S \* 7/2008 Moretti ..... D9/560  
D584,631 S \* 1/2009 Van Well ..... D9/546  
D589,362 S \* 3/2009 Takounseun ..... D9/691  
D659,472 S \* 5/2012 D'Amato ..... D7/509  
D682,088 S \* 5/2013 de Urquijo Carmona .... D9/428  
D691,484 S \* 10/2013 Fitzgerald ..... D9/560  
D693,694 S \* 11/2013 Makhsudova ..... D9/571  
D694,640 S \* 12/2013 Infahsaeng ..... D9/569  
D694,641 S \* 12/2013 Infahsaeng ..... D9/569  
D694,642 S \* 12/2013 Infahsaeng ..... D9/569  
D736,562 S \* 8/2015 Green ..... D7/510  
D748,485 S \* 2/2016 Marret ..... D9/560  
D751,894 S \* 3/2016 Nordenskjöld ..... D9/431  
D757,559 S \* 5/2016 Sanghavi ..... D9/571  
D801,180 S \* 10/2017 Jacobsson ..... D9/566  
D809,389 S \* 2/2018 Royer ..... D9/454

D810,582 S \* 2/2018 Lee ..... D9/682  
D828,175 S \* 9/2018 Furneaux ..... D9/504  
D833,889 S \* 11/2018 Hurst ..... D9/566  
D839,050 S \* 1/2019 Sibbert ..... D9/503  
D849,550 S \* 5/2019 Dammers ..... D9/560  
D853,246 S \* 7/2019 Dammers ..... D9/560  
D859,999 S \* 9/2019 Mendelson ..... D9/694  
D863,970 S \* 10/2019 Dammers ..... D9/560  
D891,868 S \* 8/2020 Karl, IV ..... D7/532  
D917,295 S \* 4/2021 Del Bon ..... D9/520  
D938,280 S \* 12/2021 Van Skaik ..... D9/566  
11,225,363 B2 \* 1/2022 Guduru ..... B65D 51/24  
D948,284 S \* 4/2022 Bruner ..... D7/510  
D954,556 S \* 6/2022 Ajluni ..... D9/503  
D957,884 S \* 7/2022 Jacob ..... D7/510  
D958,602 S \* 7/2022 Jacob ..... D7/536  
D959,915 S \* 8/2022 Bruner ..... D7/511  
D959,923 S \* 8/2022 Jacob ..... D7/608  
2002/0036176 A1 \* 3/2002 Hughes ..... C02F 1/003  
210/473  
2003/0155321 A1 \* 8/2003 Bauer ..... B65D 51/20  
215/253  
2007/0076064 A1 \* 4/2007 Wang ..... B41J 2/17523  
347/86  
2014/0224797 A1 \* 8/2014 Maloney ..... B65D 47/243  
220/212  
2021/0177127 A1 \* 6/2021 Dahan ..... C02F 1/68

FOREIGN PATENT DOCUMENTS

PH 3-2005-712-0001 \* 11/2006  
RU 00128608 \* 11/2021  
WO WOD093844-005 \* 12/2016

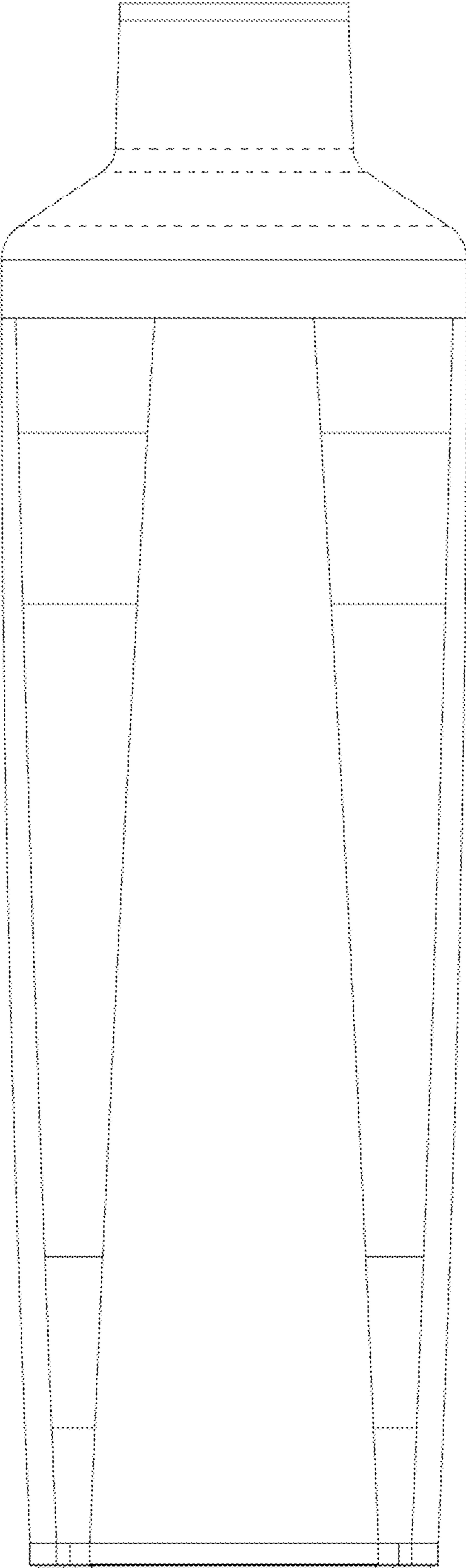
OTHER PUBLICATIONS

Brumate [online] URL: [https://brumate.com/products/brumate-fifth-25oz-liquor-canteen-matte-black?gclid=EAAlQobChMIhvvF8bTB9wIVaCqzAB0cAgPZEAsYASABEgKYwPD\\_BwE](https://brumate.com/products/brumate-fifth-25oz-liquor-canteen-matte-black?gclid=EAAlQobChMIhvvF8bTB9wIVaCqzAB0cAgPZEAsYASABEgKYwPD_BwE) (site visited:May 2, 2022) (Year: 2020).\*

Brumate—Amazon [online] URL: <https://www.amazon.com/-/es/Briimate-Coctelera-inoxidable-aislamiento-transparente/dp/B08N1NGTQ2> (site visited:May 2, 2022) (Year: 2020).\*

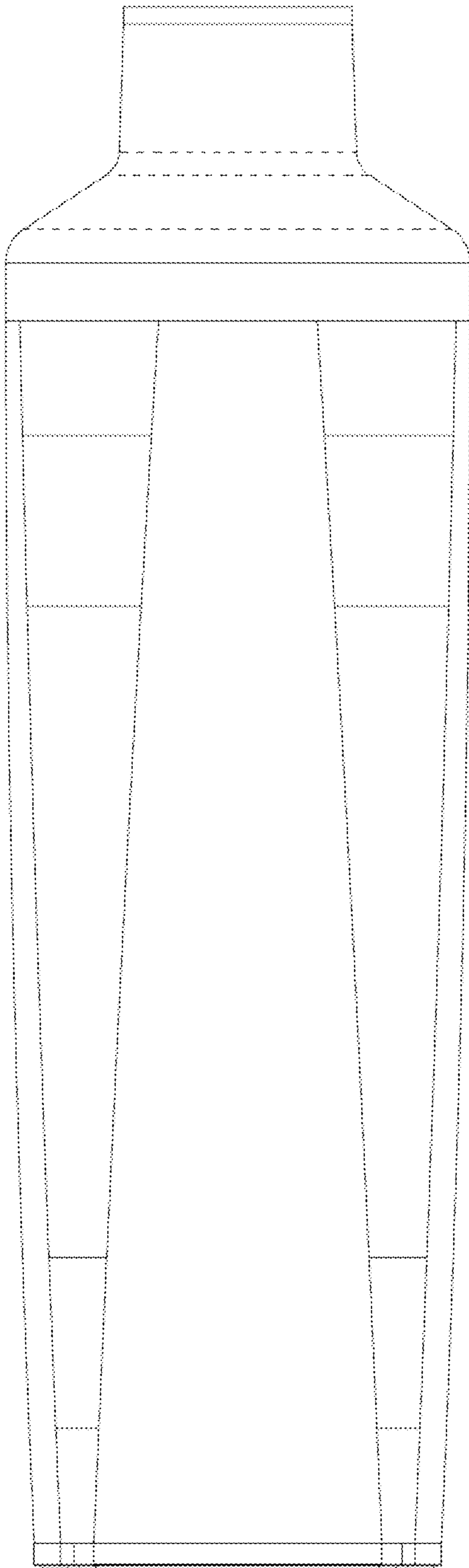
Corkcicle [online] URL: <https://www.amazon.com/Corkcicle-Collection-Water-Thermos-Triple-Insulated-Shatterproof/dp/B01GG0CDZW> (site visited:May 2, 2022) (Year: 2021).\*

\* cited by examiner

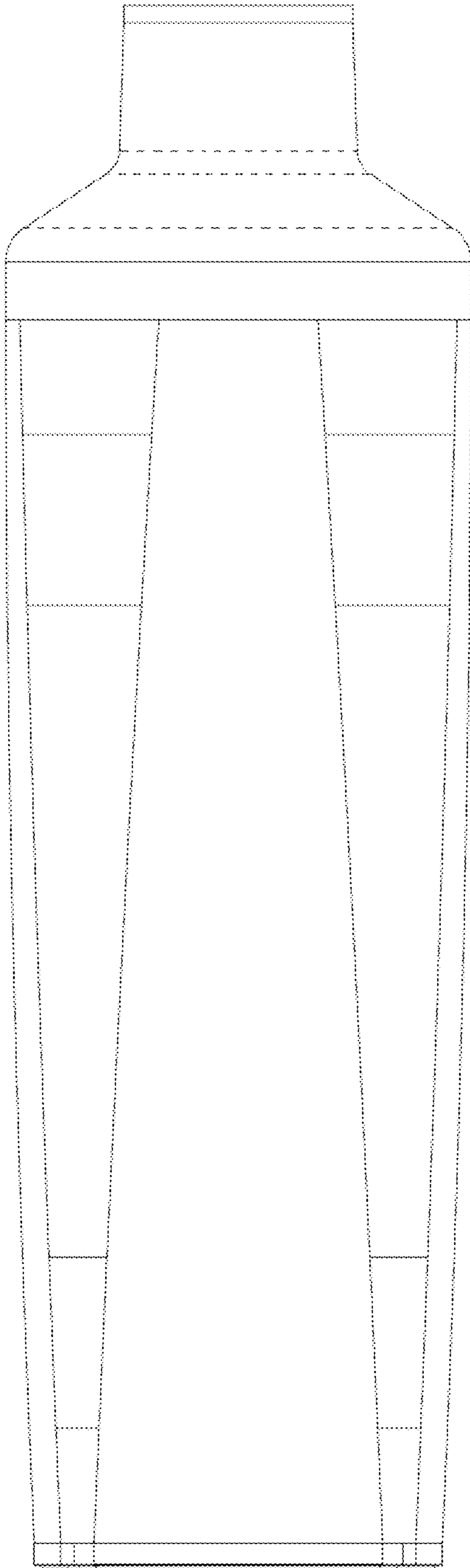


**FIG. 1**

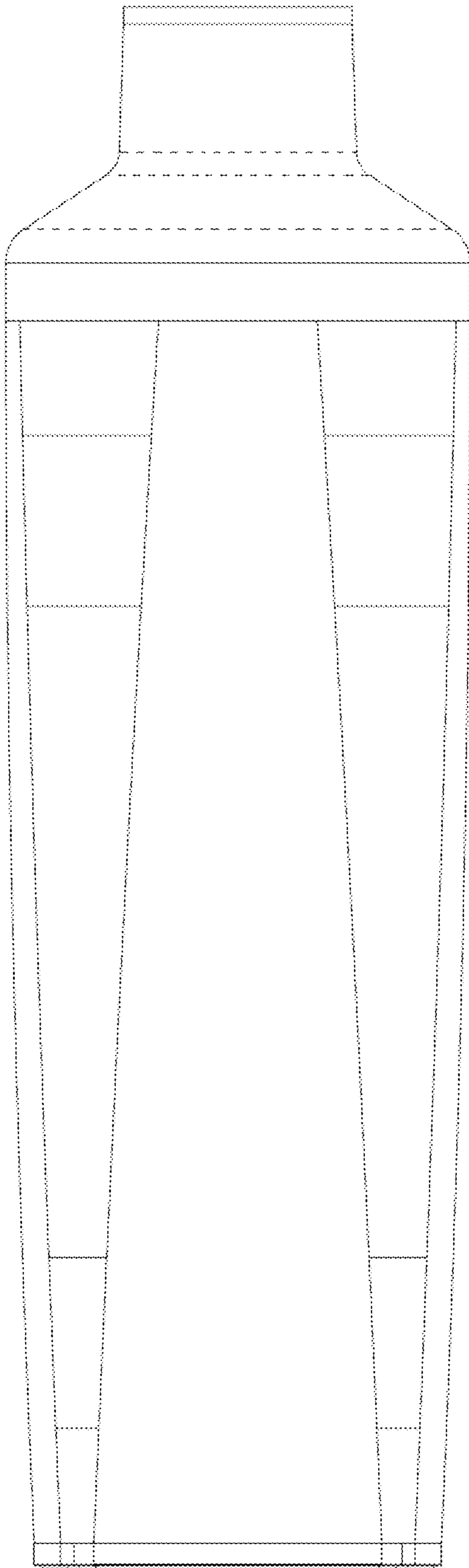




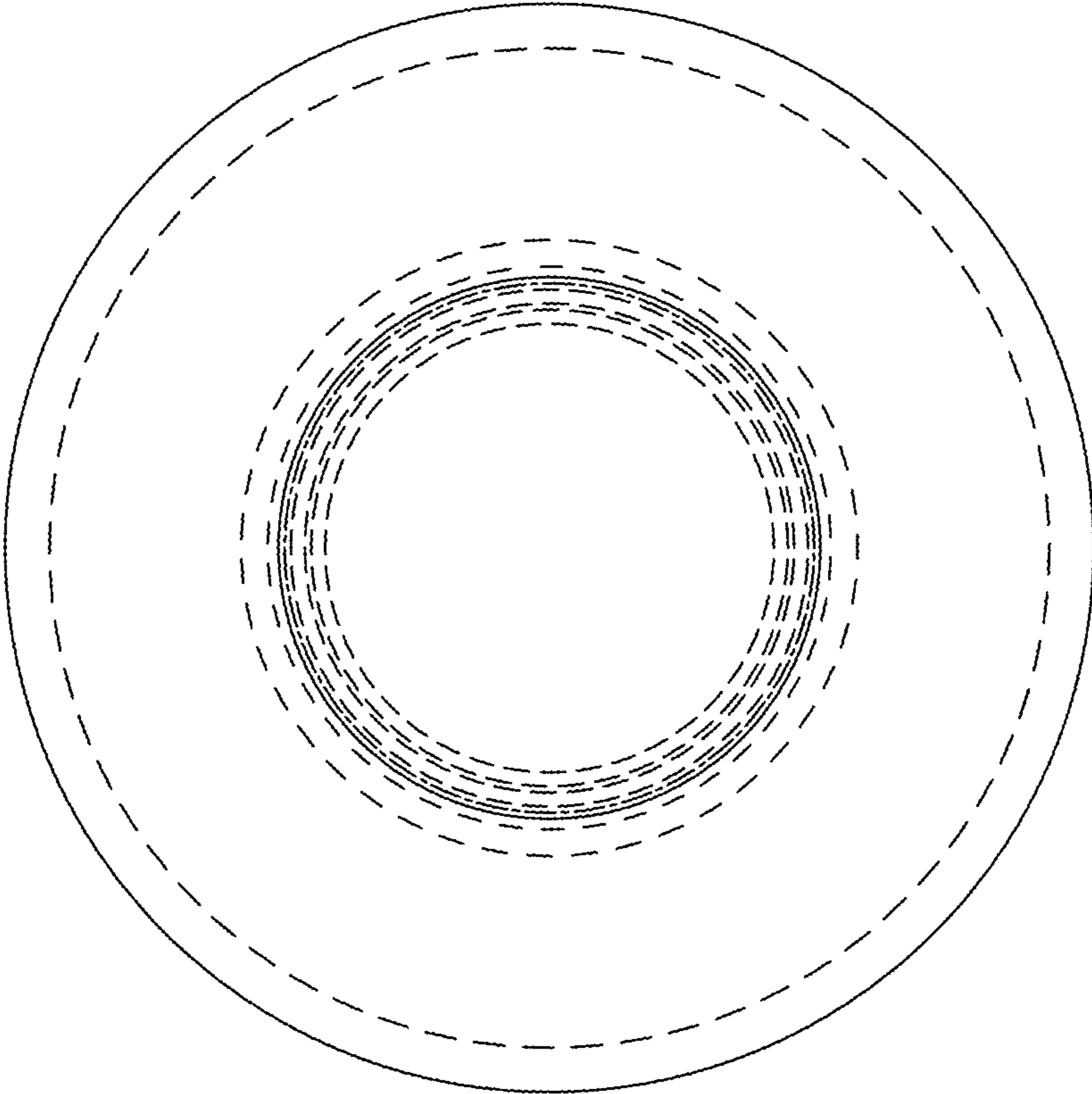
**FIG. 2**



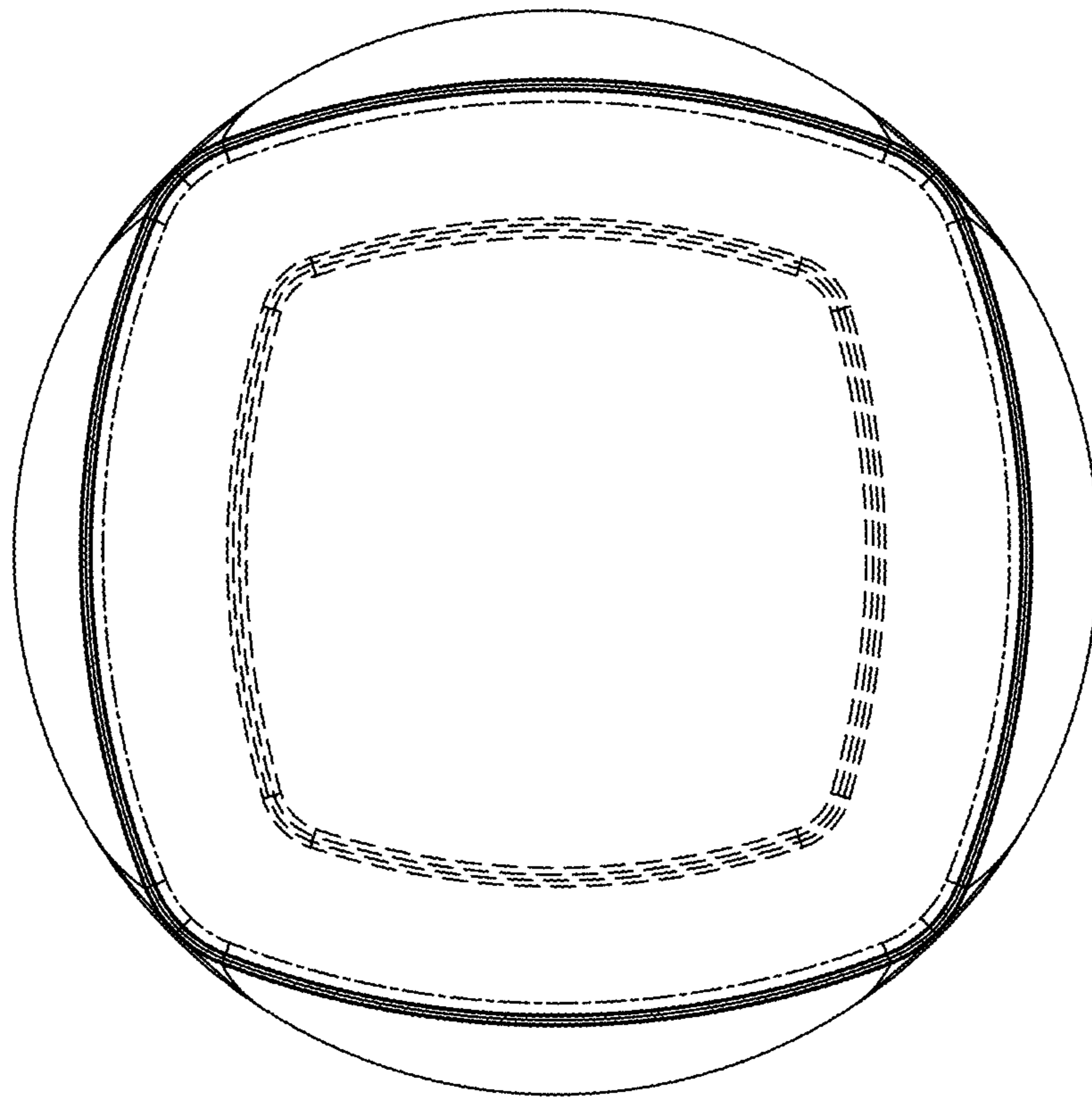
**FIG. 3**



**FIG. 4**

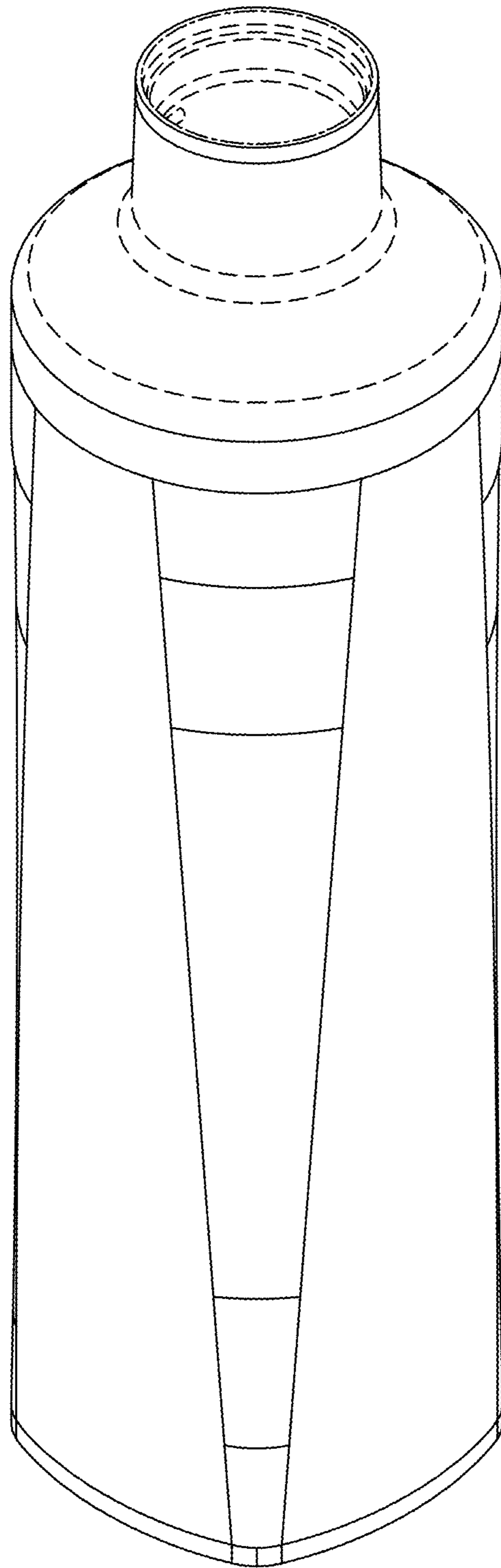


**FIG. 5**

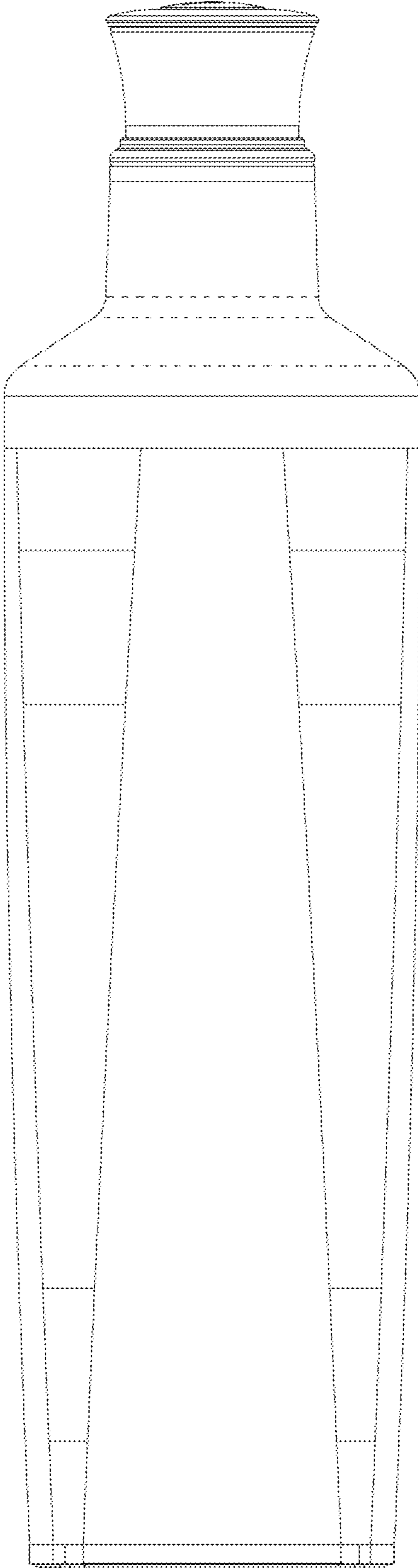


**FIG. 6**

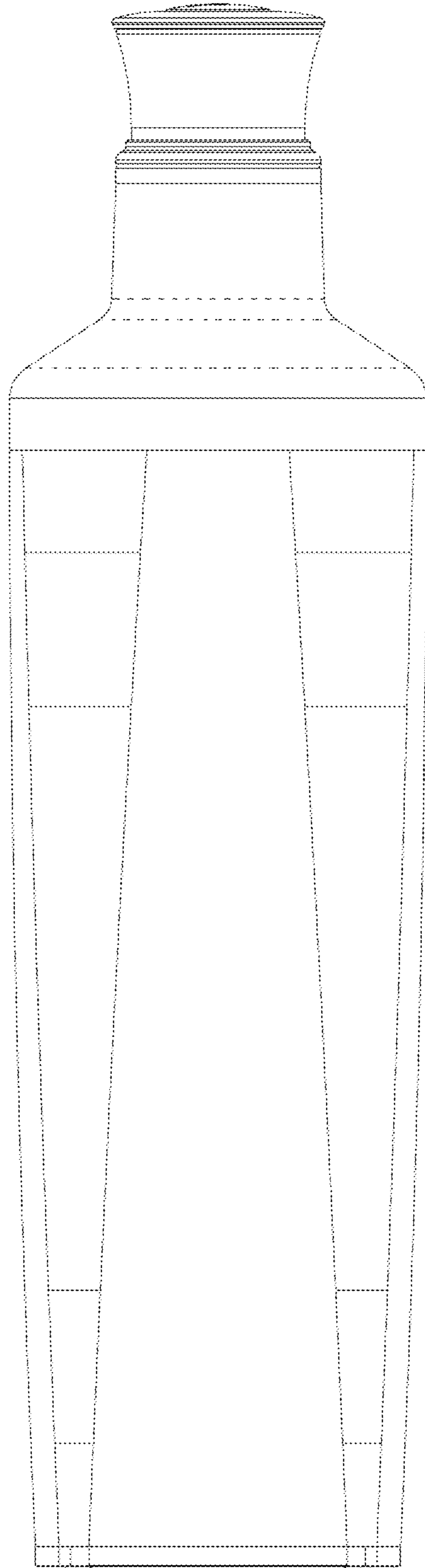




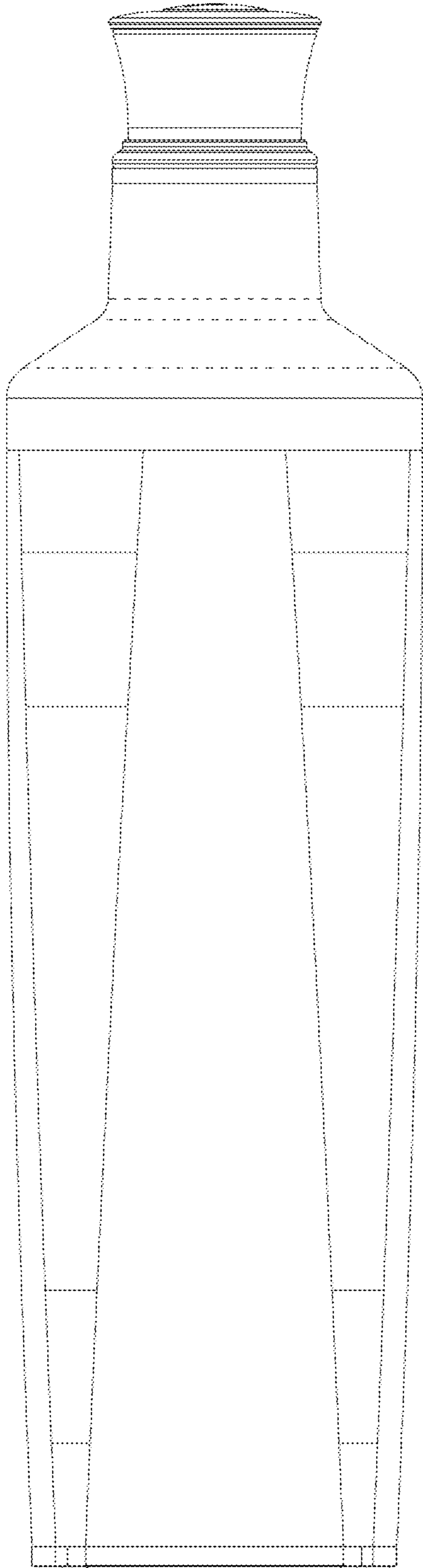
**FIG. 7**



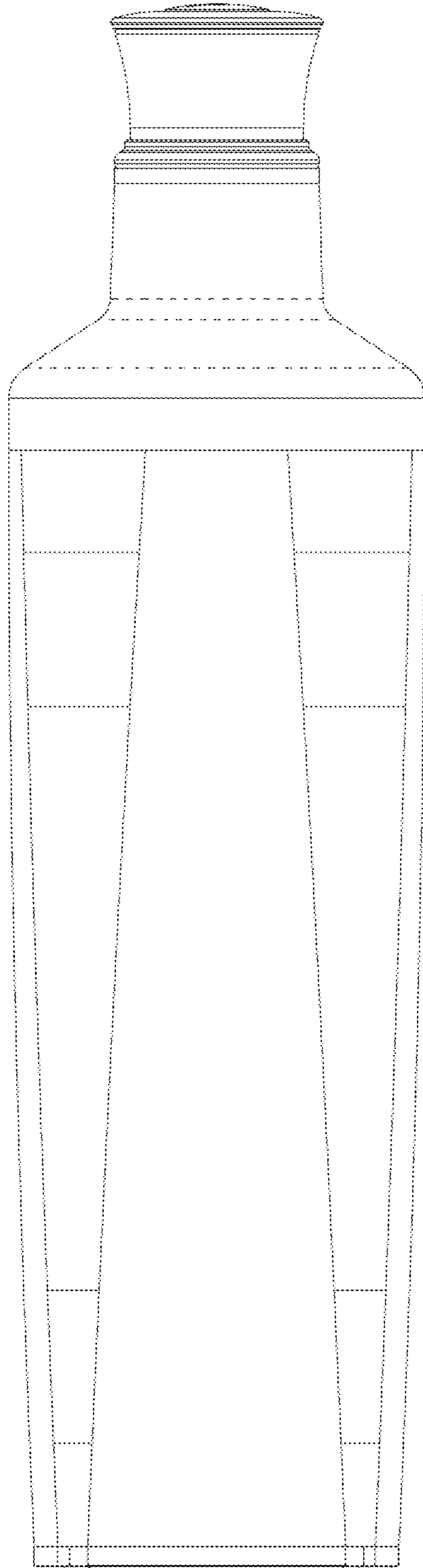
**FIG. 8**



**FIG. 9**

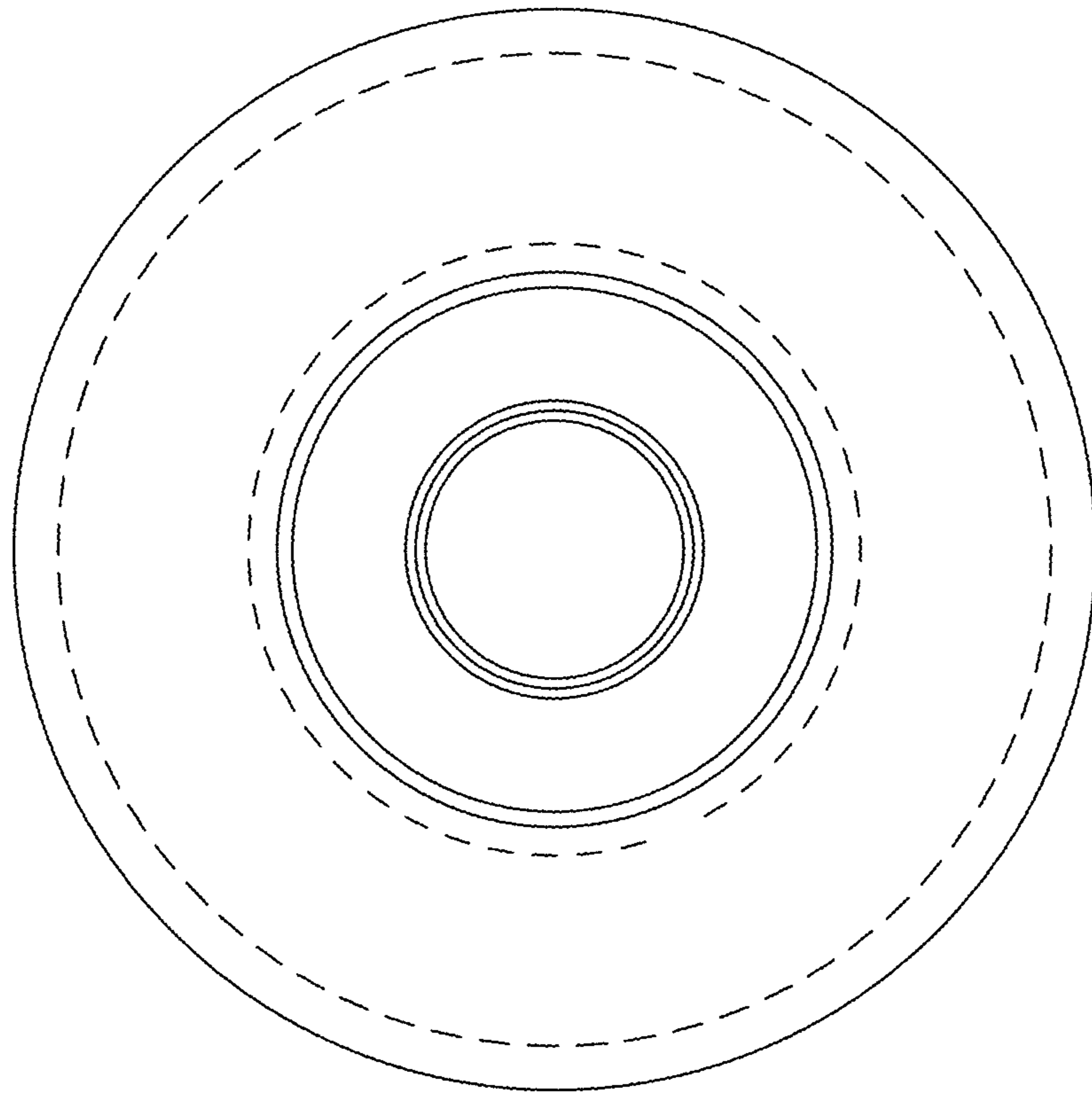


**FIG. 10**

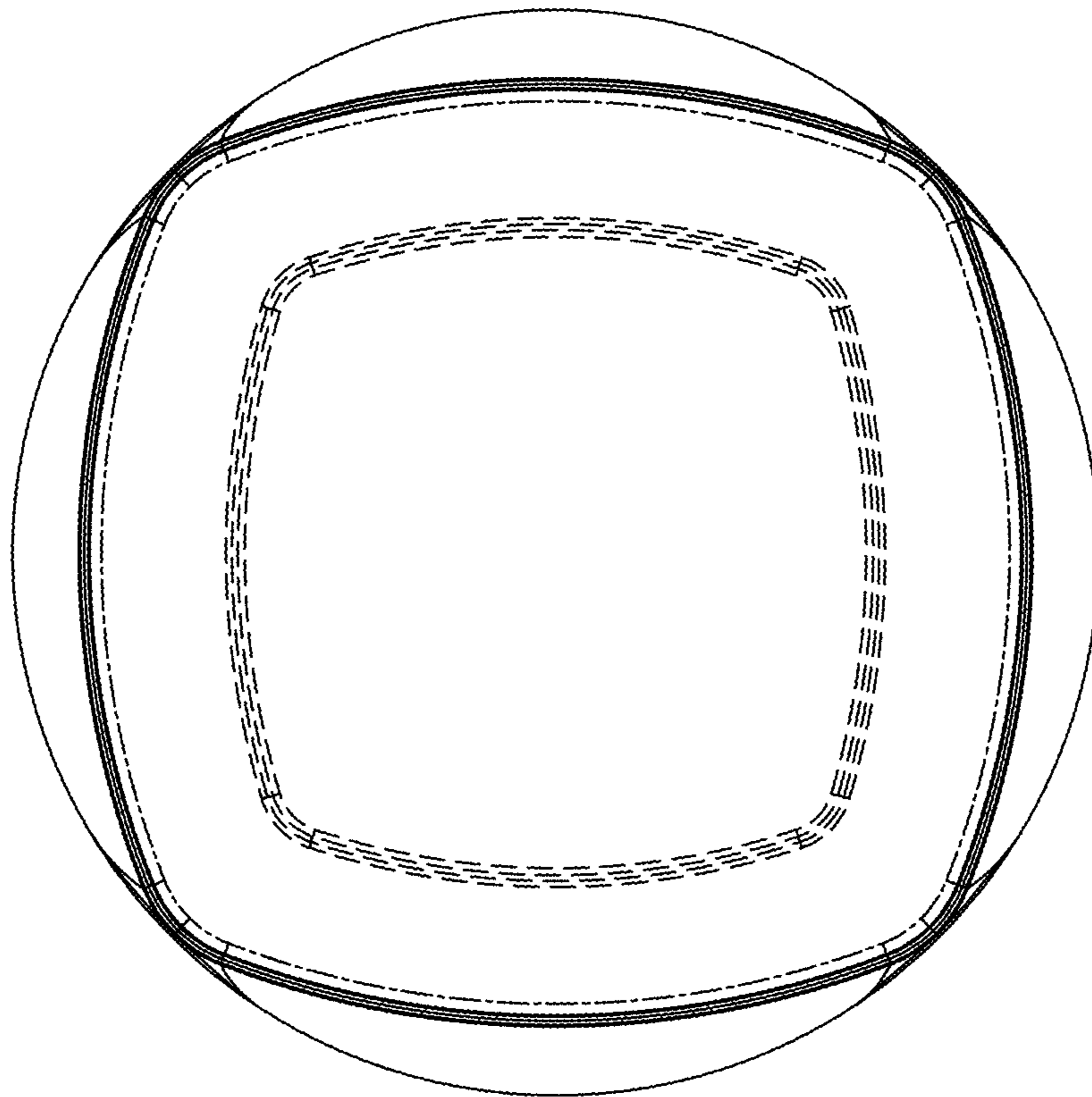


**FIG. 11**

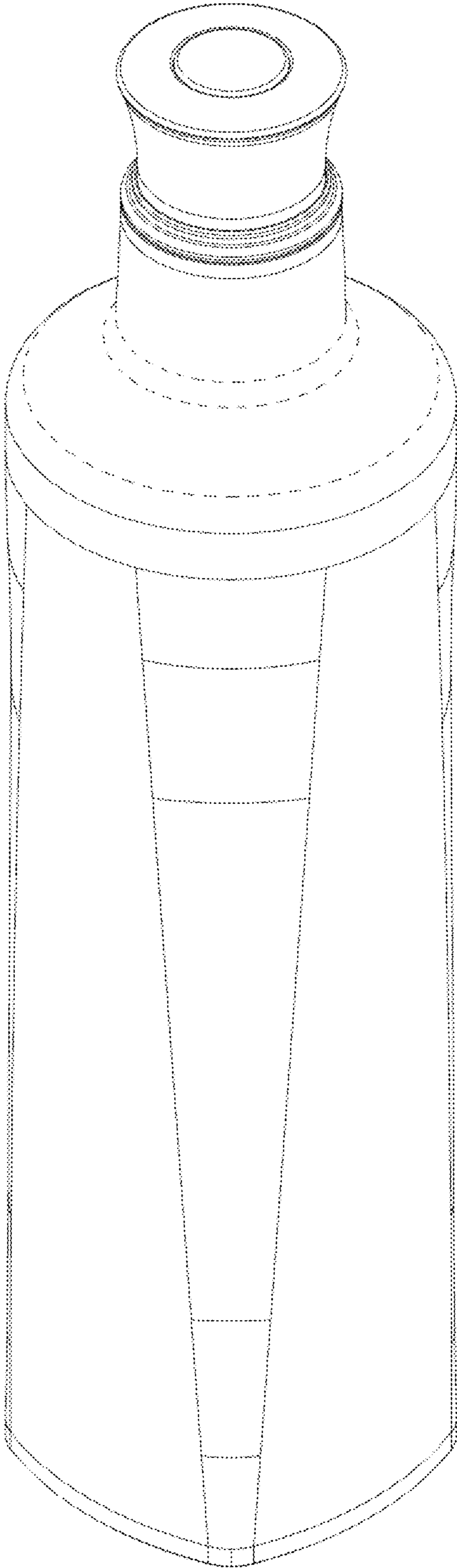




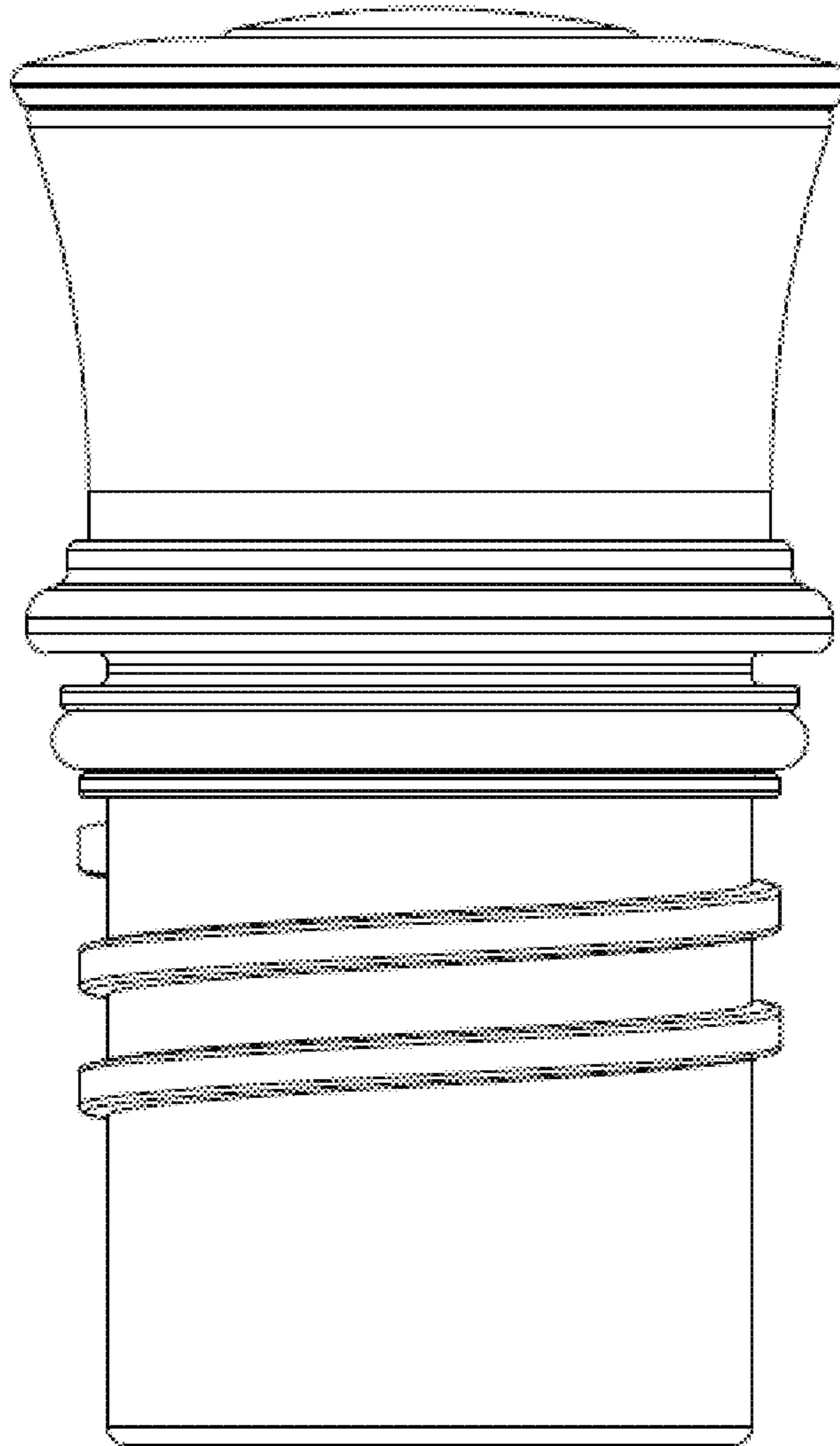
**FIG. 12**



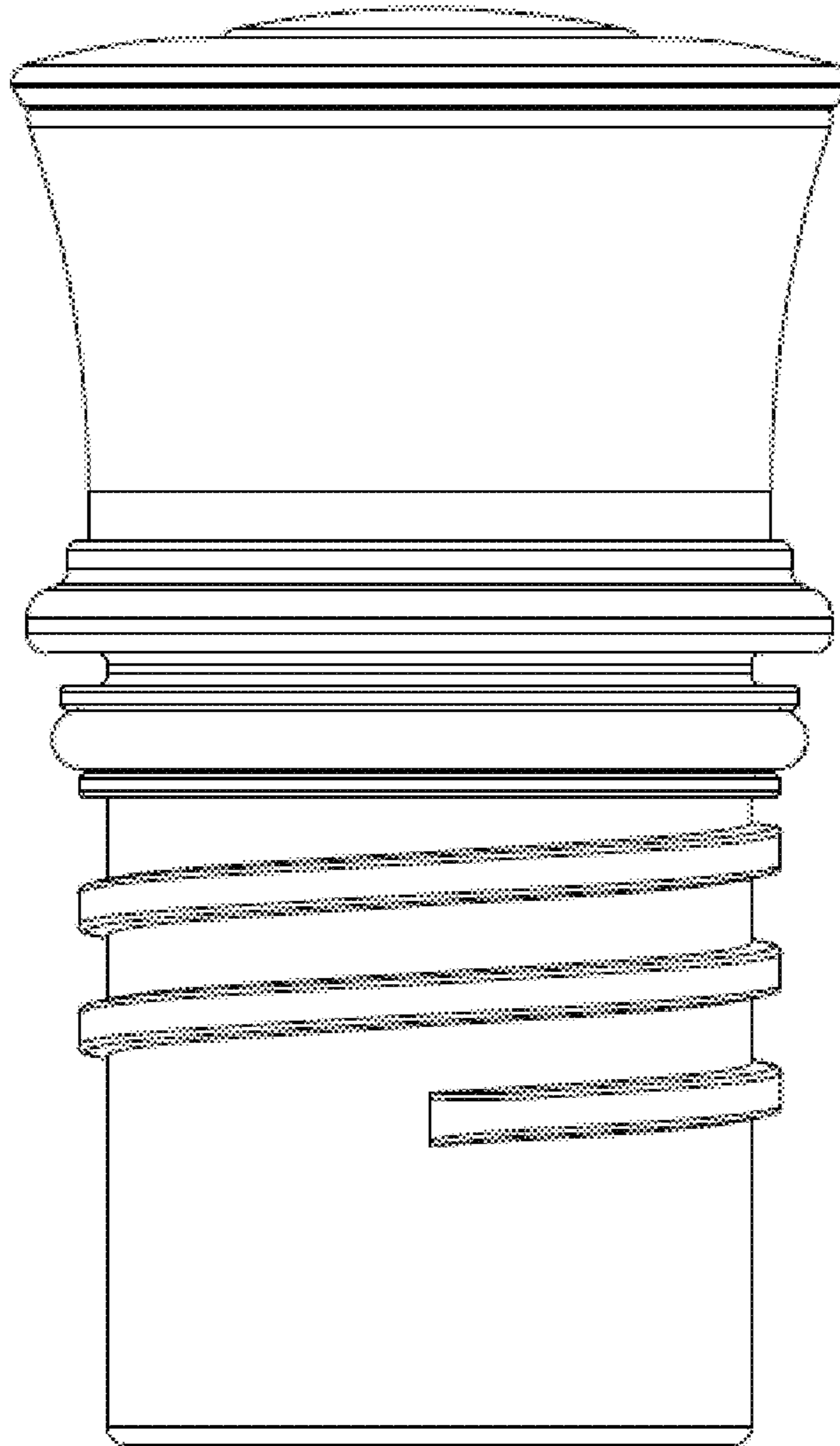
**FIG. 13**



**FIG. 14**

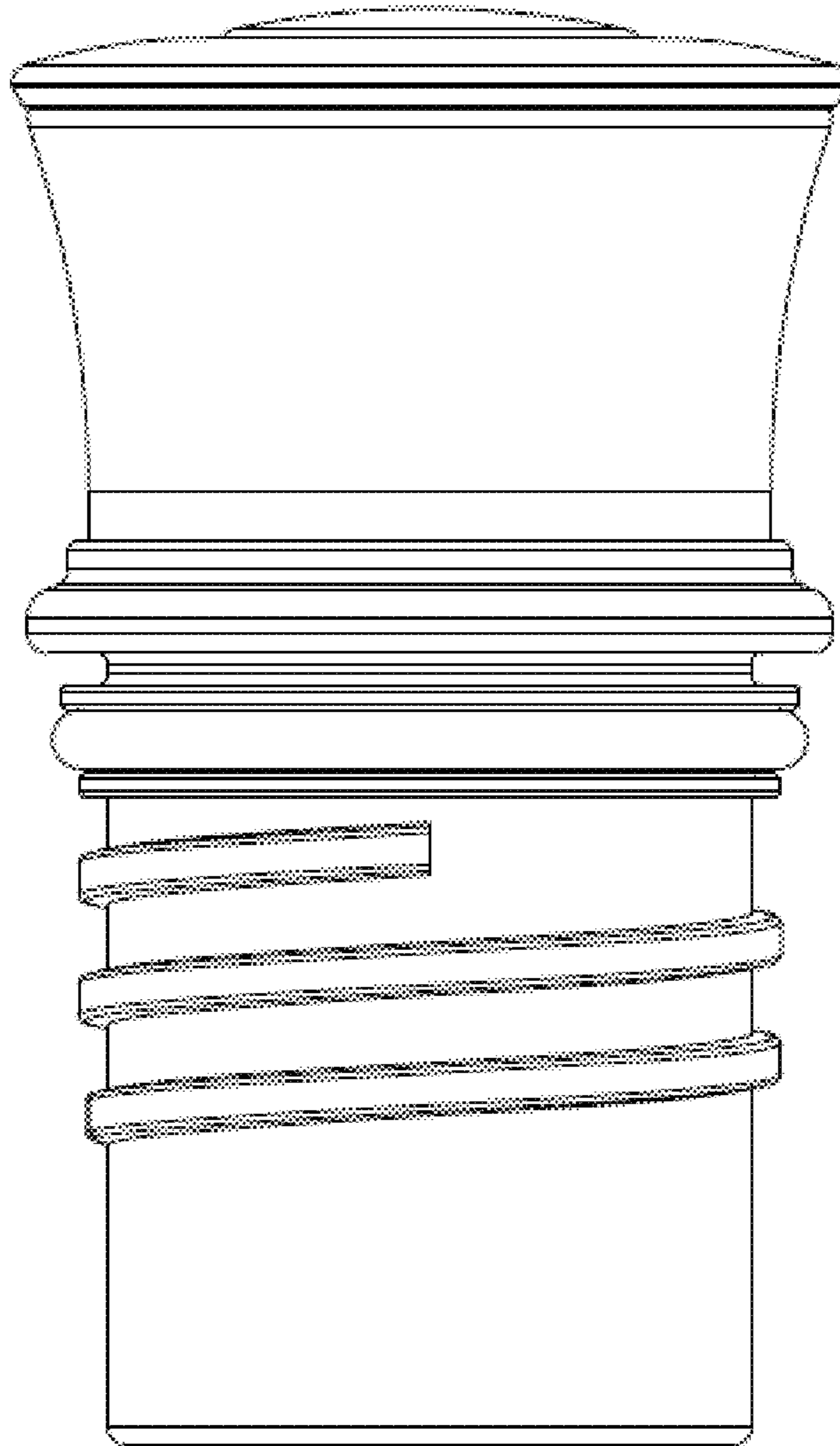


**FIG. 15**

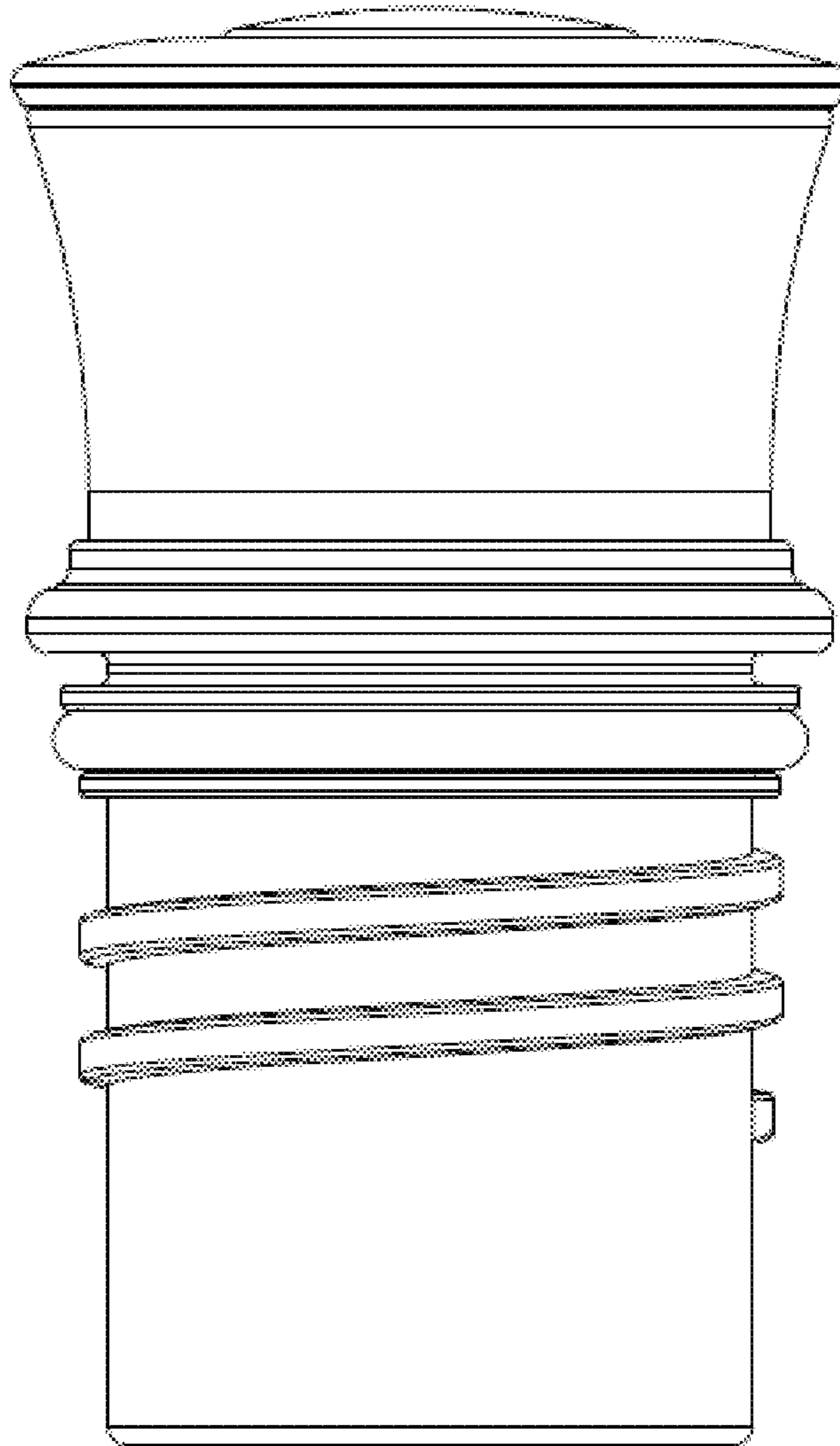


**FIG. 16**

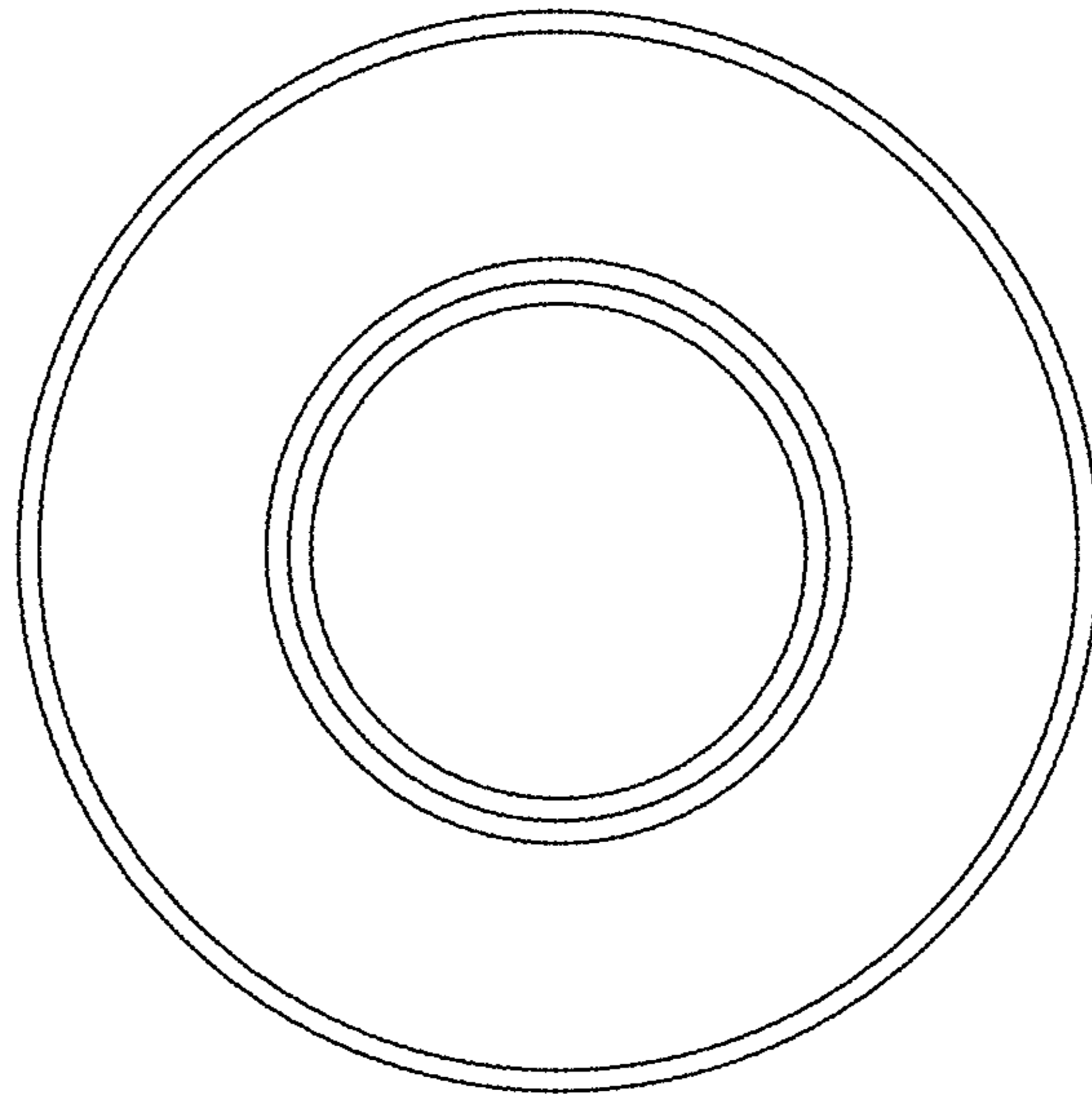




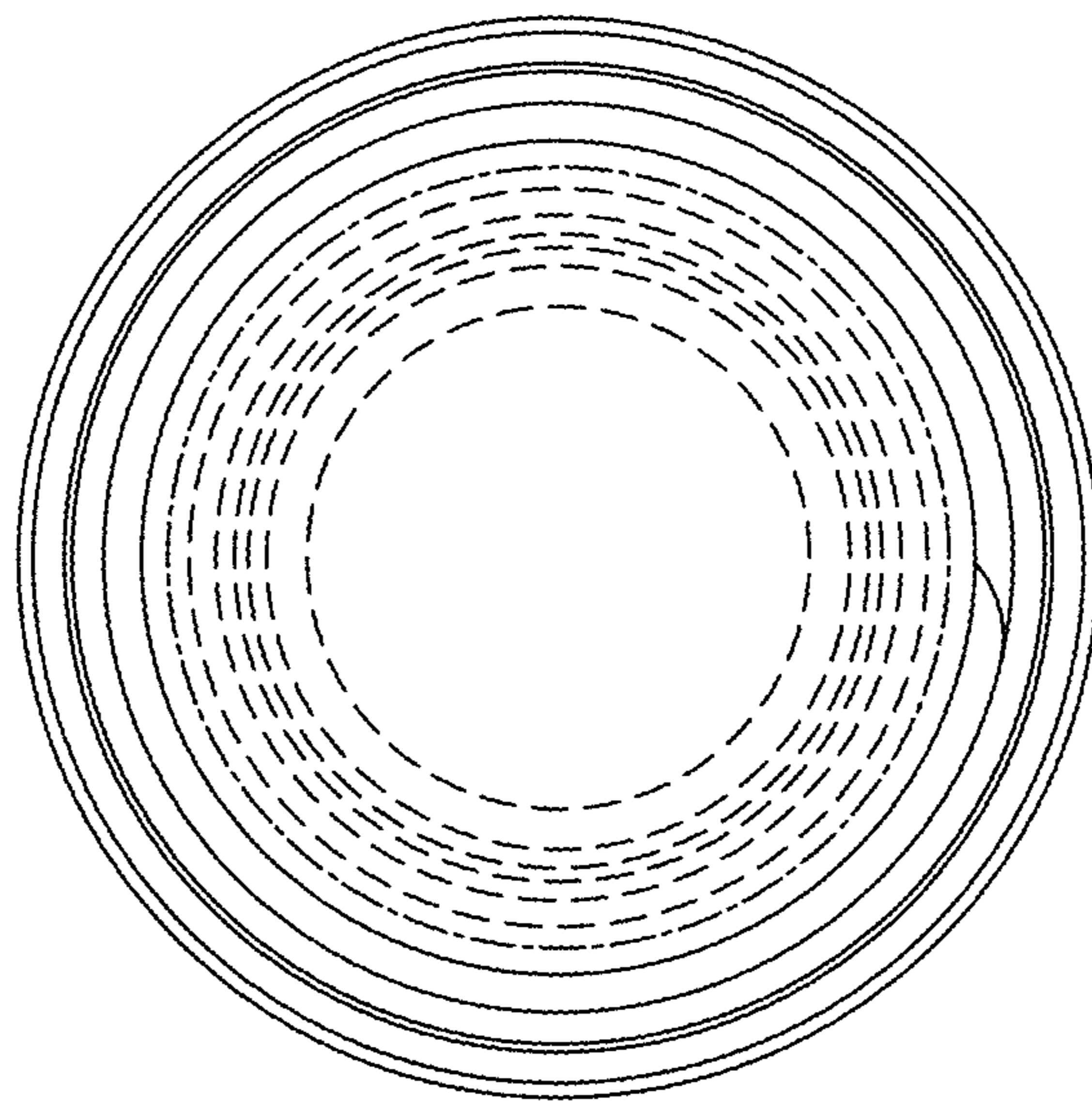
**FIG. 17**



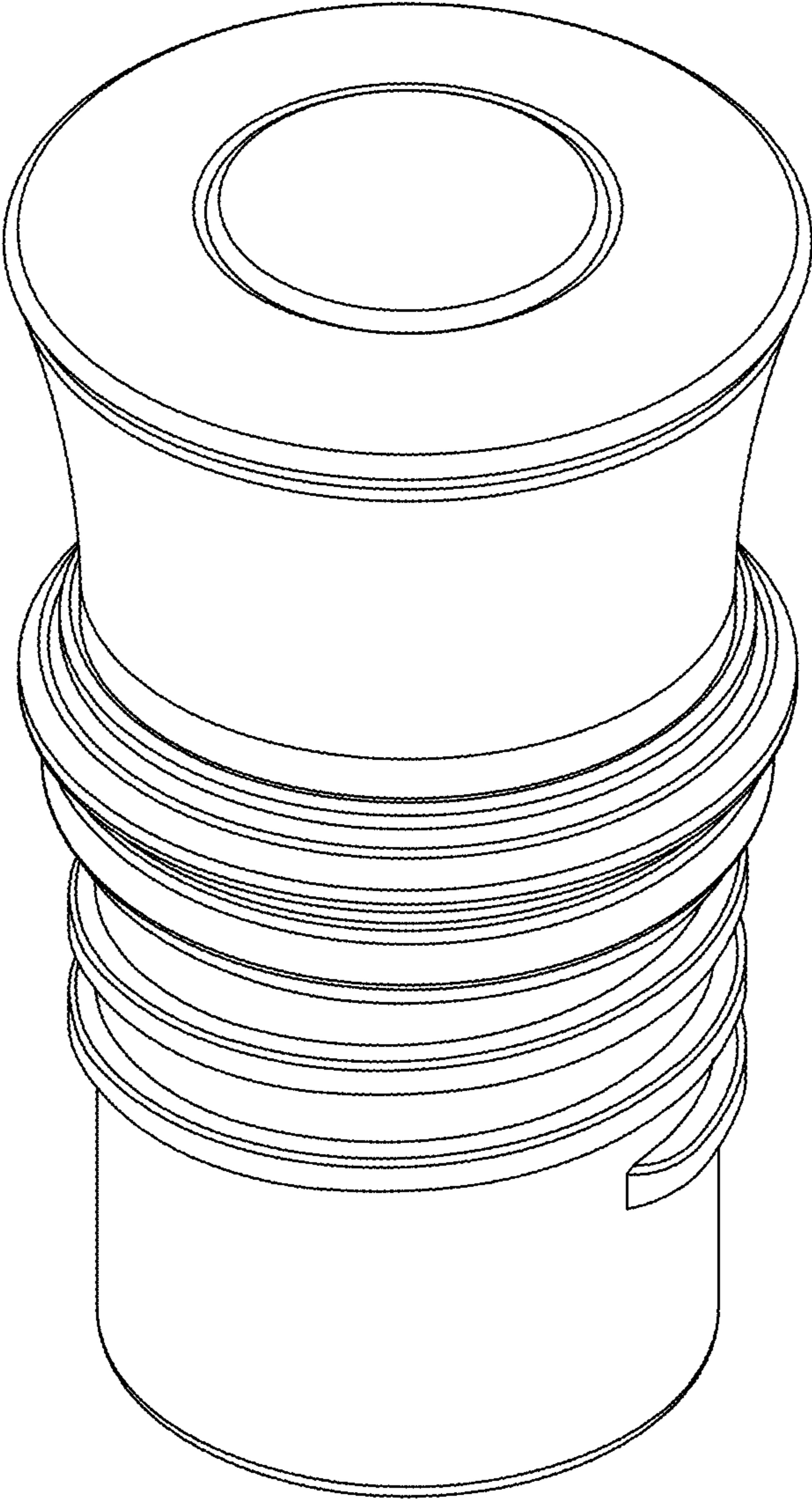
**FIG. 18**



**FIG. 19**



**FIG. 20**



**FIG. 21**