



US00D984170S

(12) **United States Design Patent** (10) **Patent No.:** **US D984,170 S**  
**Choi** (45) **Date of Patent:** **\*\* Apr. 25, 2023**

(54) **PLAYMAT FOR BABY**

FOREIGN PATENT DOCUMENTS

(71) Applicant: **Ggumbi Co., Ltd.**, Suwon-si (KR)

IN 307922-0001 \* 5/2019  
JP D1617162 \* 11/2018

(72) Inventor: **Jinhyi Choi**, Yongin-si (KR)

(Continued)

(73) Assignee: **GGUMBI CO., LTD.**, Suwon-si (KR)

OTHER PUBLICATIONS

(\*\*) Term: **15 Years**

GGumbi clean roll premium, earliest date available unknown, [online], [site visited Dec. 15, 2022]. Available from Internet, <URL: [https://en.ggumbi.com/product/clean-roll-premium-mat-giant-252-double-coating/1886/?cate\\_no=717&display\\_group=1](https://en.ggumbi.com/product/clean-roll-premium-mat-giant-252-double-coating/1886/?cate_no=717&display_group=1)> (Year: 2022).\*

(21) Appl. No.: **29/697,476**

(22) Filed: **Jul. 9, 2019**

(51) **LOC (14) Cl.** ..... **06-13**

(52) **U.S. Cl.**

USPC ..... **D6/596**

(58) **Field of Classification Search**

USPC ..... D6/595, 596, 604, 605, 606  
See application file for complete search history.

(Continued)

*Primary Examiner* — Sanjeev Paul

(74) *Attorney, Agent, or Firm* — Novick, Kim & Lee, PLLC; Byungwoong Park

(56) **References Cited**

(57) **CLAIM**

U.S. PATENT DOCUMENTS

The ornamental design for a playmat for baby, as shown and described.

D246,816 S \* 1/1978 Tam ..... D6/596  
5,066,001 A \* 11/1991 Wilkinson ..... A63B 21/4037  
482/52

D444,550 S \* 7/2001 Cobbs ..... D6/595

D644,865 S \* 9/2011 Trout ..... D6/582

D716,959 S \* 11/2014 Hong ..... D24/212

D807,665 S \* 1/2018 Vega-Woller ..... D6/596

D849,445 S \* 5/2019 Li ..... D6/596

10,342,321 B1 \* 7/2019 Le ..... A47C 17/645

10,655,324 B2 \* 5/2020 Hettier ..... E04C 2/205

D942,178 S \* 2/2022 Chen ..... D6/596

D948,243 S \* 4/2022 Choi ..... D6/596

D948,244 S \* 4/2022 Choi ..... D6/596

2004/0191483 A1 \* 9/2004 Cartier ..... E04F 15/00  
428/167

2005/0039260 A1 \* 2/2005 Tyler ..... A47G 9/062  
2/84

2008/0118671 A1 \* 5/2008 Bienkiewicz ..... A63B 21/4037  
428/12

(Continued)

**DESCRIPTION**

FIG. 1 is a perspective view of a playmat for baby showing my new design;  
FIG. 2 is a front elevational view thereof;  
FIG. 3 is a rear elevational view thereof;  
FIG. 4 is a left side elevational view thereof;  
FIG. 5 is a right side elevational view thereof;  
FIG. 6 is a top plan view thereof;  
FIG. 7 is a bottom plan view thereof;  
FIG. 8 is another perspective view thereof showing an alternative configuration; and,  
FIG. 9 is another perspective view thereof showing a second alternative configuration.

**1 Claim, 9 Drawing Sheets**

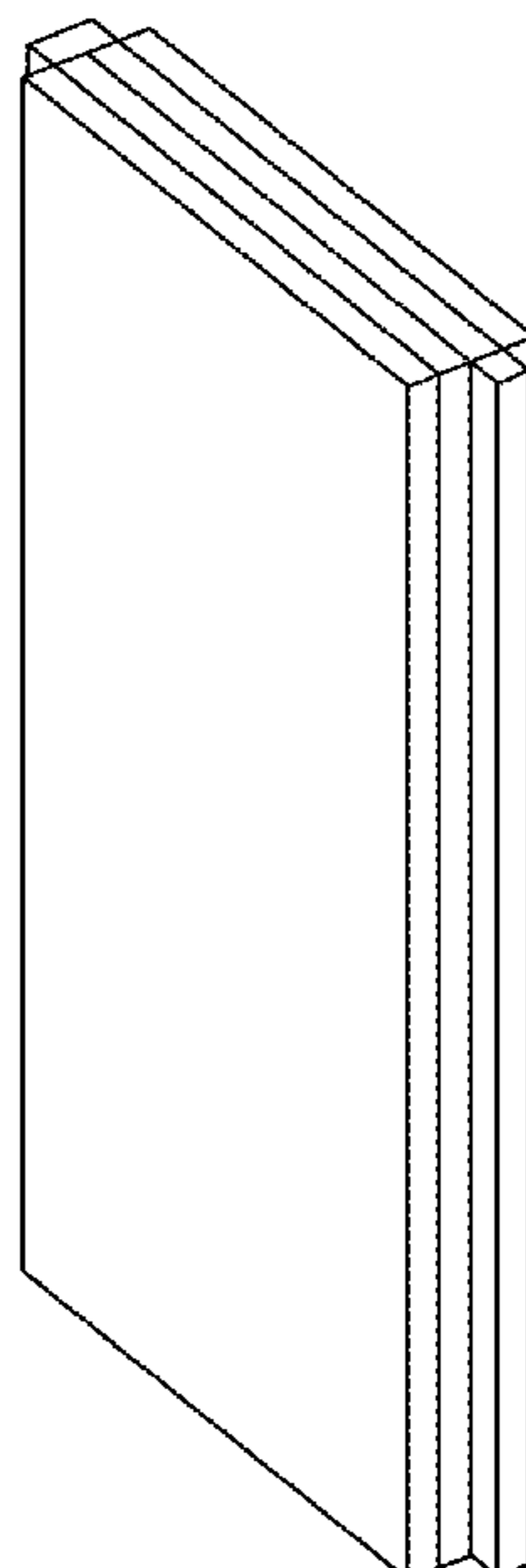

(56)

References Cited

U.S. PATENT DOCUMENTS

2010/0227124 A1\* 9/2010 Sharir ..... A47G 27/0212  
428/317.1  
2014/0101848 A1\* 4/2014 Murphy ..... A47G 9/08  
5/420  
2015/0113731 A1\* 4/2015 Liu ..... A63B 6/00  
5/417  
2015/0251046 A1\* 9/2015 Liu ..... A47G 9/06  
5/420  
2015/0305525 A1\* 10/2015 Clearman ..... A47G 9/062  
5/482  
2016/0000231 A1\* 1/2016 Auell ..... A47C 27/15  
5/420  
2017/0095690 A1\* 4/2017 Sharkey ..... A47G 27/0237  
2021/0244991 A1\* 8/2021 Pickett ..... H01F 7/0252  
2021/0275857 A1\* 9/2021 Christ ..... A63B 21/4037

FOREIGN PATENT DOCUMENTS

KR 300856534.0000 \* 6/2016  
KR 300957552.0000 \* 5/2018  
KR 300957553.0000 \* 5/2018  
KR 301055655.0000 \* 4/2020  
KR 301055657.0000 \* 4/2020  
KR 301095573.0000 \* 2/2021  
KR 301095575.0000 \* 2/2021

KR 301096723.0000 \* 2/2021  
KR 301096724.0000 \* 2/2021  
KR 301096725.0000 \* 2/2021  
KR 301096726.0000 \* 2/2021  
KR 301096727.0000 \* 2/2021  
KR 301096728.0000 \* 2/2021  
KR 301096729.0000 \* 2/2021  
KR 301098312.0000 \* 3/2021  
KR 301149890.0000 \* 2/2022

OTHER PUBLICATIONS

Google Term Search: 'playmat', [site visited Dec. 15, 2022]  
<URL:https://www.google.com/search?q=playmat&sxsrf=ALiCzsY  
mcYPiWgg23uz5fuYfJMS5nEU43Q:1671118080187&source=lnms  
&tbm=isch&sa=X&ved=2ahUKEwjG-6\_89\_  
v7AhXBGfKfHYqqBkAQ\_AUoAnoECAEQBA&biw=1200&bih=  
1777&dpr=1> (Year: 2022).\*

Uanlao Foldable Baby Play Mat, earliest pictured review:Dec. 25,  
2018, [online], [site visited Dec. 15, 2022]. Available from Internet,  
<URL: https://www.amazon.com/UANLAUO-Foldable-Waterproof-  
Activity-Playmats/dp/B09NBBJW17/ref=sr\_1\_3?crid=  
34IQXGDRMCI76&keywords=UANLAUO%2BFoldable%2BBaby%  
2BPlay&qid=1671149079&srefix=uanlao%2Bfoldable%2Bbaby%  
2Bplay%2Caps%2C402&sr=8-3&th=1> (Year: 2018).\*

\* cited by examiner

FIG. 1

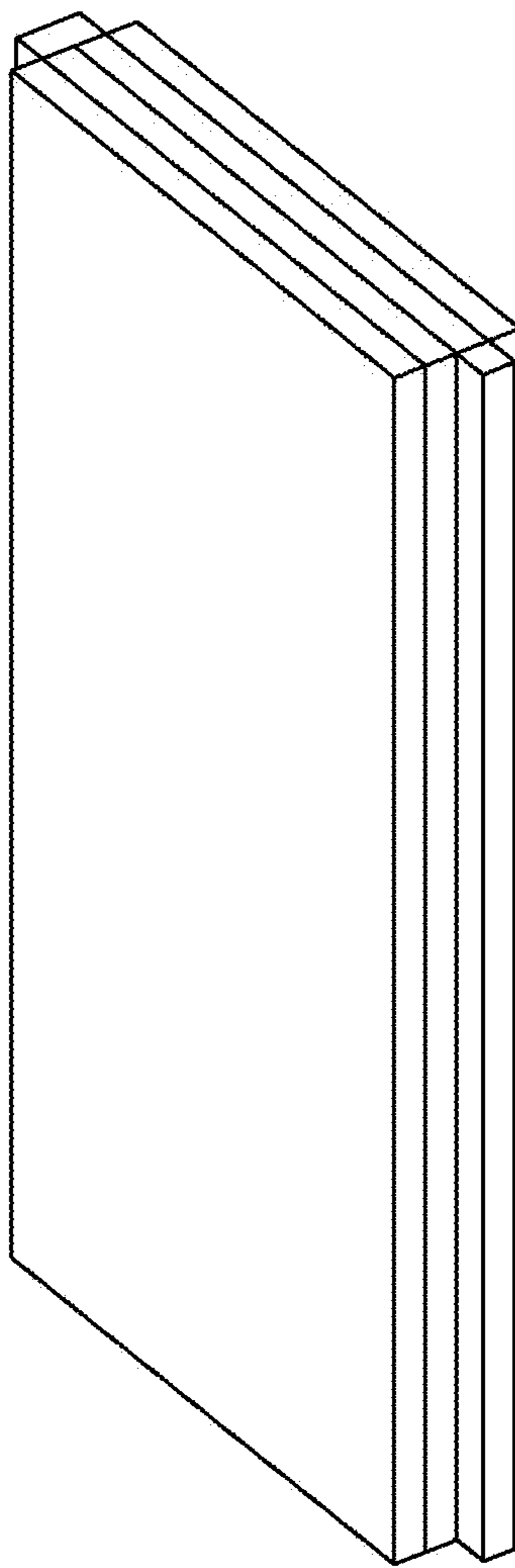

FIG. 2

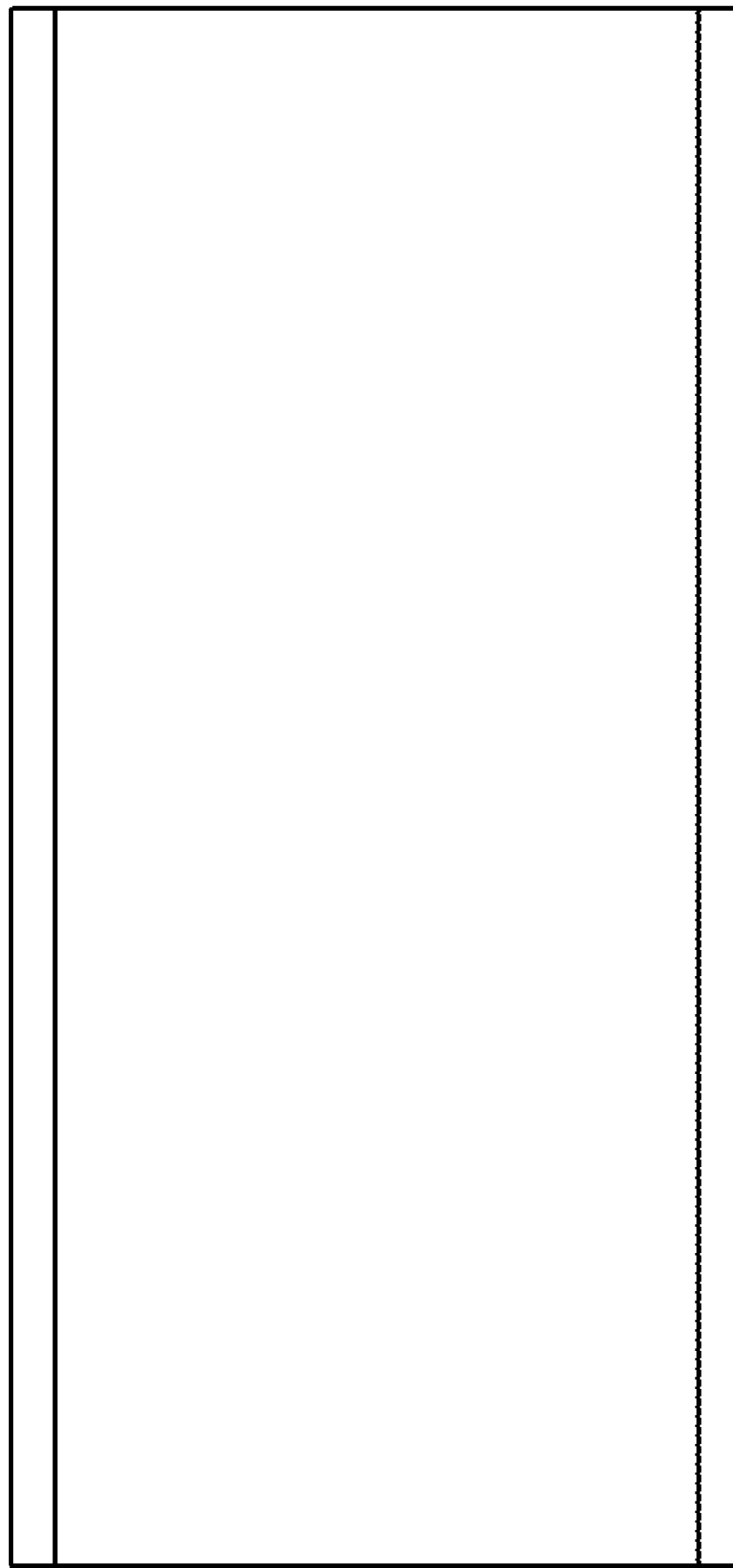

FIG. 3

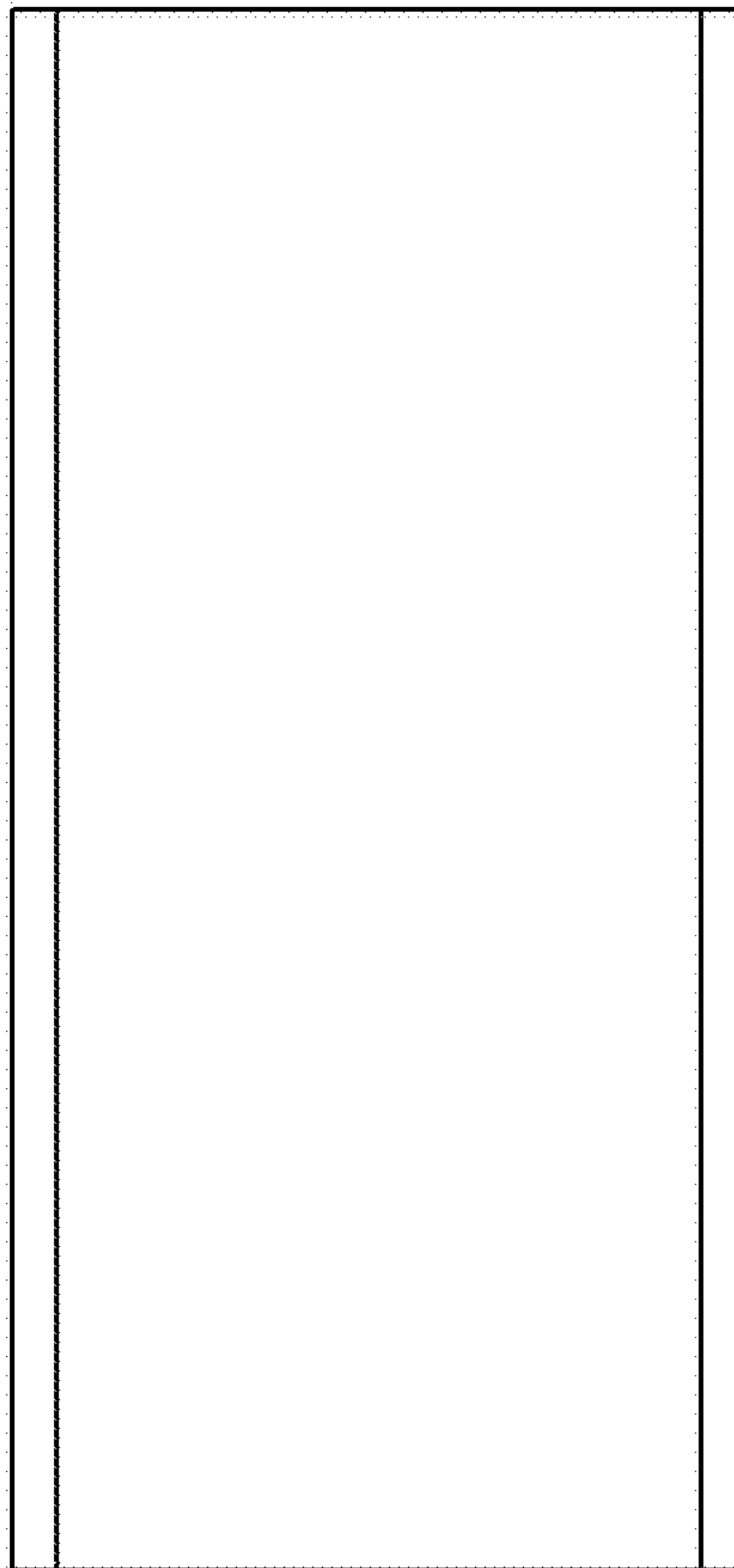

FIG. 4

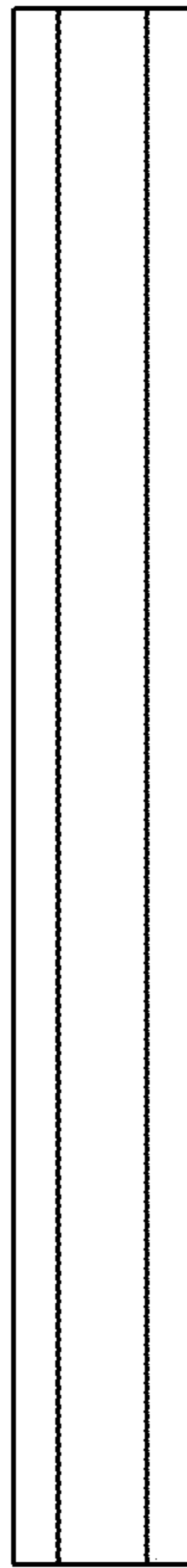

FIG. 5

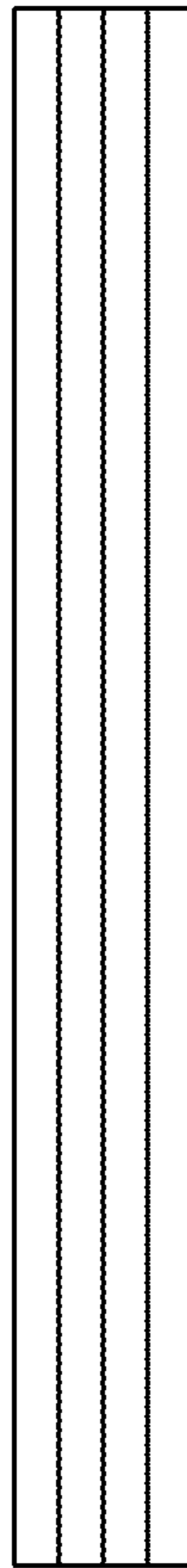

FIG. 6

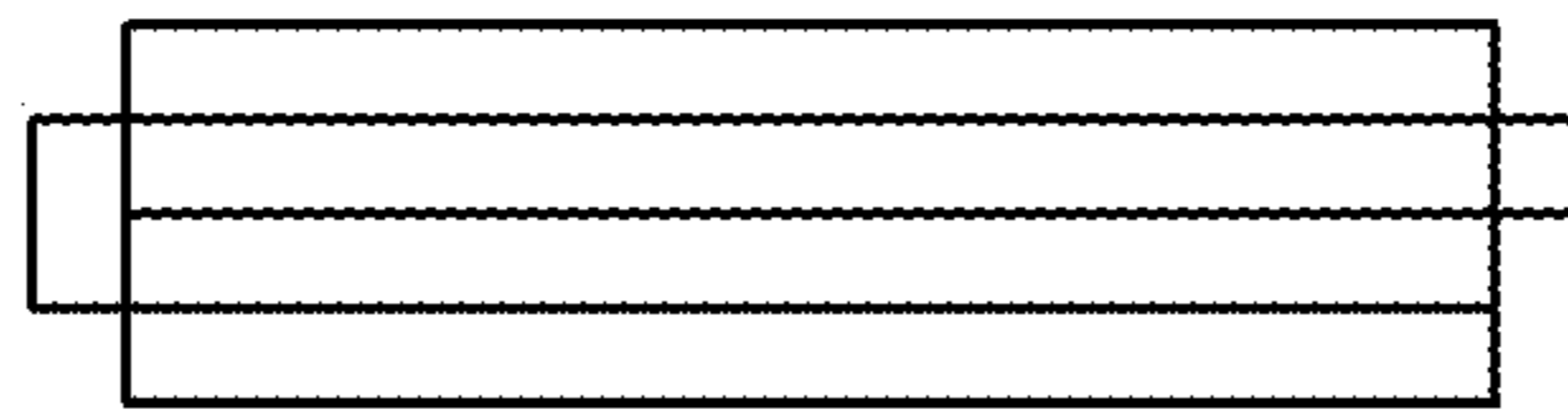



FIG. 7



FIG. 8

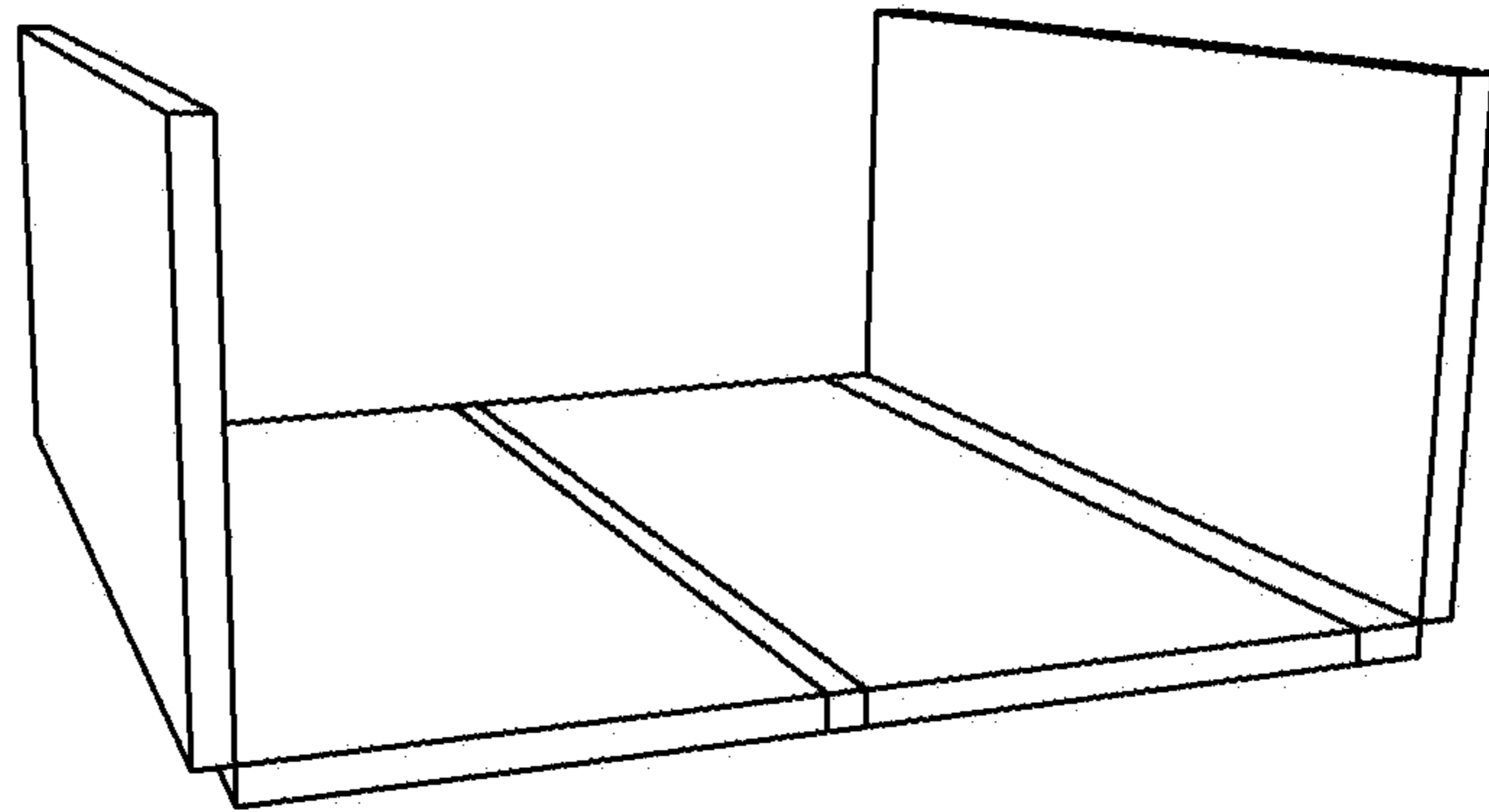

FIG. 9

