



US00D984166S

(12) **United States Design Patent** (10) **Patent No.:** **US D984,166 S**  
**Kuang** (45) **Date of Patent:** **\*\* Apr. 25, 2023**

(54) **DISPLAY RACK WITH HANGING HOOKS**

(71) Applicant: **Xiaolu Kuang**, Hubei (CN)

(72) Inventor: **Xiaolu Kuang**, Hubei (CN)

(\*\*) Term: **15 Years**

(21) Appl. No.: **29/852,896**

(22) Filed: **Sep. 9, 2022**

(51) **LOC (14) Cl.** ..... **06-04**

(52) **U.S. Cl.**  
USPC ..... **D6/552**

(58) **Field of Classification Search**  
USPC ..... D6/567, 671, 672, 673, 675, 675.1, 705,  
D6/512, 524, 552, 553, 572, 573, 574,  
D6/569; D11/132, 131, 140; D20/10,  
D20/19, 42; D3/903, 904; D19/9, 20;  
D7/354; D8/345, 363, 367, 371-373, 380  
CPC ..... A47F 3/00; A47F 5/00; A47F 5/11; A47F  
7/00; B65D 5/52; G09F 5/00; G09F 5/02;  
A47G 1/0616; A47G 1/00; A47G  
2001/005; A47G 1/06; A47G 1/0605;  
A47G 2001/0677; A63F 13/00; A47J  
37/00; A47J 36/00; A47J 37/01  
See application file for complete search history.

(56) **References Cited**

**U.S. PATENT DOCUMENTS**

D171,222 S \* 12/1953 Odium ..... D6/574  
D310,762 S \* 9/1990 Embree ..... D6/569  
4,984,693 A \* 1/1991 Belokin, Jr. .... A47F 5/0876  
D6/567  
D327,197 S \* 6/1992 Belokin, Jr. .... D6/567  
D394,775 S \* 6/1998 Anderson ..... D6/574

D404,952 S \* 2/1999 Bauer ..... D6/552  
D705,577 S \* 5/2014 Goodman ..... D6/572  
D743,779 S \* 11/2015 Cohen ..... D8/371  
D786,580 S \* 5/2017 Chesterton ..... D6/552  
D844,418 S 4/2019 Kacines  
D860,677 S \* 9/2019 Chesterton ..... D6/552  
D871,503 S 12/2019 Andrzejewski  
D878,095 S \* 3/2020 Dunahay ..... D6/553  
D916,513 S \* 4/2021 Kuang ..... D6/567  
D953,065 S \* 5/2022 Wang ..... D6/567

**OTHER PUBLICATIONS**

Walmart website, huoge Medal Hanger Medal Display Hanger Black Iron Sports Medal Storage Holder, Dec. 21, 2022, <https://www.walmart.com/ip/huoge-Medal-Hanger-Medal-Display-Hanger-Black-Iron-Sports-Medal-Storage-Holder-Wall-Mount-Medals-Rack-for-Variou-Medals/1250839628> (Year: 2022).\*

\* cited by examiner

*Primary Examiner* — Nathan M Johnston

(57) **CLAIM**

The ornamental design for a display rack with hanging hooks, as shown and described.

**DESCRIPTION**

FIG. 1 is a front, left and top side perspective view of a display rack with hanging hooks showing my new design; FIG. 2 is a front elevational view thereof; FIG. 3 is a back devotional view thereof; FIG. 4 is a bottom plan view thereof; FIG. 5 is a top plan view thereof; FIG. 6 is a left side elevational view thereof; and, FIG. 7 is a right side elevational view thereof.

**1 Claim, 7 Drawing Sheets**

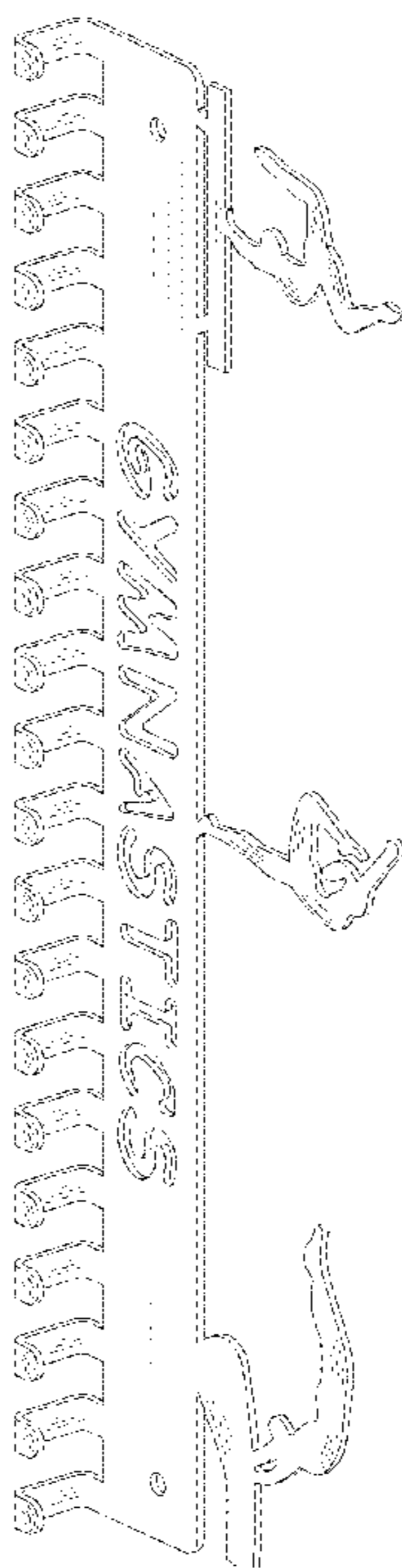

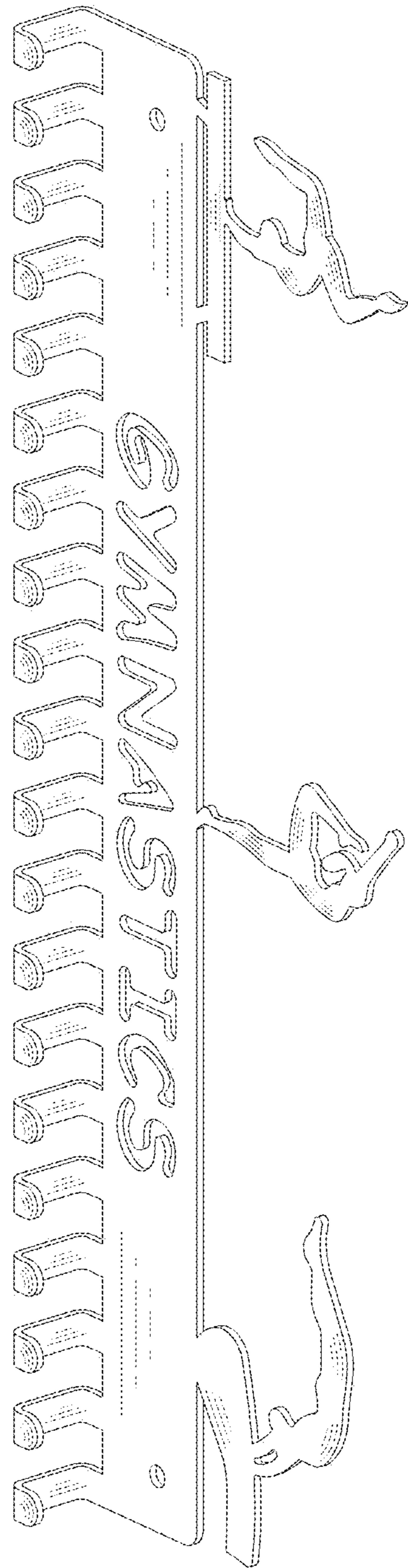

FIG. 1

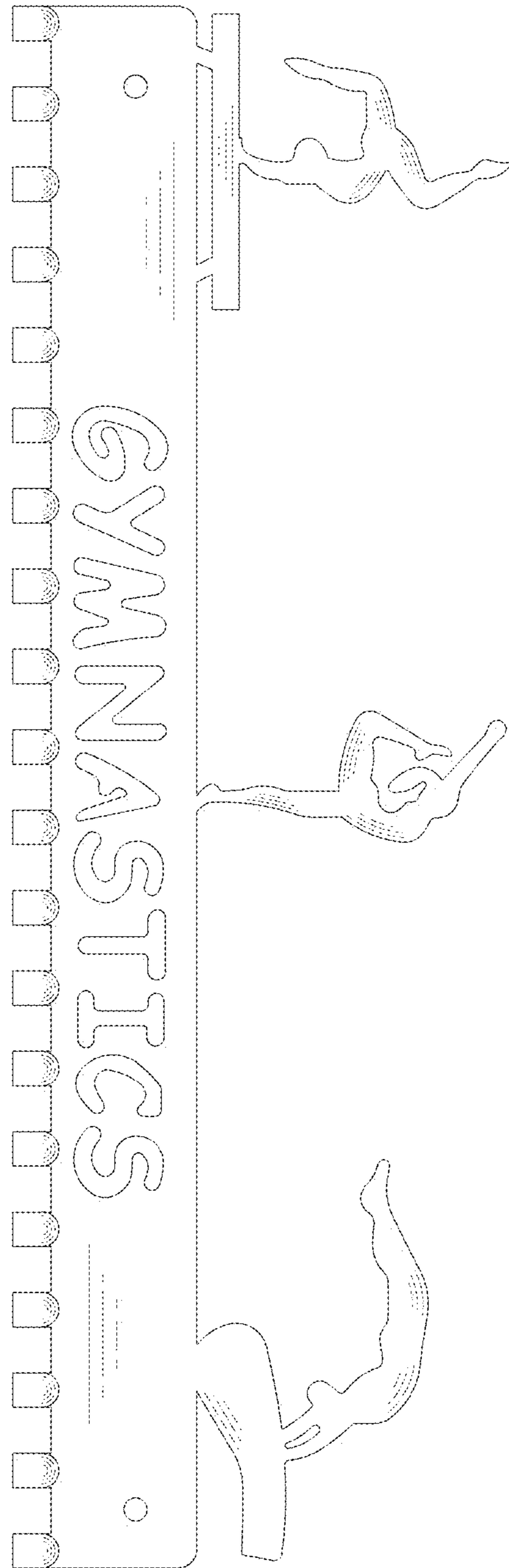

FIG. 2

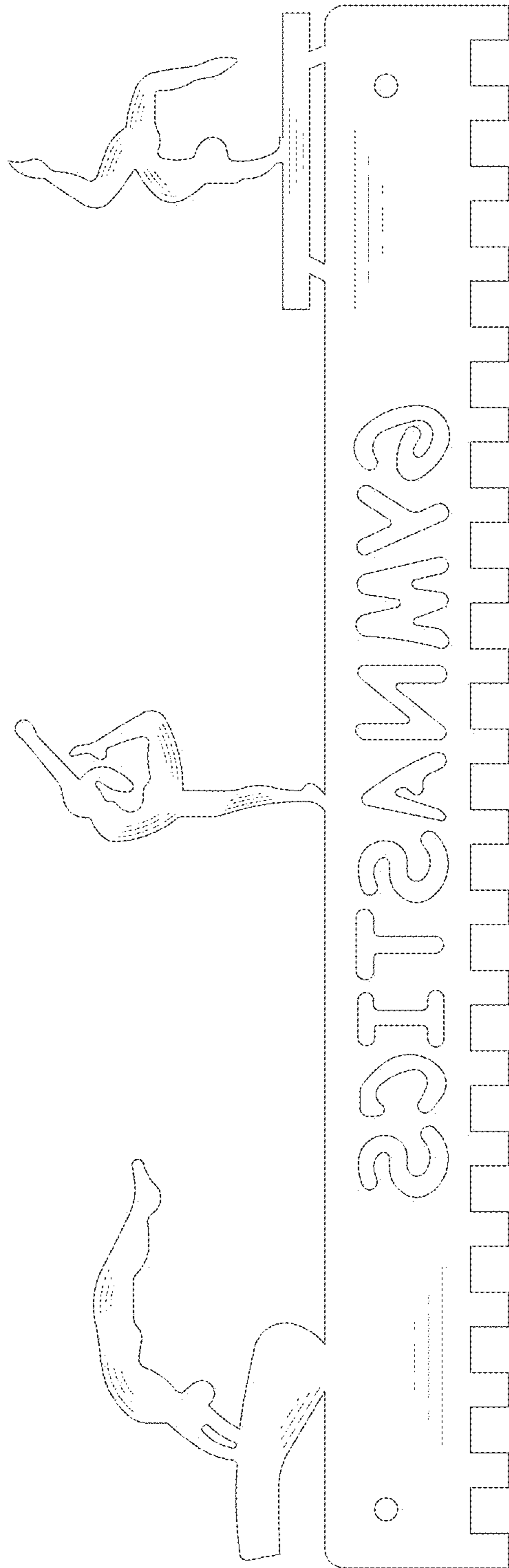

FIG. 3

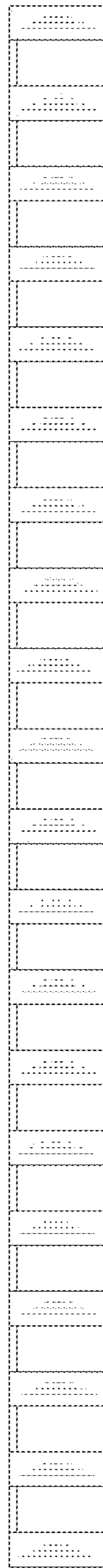

FIG. 4

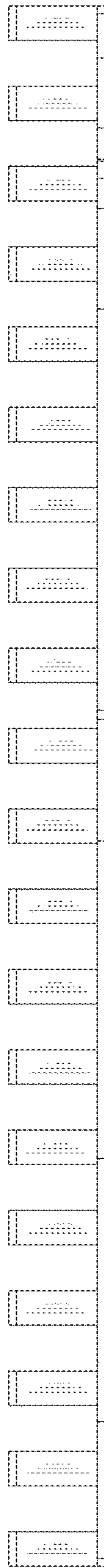

FIG. 5

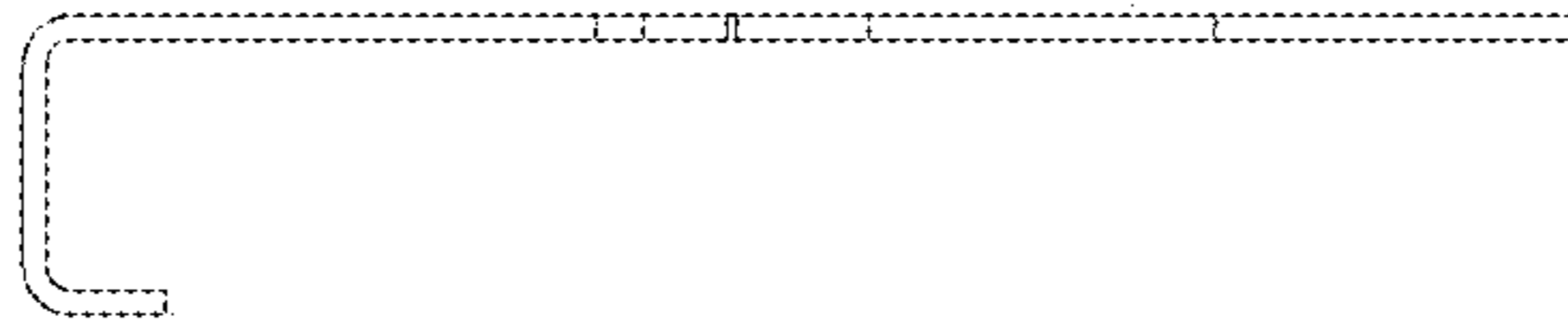

FIG. 6

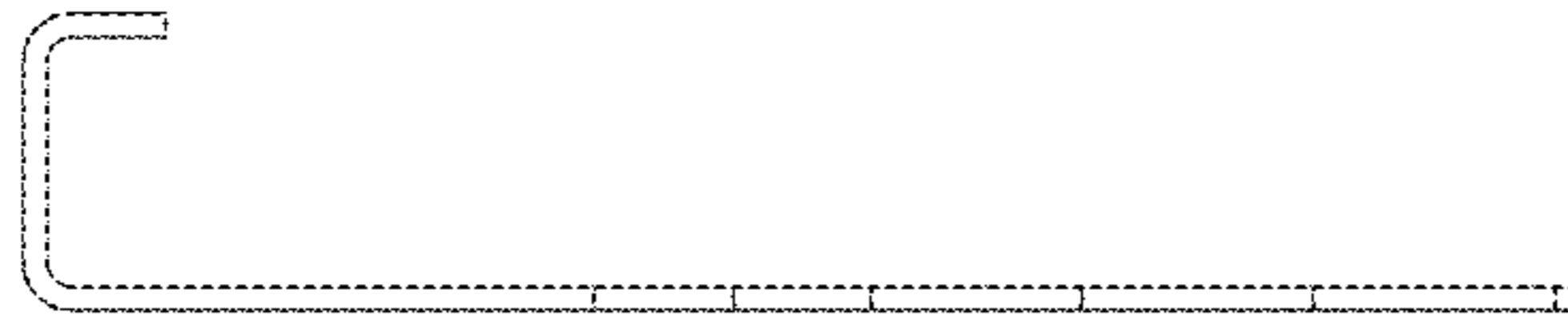

FIG. 7