



US00D984006S

(12) **United States Design Patent**
Yu

(10) **Patent No.:** **US D984,006 S**
(45) **Date of Patent:** **** Apr. 18, 2023**

(54) **GROUND LIGHT**

(71) Applicant: **Yingliang Yu**, Ma'anshan (CN)

(72) Inventor: **Yingliang Yu**, Ma'anshan (CN)

(*) Notice: Patent file contains an affidavit/declaration under 37 CFR 1.130(b).

(**) Term: **15 Years**

(21) Appl. No.: **29/837,174**

(22) Filed: **May 3, 2022**

(51) **LOC (14) Cl.** **26-02**

(52) **U.S. Cl.**
USPC **D26/37; D26/2**

(58) **Field of Classification Search**
USPC D26/1, 2, 5, 7, 67-70, 72, 78, 85
CPC F21S 9/037; F21W 2111/02
See application file for complete search history.

(56) **References Cited**

U.S. PATENT DOCUMENTS

- 6,056,422 A * 5/2000 Huang F21S 4/10
362/396
- 6,409,364 B1 * 6/2002 Lin F21V 21/088
362/396
- D499,831 S 12/2004 Chen
- D500,381 S 12/2004 Chen
- D502,781 S 3/2005 Chen
- 7,178,970 B2 * 2/2007 Chiu F21V 19/006
439/699.2
- D563,586 S 3/2008 Lee
- D615,683 S 5/2010 Chen
- D615,686 S 5/2010 Chen
- D615,687 S 5/2010 Chen
- D616,135 S 5/2010 Chen
- D629,133 S 12/2010 Chen
- D694,931 S 12/2013 Meyer
- D734,511 S * 7/2015 Liu D26/2
- D739,567 S * 9/2015 Howard D26/2
- D740,971 S * 10/2015 Howard D26/2

- D791,372 S * 7/2017 Rouse D26/4
- D814,070 S * 3/2018 Wu D26/2
- D823,495 S * 7/2018 Liao D26/2
- D831,241 S * 10/2018 Wei D26/4
- D841,839 S * 2/2019 Ma D26/2
- D866,387 S * 11/2019 Pan D26/2
- D961,832 S * 8/2022 Xiao D26/67

(Continued)

OTHER PUBLICATIONS

Amazon—(<https://a.co/d/d7B3gVN>), Christmas Lights Jumbo C9 Outdoor Lawn Decorations with Pathway Marker Stakes, 2 Pack 8.5 Feet String Lights Covered Jumbo Multicolored Light Bulb for Holiday Outside Yard Garden Decor, 10 Lights, Sep. 9, 2021 (Year: 2021).*

(Continued)

Primary Examiner — Keli L Hill
Assistant Examiner — Harold E Blackwell, II
(74) *Attorney, Agent, or Firm* — Rumit Ranjit Kanakia

(57) **CLAIM**

The ornamental design for a ground light, as shown and described.

DESCRIPTION

FIG. 1 is a perspective view of a ground light showing my new design;
FIG. 2 is another perspective view thereof;
FIG. 3 is a front elevational view thereof;
FIG. 4 is a rear elevational view thereof;
FIG. 5 is a left side elevational view thereof;
FIG. 6 is a right side elevational view thereof;
FIG. 7 is a top plan view thereof; and,
FIG. 8 is a bottom plan view thereof.
The broken lines in the figures are for the purpose of illustrating portions of the ground light, that form no part of the claimed design.

1 Claim, 5 Drawing Sheets

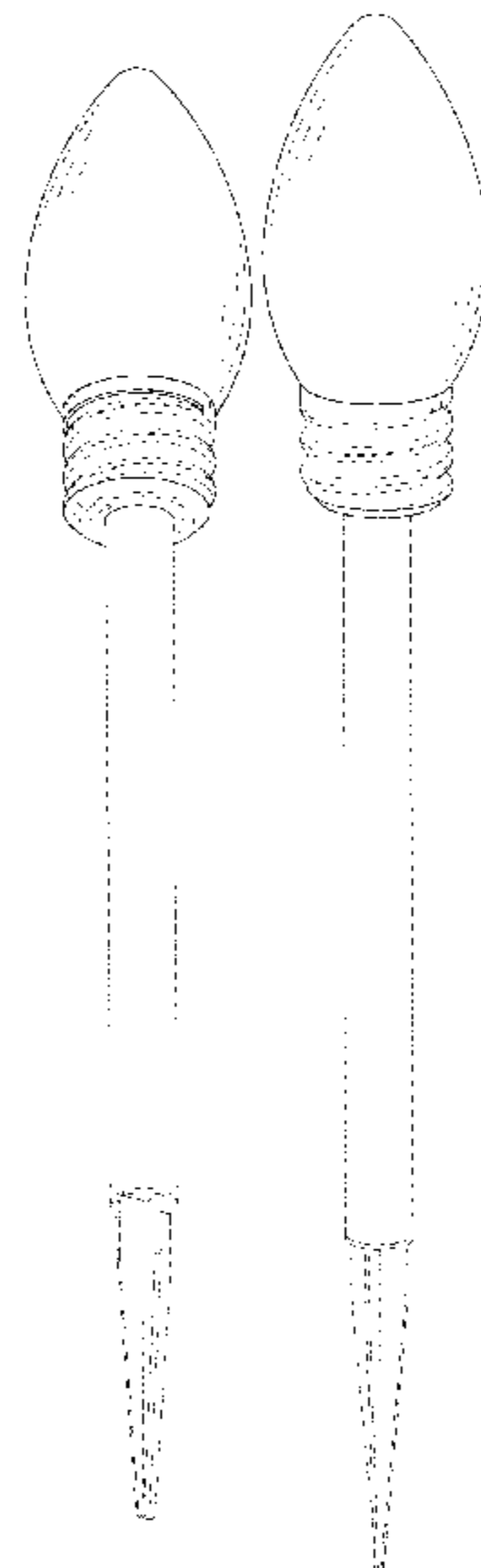

(56)

References Cited

U.S. PATENT DOCUMENTS

2002/0000504 A1* 1/2002 Bayne F21S 4/10
248/302
2009/0185370 A1* 7/2009 Moore F21S 4/10
362/219
2018/0048085 A1* 2/2018 Fuda H01R 25/003

OTHER PUBLICATIONS

Christmas Lights Jumbo Outdoor Lawn Decorations with Pathway Marker Stakes, String Lights Covered Jumbo Multicolored Light Bulb for Holiday Outside Yard Garden Decor, amazon.com, May 25, 2022, Bossern, https://www.amazon.com/dp/B095SMWBT1?ref=myi_title_dp, (Last accessed : Dec. 6, 2022).

* cited by examiner

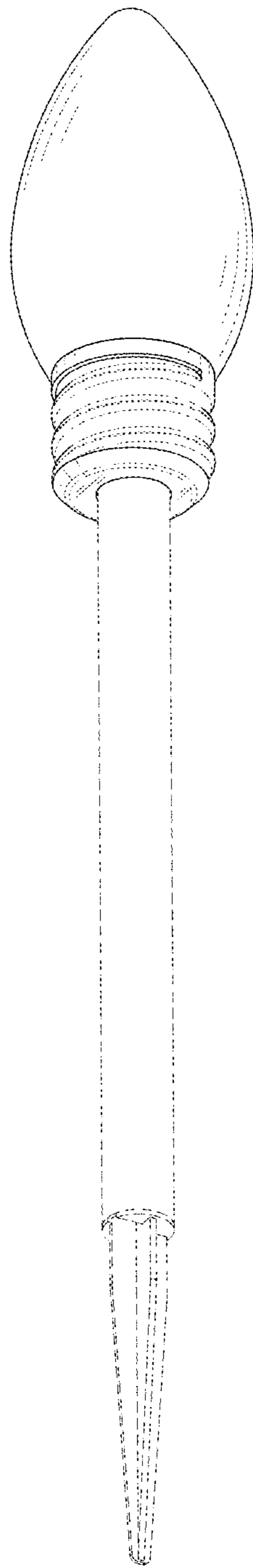

FIG. 1

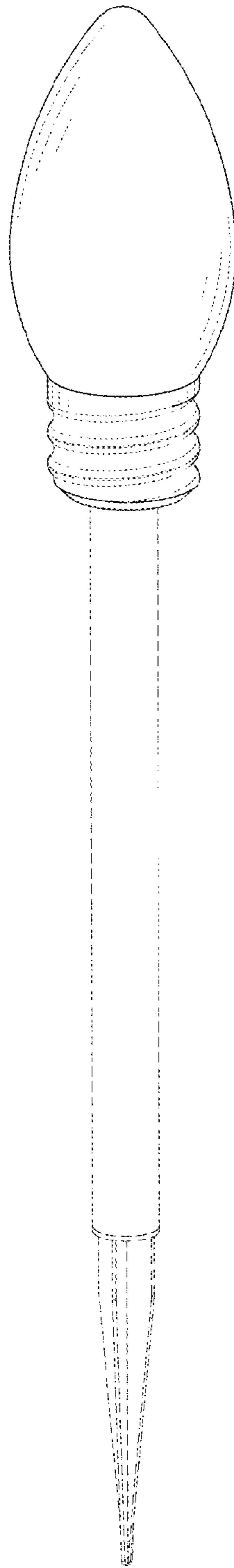

FIG. 2

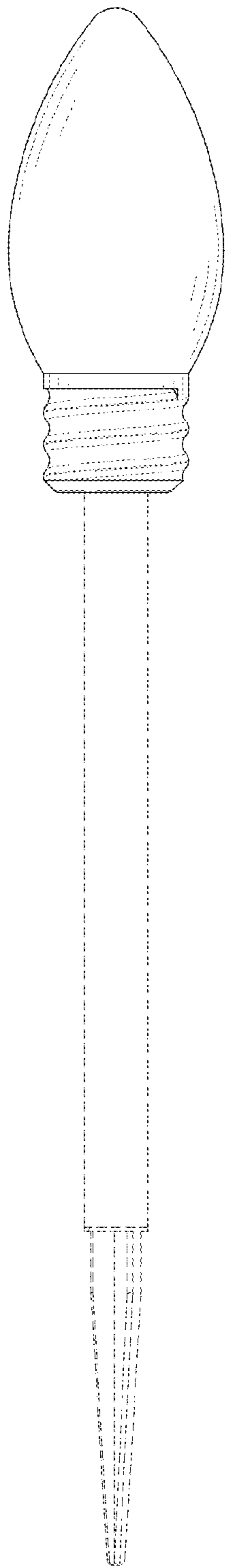

FIG. 3

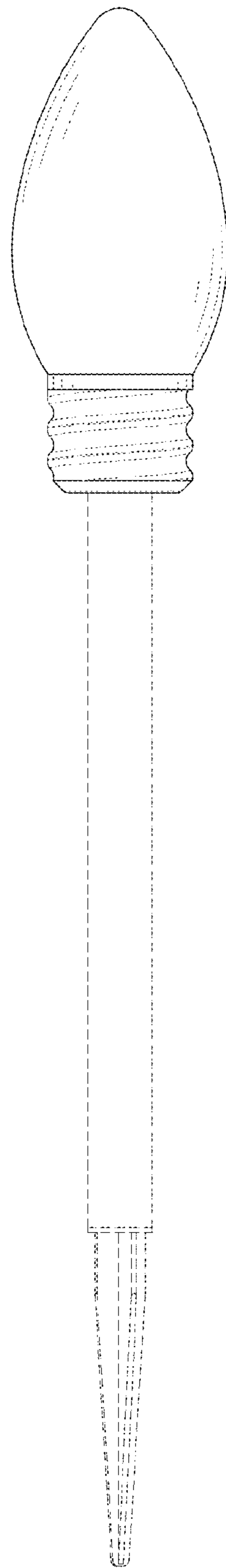

FIG. 4

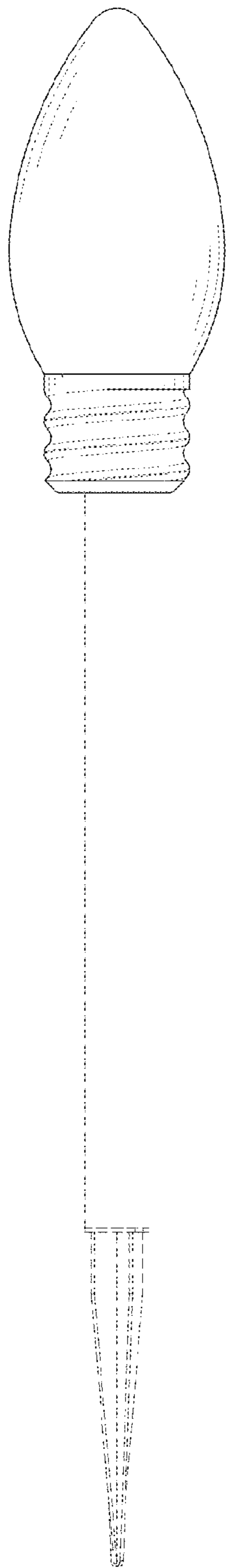

FIG. 5

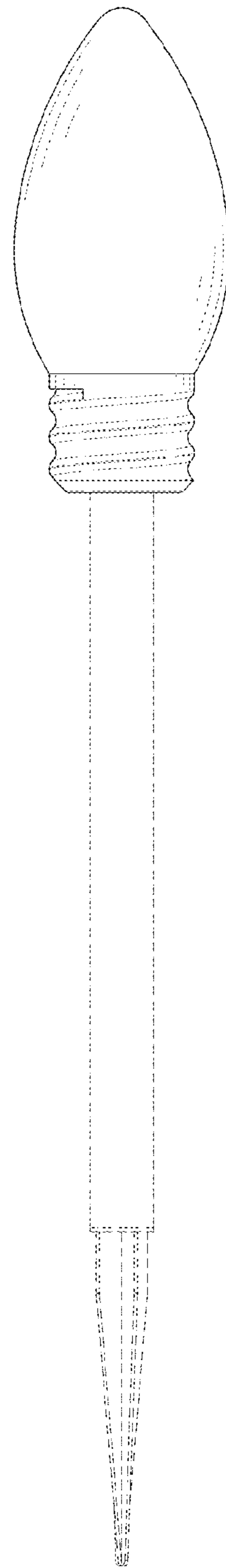

FIG. 6

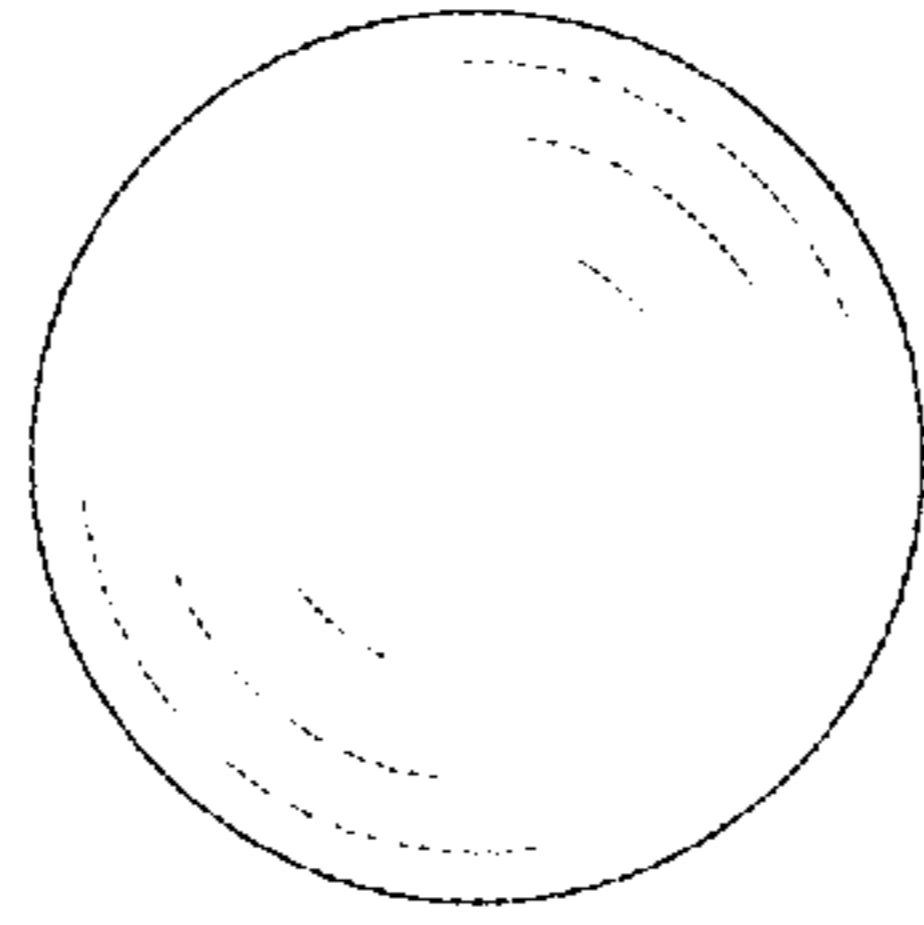

FIG. 7

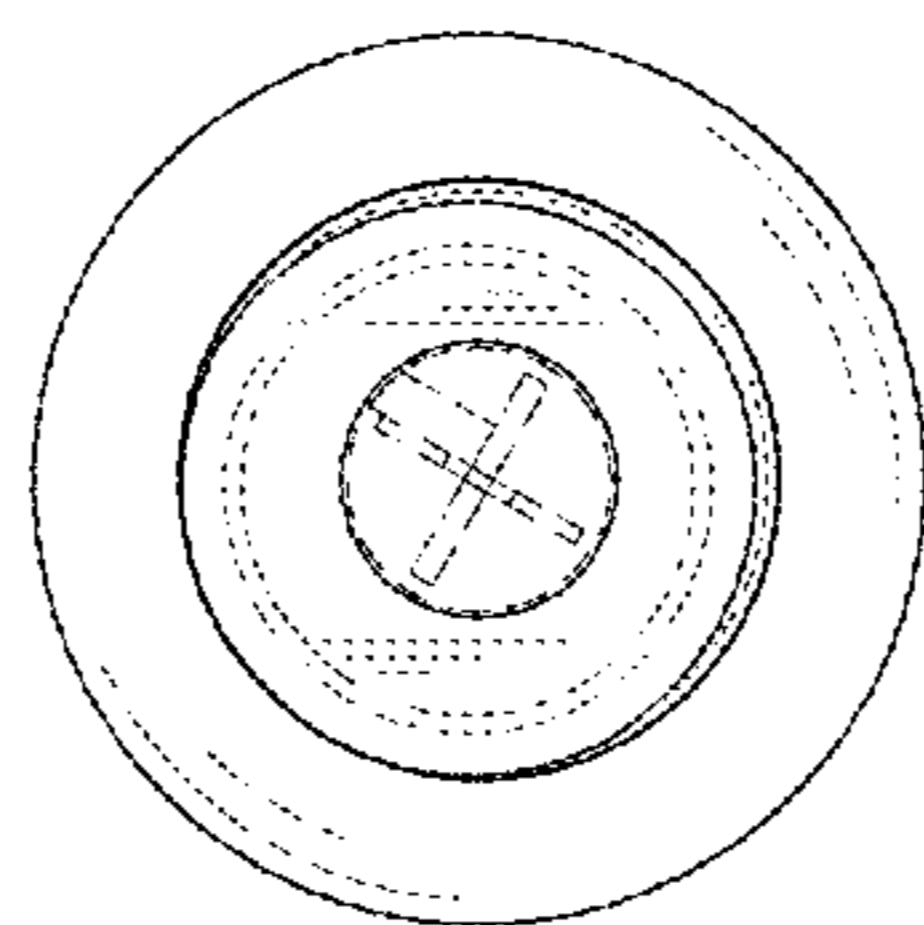

FIG. 8