



US00D984005S

(12) **United States Design Patent** (10) **Patent No.:** **US D984,005 S**
Akcaay (45) **Date of Patent:** **** Apr. 18, 2023**

(54) **VEHICLE TAILLIGHT**
(71) Applicant: **VOLKSWAGEN AKTIENGESELLSCHAFT, Wolfsburg (DE)**
(72) Inventor: **Cihan Akcaay, Wolfsburg (DE)**
(73) Assignee: **VOLKSWAGEN AKTIENGESELLSCHAFT, Wolfsburg (DE)**
(**) Term: **15 Years**
(21) Appl. No.: **29/811,299**
(22) Filed: **Oct. 13, 2021**
(51) **LOC (14) Cl.** **26-06**
(52) **U.S. Cl.**
USPC **D26/28**
(58) **Field of Classification Search**
USPC D26/28, 29, 30, 31, 32, 33, 34, 35, 36, D26/139
CPC F21S 41/00; F21S 41/141; F21S 41/162; F21S 41/18; F21S 41/20; F21S 41/33; F21S 41/36; F21S 41/60; F21S 43/00; F21W 2103/35; F21W 2103/40; F21W 2102/17; F21W 2102/30; F21W 2103/00; F21W 2103/55; F21W 2104/00; F21W 2107/17; F21W 2107/13
See application file for complete search history.

(56) **References Cited**
U.S. PATENT DOCUMENTS
D695,935 S * 12/2013 Ueda D26/28
D714,475 S * 9/2014 Osborne D26/28
D775,378 S * 12/2016 Hatton D26/28
D834,223 S * 11/2018 Werner D26/28
D871,623 S * 12/2019 Tovey D26/28
D871,627 S * 12/2019 Hirata D26/28
D897,011 S * 9/2020 Momokawa D26/28

D903,910 S * 12/2020 Kato D26/28
D905,881 S * 12/2020 Katou D26/28
D920,552 S * 5/2021 Runde D26/28
(Continued)

FOREIGN PATENT DOCUMENTS

WO DM206354 2/2020
Primary Examiner — Angela J Lee
(74) *Attorney, Agent, or Firm* — Lucas & Mercanti, LLP; Klaus P. Stoffel

(57) **CLAIM**
The ornamental design for a vehicle taillight, as shown and described.

DESCRIPTION

FIG. 1 is a front and top perspective view of a first embodiment of the vehicle taillight showing the present design;
FIG. 2 is a right side view thereof;
FIG. 3 is a left side view thereof;
FIG. 4 is a front view thereof;
FIG. 5 is a top view thereof;
FIG. 6 is a bottom view thereof;
FIG. 7 is a left side perspective view thereof;
FIG. 8 is a rear view thereof;
FIG. 9 is a front and top perspective view of a second embodiment of the vehicle taillight showing the present design, the second embodiment being a mirror image of the first embodiment;
FIG. 10 is a right side view thereof;
FIG. 11 is a left side view thereof;
FIG. 12 is a front view thereof;
FIG. 13 is a top view thereof;
FIG. 14 is a bottom view thereof;
FIG. 15 is a right side perspective view thereof; and,
FIG. 16 is a rear view thereof.
The text "IQ.LIGHT" forming part of the claimed design is a registered trademark of Volkswagen Aktiengesellschaft.

1 Claim, 10 Drawing Sheets

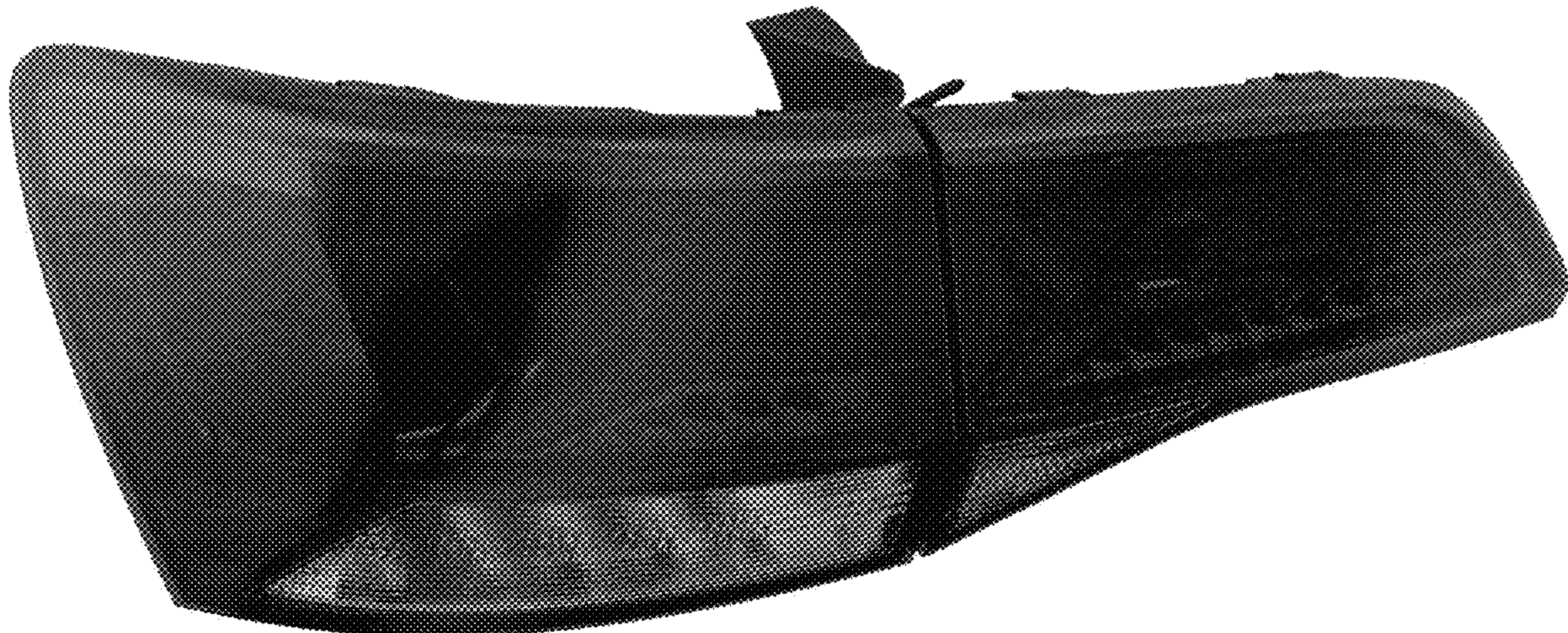

(56)

References Cited

U.S. PATENT DOCUMENTS

D925,790 S * 7/2021 Jobling D26/28
D972,177 S * 12/2022 Yang D26/28
D973,243 S * 12/2022 Mizutani D26/28

* cited by examiner



Fig. 1

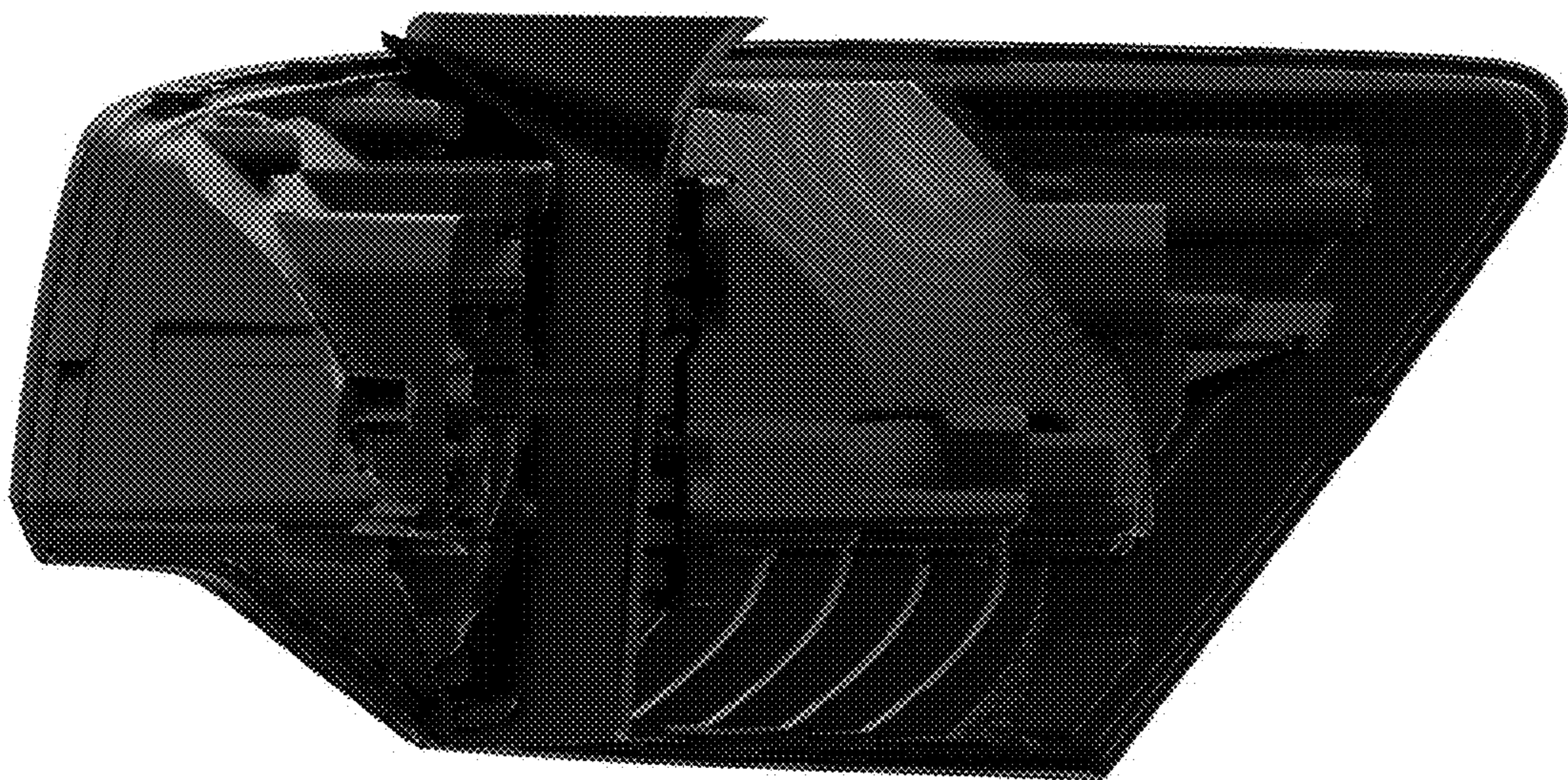

Fig. 2

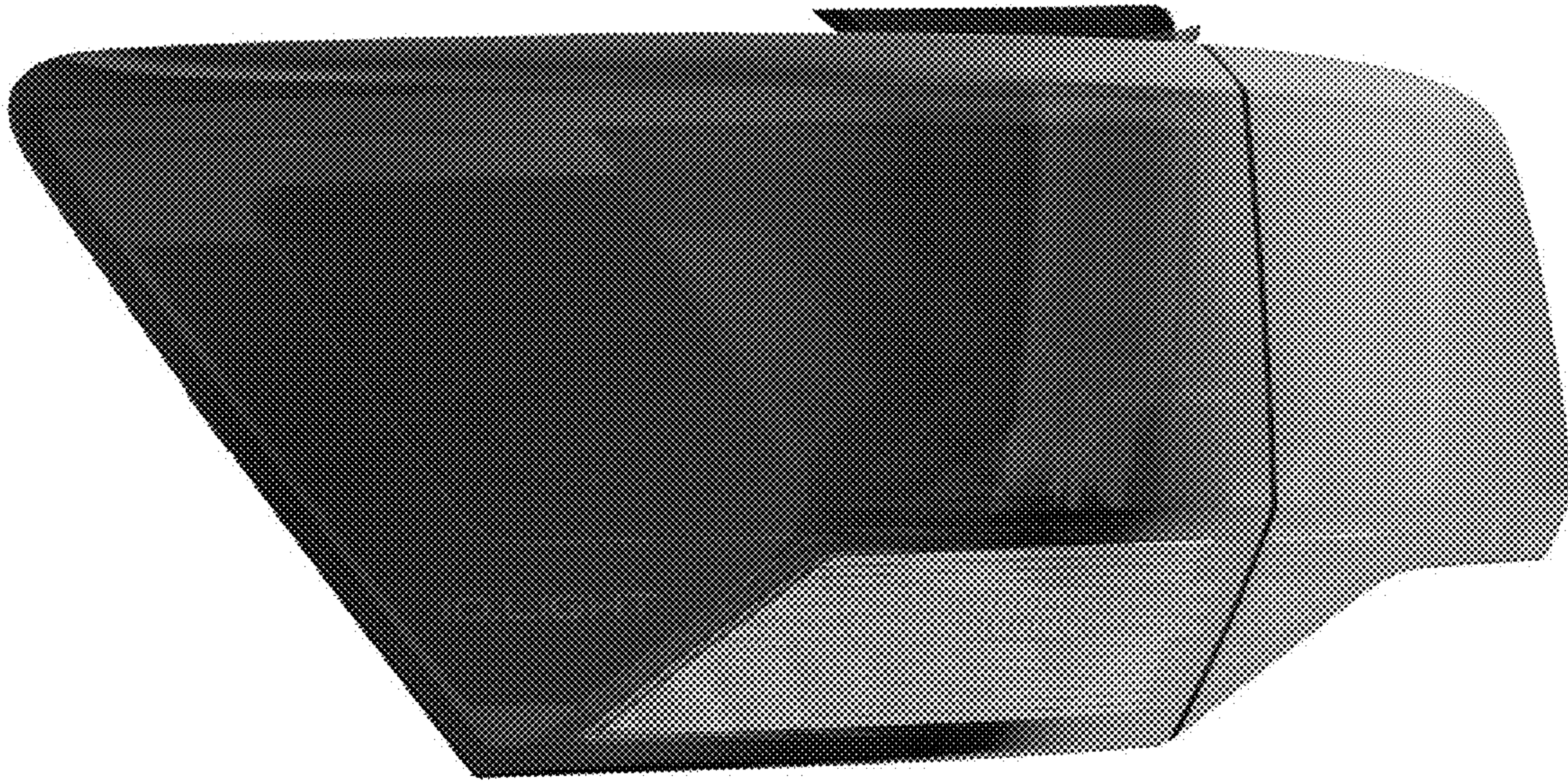

Fig. 3

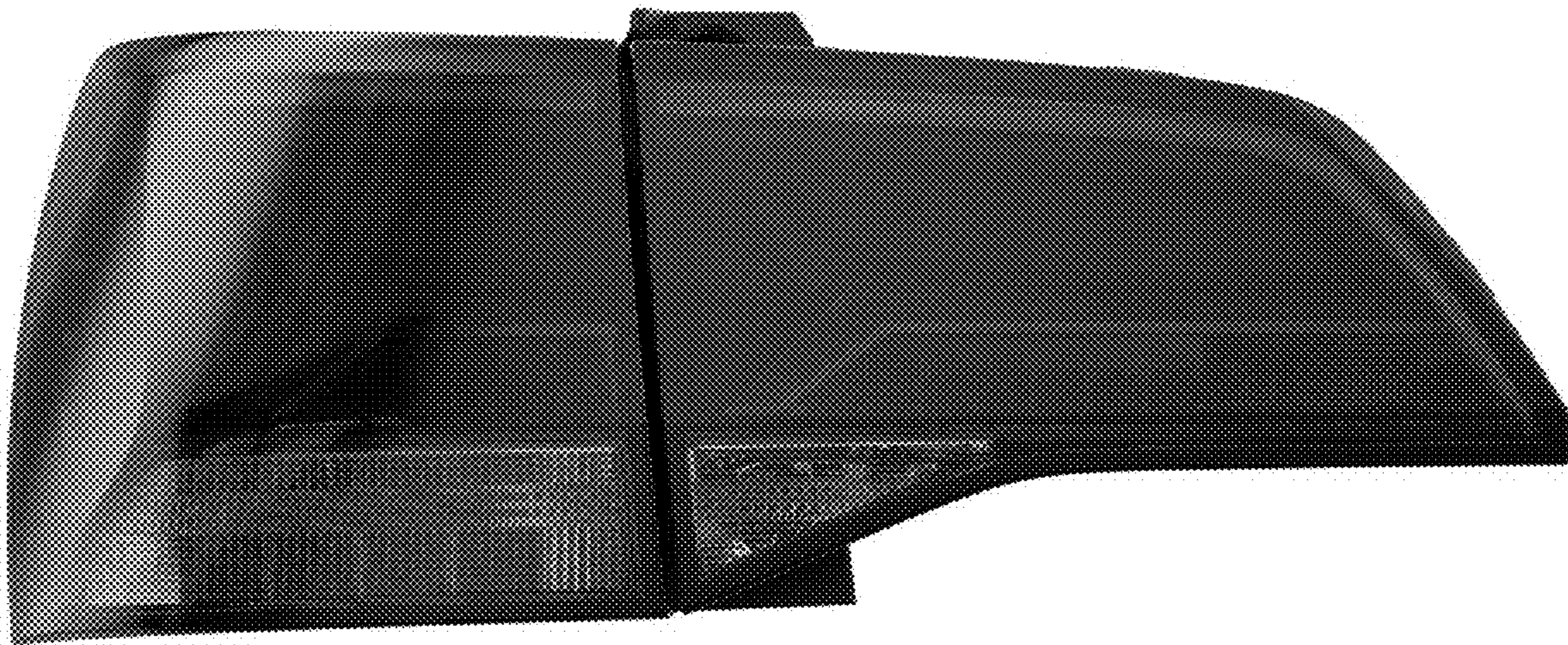

Fig. 4

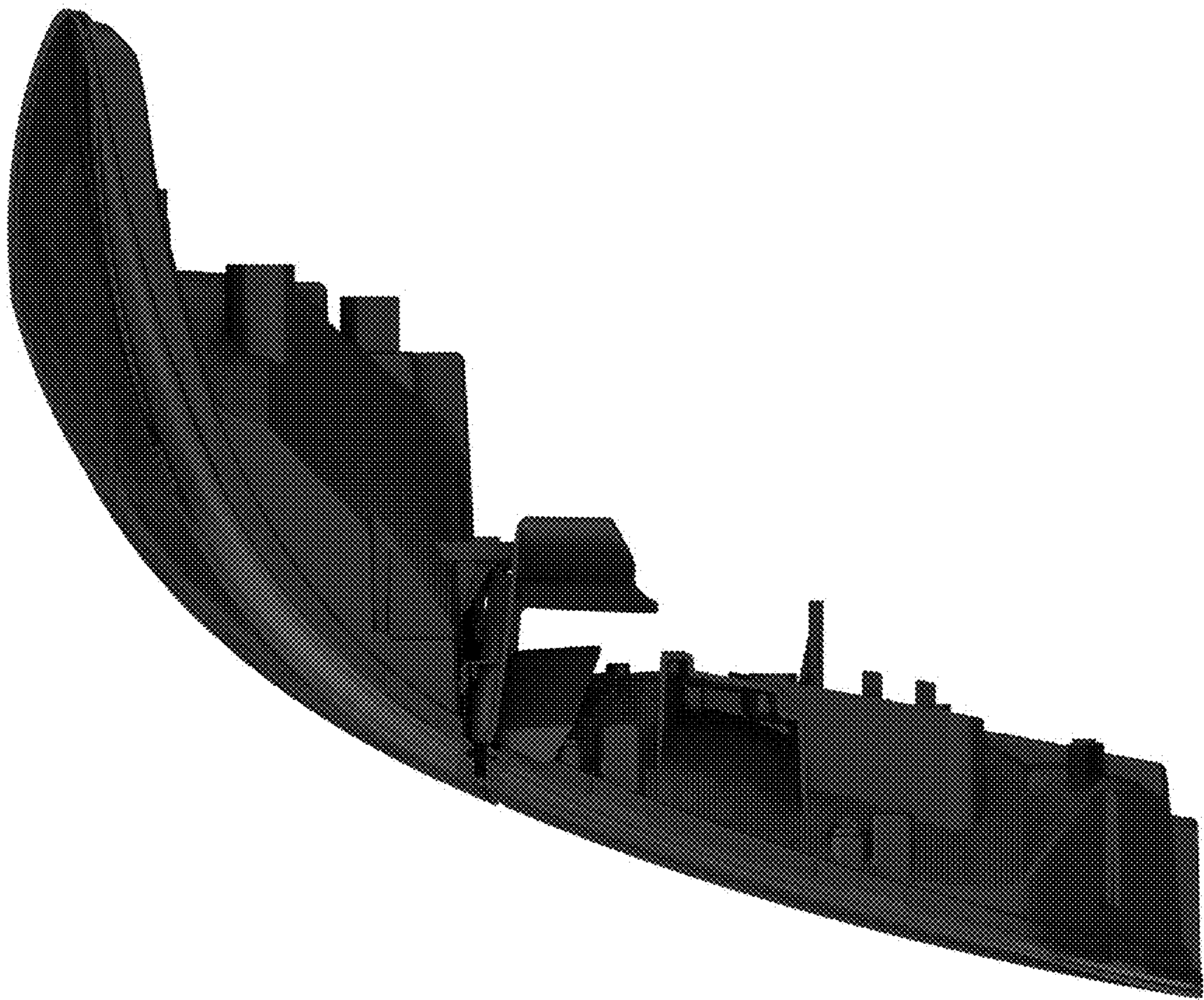

Fig. 5

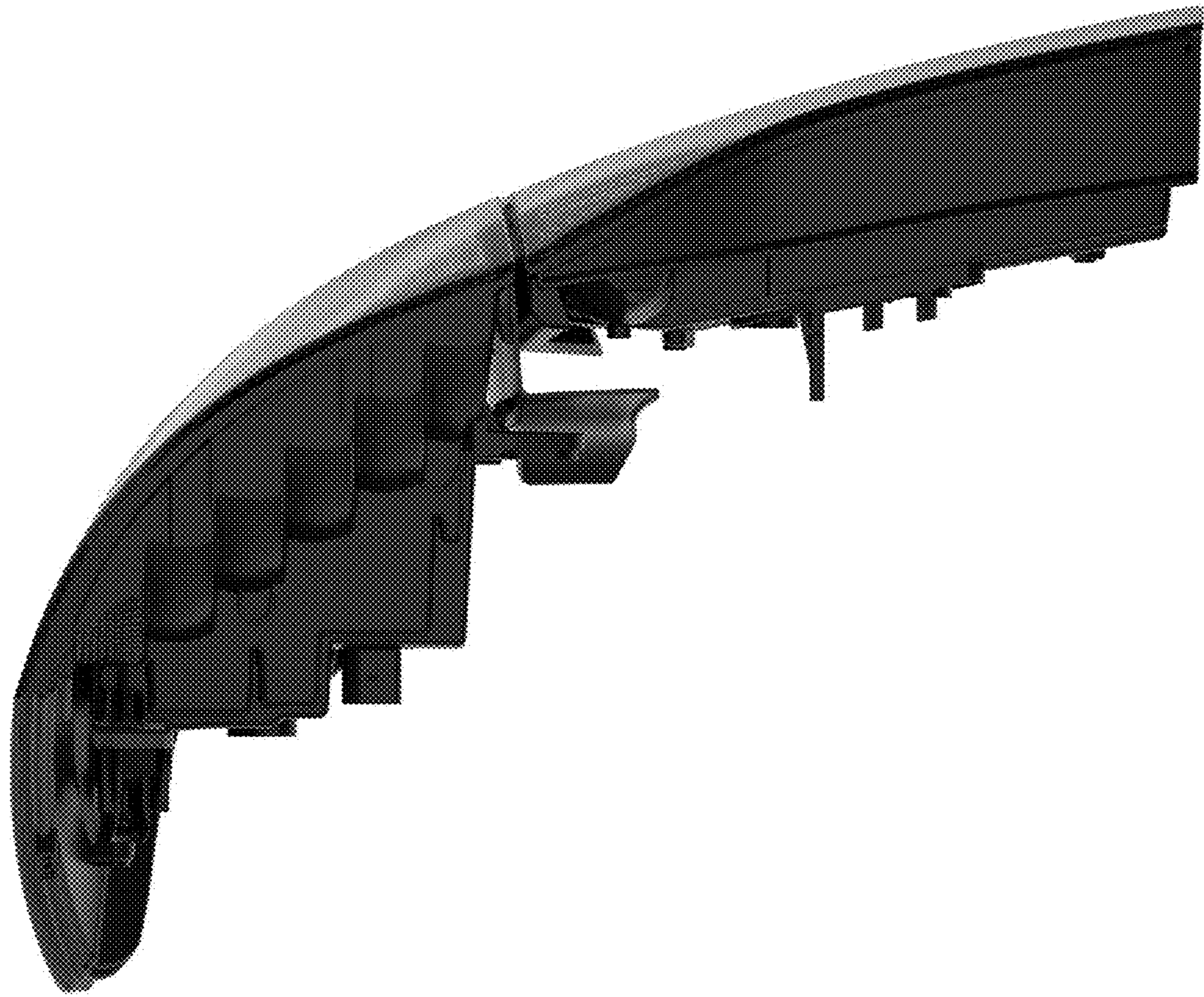

Fig. 6

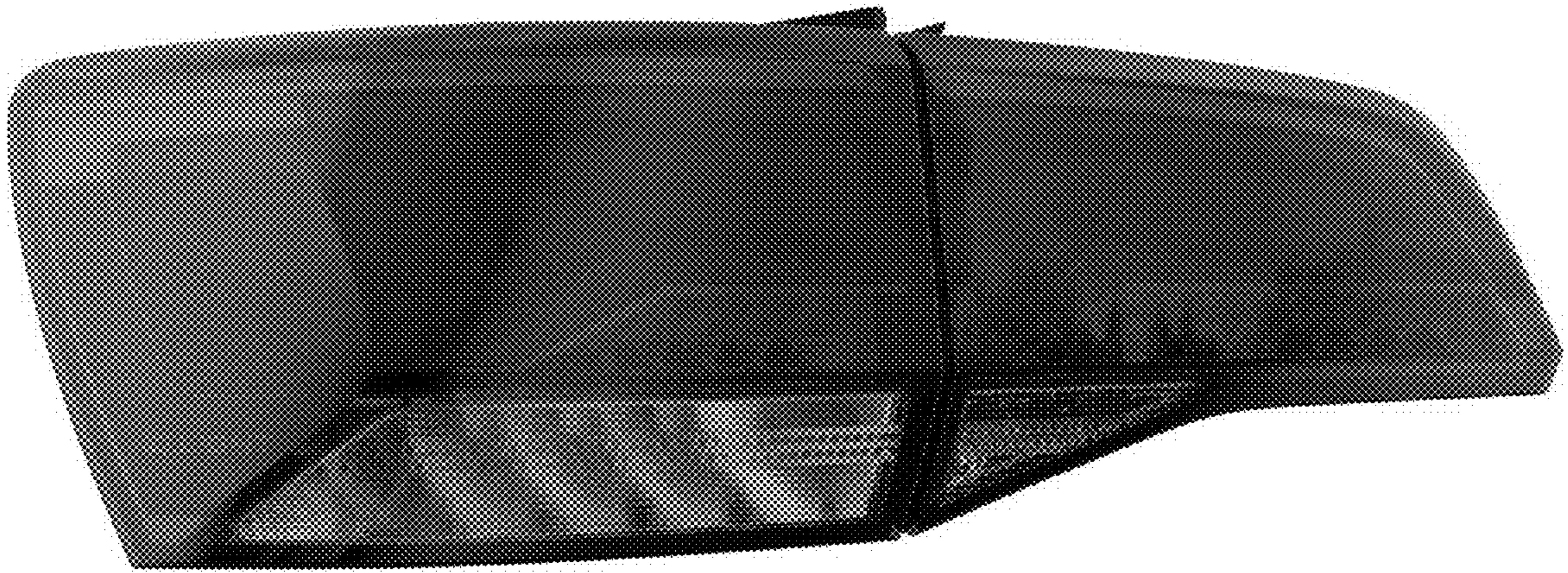

Fig. 7

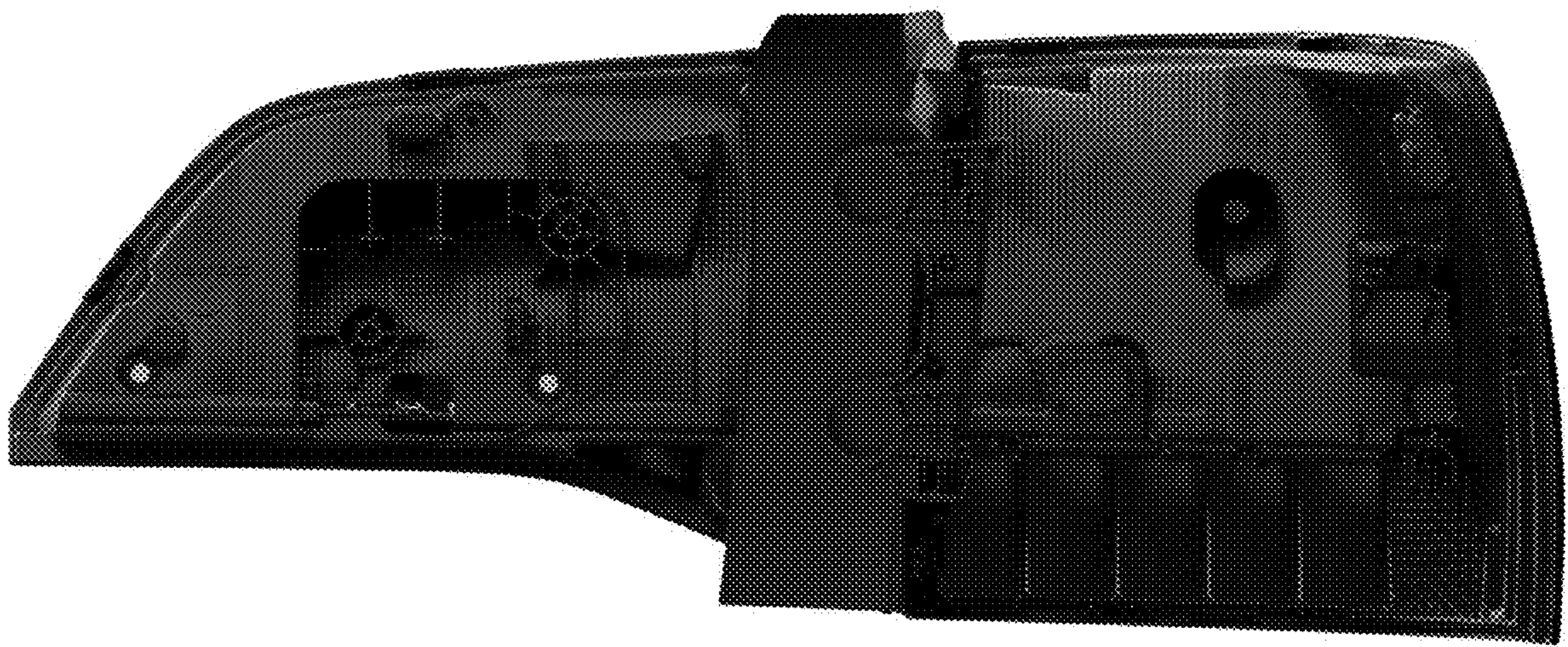

Fig. 8



Fig. 9

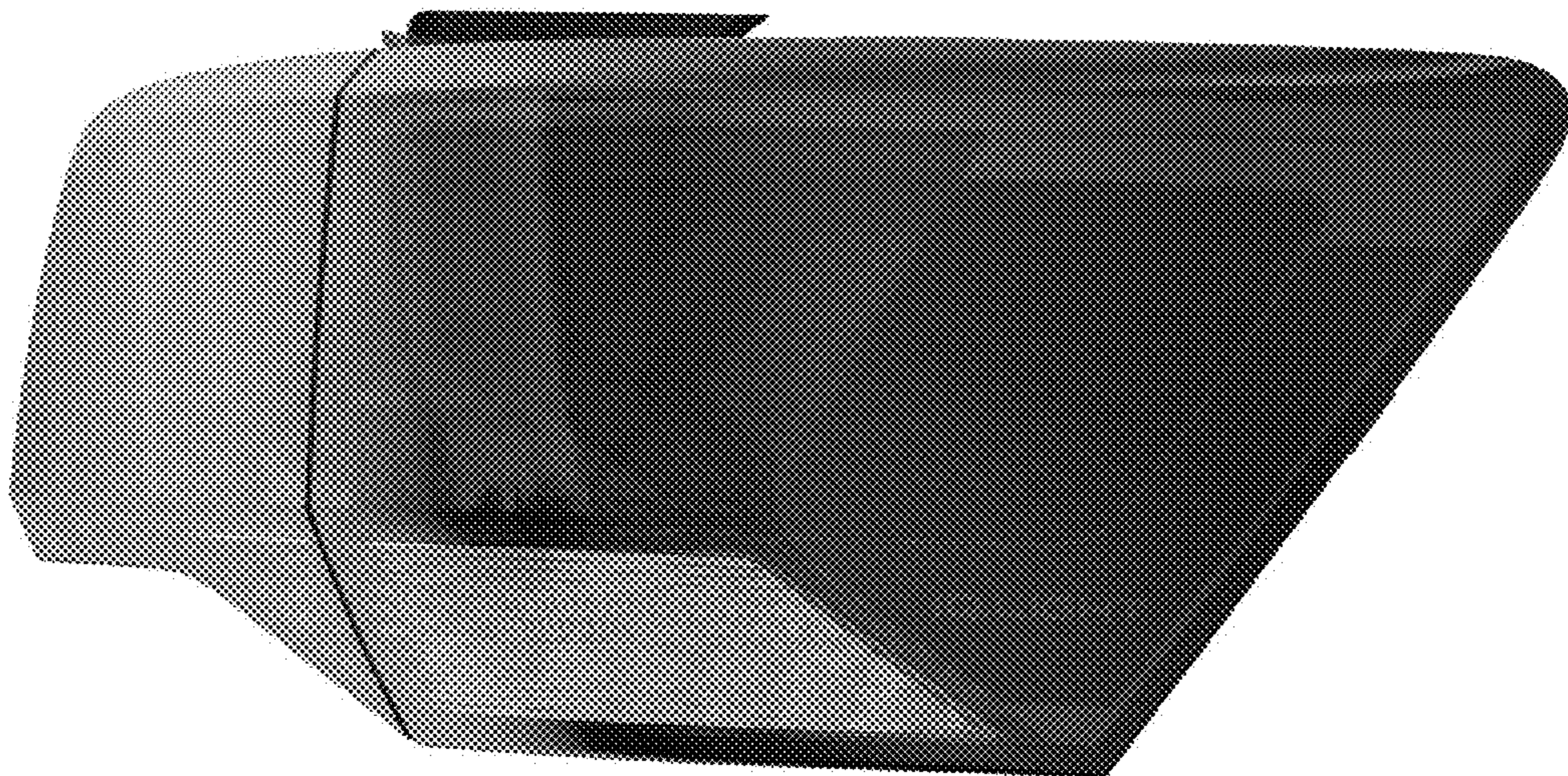

Fig. 10

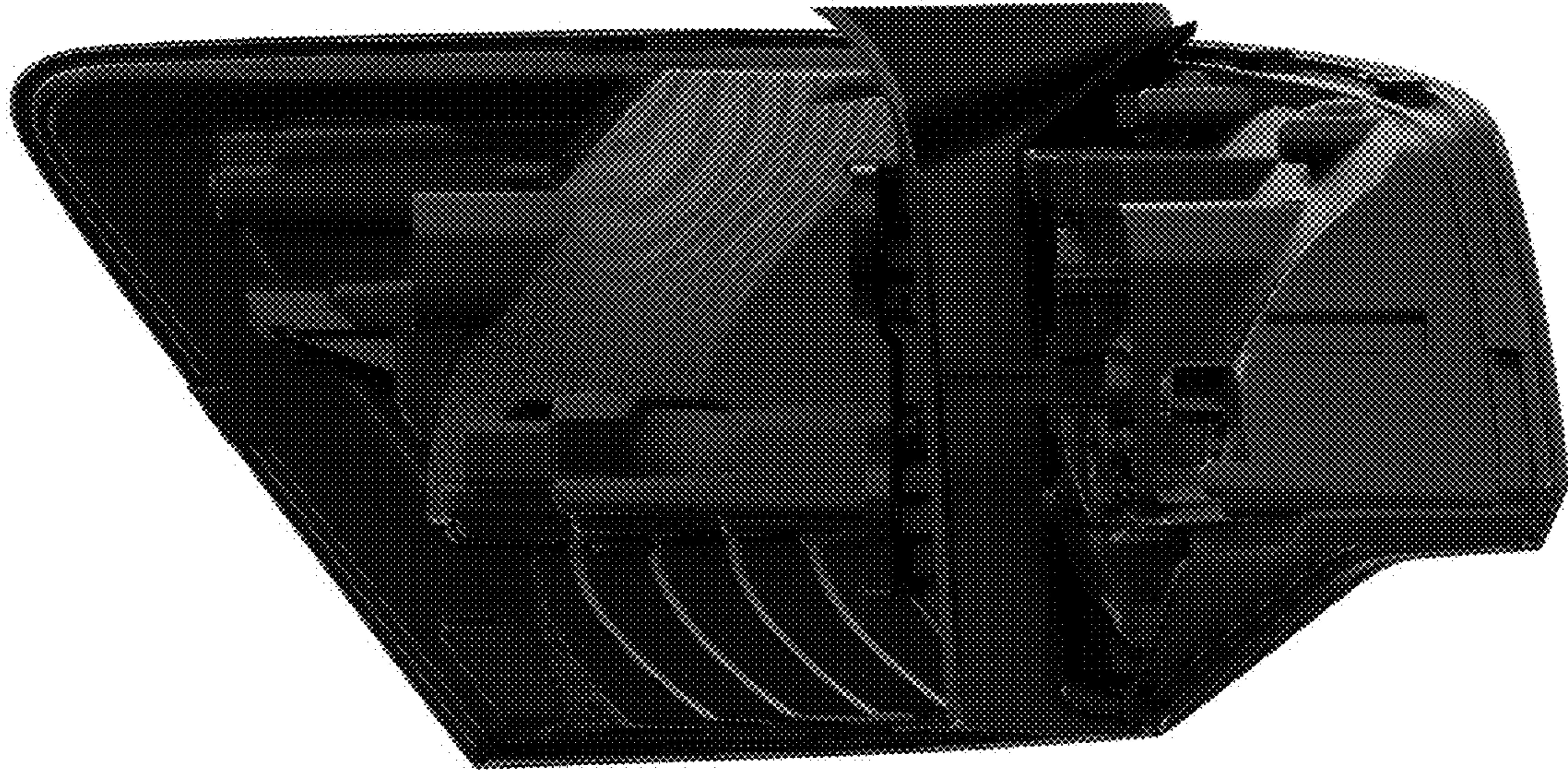

Fig. 11

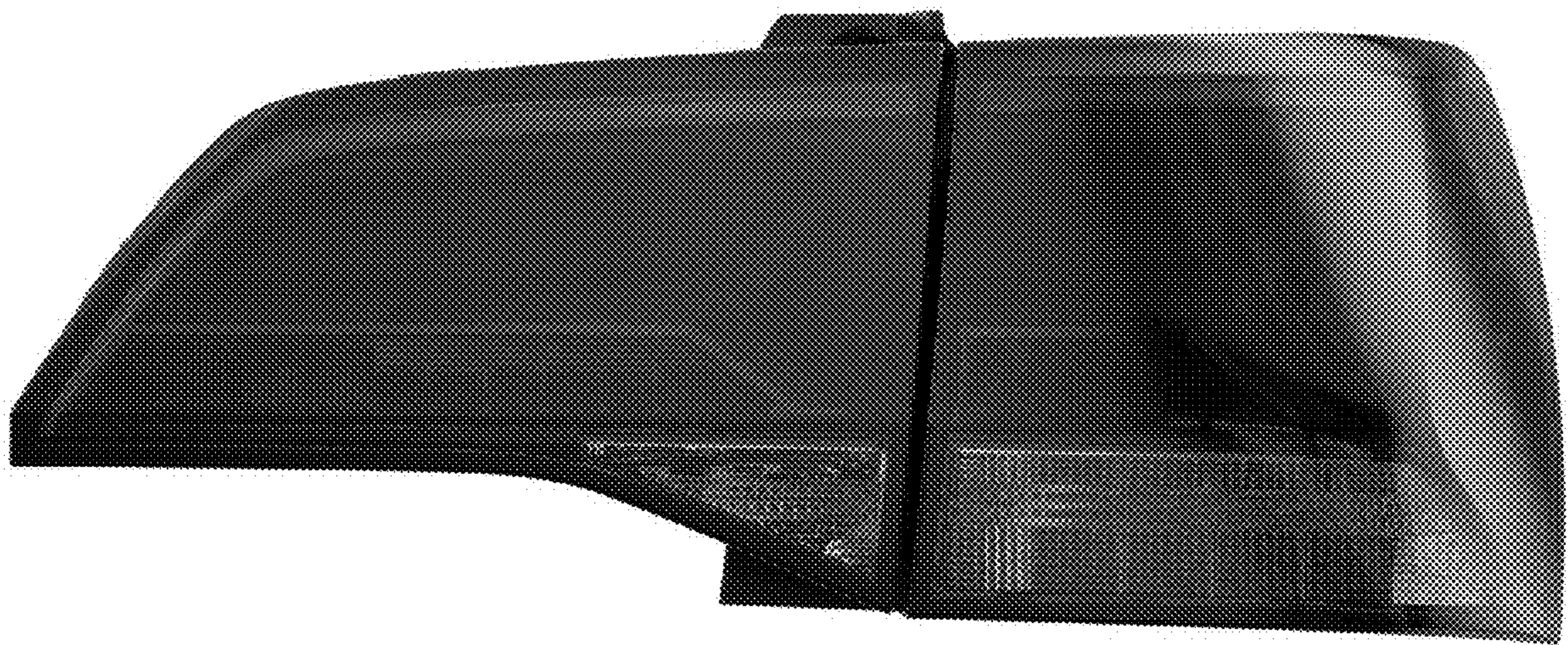

Fig. 12

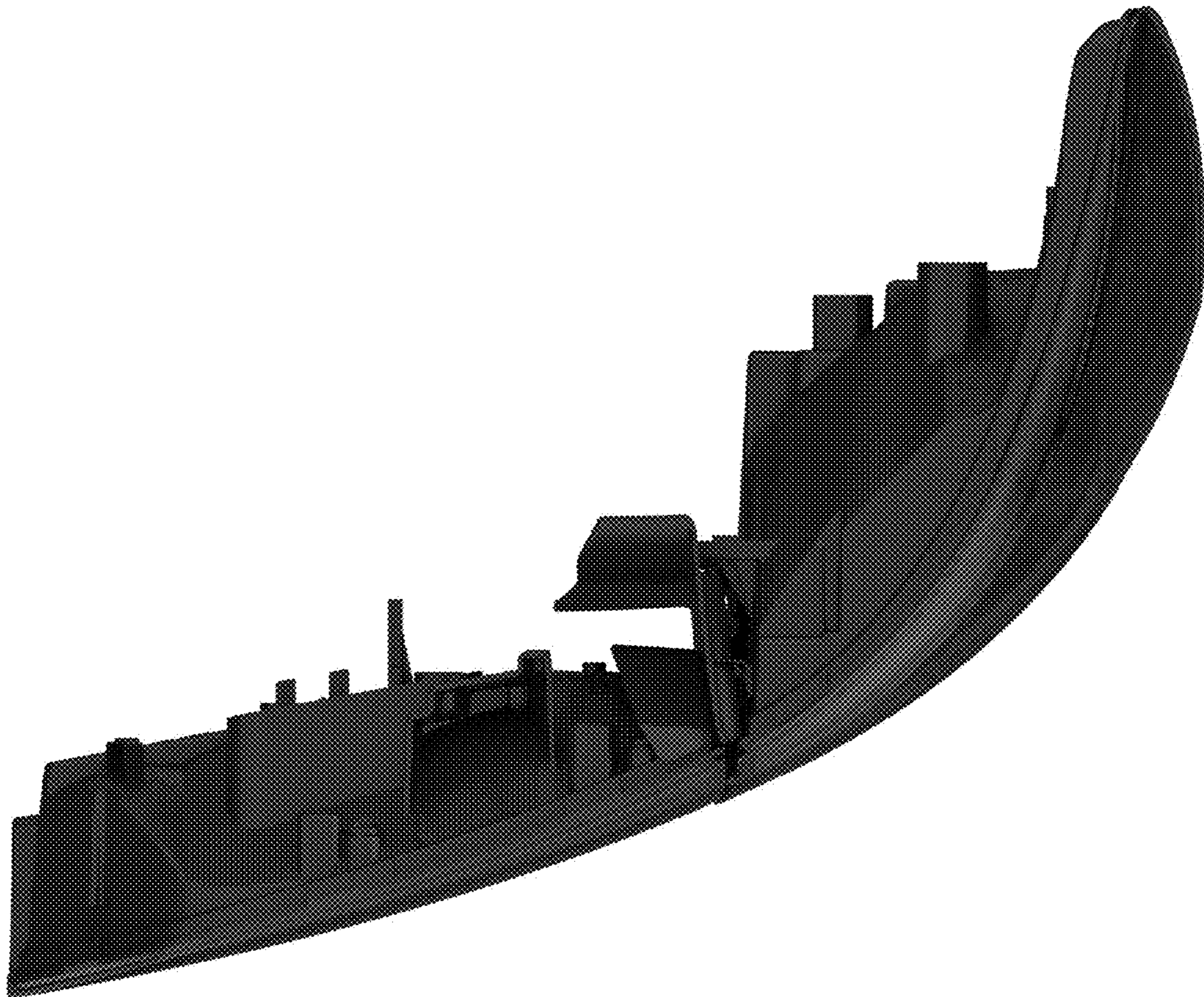

Fig. 13

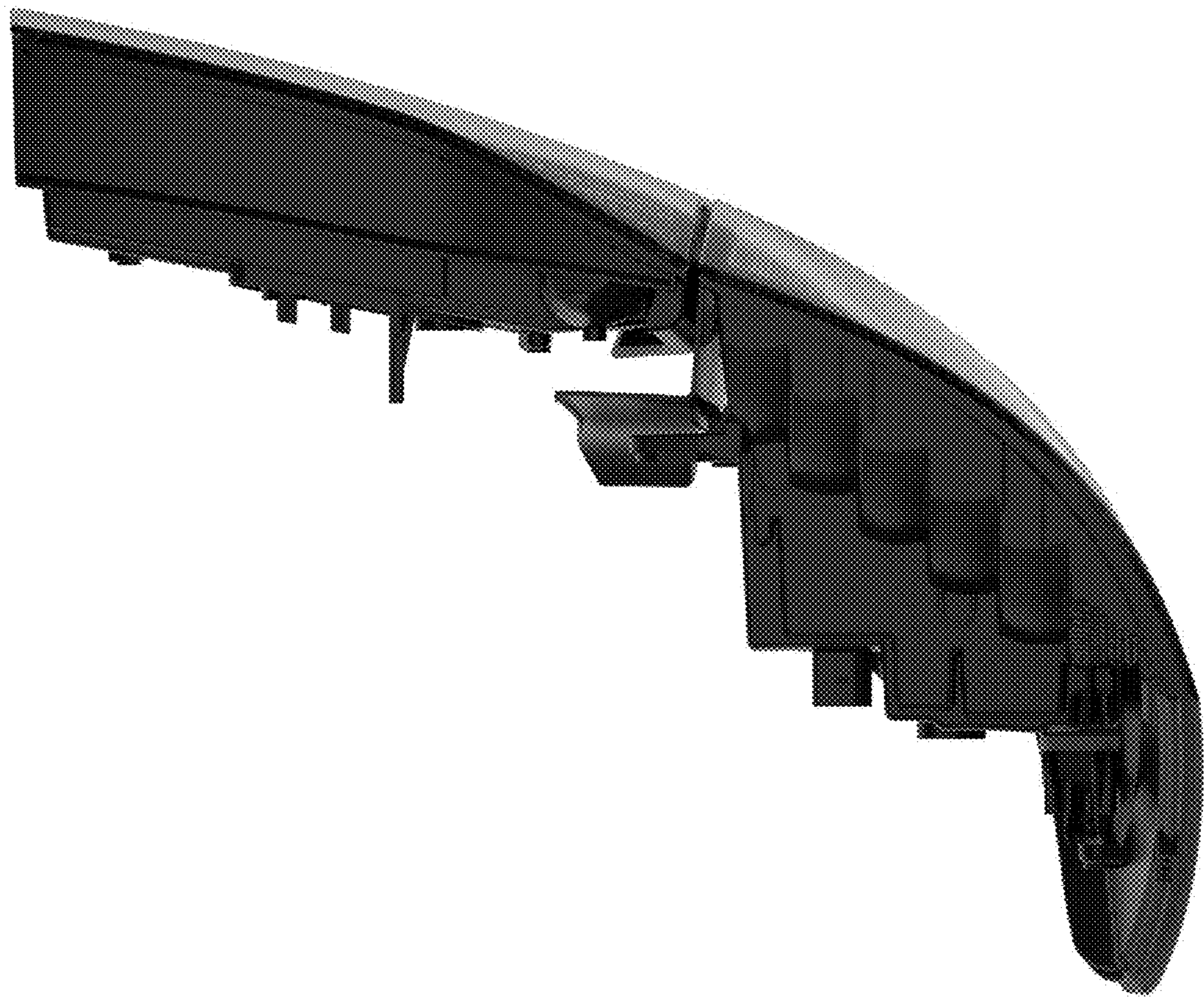

Fig. 14



Fig. 15

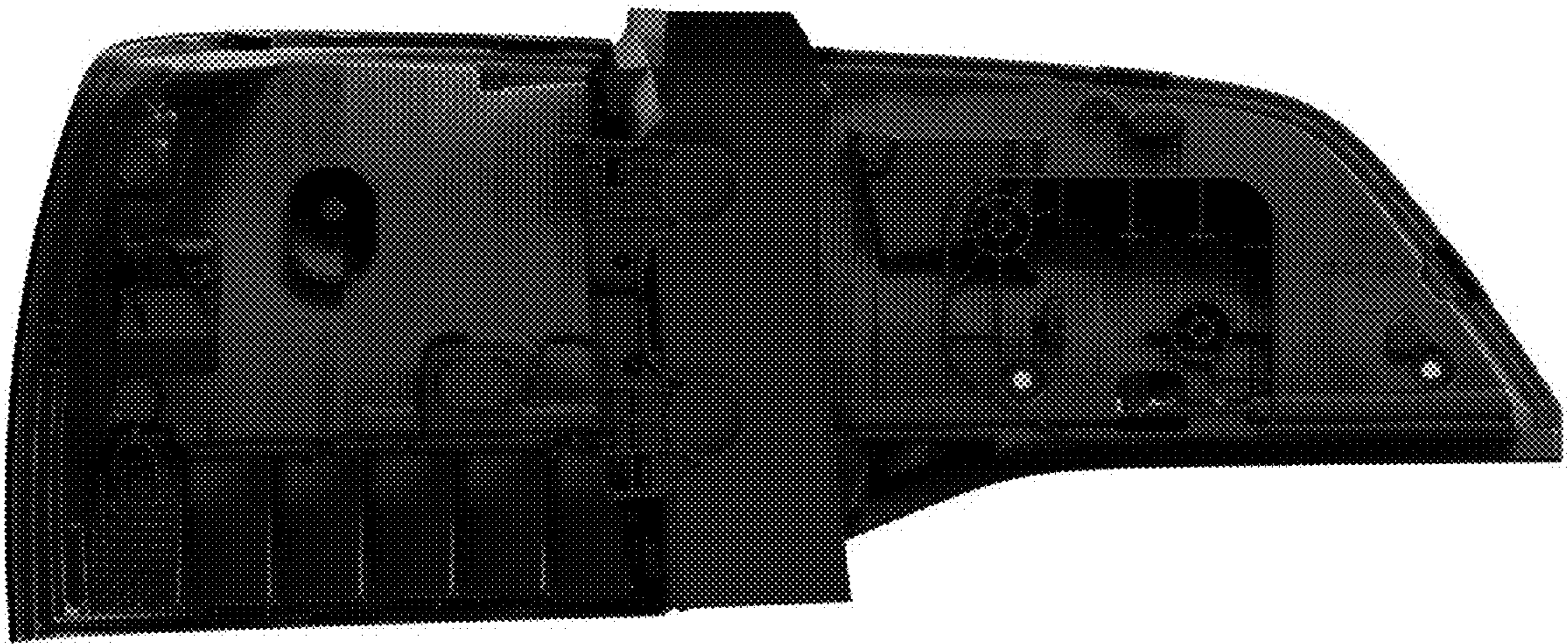

Fig. 16