



US00D983975S

(12) **United States Design Patent**
Yukita et al.

(10) **Patent No.:** **US D983,975 S**
(45) **Date of Patent:** **** Apr. 18, 2023**

(54) **HINGE FOR ORAL SLEEP APPLIANCE**

(71) Applicant: **Mitsui Chemicals, Inc.**, Tokyo (JP)

(72) Inventors: **Takashi Yukita**, Chiba (JP); **Yuki Iwabuchi**, Chiba (JP); **Akira Hasegawa**, Chiba (JP)

(**) Term: **15 Years**

(21) Appl. No.: **35/510,875**

(22) Filed: **Aug. 27, 2020**

(80) **Hague Agreement Data**

Int. Filing Date: **Aug. 27, 2020**
Int. Reg. No.: **DM/211459**
Int. Reg. Date: **Aug. 27, 2020**
Int. Reg. Pub. Date: **Dec. 4, 2020**

Related U.S. Application Data

(63) Continuation of application No. 29/725,757, filed on Feb. 27, 2020, now Pat. No. Des. 950,066.

(51) **LOC (14) Cl.** **24-02**

(52) **U.S. Cl.**
USPC **D24/180**

(58) **Field of Classification Search**

USPC D24/180, 181, 171
CPC A61C 7/125; A61C 7/08; A61C 13/34;
A61F 5/566; A61M 16/0488
See application file for complete search history.

(56) **References Cited**

U.S. PATENT DOCUMENTS

6,050,263 A * 4/2000 Choksi A61M 16/0488
128/207.14
7,611,352 B2 * 11/2009 Abels A61C 7/125
433/10
D685,098 S * 6/2013 Tompkins D24/180

D720,858 S * 1/2015 Burlon D24/181
D739,028 S * 9/2015 Stein D24/180
D872,281 S * 1/2020 Brauteseth D24/181
D932,626 S * 10/2021 Kim D24/181
D933,237 S * 10/2021 Sigurdsson D24/171
2011/0308531 A1 * 12/2011 Grosky A61F 5/566
128/848
2014/0352701 A1 * 12/2014 Ingemarsson-Matzen
A61F 5/566
128/848
2015/0101614 A1 * 4/2015 Quaka A61F 5/566
128/848
2015/0202075 A1 * 7/2015 Vincent A61F 5/566
128/848
2015/0216716 A1 * 8/2015 Anitua Aldecoa A61C 7/08
128/848
2016/0184129 A1 * 6/2016 Liptak A61F 5/566
128/848
2016/0270886 A1 * 9/2016 Schuler A61C 13/34
2020/0222227 A1 * 7/2020 Shim A61F 5/566

* cited by examiner

Primary Examiner — Rhea Shields

(57) **CLAIM**

The ornamental design for a hinge for oral sleep appliance, as shown and described.

DESCRIPTION

2.1 is a perspective view of hinge for oral sleep appliance;
2.2 is a front view thereof;
2.3 is a rear view thereof;
2.4 is a top view thereof;
2.5 is a bottom view thereof;
2.6 is a right view thereof;
2.7 is a left view thereof; and
2.8 is an enlarged view of **2.6**.

In the reproductions, the broken lines are for the purpose of illustrating portions of the hinge for oral sleep appliance and form no part of the claimed design.

1 Claim, 8 Drawing Sheets

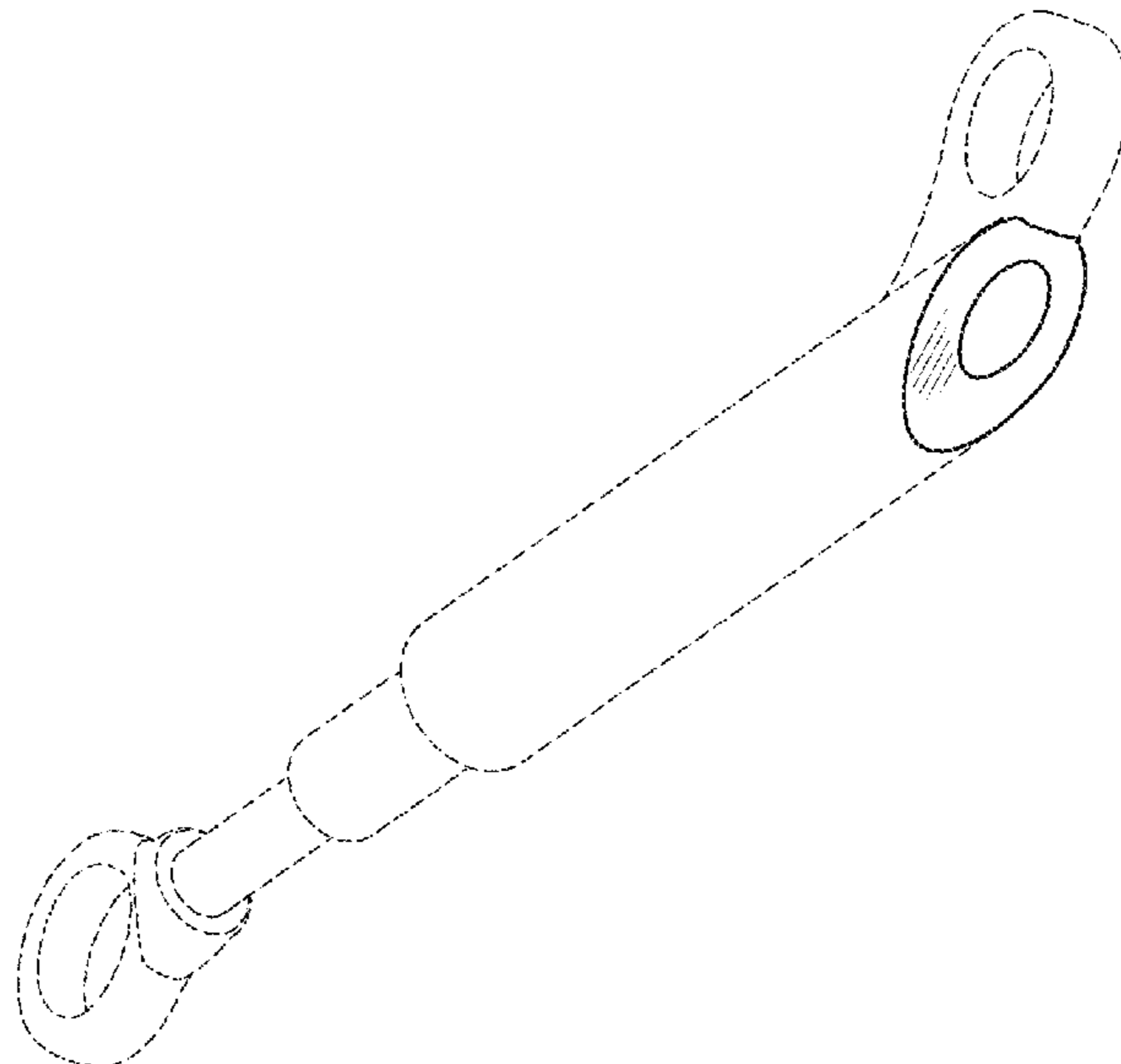

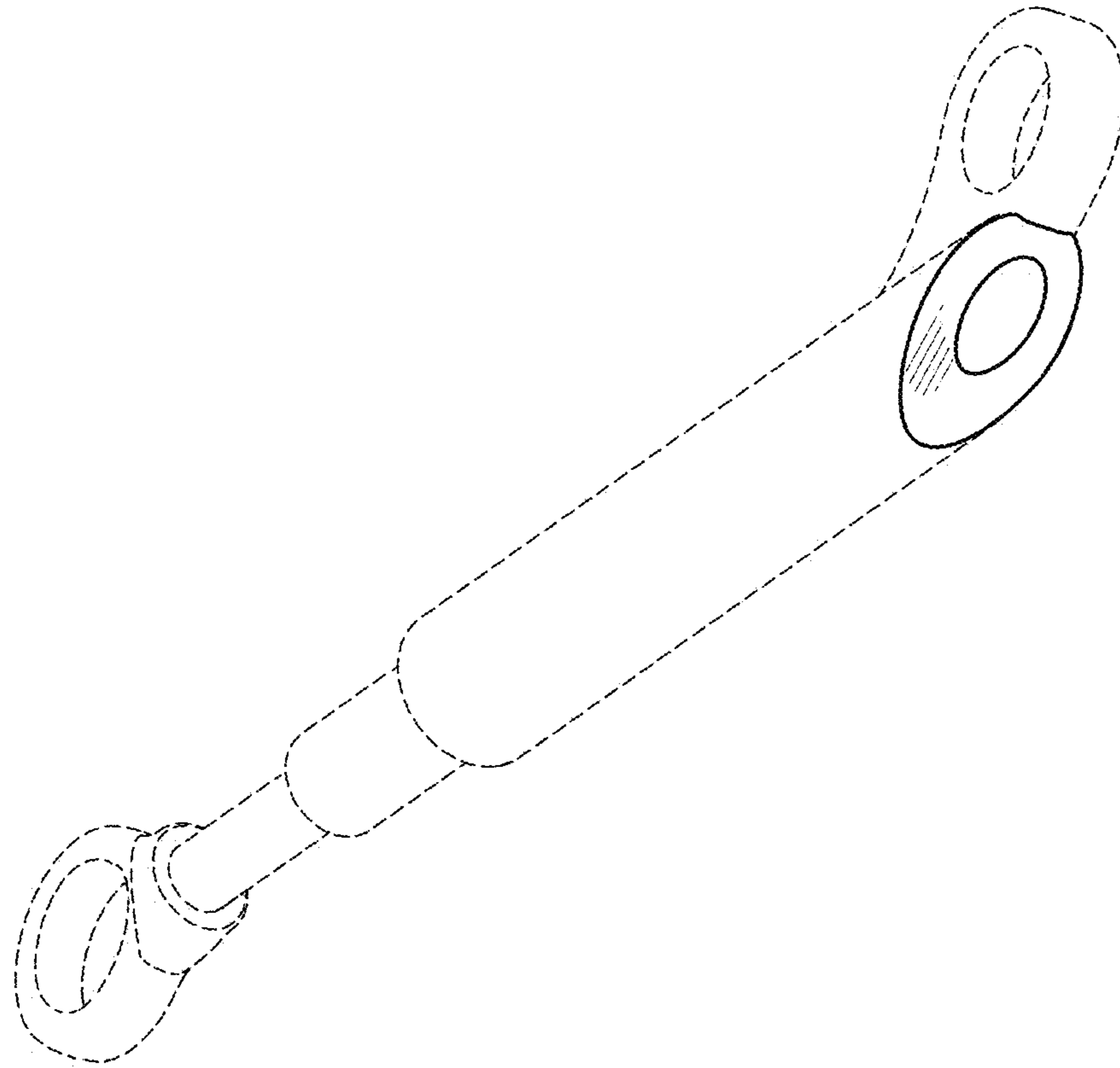

2.1

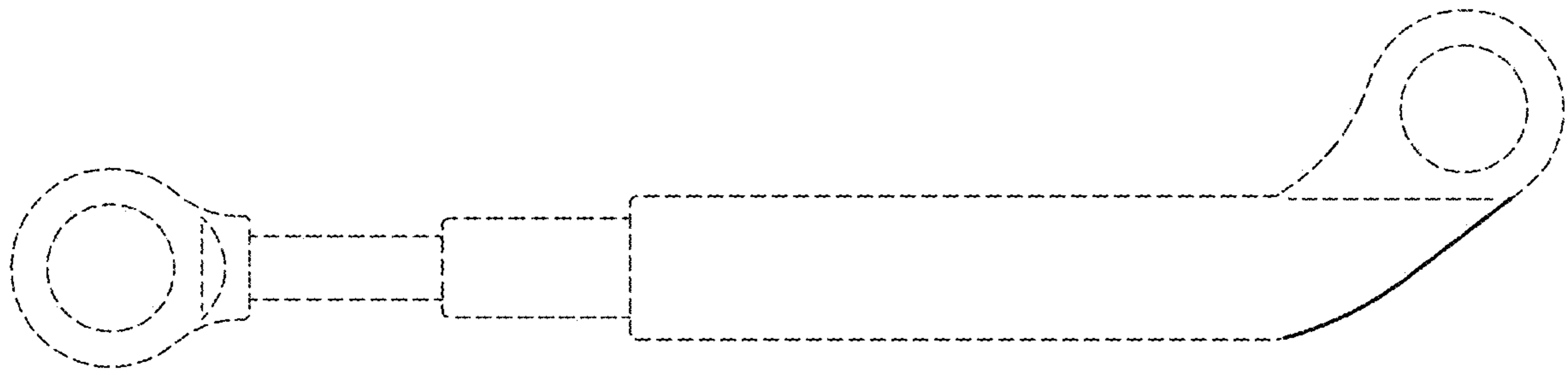

2.2

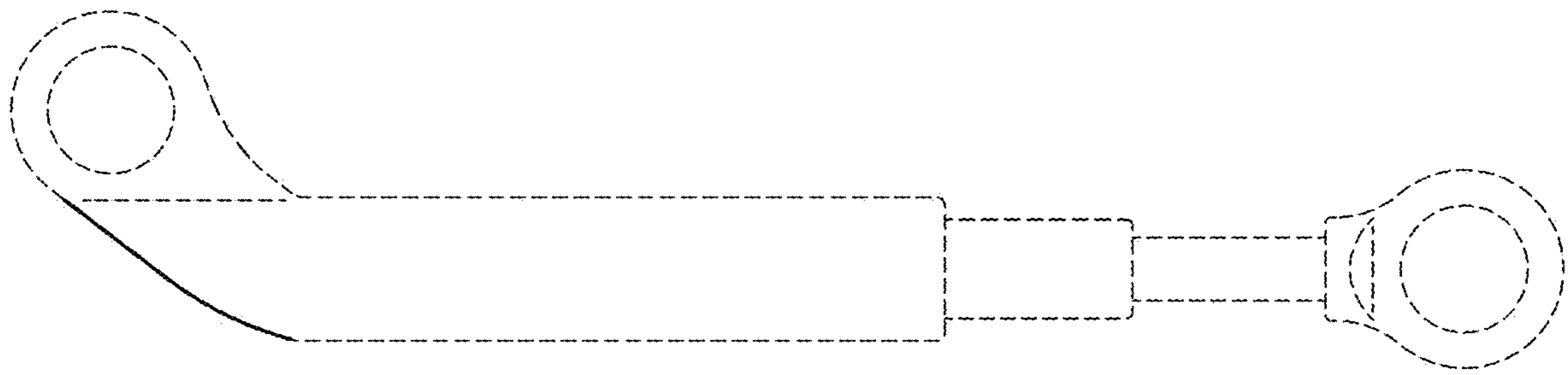

2.3



2.4



2.5

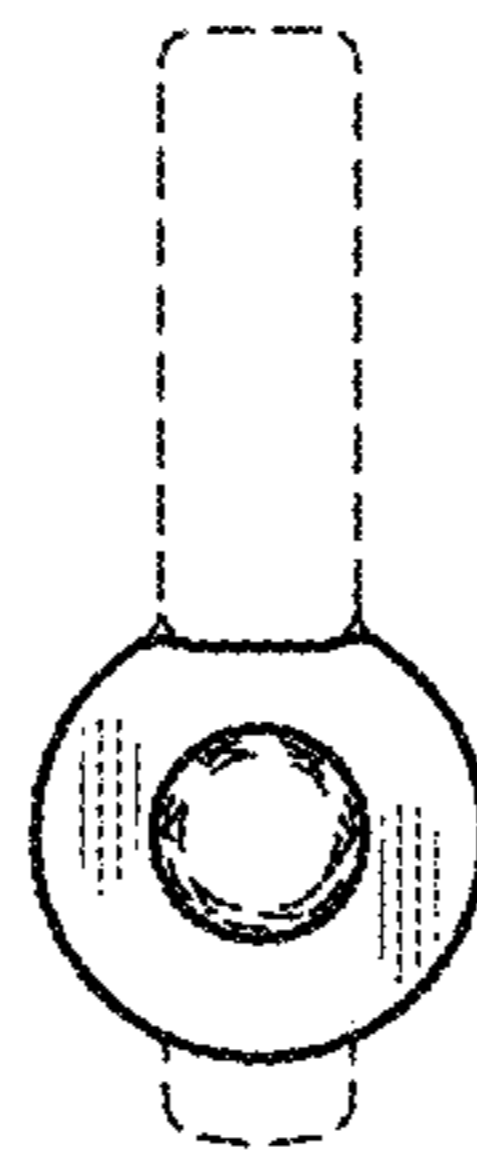

2.6

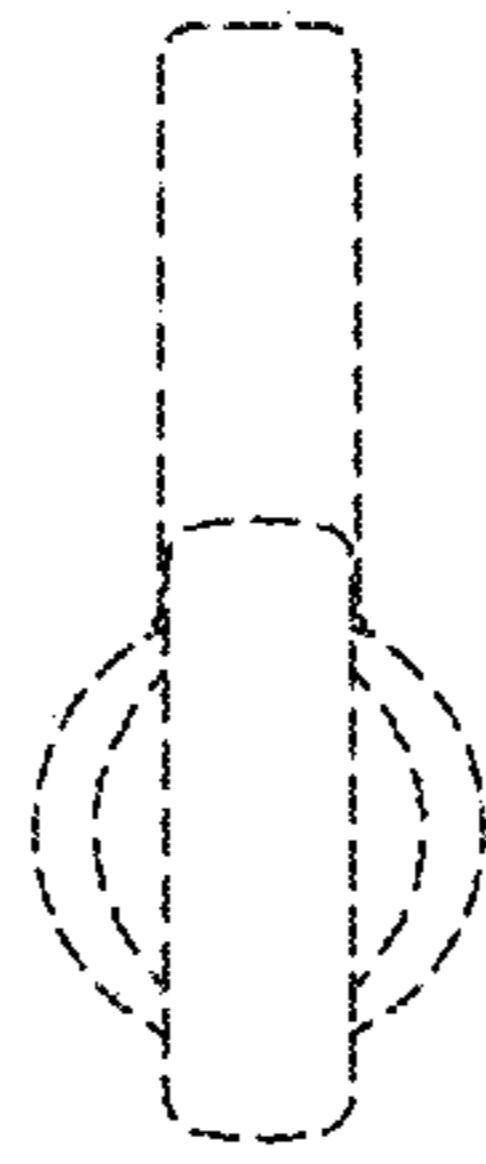

2.7

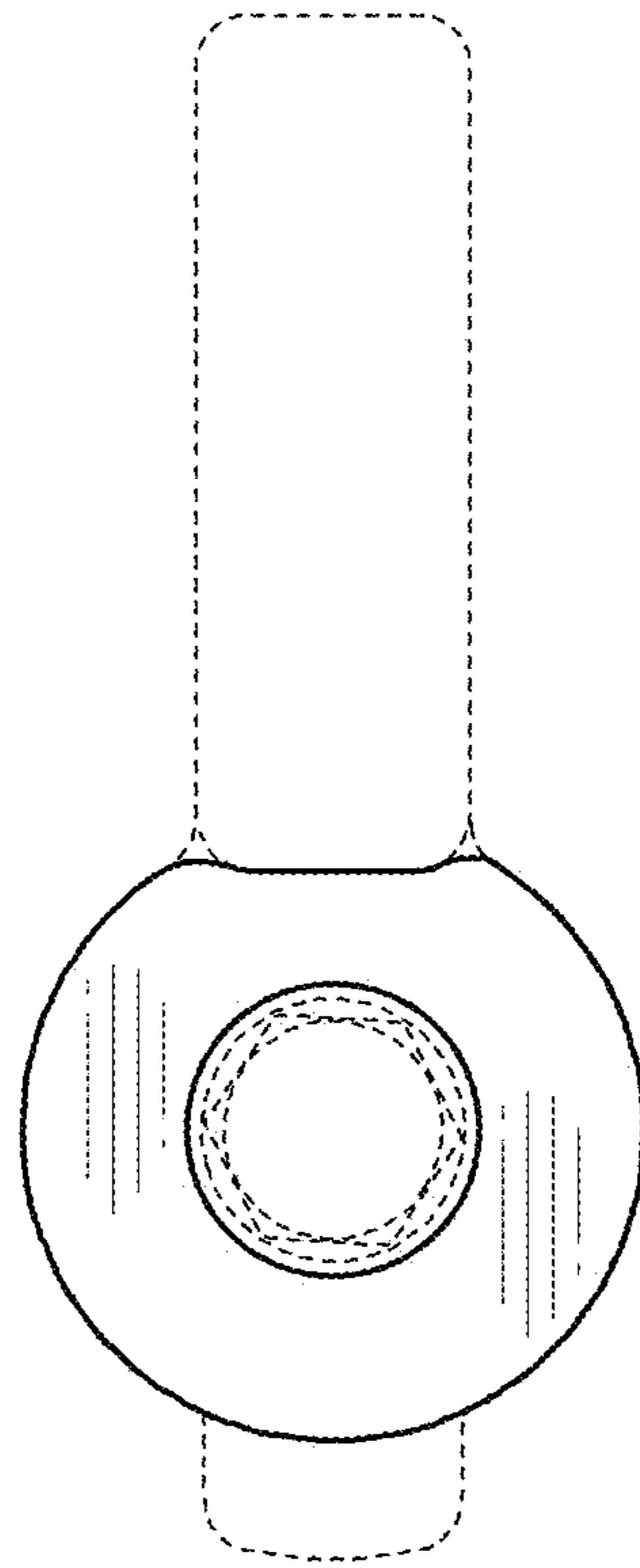

2.8