



US00D983966S

(12) **United States Design Patent**
Jones

(10) **Patent No.:** **US D983,966 S**
(45) **Date of Patent:** **** Apr. 18, 2023**

(54) **URINE COLLECTOR**

(71) Applicant: **Abigail Jones**, Tuscaloosa, AL (US)

(72) Inventor: **Abigail Jones**, Tuscaloosa, AL (US)

(**) Term: **15 Years**

(21) Appl. No.: **29/781,178**

(22) Filed: **Apr. 28, 2021**

Related U.S. Application Data

(63) Continuation of application No. 17/064,228, filed on Oct. 6, 2020, now Pat. No. 11,452,508.

(51) **LOC (14) Cl.** **24-04**

(52) **U.S. Cl.**
USPC **D24/122**

(58) **Field of Classification Search**
USPC D24/117, 121–123, 127, 128, 224;
D7/691, 700; D9/523, 528, 572;
D23/200, 302, 303, 309, 295
(Continued)

(56) **References Cited**

U.S. PATENT DOCUMENTS

1,928,170 A * 9/1933 Dwork A61F 5/455
4/144.4
D252,889 S * 9/1979 Hempstead D23/302
(Continued)

FOREIGN PATENT DOCUMENTS

CA 203936 * 11/2022

OTHER PUBLICATIONS

Biodegradable / Compostable Disposable Pulp Medical Products, Degradable Pulp Medical Series, [Post date unknown], [Site seen Feb. 8, 2023], Seen at URL: <https://www.allgreenproduct.com/degradable-pulp-medical-series> (Year: 2023).*

(Continued)

Primary Examiner — Natasha Vujcic

Assistant Examiner — Gilbert B Ford

(74) *Attorney, Agent, or Firm* — C. Brandon Browning;
Maynard, Cooper & Gale, PC

(57) **CLAIM**

I claim, the ornamental design for a urine collector, as shown and described.

DESCRIPTION

FIG. 1 is a top perspective of the urine collector in a closed configuration.

FIG. 2 is a bottom perspective of the urine collector of FIG. 1 in the closed configuration.

FIG. 3 is a top plan view of the urine collector of FIG. 1 in the closed configuration.

FIG. 4 is a bottom view of the urine collector of FIG. 1 in the closed configuration.

FIG. 5 is a first side elevational view of the urine collector of FIG. 1 in the closed configuration, which is a mirror image of an opposing second side thereof.

FIG. 6 is a first end elevational view of the urine collector of FIG. 1 in the closed configuration.

FIG. 7 is a second end elevational view of the urine collector of FIG. 1 in the closed configuration.

FIG. 8 is a perspective view of the urine collector of FIG. 1 in a partially open configuration.

FIG. 9 is a top view of the urine collector of FIG. 1 in an open configuration.

FIG. 10 is a bottom view of the urine collector of FIG. 9 in the open configuration.

FIG. 11 is an elevational view of the first side of the urine collector of FIG. 1 in a partially open configuration, which is a mirror image of the opposing second side thereof.

FIG. 12 is a first end elevational view of the urine collector of FIG. 1 in an open configuration; and,

FIG. 13 is a second end elevational view of the urine collector of FIG. 1 in an open configuration.

The broken lines in the drawings illustrate portions of the urine collector and form no part of the claimed design.

1 Claim, 7 Drawing Sheets

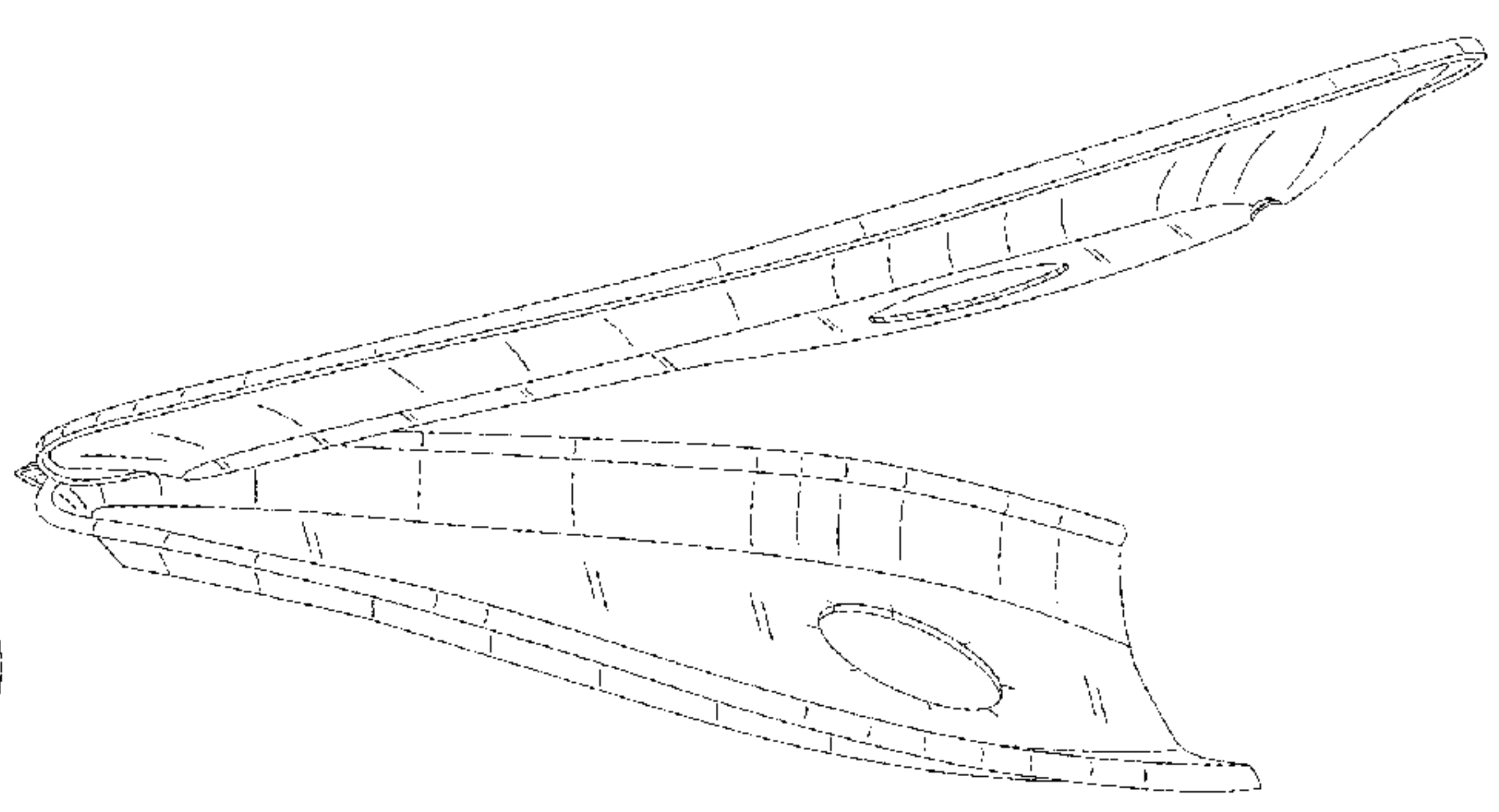
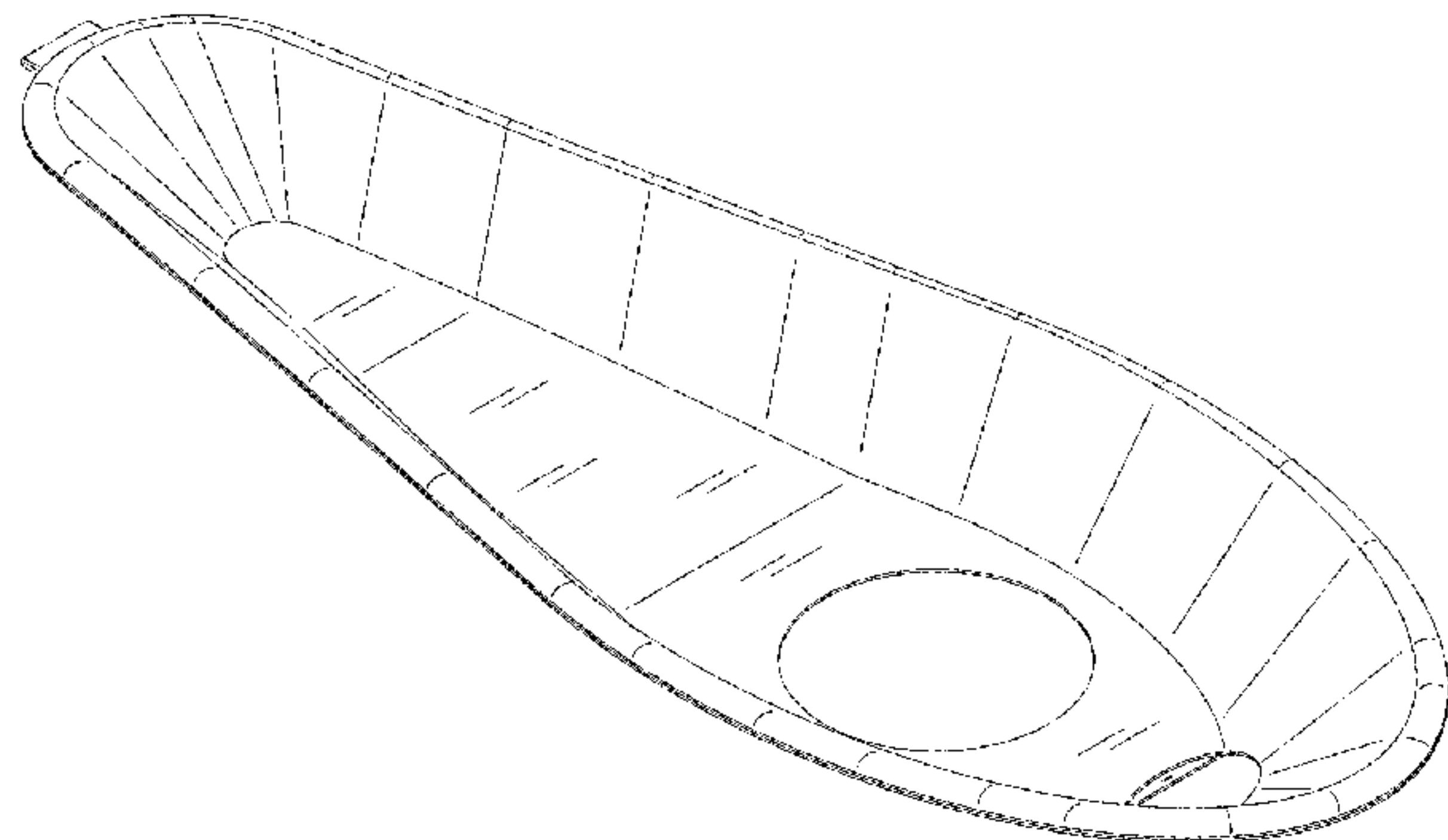

(58) **Field of Classification Search**

CPC A61G 9/00; A61G 9/006; A61G 9/003
See application file for complete search history.

(56) **References Cited**

U.S. PATENT DOCUMENTS

D290,880 S * 7/1987 Blanton D7/700
D303,573 S * 9/1989 Parrish D24/122
D304,496 S * 11/1989 Thomas D24/117
4,936,838 A * 6/1990 Cross A61F 5/455
600/574
D607,995 S * 1/2010 Miller D24/122
D898,906 S * 10/2020 Reaux D24/123
11,452,508 B2 * 9/2022 Jones C08L 101/16
2017/0273843 A1 * 9/2017 Cailleateau A61G 7/05769
2022/0031290 A1 * 2/2022 Weed A61B 10/007

OTHER PUBLICATIONS

Stainless steel bedpan 20150, Inmoclinc, medicalexpo.com, [Post date May 13, 2021], [Site seen Feb. 8, 2023], Seen at URL: <https://www.medicalexpo.com/prod/inmoclinc/product-68863-949283.html> (Year: 2021).*

* cited by examiner

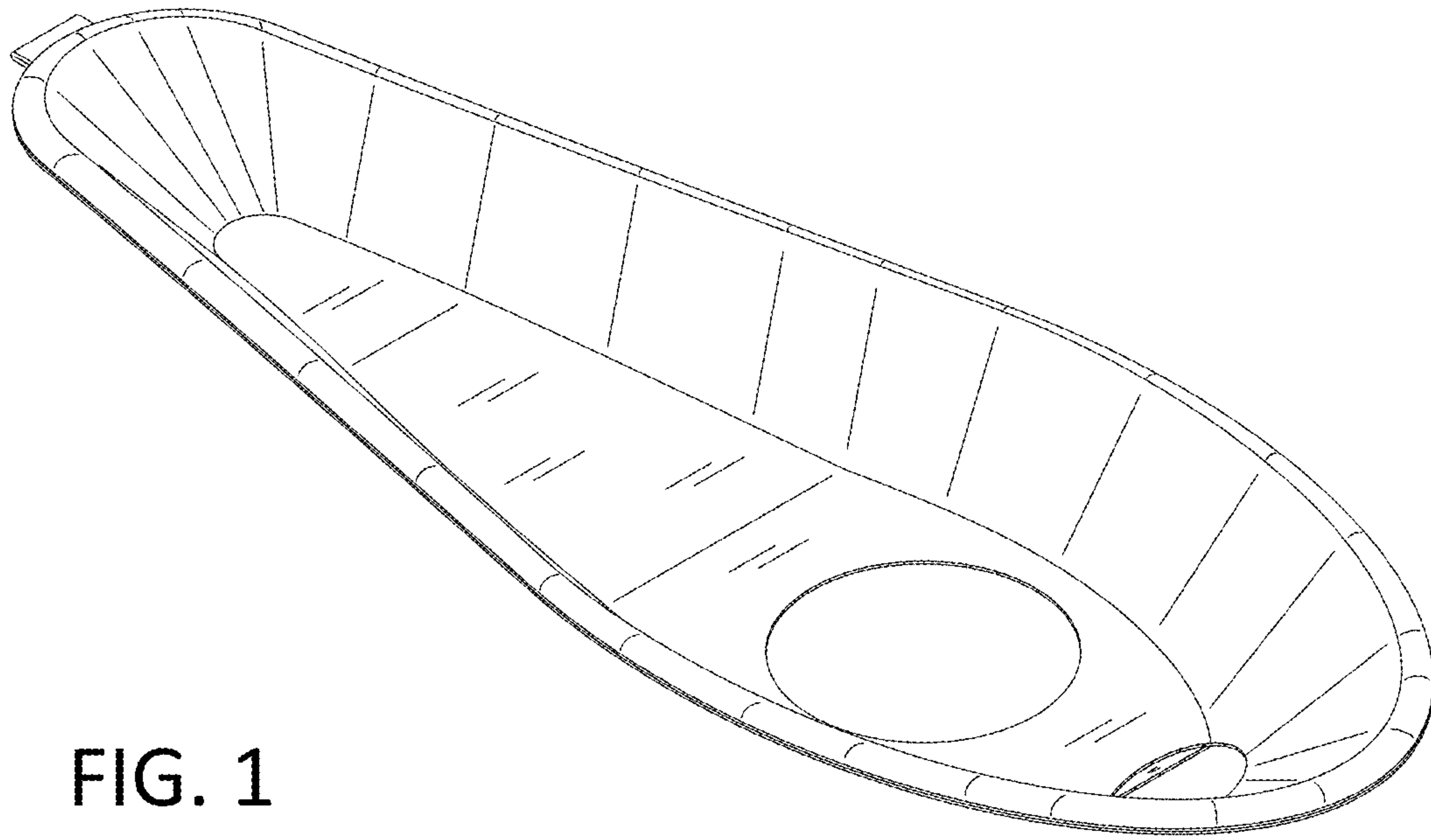

FIG. 1

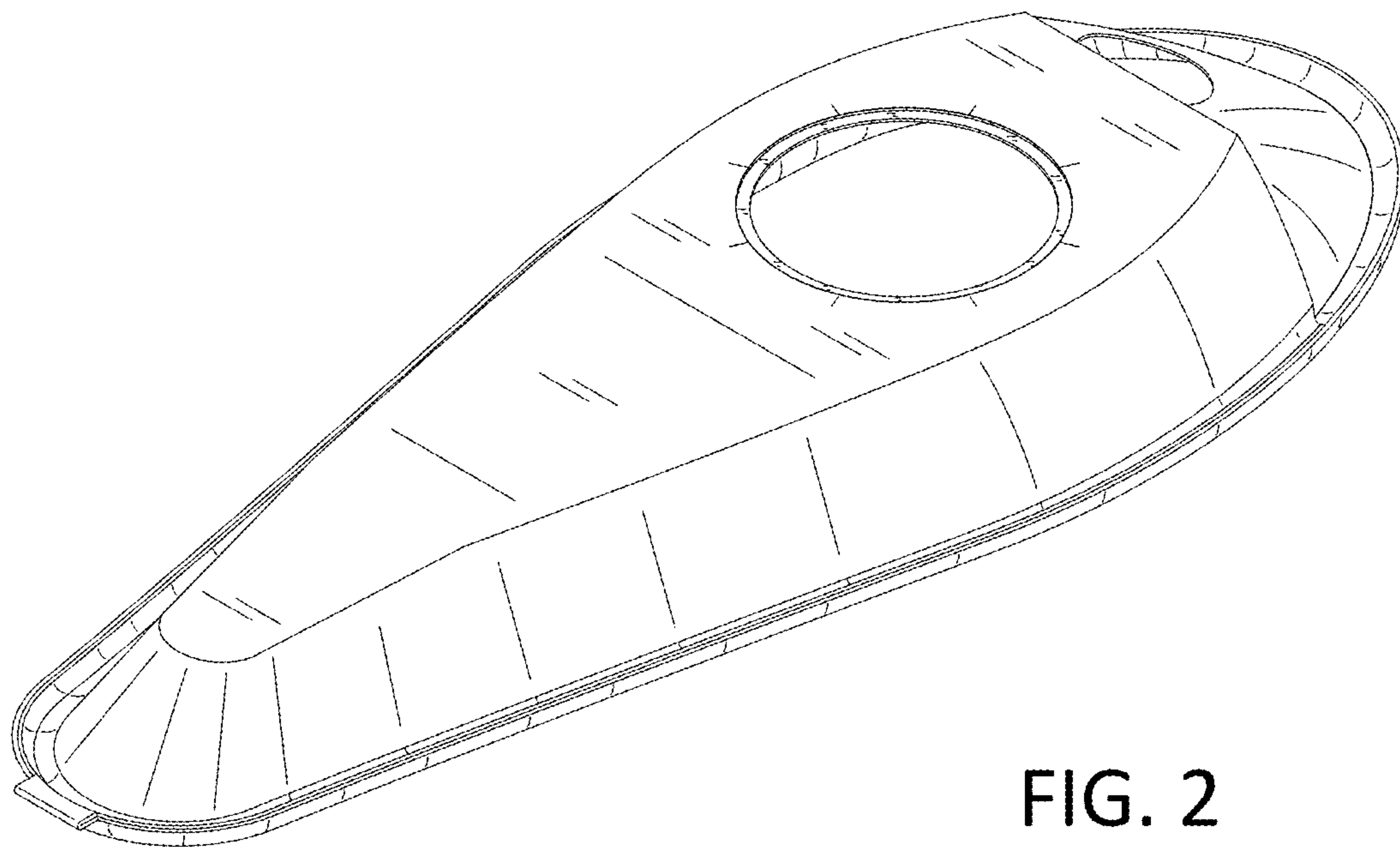

FIG. 2

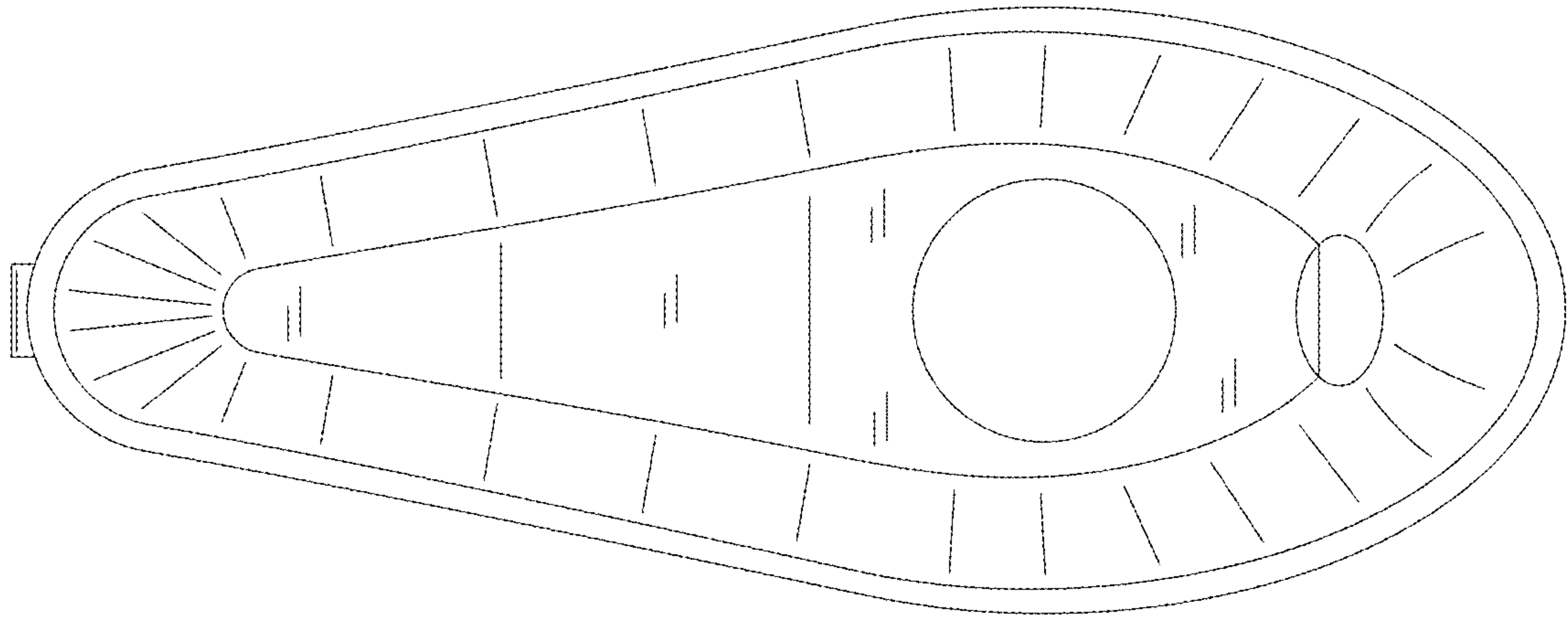

FIG. 3

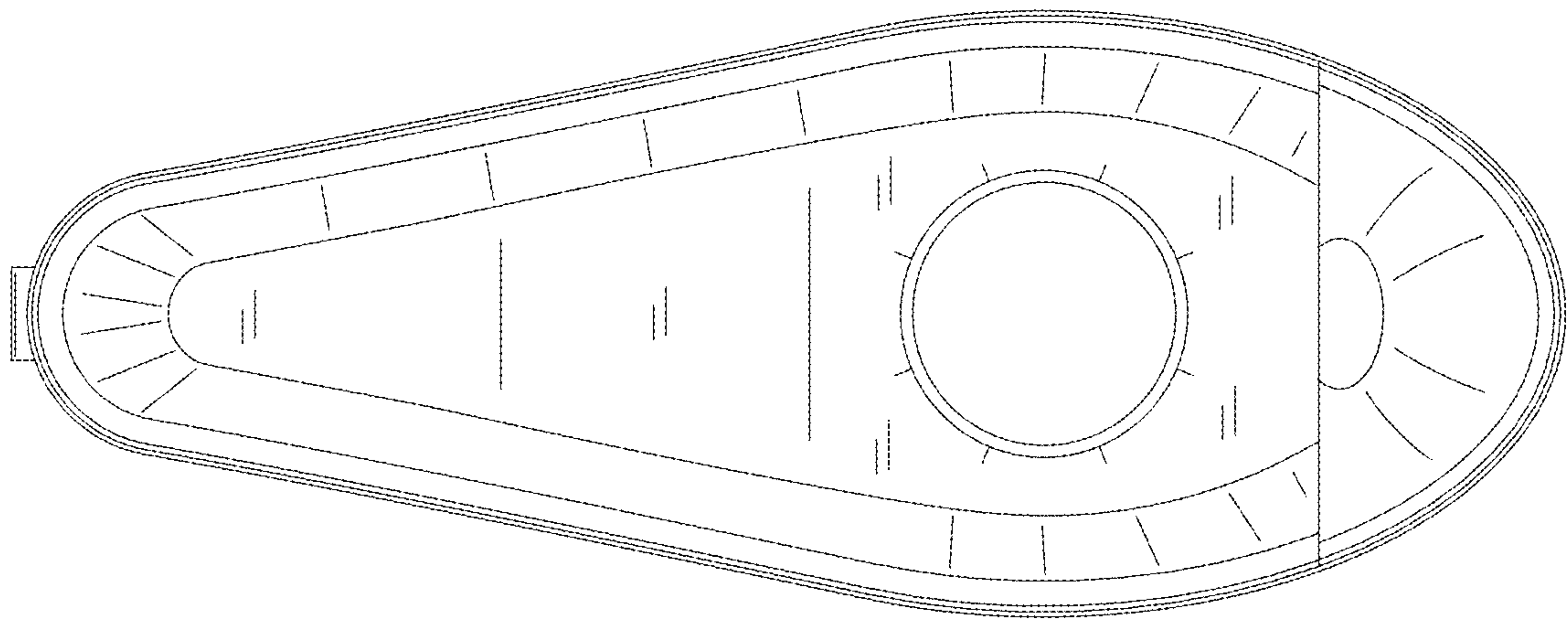

FIG. 4

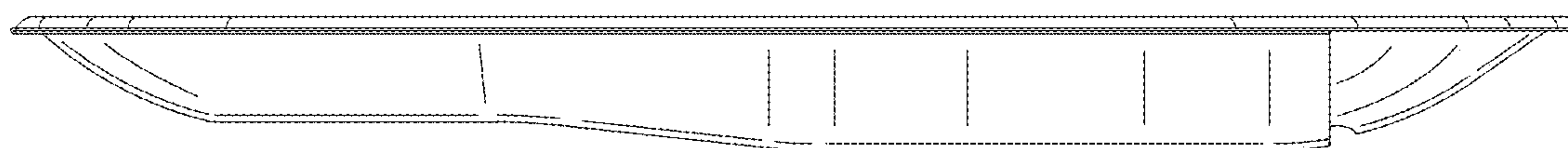

FIG. 5

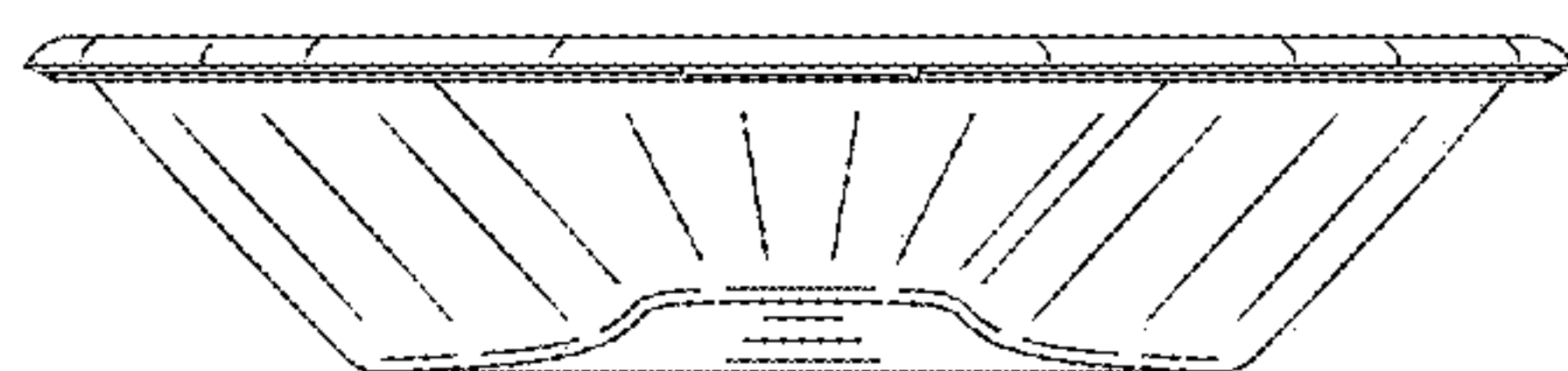

FIG. 6

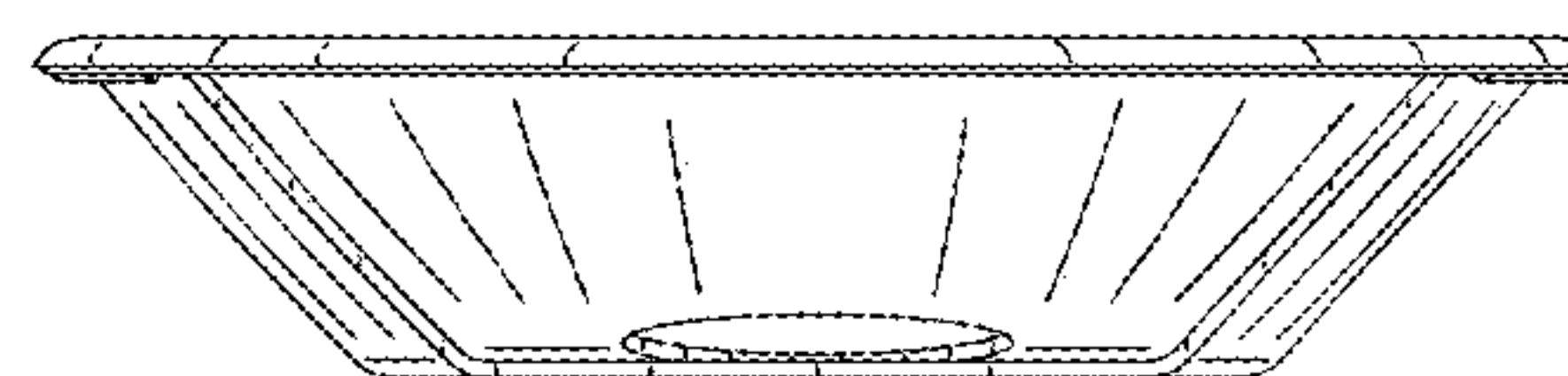

FIG. 7

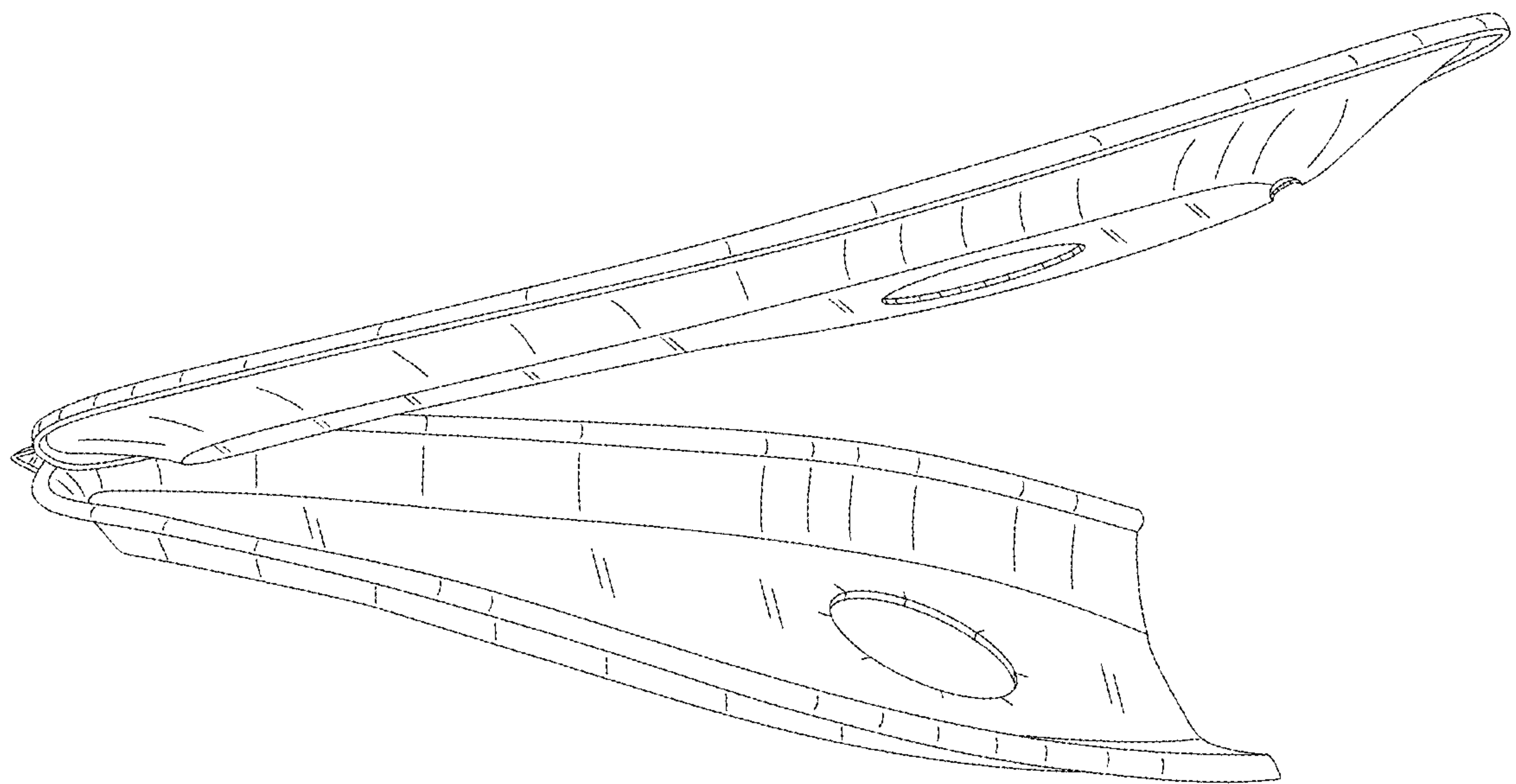

FIG. 8

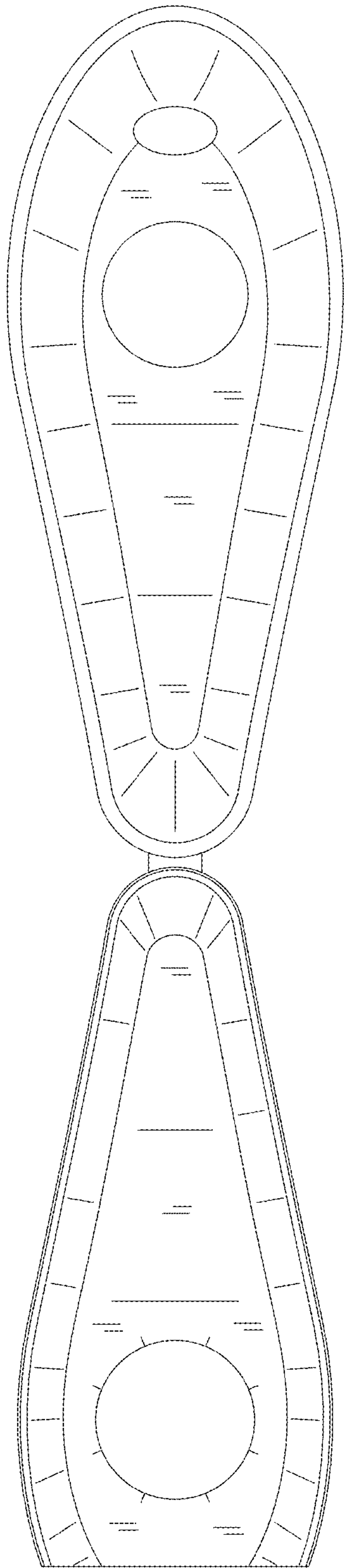

FIG. 9

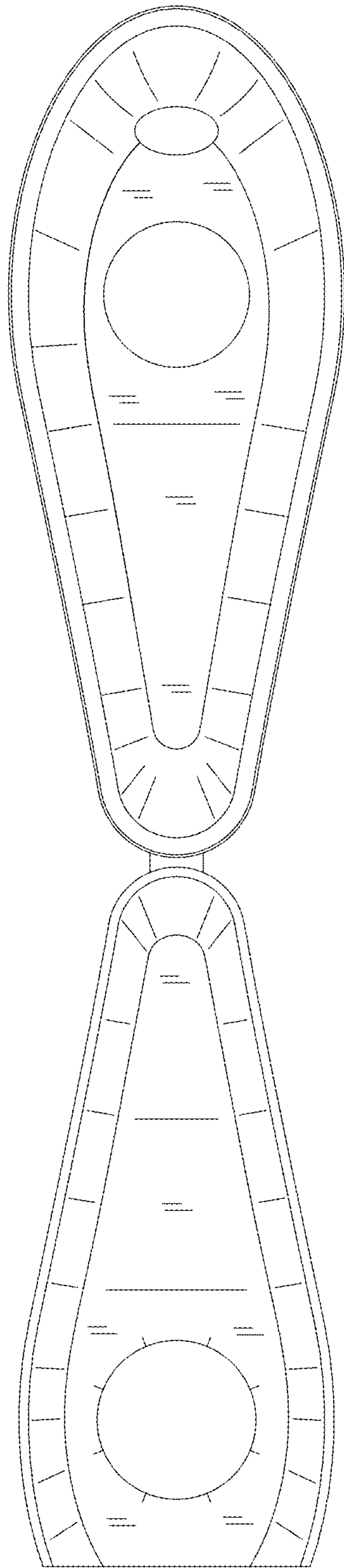

FIG. 10

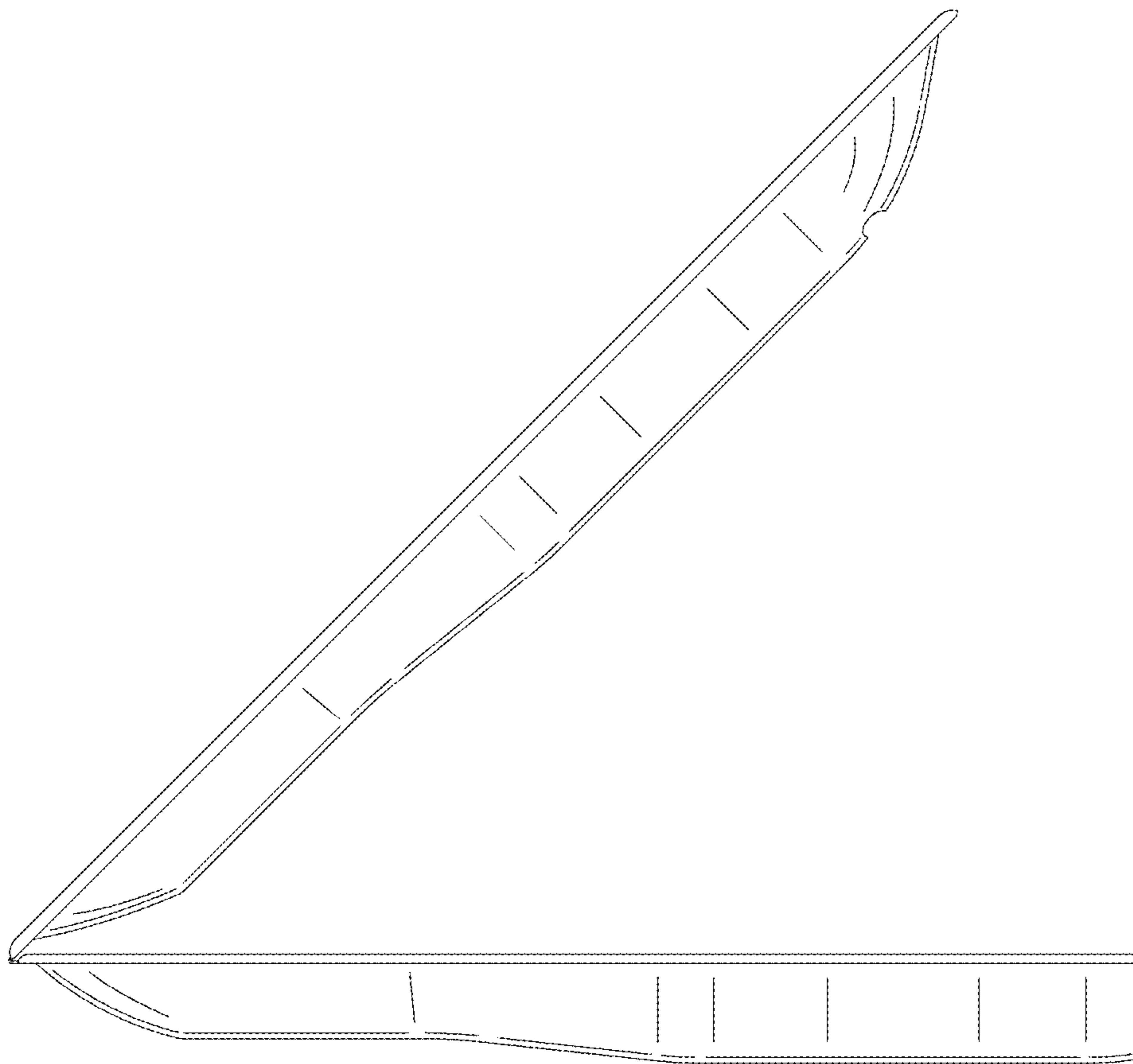

FIG. 11

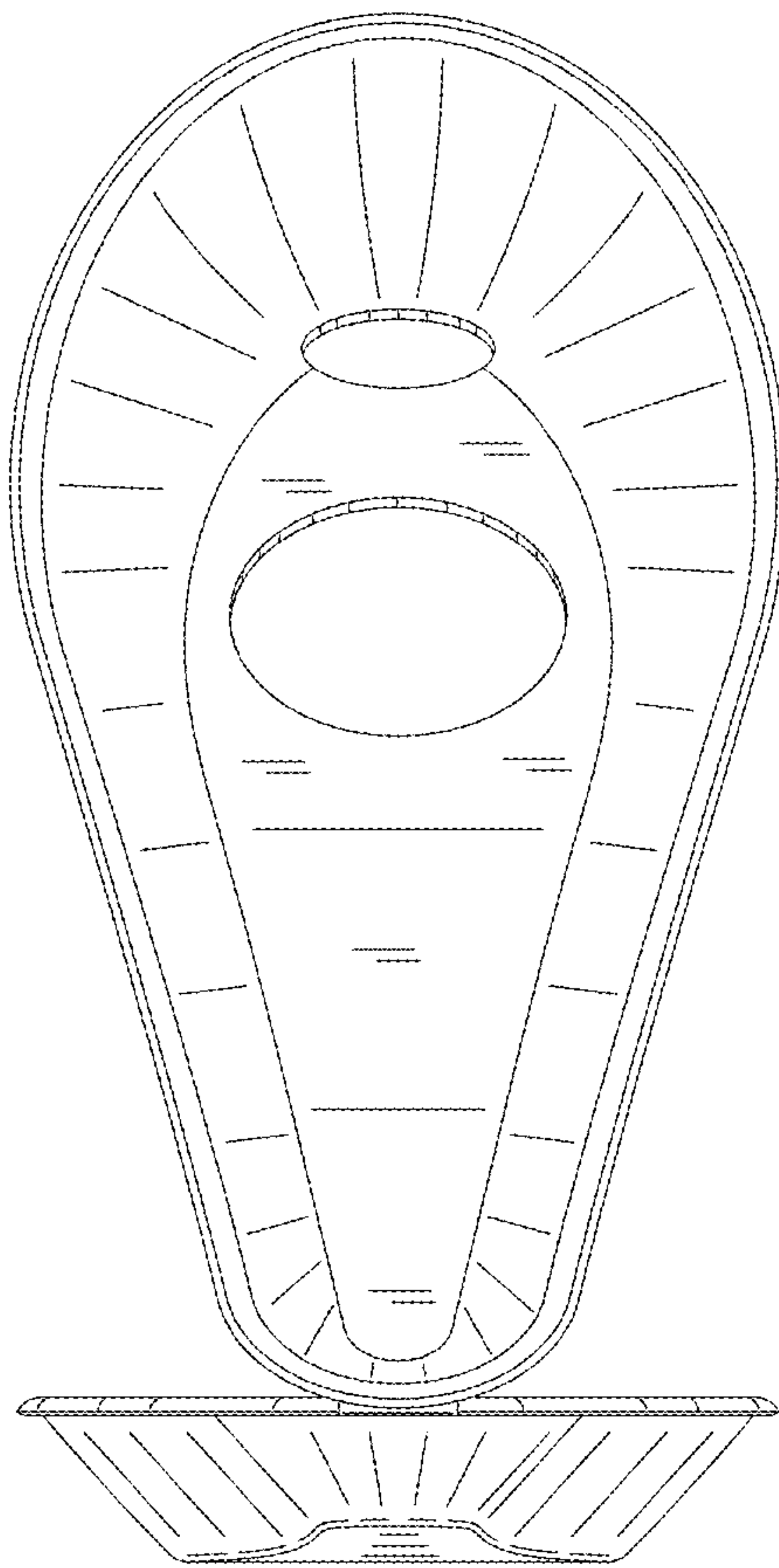

FIG. 12

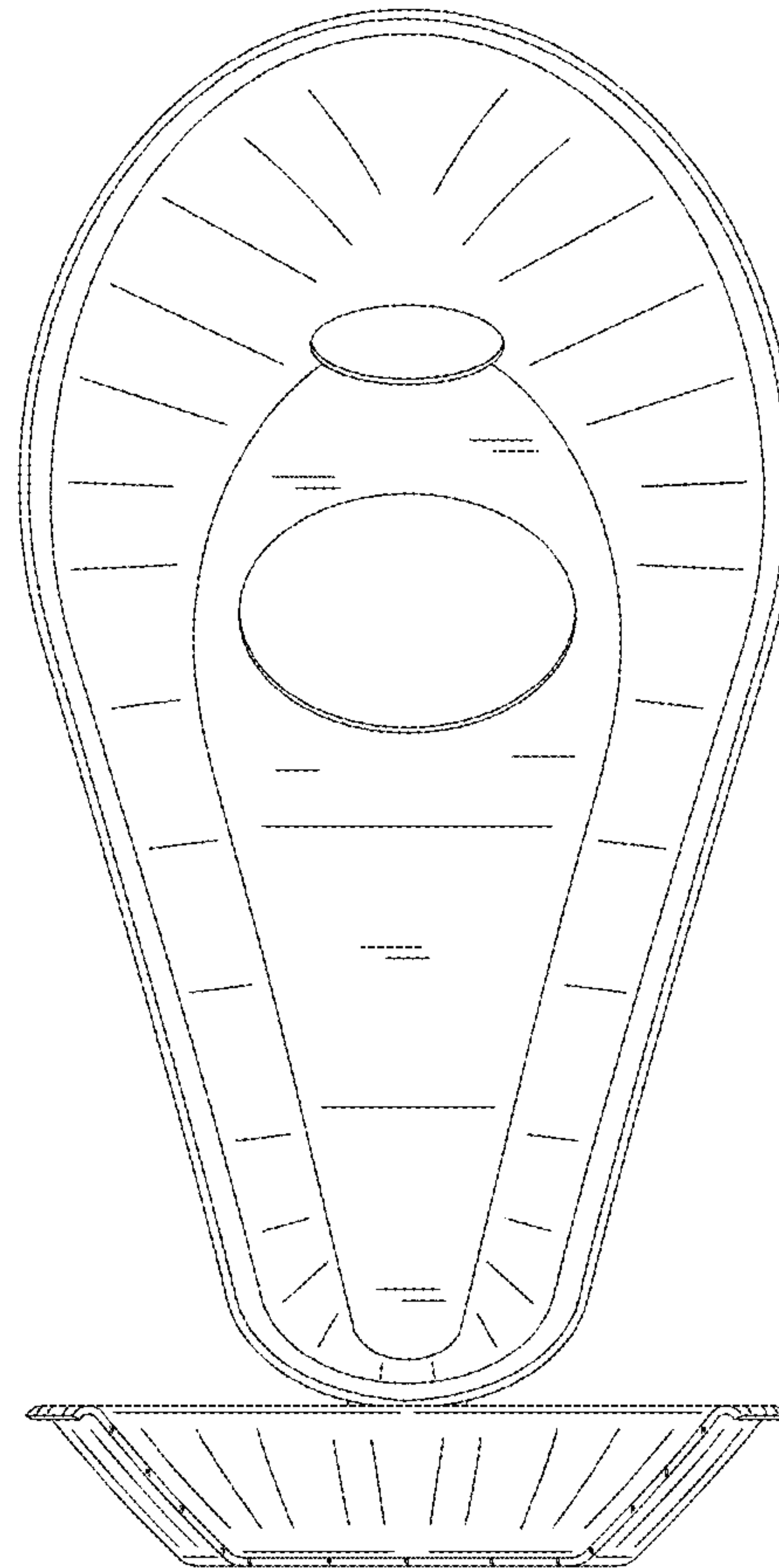

FIG. 13