



US00D983873S

(12) **United States Design Patent**  
**Borisoff et al.**

(10) **Patent No.:** **US D983,873 S**  
(45) **Date of Patent:** **\*\* Apr. 18, 2023**

(54) **SET OF STRING POSTS FOR A GUITAR**

(71) Applicant: **Hipshot Products, Inc.**, Interlaken, NY (US)

(72) Inventors: **David Joshua Borisoff**, Ovid, NY (US); **Joshua Geoffrey Borisoff**, Trumansburg, NY (US)

(73) Assignee: **Hipshot Products, Inc.**, Interlaken, NY (US)

(\*\*) Term: **15 Years**

(21) Appl. No.: **29/735,561**

(22) Filed: **May 21, 2020**

(51) **LOC (14) Cl.** ..... **17-03**

(52) **U.S. Cl.**  
USPC ..... **D17/20**

(58) **Field of Classification Search**  
USPC ..... D17/20, 14, 15, 18, 19

(Continued)

(56) **References Cited**

U.S. PATENT DOCUMENTS

D210,981 S \* 5/1968 Thompson ..... D17/20  
3,982,462 A \* 9/1976 Schaller ..... G10D 3/14  
84/306

(Continued)

*Primary Examiner* — Mark A Goodwin

(74) *Attorney, Agent, or Firm* — Lance M. Pritikin

(57) **CLAIM**

The ornamental design for a set of string posts for a guitar, as shown and described.

**DESCRIPTION**

FIG. 1 is a top view of a first embodiment of the set of string posts for a guitar, showing our new design;

FIG. 2 is a bottom view thereof;

FIG. 3 is an elevational view showing the left side view of each of the string posts of the set of string posts for guitar of FIG. 1, the right side view of each string post being identical to the left side view of the respective string post; FIG. 4 is an elevational view showing the front view of each of the string posts of the set of string posts for guitar of FIG. 1, the rear view of each string post being identical to the front view of the respective string post;

FIG. 5 is a top perspective view of the set of string posts for guitar of FIG. 1;

FIG. 6 is a bottom perspective view of the set of string posts for guitar of FIG. 1;

FIG. 7 is a further perspective view of the set of string posts for guitar of FIG. 1 as applied to respective tuning machines disassembled from a guitar headstock;

FIG. 8 is a top view of a second embodiment of the set of string posts for a guitar, showing our new design;

FIG. 9 is a bottom view thereof;

FIG. 10 is an elevational view showing the left side view of each of the string posts of the set of string posts for guitar of FIG. 8, the right side view of each string post being identical to the left side view of the respective string post;

FIG. 11 is an elevational view showing the front view of each of the string posts of the set of string posts for guitar of FIG. 8, the rear view of each string post being identical to the front view of the respective string post;

FIG. 12 is a top perspective view of the set of string posts for guitar of FIG. 8;

FIG. 13 is a bottom perspective view of the set of string posts for guitar of FIG. 8; and,

FIG. 14 is a further perspective view of the set of string posts for guitar of FIG. 8 as applied to respective tuning machines disassembled from a guitar headstock.

The broken lines are included for the purpose of illustrating environment only and form no part of the claimed design.

**1 Claim, 8 Drawing Sheets**

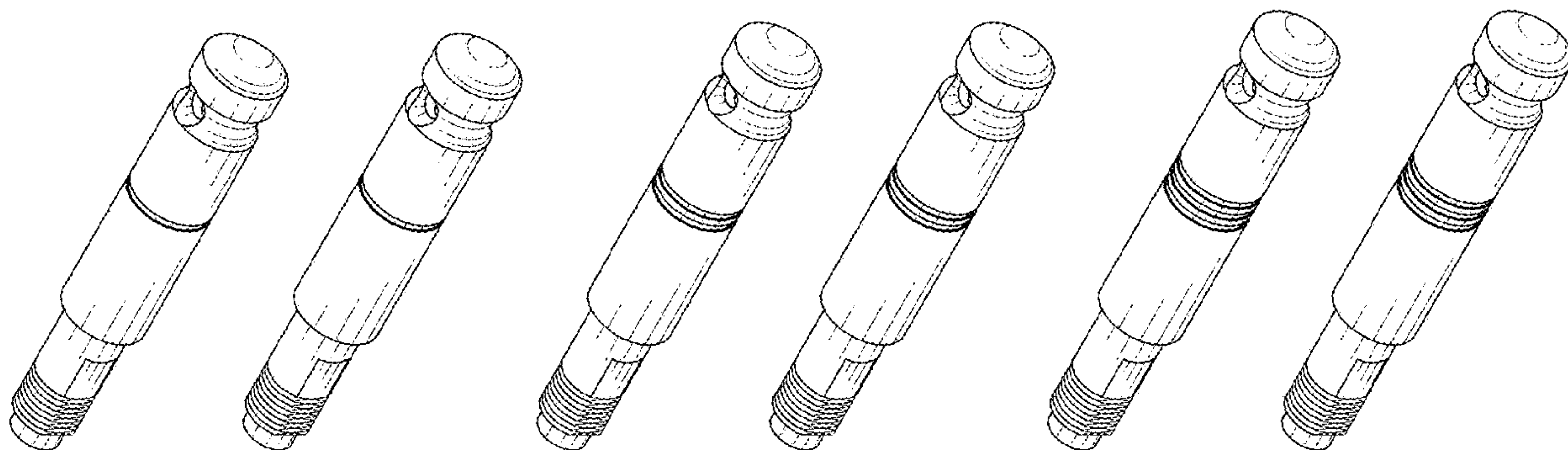

# US D983,873 S

Page 2

(58) **Field of Classification Search**

CPC ..... G10D 3/14; G10D 3/147; G10D 3/12;  
G10D 3/13; G10D 1/10; G10D 1/08

See application file for complete search history.

(56) **References Cited**

U.S. PATENT DOCUMENTS

4,014,239 A \* 3/1977 Spercel ..... G10D 3/14  
84/306  
4,026,182 A \* 5/1977 Gilbrech ..... G10D 3/14  
84/305  
D249,583 S \* 9/1978 Worthing ..... D17/20  
D256,471 S \* 8/1980 Spercel ..... D17/20  
4,515,059 A \* 5/1985 Siminoff ..... G10D 3/14  
984/119  
D280,523 S \* 9/1985 Smith ..... D17/20  
D280,524 S \* 9/1985 Smith ..... D17/20  
D300,537 S \* 4/1989 Powers ..... D17/20  
D311,414 S \* 10/1990 Smith ..... D17/20  
4,970,930 A \* 11/1990 Secord ..... G10D 3/14  
84/304  
5,097,736 A \* 3/1992 Turner ..... G10D 3/14  
24/71.1  
5,381,715 A \* 1/1995 Spercel ..... G10D 3/14  
84/304  
D386,778 S \* 11/1997 Goto ..... D17/20

D388,817 S \* 1/1998 Kang ..... D17/20  
D389,508 S \* 1/1998 Kang ..... D17/20  
5,728,955 A \* 3/1998 Sperzel ..... G10D 3/14  
84/306  
5,767,427 A \* 6/1998 Corso ..... G10D 3/14  
84/306  
6,023,014 A \* 2/2000 Sperzel ..... G10D 3/14  
84/312 R  
D421,766 S \* 3/2000 Deyoe ..... D17/20  
6,365,809 B1 \* 4/2002 Steinberger ..... G10D 3/14  
84/304  
6,608,248 B1 \* 8/2003 Sperzel ..... G10D 3/14  
84/304  
D483,055 S \* 12/2003 Vogel ..... D17/20  
D650,831 S \* 12/2011 Chan ..... D17/20  
D673,209 S \* 12/2012 Reboul ..... D17/20  
D728,674 S \* 5/2015 Chang ..... D17/20  
D775,269 S \* 12/2016 Stanley ..... D17/20  
10,269,332 B1 \* 4/2019 Rickard ..... G10D 3/14  
11,238,837 B2 \* 2/2022 Pirquet ..... G10D 3/14  
2002/0026864 A1 \* 3/2002 Gotoh ..... G10D 3/14  
84/304  
2006/0016317 A1 \* 1/2006 Wilkinson ..... G10D 3/14  
84/304  
2017/0193973 A1 \* 7/2017 Middleton ..... F16H 1/16  
2020/0202820 A1 \* 6/2020 Pirquet ..... G10D 3/14  
2022/0020343 A1 \* 1/2022 Dunwoodie ..... G10D 3/14  
2022/0293070 A1 \* 9/2022 Cardozo ..... G10D 1/05

\* cited by examiner

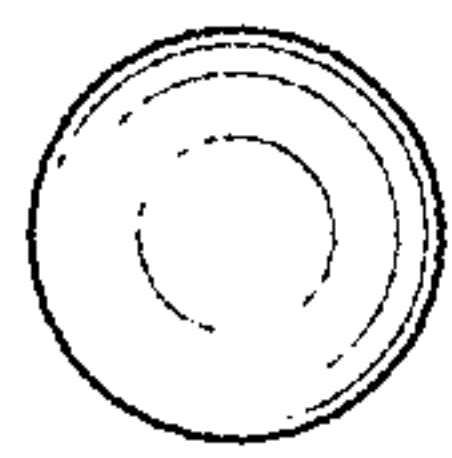
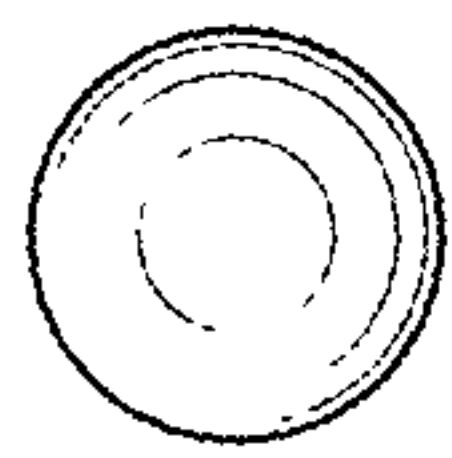
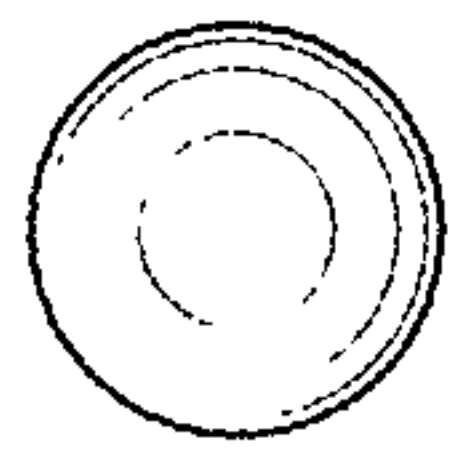
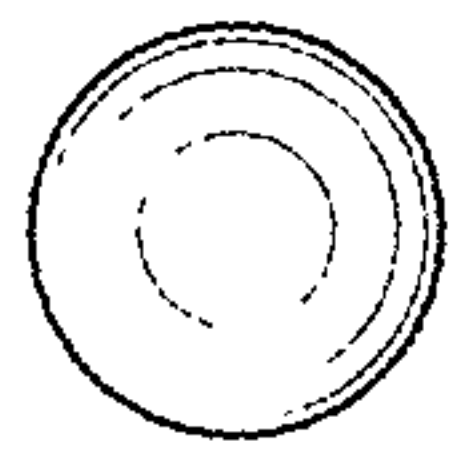
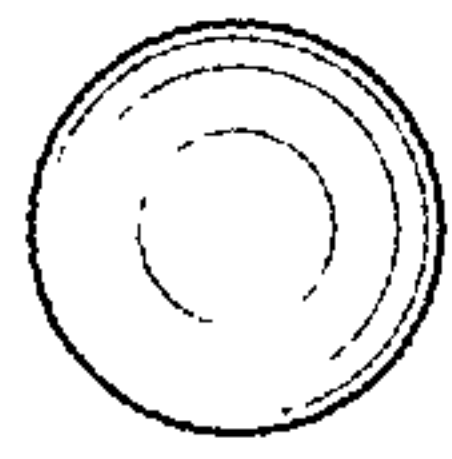
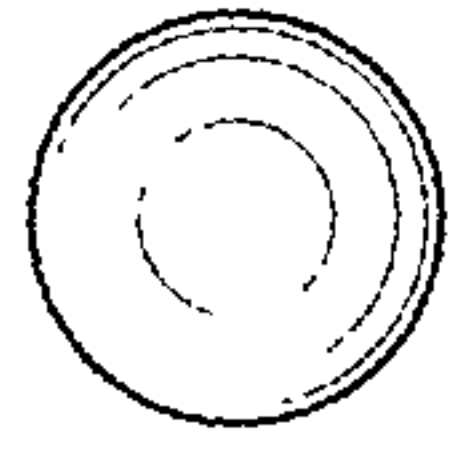

FIG. 1

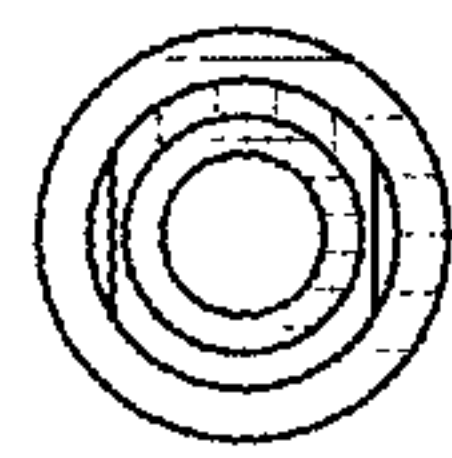
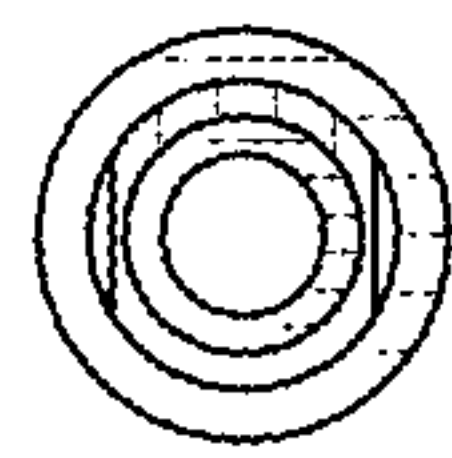
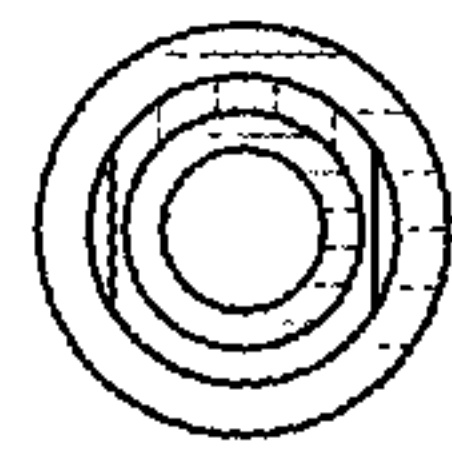
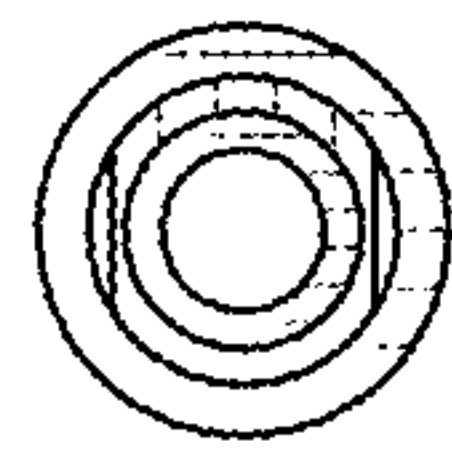
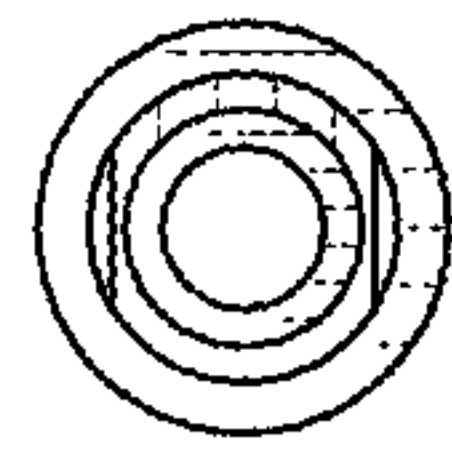
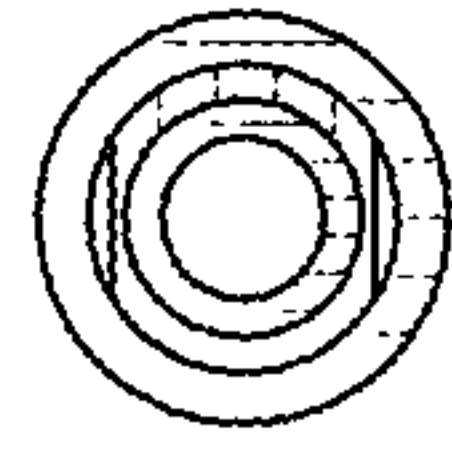

FIG. 2



FIG. 3

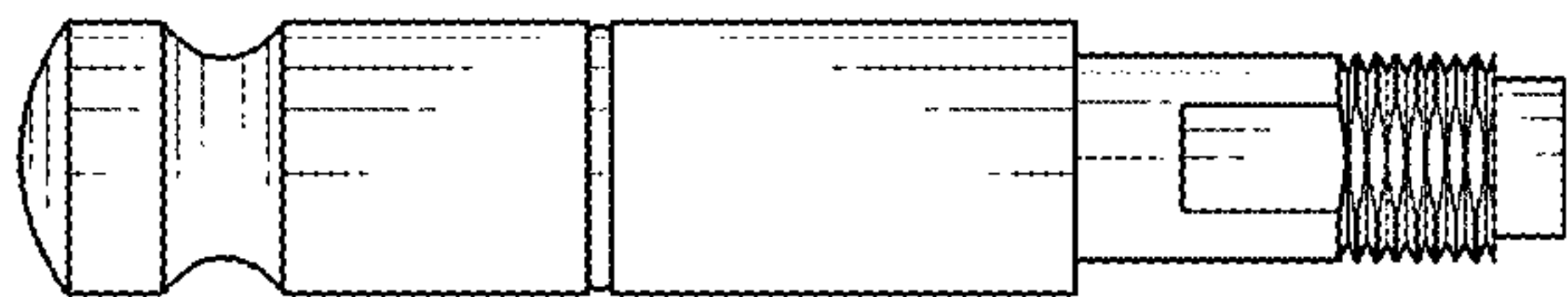
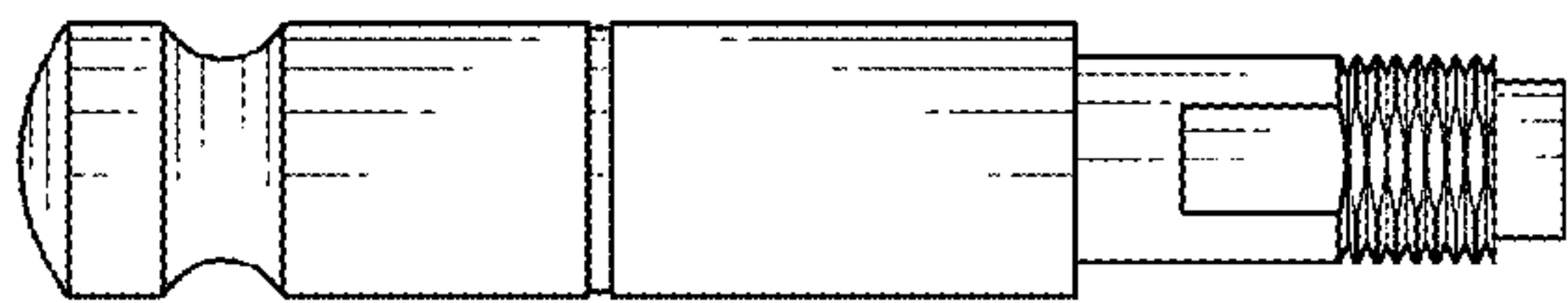
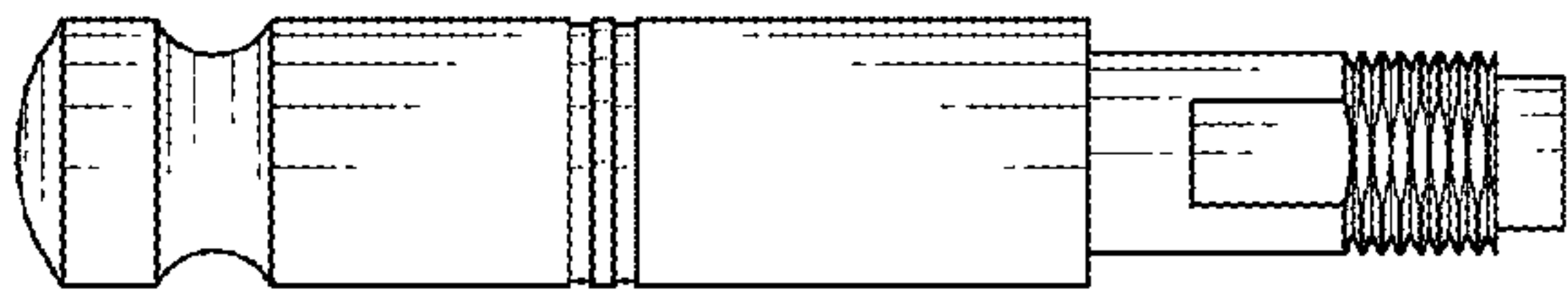
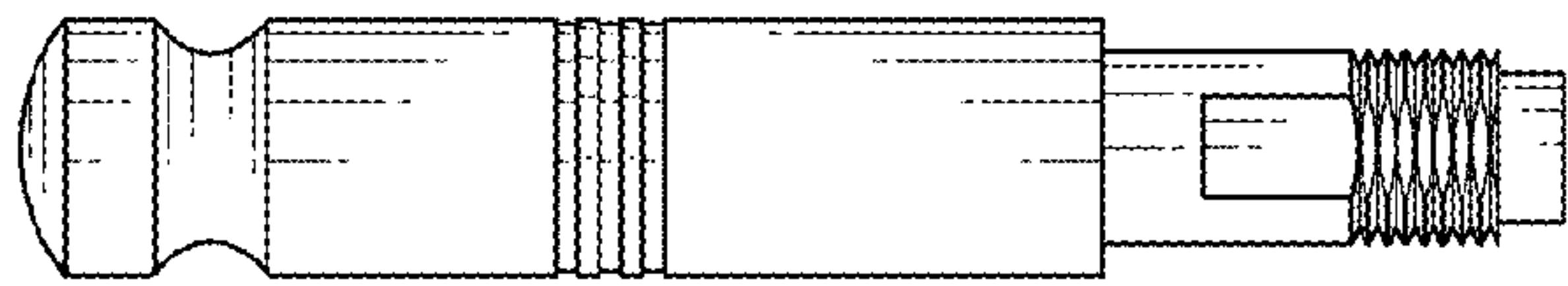
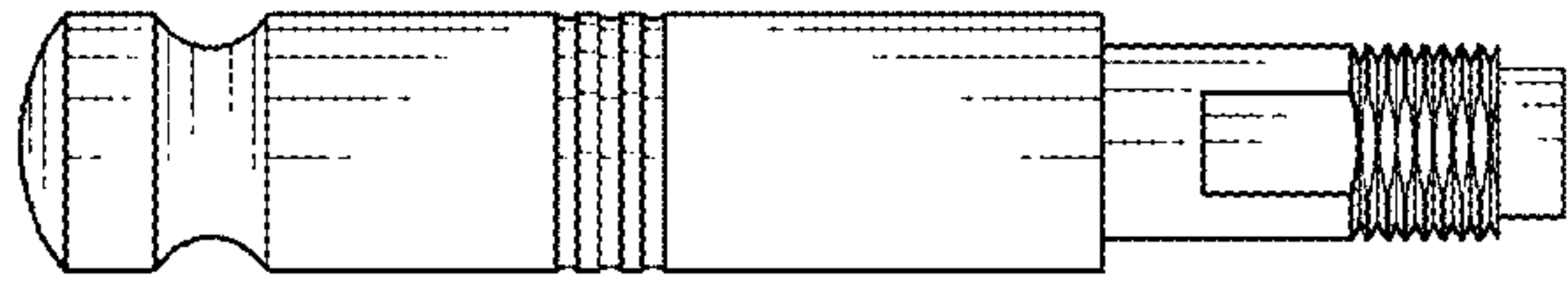
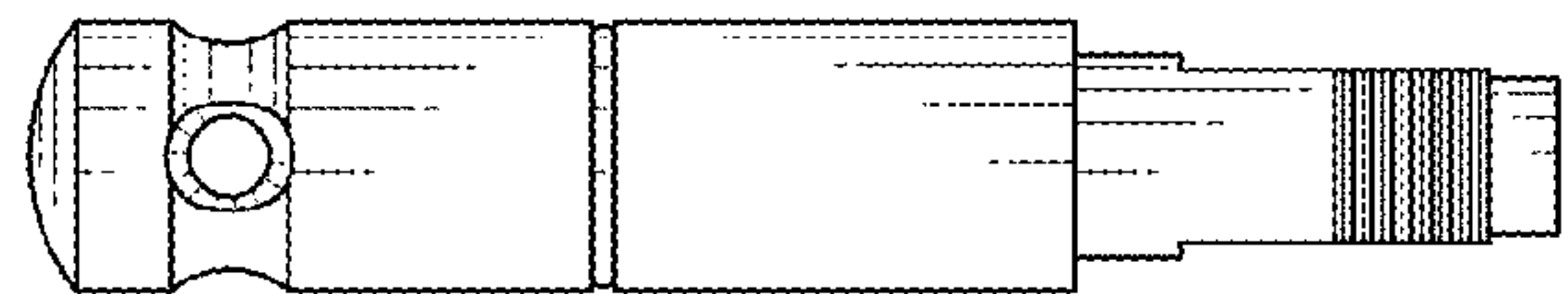
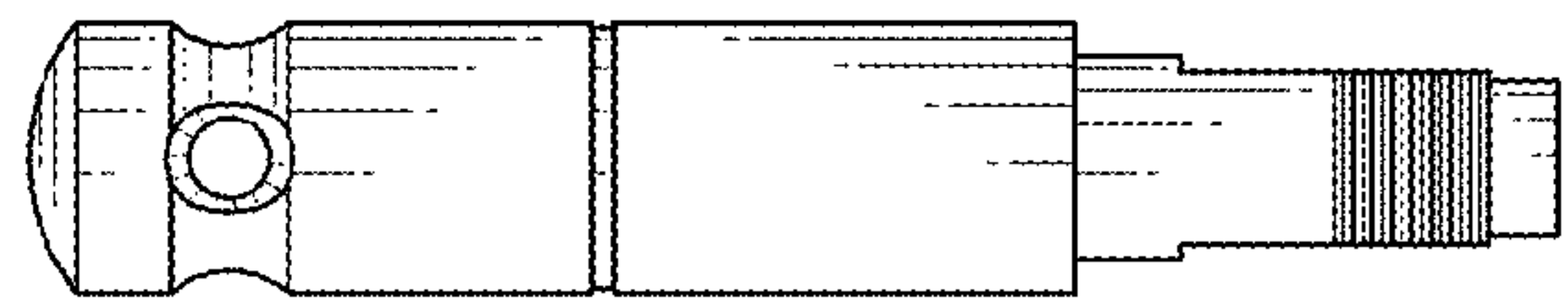
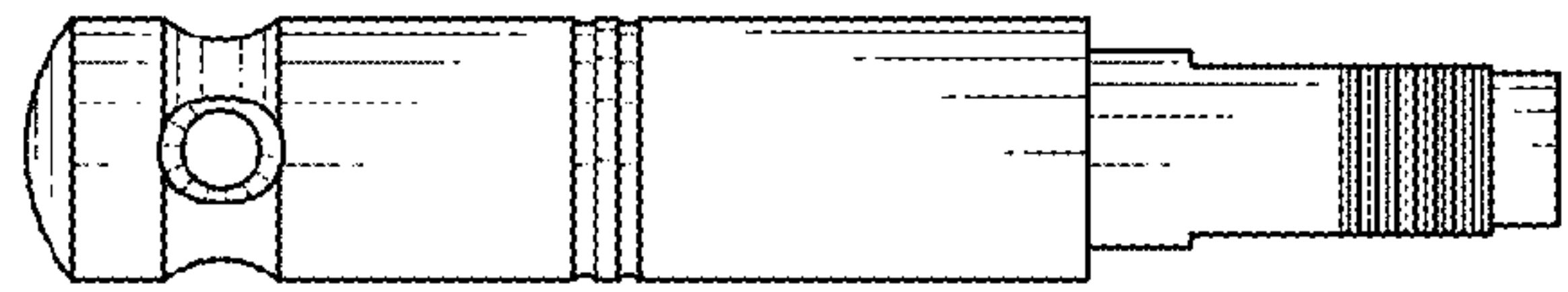
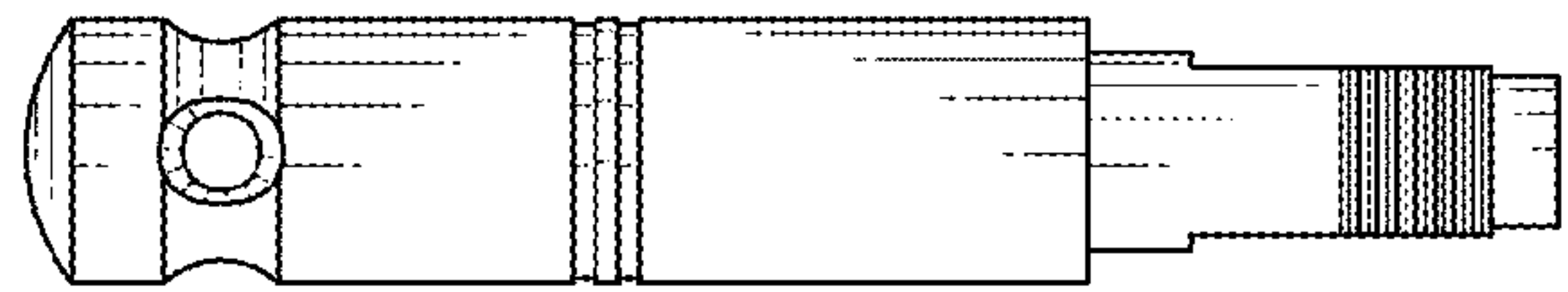
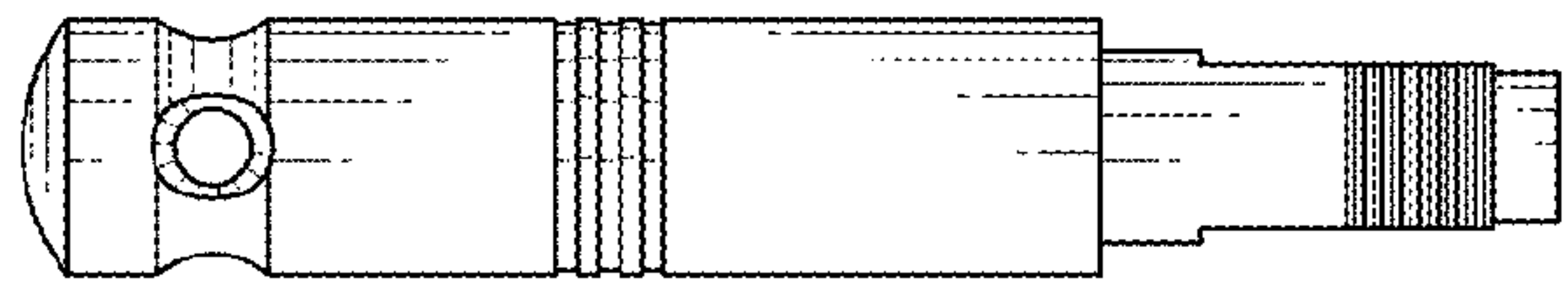
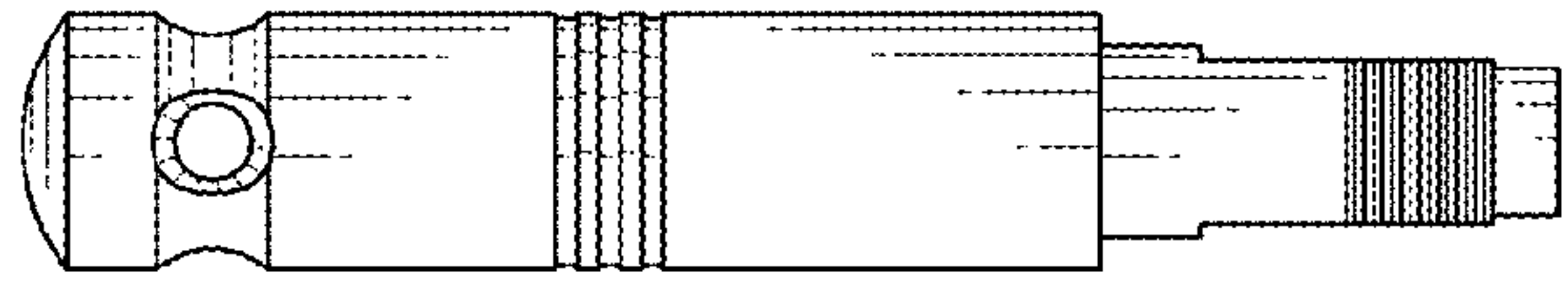
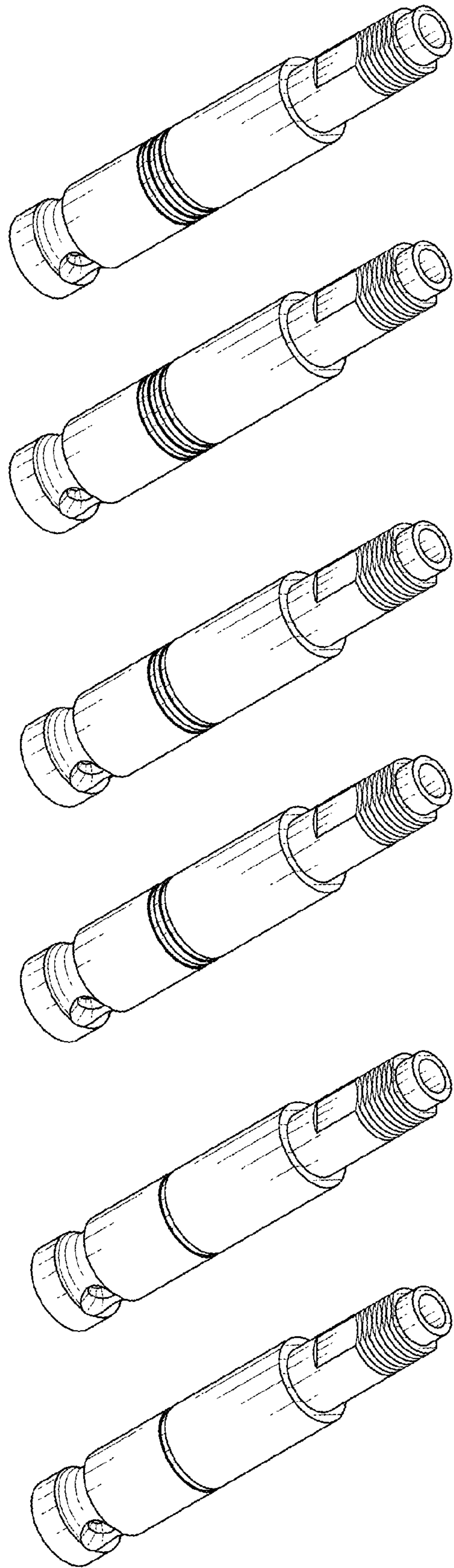
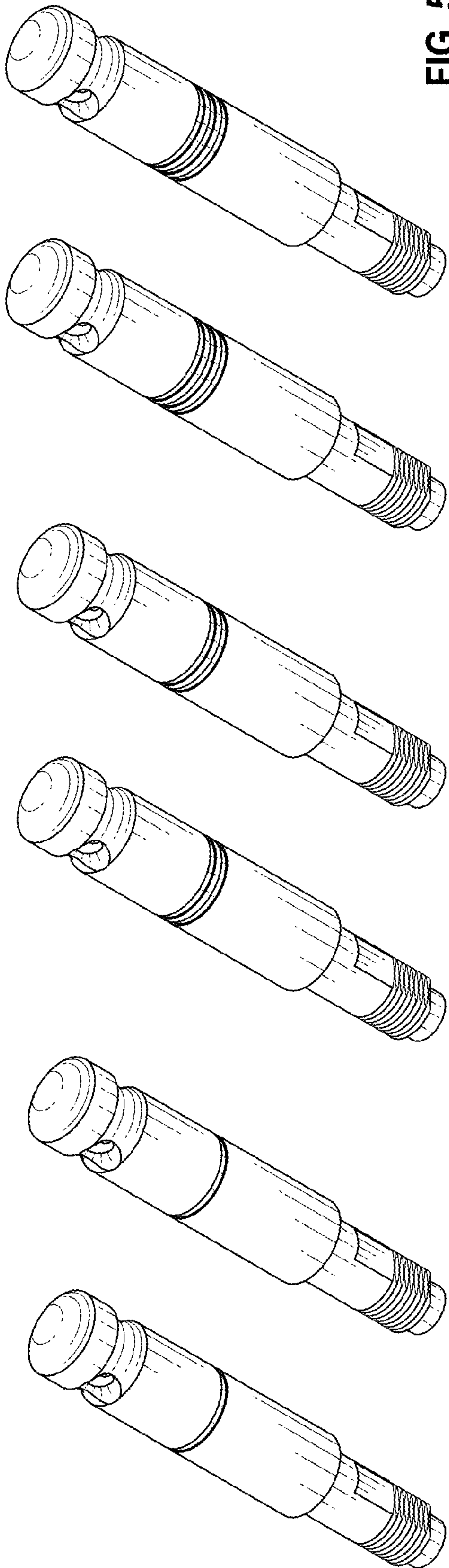

FIG. 4





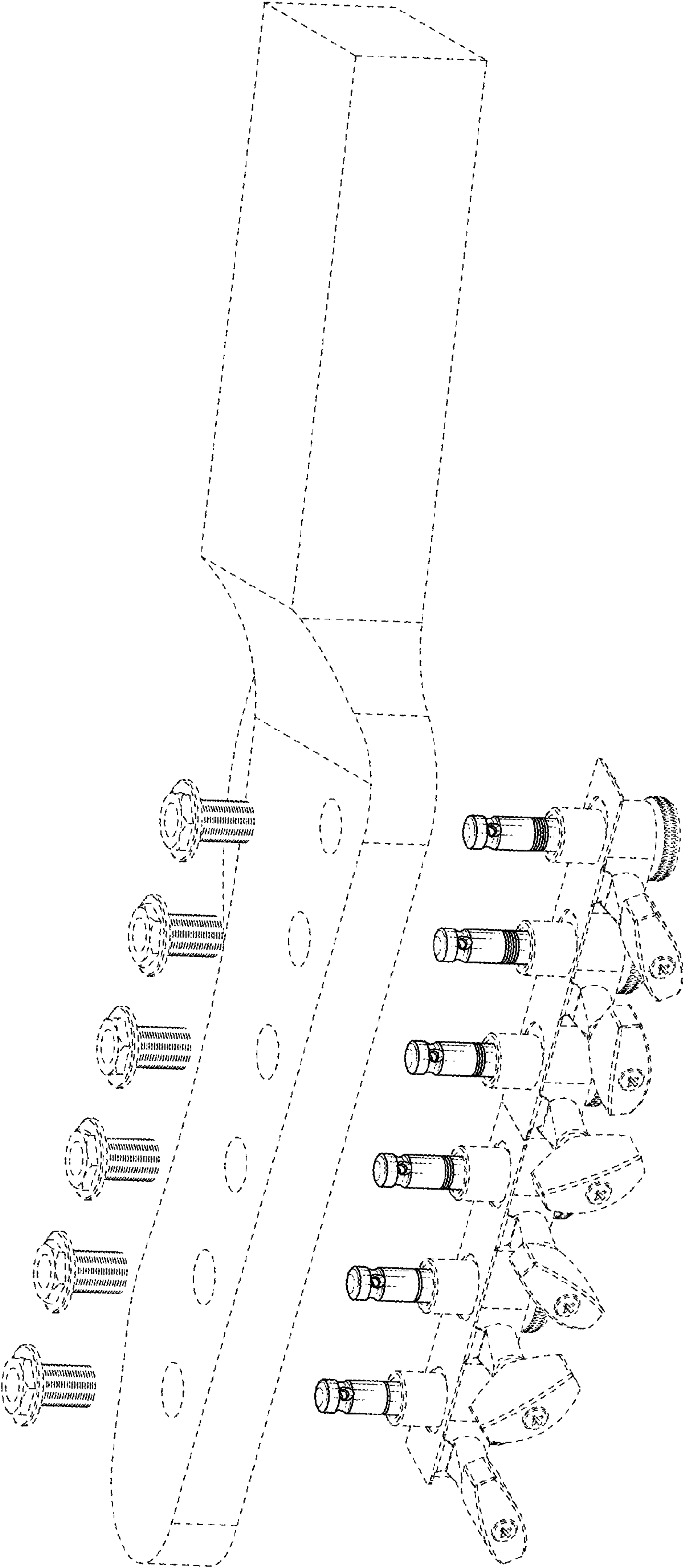

FIG. 7

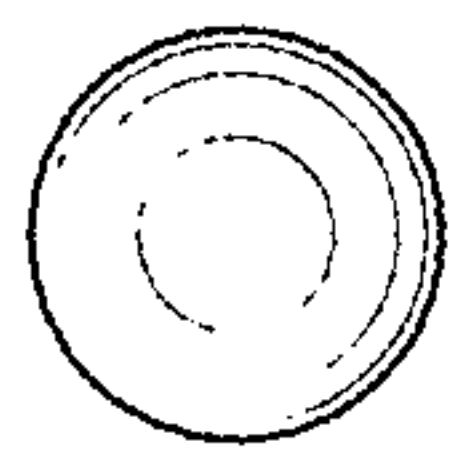
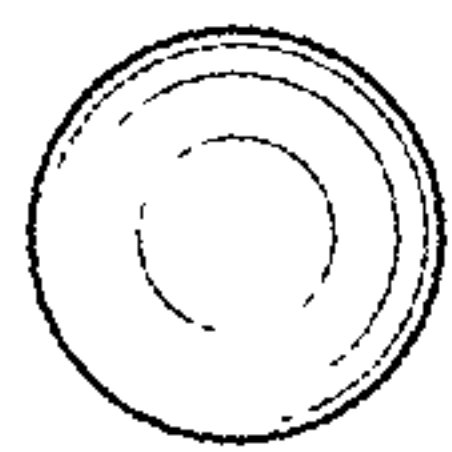
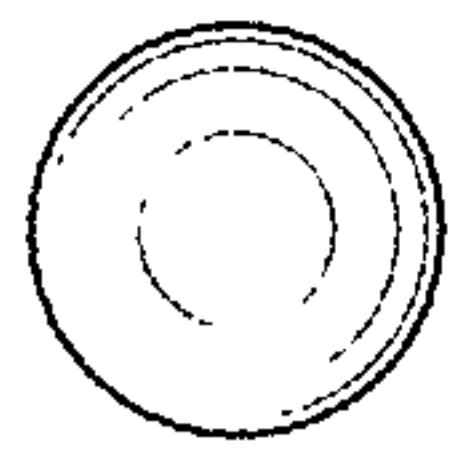
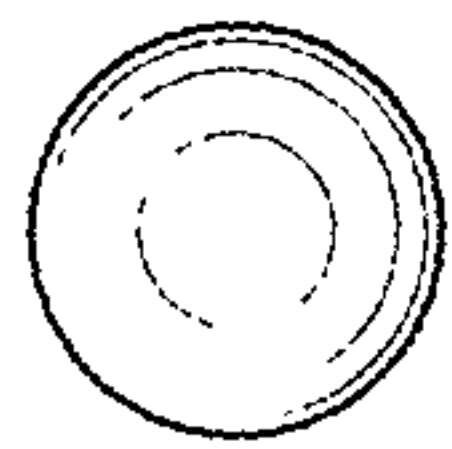
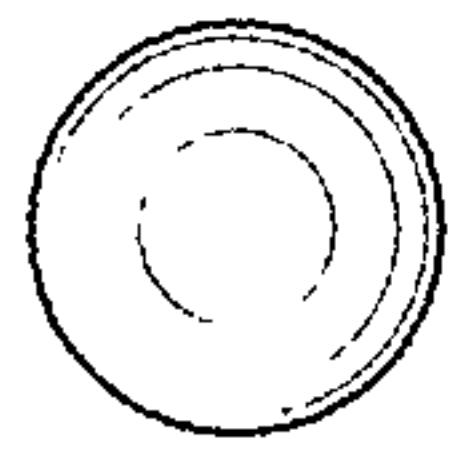
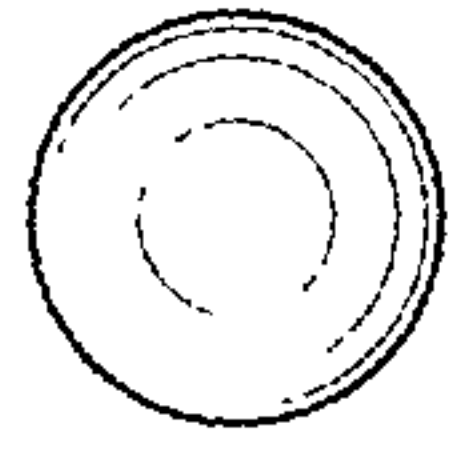

FIG. 8

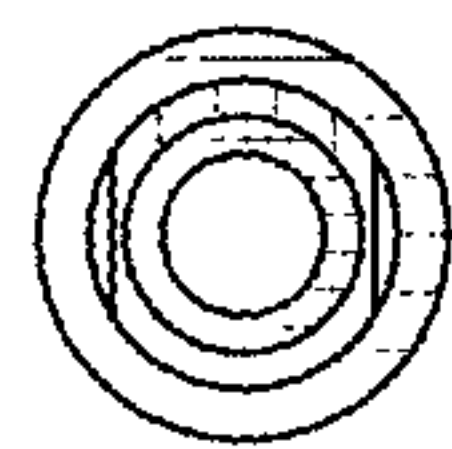
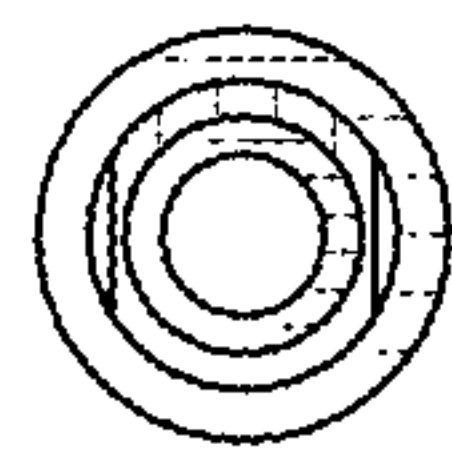
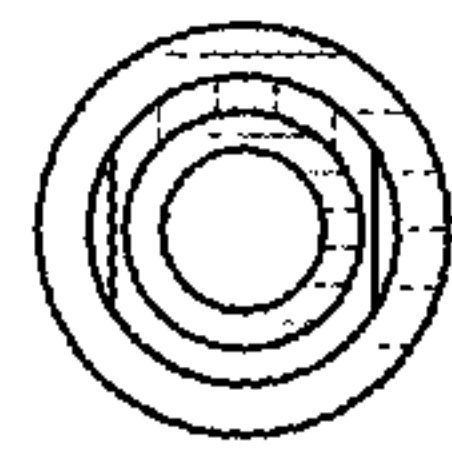
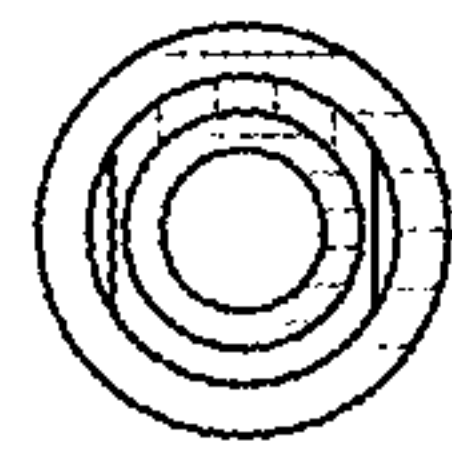
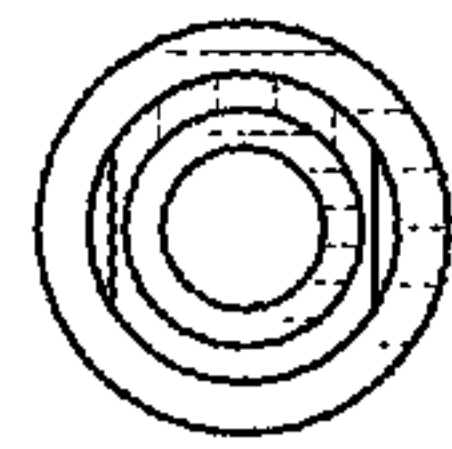
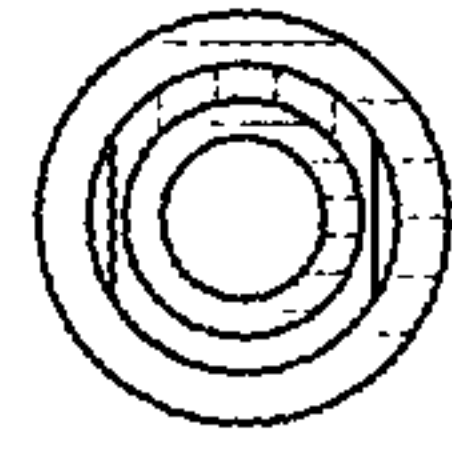

FIG. 9



FIG. 10

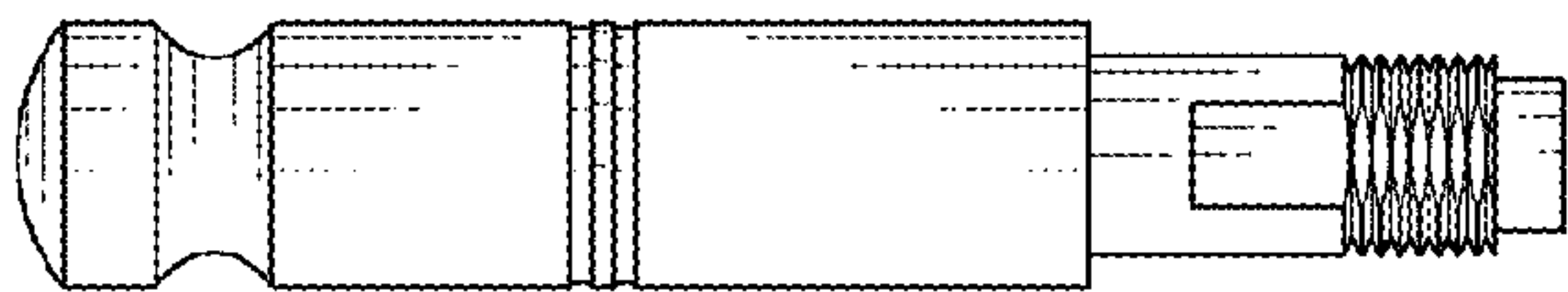
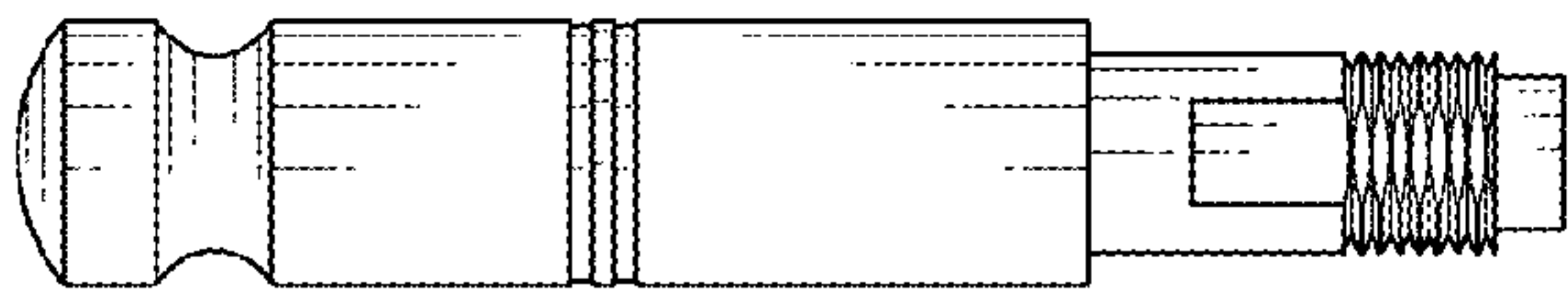
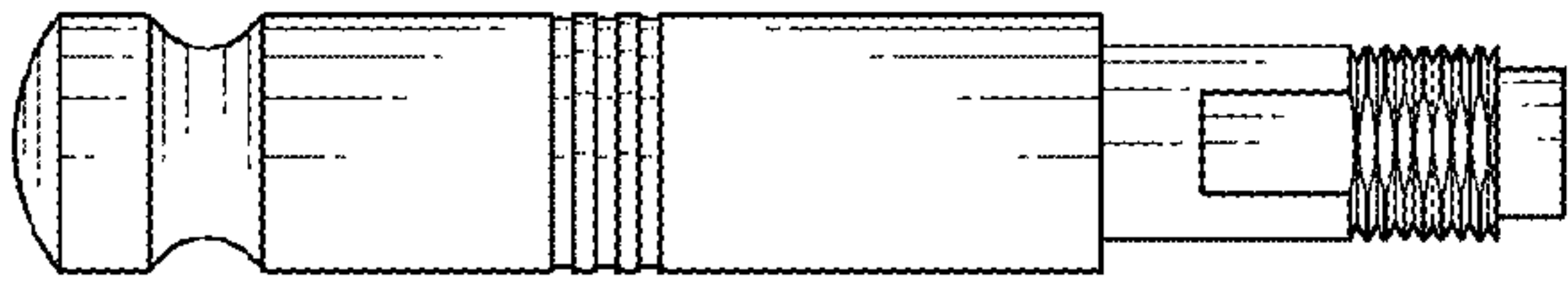
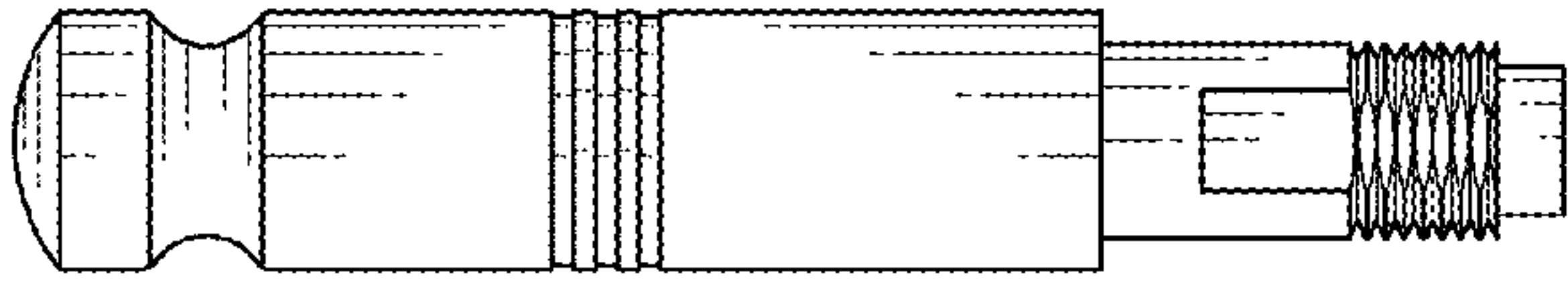
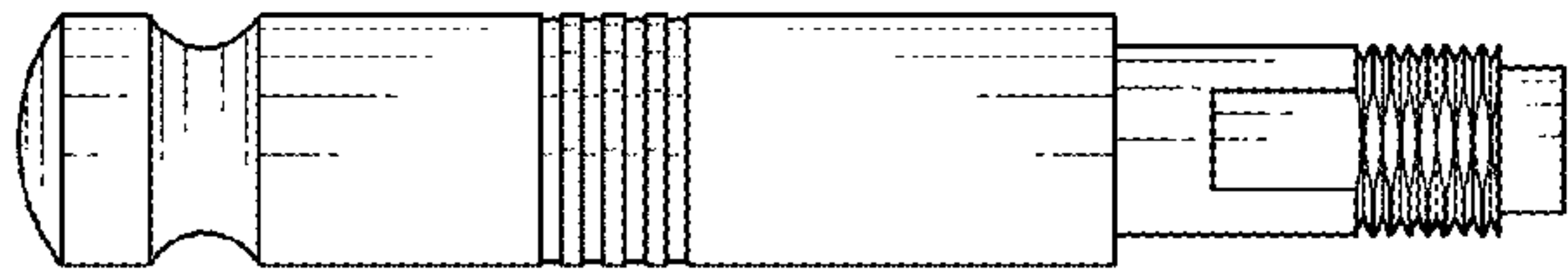
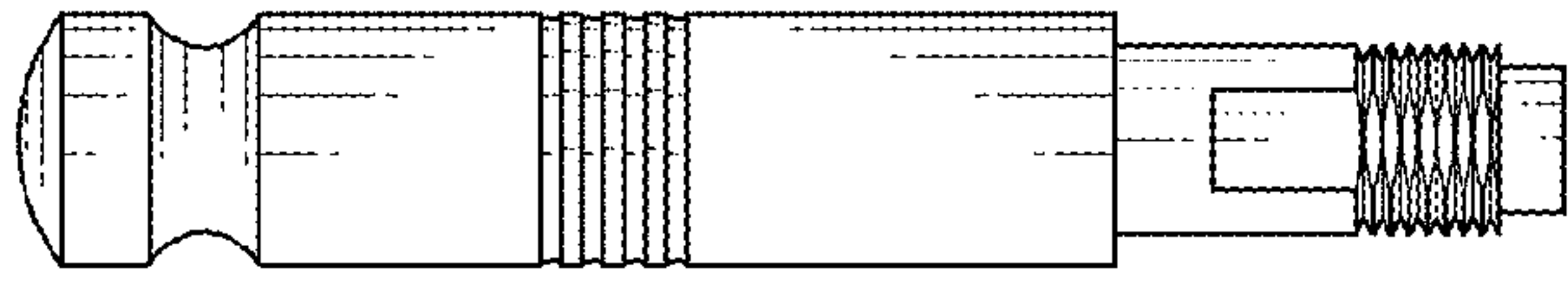
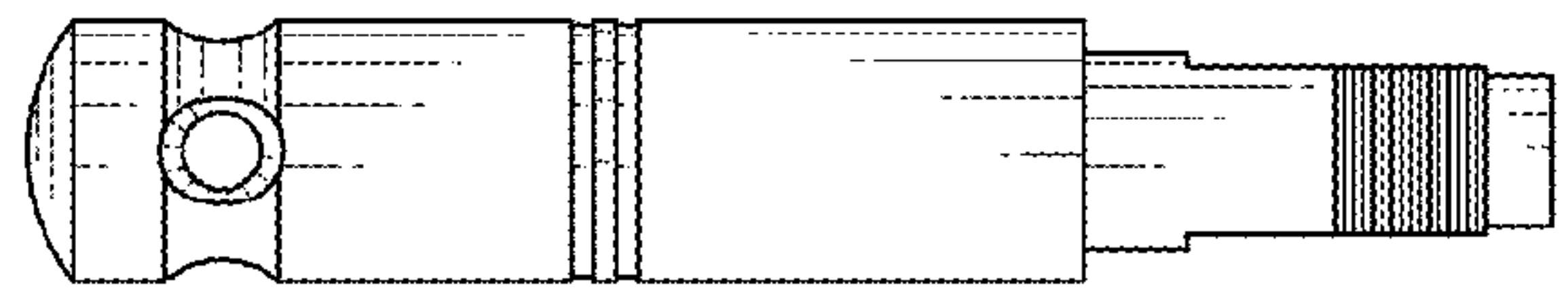
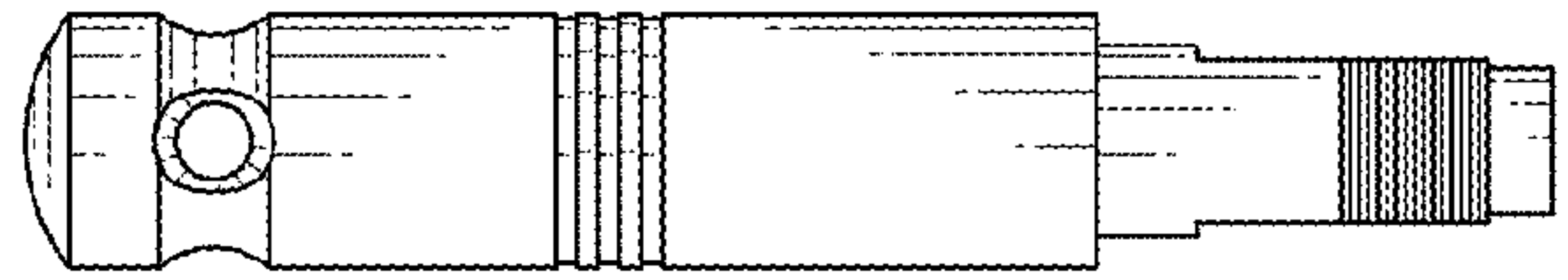
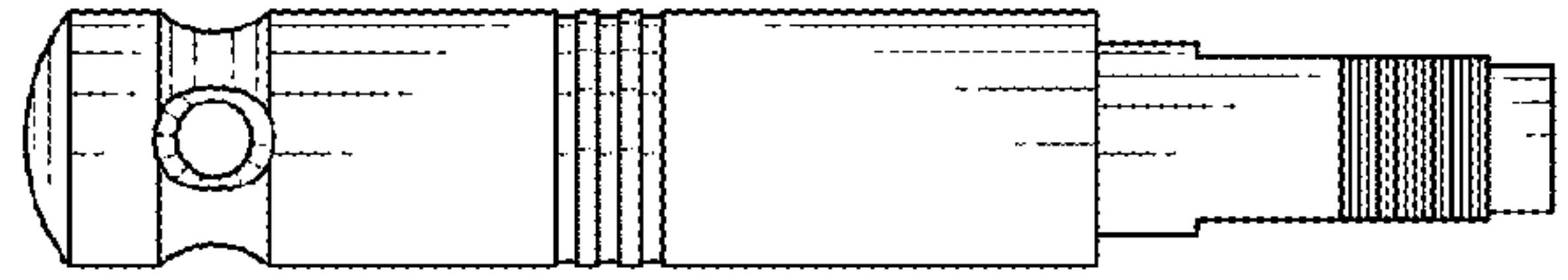
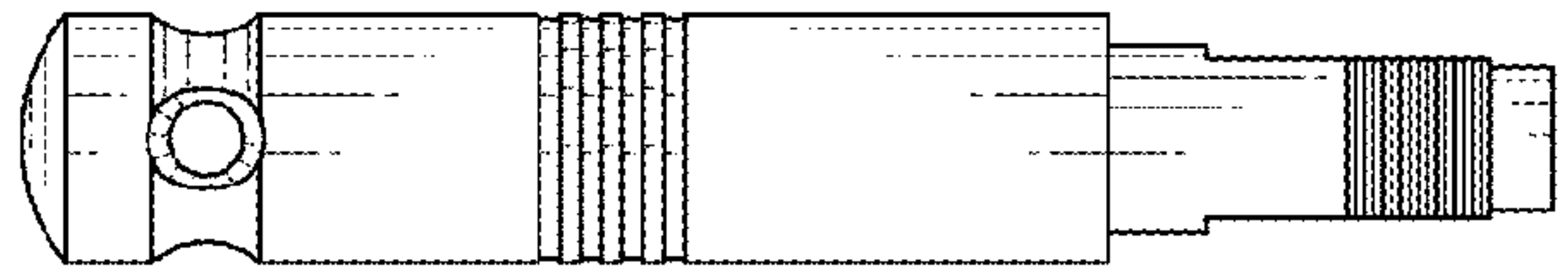
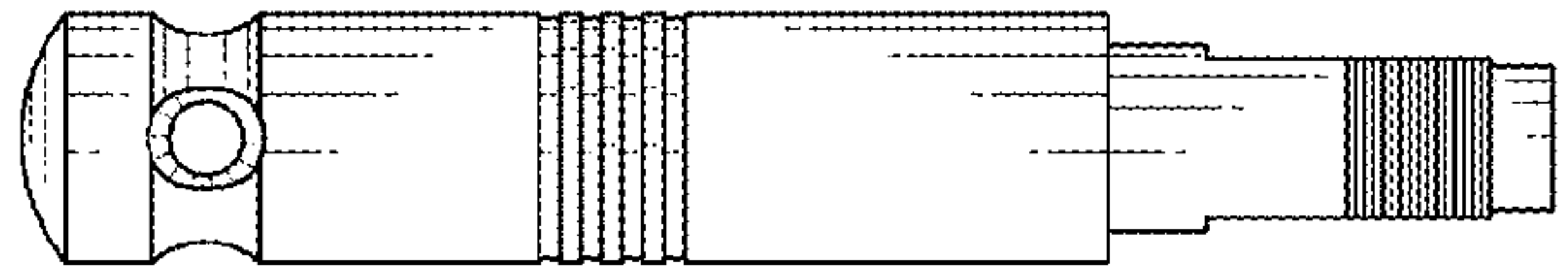

FIG. 11





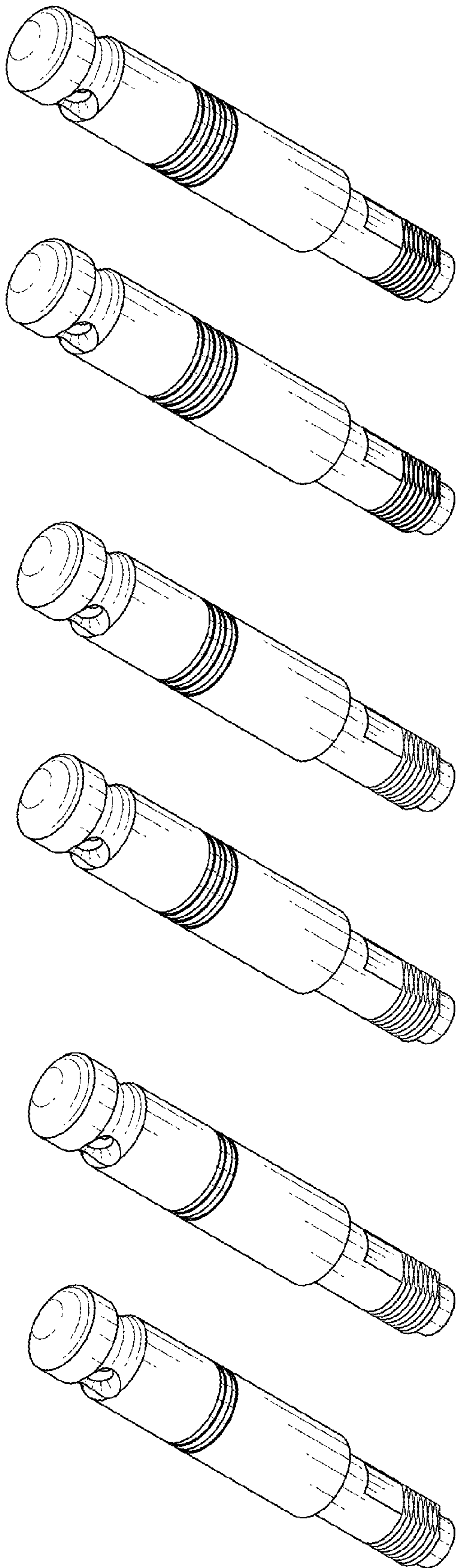

FIG. 12

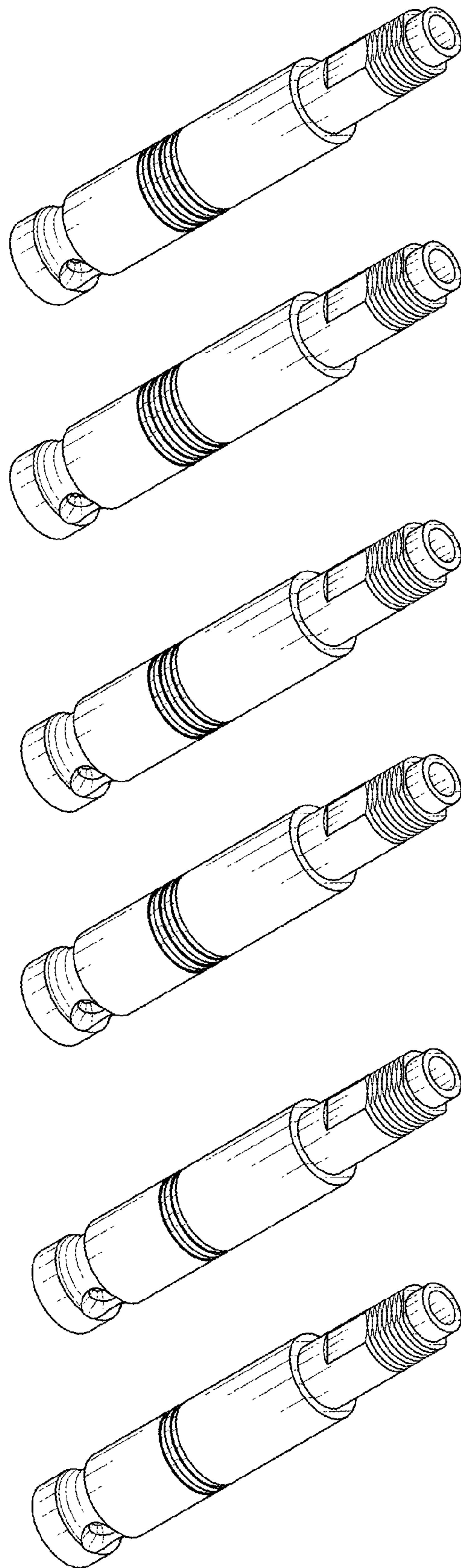

FIG. 13

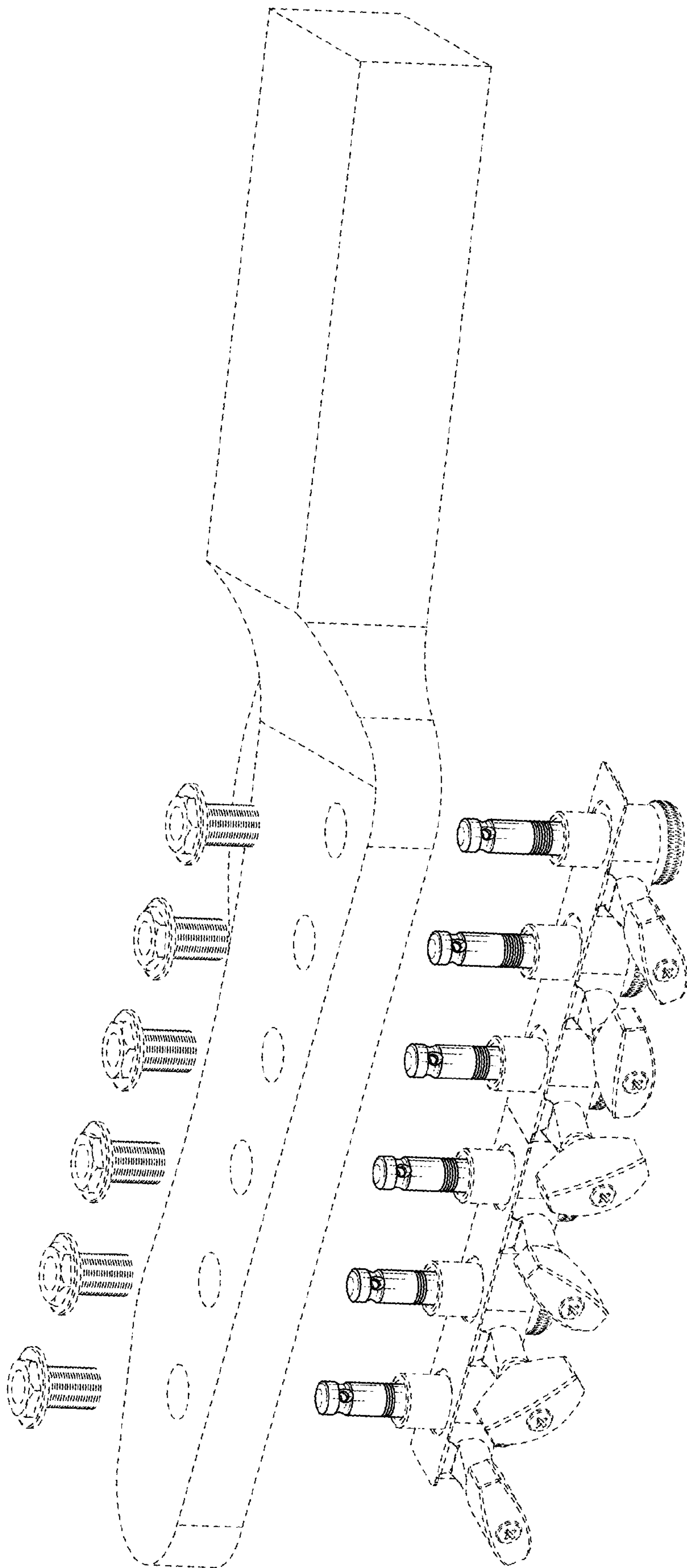

FIG. 14