



US00D983867S

(12) **United States Design Patent**
Cowart et al.

(10) **Patent No.:** **US D983,867 S**
(45) **Date of Patent:** **** Apr. 18, 2023**

- (54) **EYE SHIELD**
- (71) Applicant: **DeRoyal Industries, Inc.**, Powell, TN (US)
- (72) Inventors: **Walter C. Cowart**, Blaine, TN (US); **Ethan Edward Valentine**, Knoxville, TN (US); **Nicholas John Poker**, Knoxville, TN (US); **Phillip David Peery**, Sweetwater, TN (US)
- (73) Assignee: **DeRoyal Industries, Inc.**, Powell, TN (US)
- (**) Term: **15 Years**
- (21) Appl. No.: **29/808,176**
- (22) Filed: **Sep. 17, 2021**
- (51) **LOC (14) Cl.** **16-06**
- (52) **U.S. Cl.**
USPC **D16/314**
- (58) **Field of Classification Search**
USPC D16/300, 314, 315, 325, 341;
D24/110.1, 110.2, 110.3; D29/102, 104,
D29/105, 107, 108
CPC G02C 1/00; G02C 1/04; G02C 2200/12;
G02C 1/08
See application file for complete search history.

- D347,017 S * 5/1994 Bolle D16/314
- 5,375,702 A 12/1994 Fiallo
- D354,068 S * 1/1995 Canavan D16/313
- 5,765,223 A * 6/1998 McCausland A41D 13/1184
2/427
- D428,620 S * 7/2000 Maturaporn D16/329
(Continued)

FOREIGN PATENT DOCUMENTS

- CN 305973984 * 8/2020
- GB 1210962 A 11/1970
(Continued)

OTHER PUBLICATIONS

Amazon Meigix Safety Glasses, earliest pictured Sep. 27, 2020, [online], [site visited Dec. 22, 2022]. Available via Internet, <URL:https://www.amazon.com/dp/B08F7HFN77?_encoding=UTF8&ref_=cm_sw_r_cp_ud_dp_0ZY2XRXS7ZBCH7VVHV7A&th=1> (Year: 2020).*

(Continued)

Primary Examiner — Sanjeev Paul
Assistant Examiner — Breana Copeland
(74) *Attorney, Agent, or Firm* — Luedeka Neely Group, PC

(57) **CLAIM**

The ornamental design for an eye shield, as shown and described.

DESCRIPTION

FIG. 1 is a perspective view of an eye shield of our new design.
FIG. 2 is a frontal view thereof.
FIG. 3 is a rear view thereof.
FIG. 4 is a top view thereof.
FIG. 5 is a bottom view thereof.
FIG. 6 is a left side view thereof; and,
FIG. 7 is a right side view thereof.

1 Claim, 5 Drawing Sheets

(56) **References Cited**

U.S. PATENT DOCUMENTS

- 653,086 A 7/1900 Houts
- 1,380,561 A 6/1921 Kaufmann
- 1,860,324 A 5/1932 Einson
- 2,006,445 A 7/1935 Davidson
- 2,030,996 A 2/1936 Lustig
- 2,031,575 A 2/1936 Roe
- 2,137,906 A 11/1938 Cummings
- 2,517,030 A 8/1950 Ringler
- 4,822,158 A 4/1989 Porsche
- 4,951,322 A * 8/1990 Lin G02C 5/02
351/44

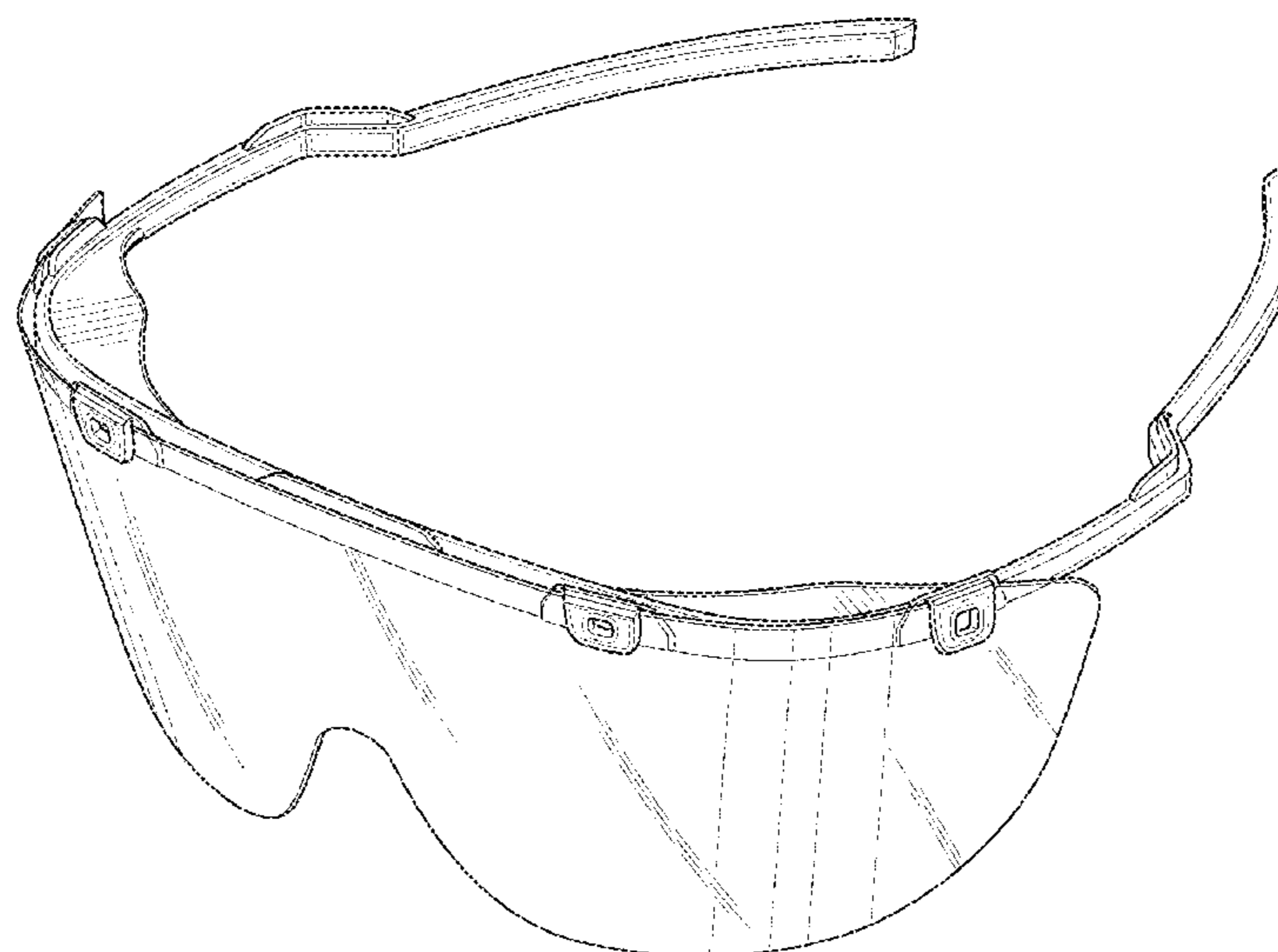

(56)

References Cited

U.S. PATENT DOCUMENTS

6,533,412	B1	3/2003	Wang et al.	
6,964,067	B1	11/2005	Hartman	
RE41,097	E *	2/2010	Bruck	D16/311
7,661,815	B2	2/2010	Lipawsky	
8,992,007	B2	3/2015	Li	
10,517,763	B2	12/2019	Quinn et al.	
10,543,955	B1	1/2020	Turturro et al.	
D880,779	S *	4/2020	Sato	D29/110
10,702,345	B2	7/2020	Saito et al.	
2008/0087556	A1	4/2008	Henke et al.	
2009/0188015	A1	7/2009	Grad et al.	
2009/0314661	A1	12/2009	Fisher et al.	
2018/0228652	A1	8/2018	Ohura	
2022/0113560	A1*	4/2022	Cowart	G02C 9/04
2022/0133541	A1*	5/2022	Cowart	A61F 9/025 2/450

FOREIGN PATENT DOCUMENTS

GB	9000358684-0001	*	6/2005
GB	2442755 A		4/2008
GB	6196588	*	3/2022
GB	6196589	*	3/2022

OTHER PUBLICATIONS

Mountainside Medical Equipment Protective Barrier Safety Glasses, earliest pictured Apr. 9, 2018, [online], [site visited Dec. 22, 2022]. Available via Internet, <URL:https://www.mountainside-medical.com/products/barrier-protective-goggles-with-spherical-lenses> (Year: 2018).*

DeRoyal SPEyes Eye Shield Facial Protection, earliest pictured Feb. 26, 2021, [online], [site visited Dec. 22, 2022]. Available via Internet, <URL:https://sfdev.deroyal.com/products/surgical/surgical-item/!/ac-surgical-speyeseyeshieldz> (Year: 2021).*

Google Search, [online], [site visited Dec. 22, 2022]. Available via Internet, <URL:https://www.google.com/search?q+=eye+shields&tbm=isch&ved=2ahUKEwik6oHz55n8AhUvD1kFHbz8DIoQ2-cCegQIABAA&oq+=eye+shields&gs_l%E2%80%A6>(Year: 2022).*

* cited by examiner

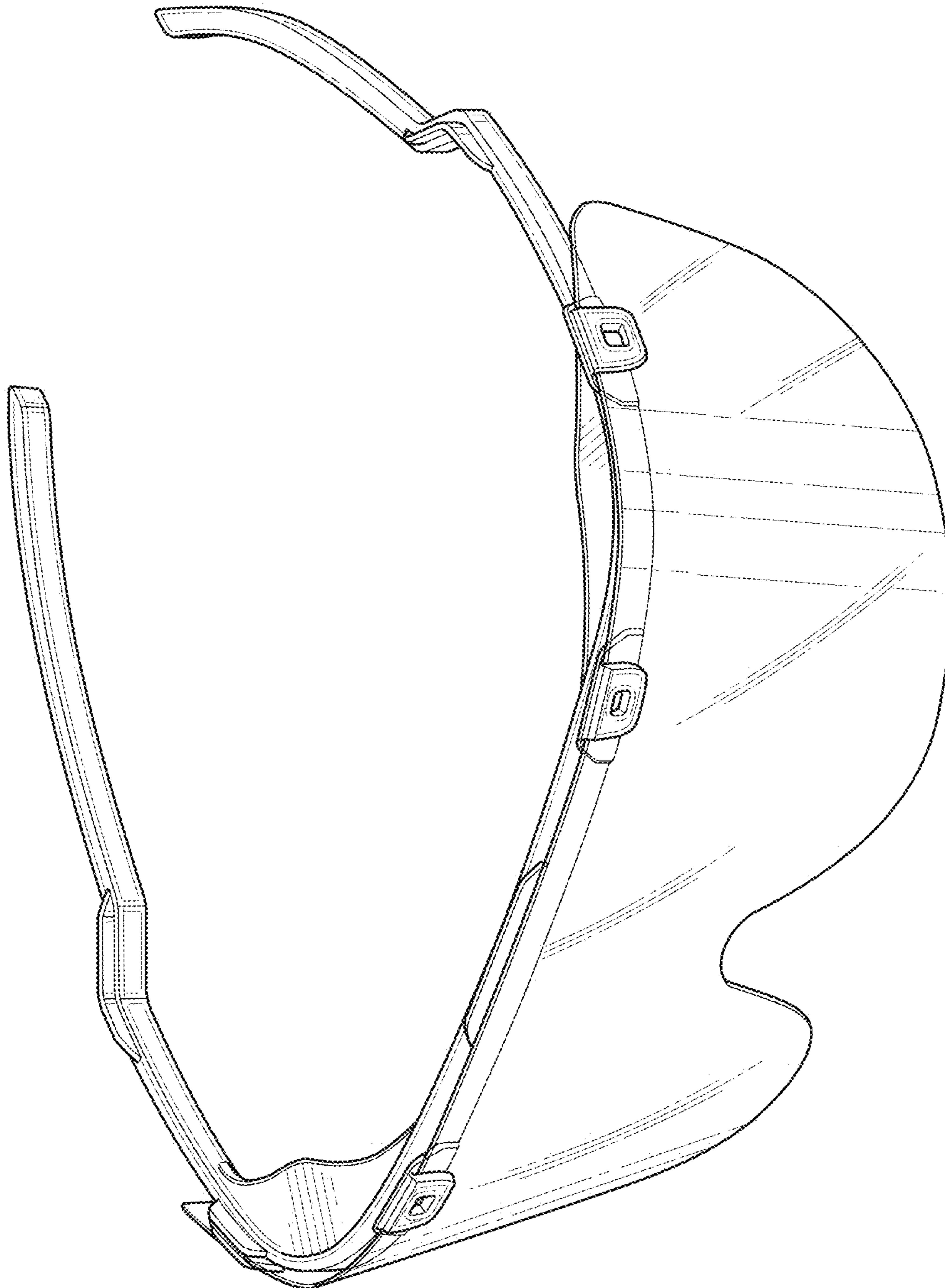

FIG. 1

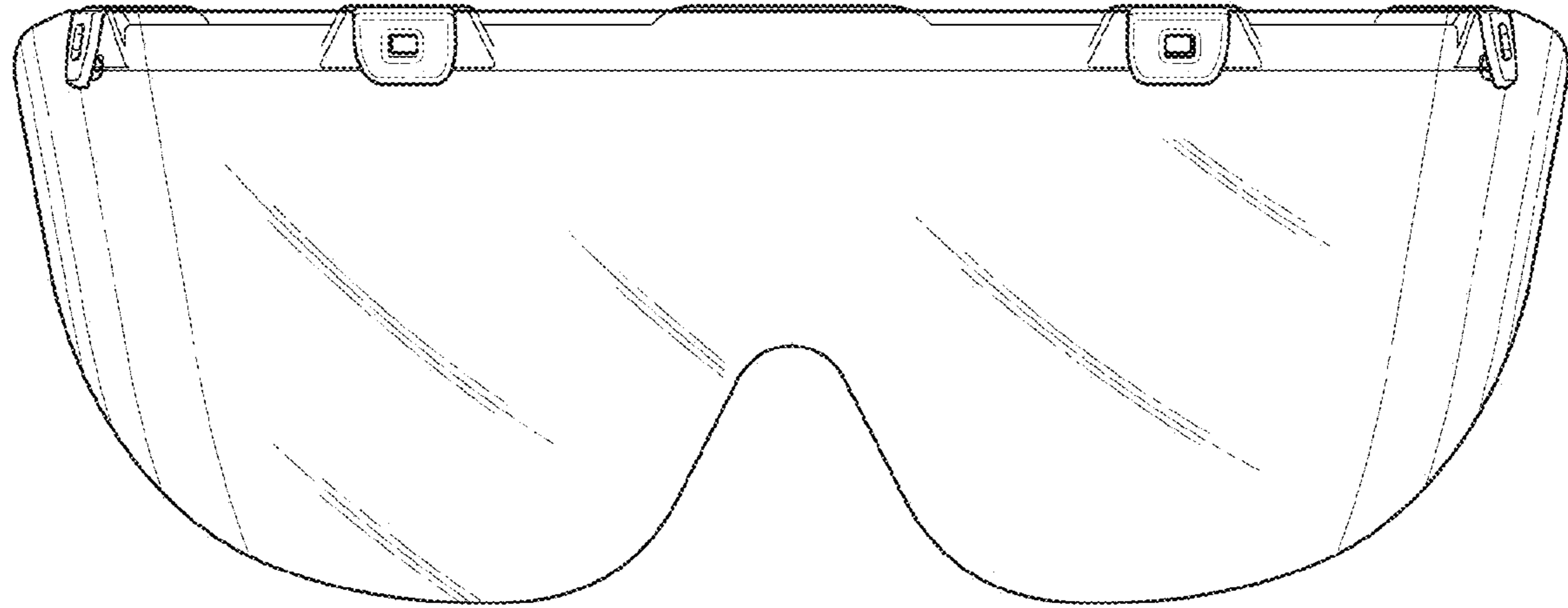

FIG. 2

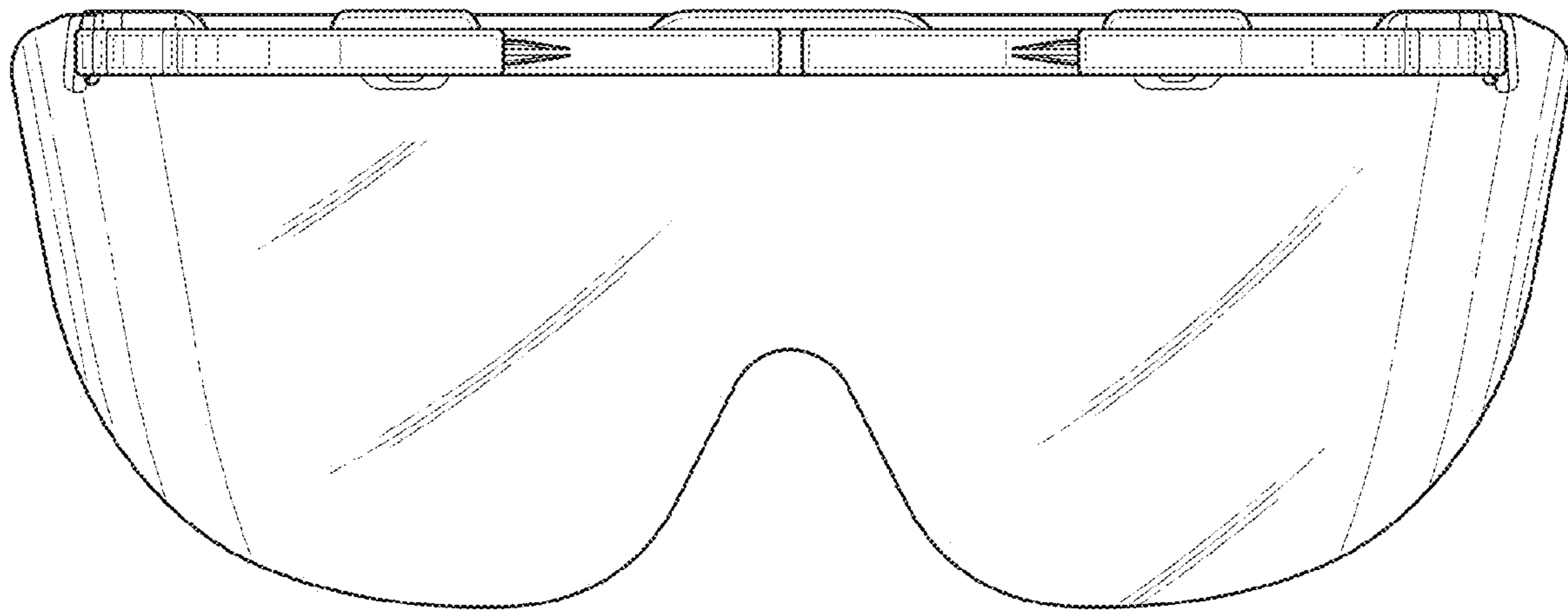

FIG. 3

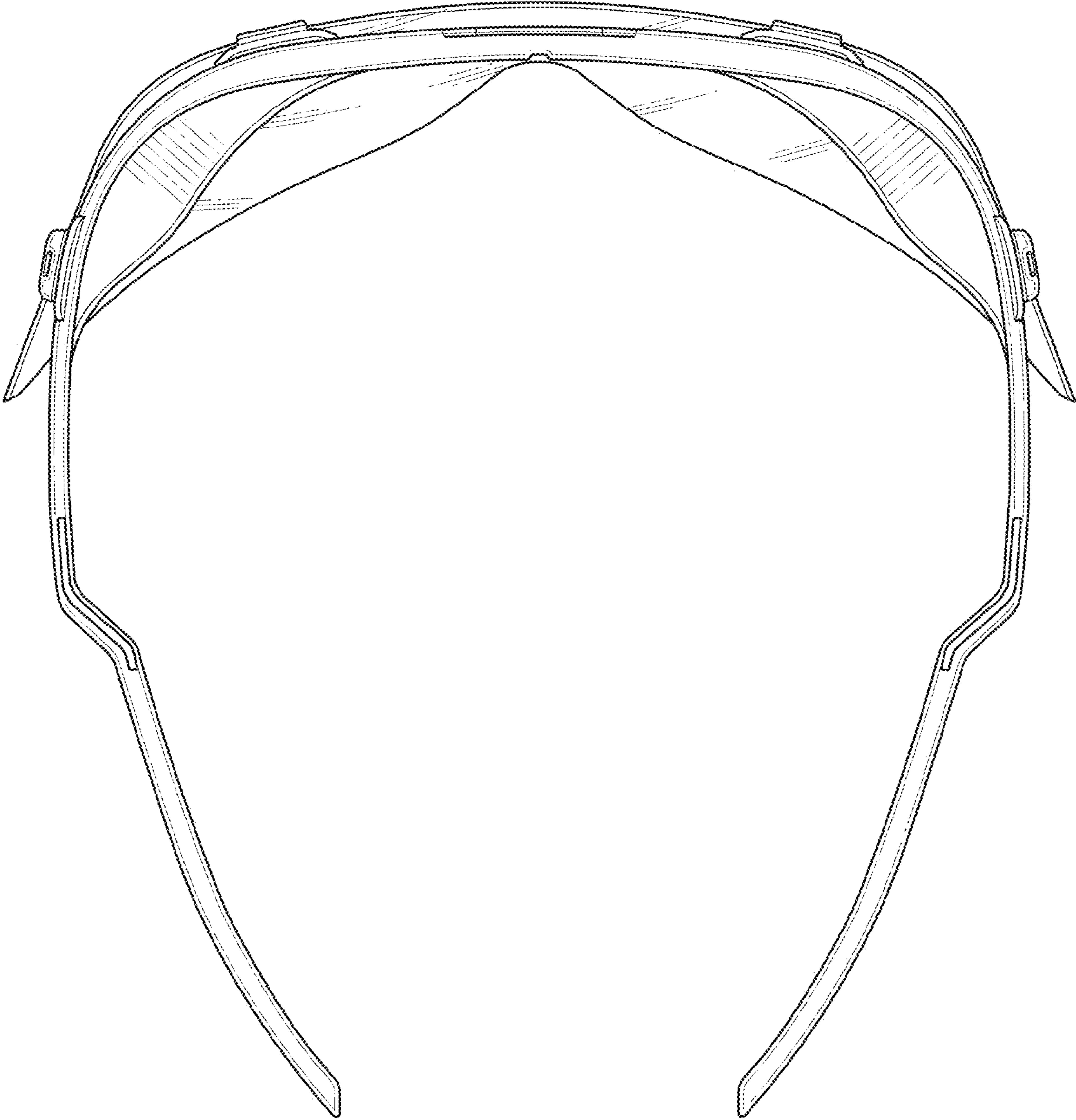

FIG. 4

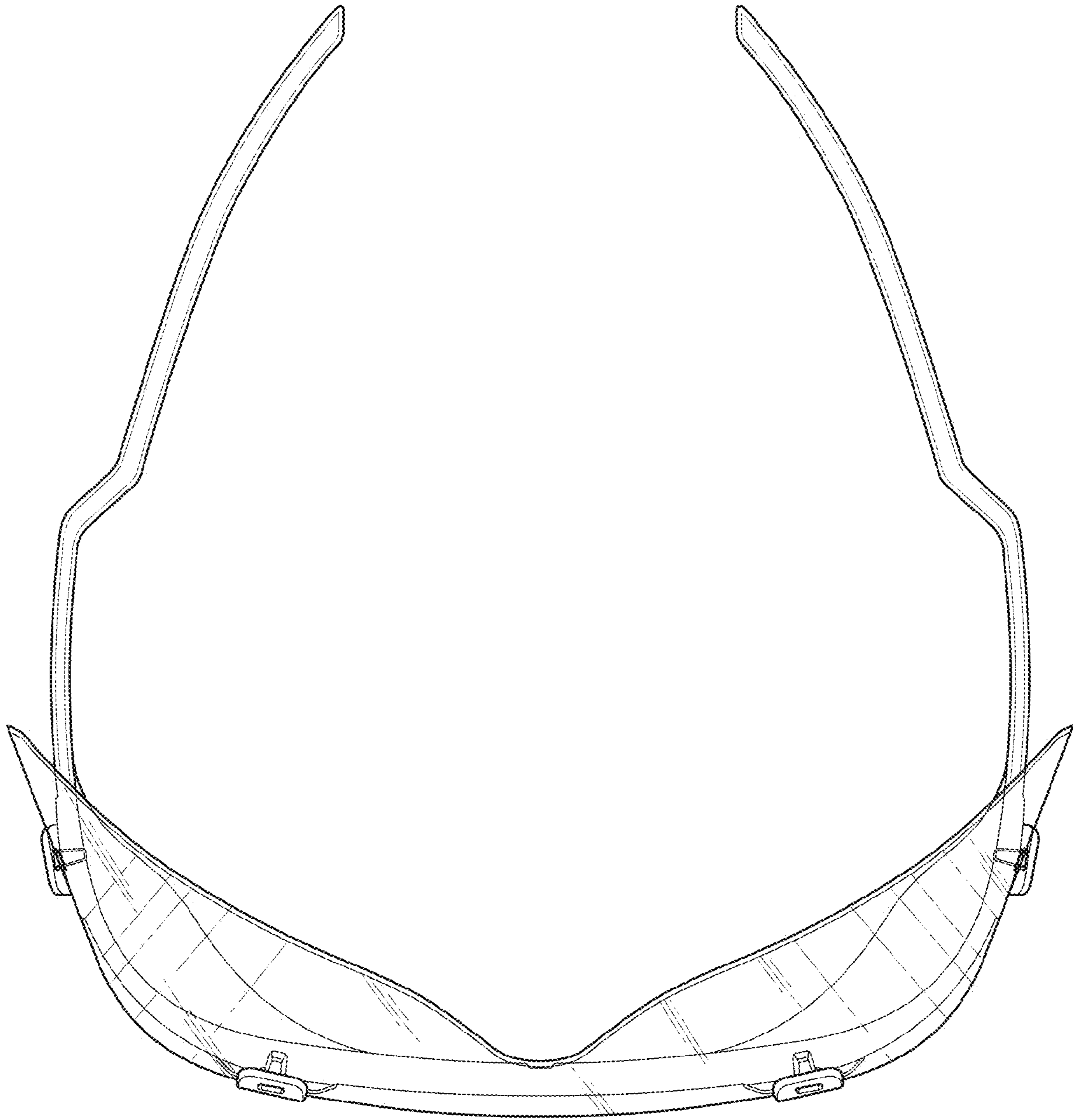

FIG. 5

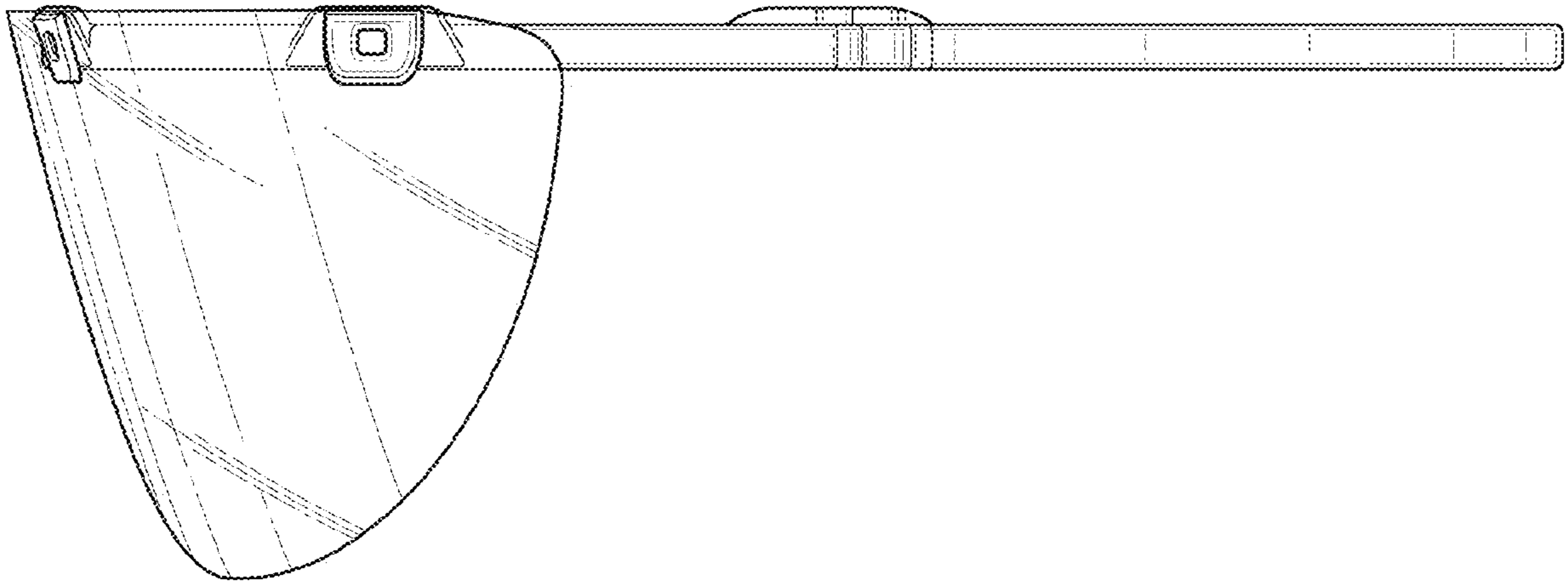

FIG. 6

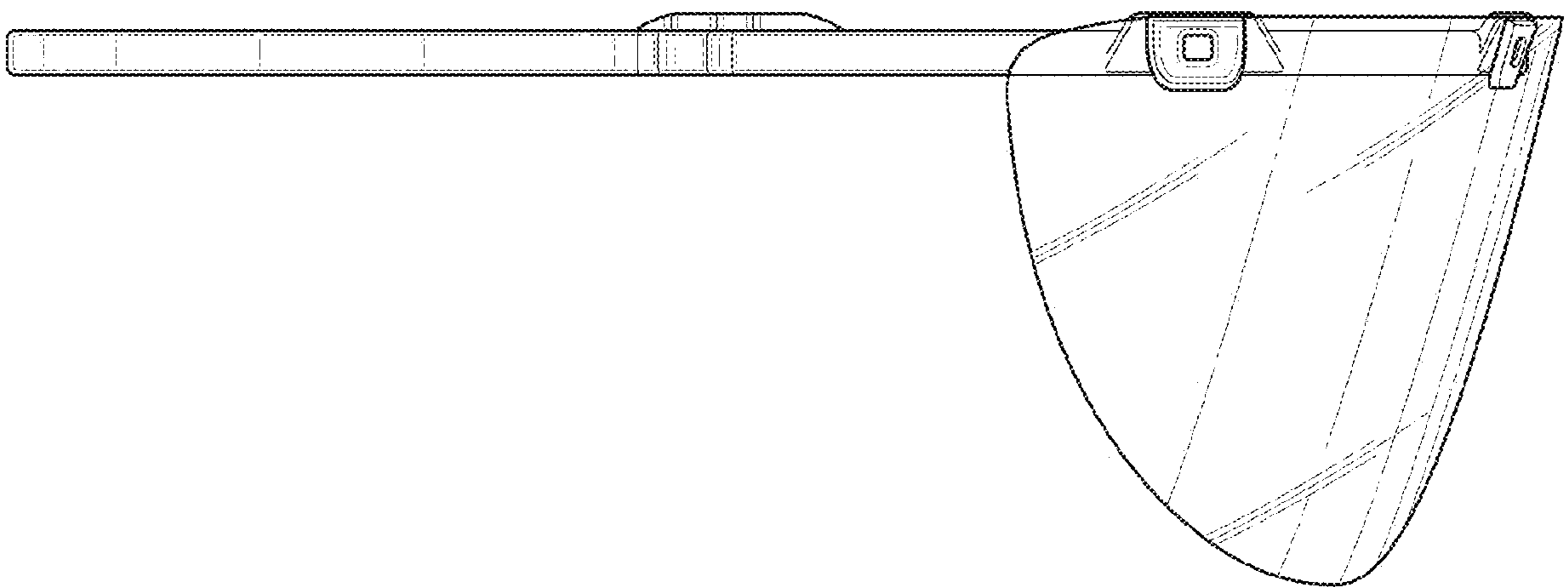

FIG. 7