



US00D983730S

(12) **United States Design Patent** (10) **Patent No.:** **US D983,730 S**
Itai (45) **Date of Patent:** **** Apr. 18, 2023**

(54) **TIRE SIDEWALL**

D740,747 S 10/2015 Sato et al.
D750,555 S * 3/2016 Iwabuchi D12/605
D778,815 S * 2/2017 Emorine D12/605
(Continued)

(71) Applicant: **BRIDGESTONE CORPORATION,**
Tokyo (JP)

(72) Inventor: **Yoko Itai,** Tokyo (JP)

(73) Assignee: **BRIDGESTONE CORPORATION,**
Tokyo (JP)

(**) Term: **15 Years**

(21) Appl. No.: **29/790,384**

(22) Filed: **Nov. 24, 2021**

(30) **Foreign Application Priority Data**

Sep. 28, 2021 (JP) 2021-020963 D

(51) **LOC (14) Cl.** **12-15**

(52) **U.S. Cl.**
USPC **D12/605**

(58) **Field of Classification Search**
USPC D12/604, 605
CPC B60C 13/00; B60C 1/00
See application file for complete search history.

(56) **References Cited**

U.S. PATENT DOCUMENTS

D556,127 S * 11/2007 Iwabuchi D12/605
D565,503 S * 4/2008 Tanaka D12/605
D565,504 S * 4/2008 Tanaka D12/605
D569,791 S * 5/2008 Iwabuchi D12/605
D574,766 S * 8/2008 Iwabuchi D12/605
D576,544 S * 9/2008 Onoe D12/605
D599,285 S * 9/2009 Misumi D12/605
D606,014 S * 12/2009 Kujime D12/605
D606,015 S * 12/2009 Kujime D12/605
D647,474 S * 10/2011 Takahashi D12/605
D649,111 S * 11/2011 Tokizaki D12/605
D663,681 S * 7/2012 Corsi D12/605

FOREIGN PATENT DOCUMENTS

JP D1080461 S 7/2000
JP D1122580 S 10/2001
(Continued)

Primary Examiner — Michelle E. Wilson

Assistant Examiner — Clese Moore, Jr.

(74) *Attorney, Agent, or Firm* — Kenja IP Law PC

(57) **CLAIM**

The ornamental design for a tire sidewall, as shown and described.

DESCRIPTION

FIG. 1 is a front perspective view of a tire sidewall showing my new design;
FIG. 2 is a front view thereof;
FIG. 3 is a top view thereof, the bottom view being identical;
FIG. 4 is a right side view thereof, the left side view being identical;
FIG. 5 is a rear view thereof;
FIG. 6 is a fragmentary enlarged front view of the portion 6 framed in FIG. 2;
FIG. 7 is a fragmentary enlarged front view of the portion 7 framed in FIG. 6;
FIG. 8 is a fragmentary enlarged front view of the portion 8 framed in FIG. 6;
FIG. 9 is an enlarged cross-section end view taken along line 9-9 in FIG. 7; and,
FIG. 10 is an enlarged cross-section end view taken along line 10-10 in FIG. 8.
Broken lines show environmental portions of a tire that are not being claimed, and form no part of the claimed design.

1 Claim, 10 Drawing Sheets

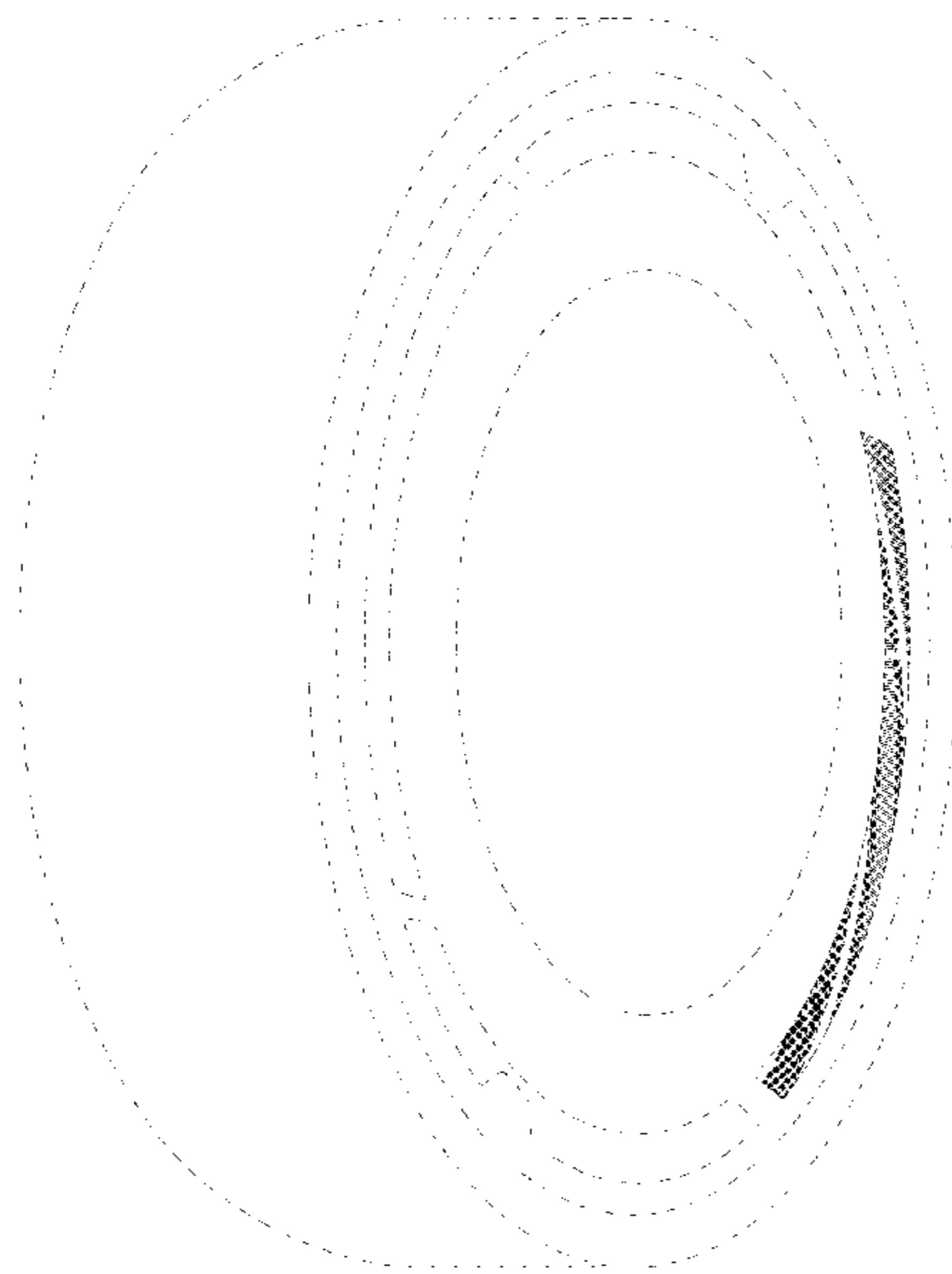

(56)

References Cited

U.S. PATENT DOCUMENTS

D789,879	S	*	6/2017	Itoi	D12/605
D791,068	S	*	7/2017	Ishikawa	D12/605
D802,526	S	*	11/2017	Ishikawa	D12/605
D829,643	S	*	10/2018	Mita	D12/605
D830,960	S	*	10/2018	Sato	D12/605
D843,928	S	*	3/2019	Whitaker	D12/605
D853,950	S	*	7/2019	Kubota	D12/605
D873,764	S	*	1/2020	Wakasugi	D12/605
D873,765	S		1/2020	Wakasugi	
D894,114	S	*	8/2020	Fontaine	D12/605
D903,582	S	*	12/2020	Kamada	D12/605
D906,950	S	*	1/2021	Nakamura	D12/605
D906,952	S	*	1/2021	Nakamura	D12/605

FOREIGN PATENT DOCUMENTS

JP	D1122906	S	10/2001
JP	D1155722	S	10/2002
JP	D1333520	S	6/2008
JP	D1336833	S	7/2008
JP	D1522895	S	5/2015
JP	D1561734	S	10/2016
JP	D1596226	S	1/2018
JP	D1578779	S	6/2018
JP	D1611256	S	8/2018
JP	D1641849	S	9/2019
KR	300904306	S	4/2017
KR	300904307	S	4/2017
WO	DM/098759		6/2018
WO	DM/096247		7/2018

* cited by examiner

FIG. 1

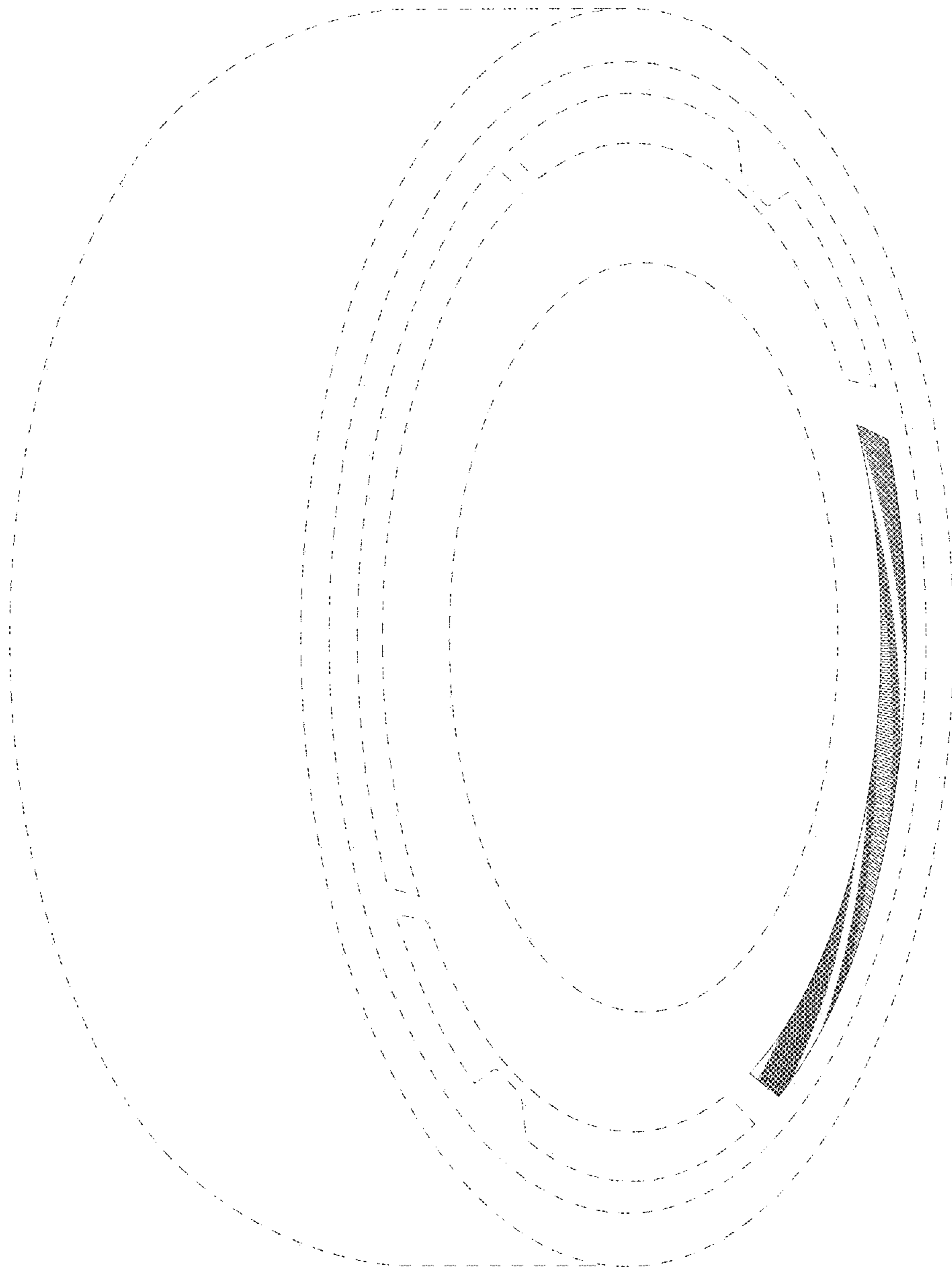

FIG. 2

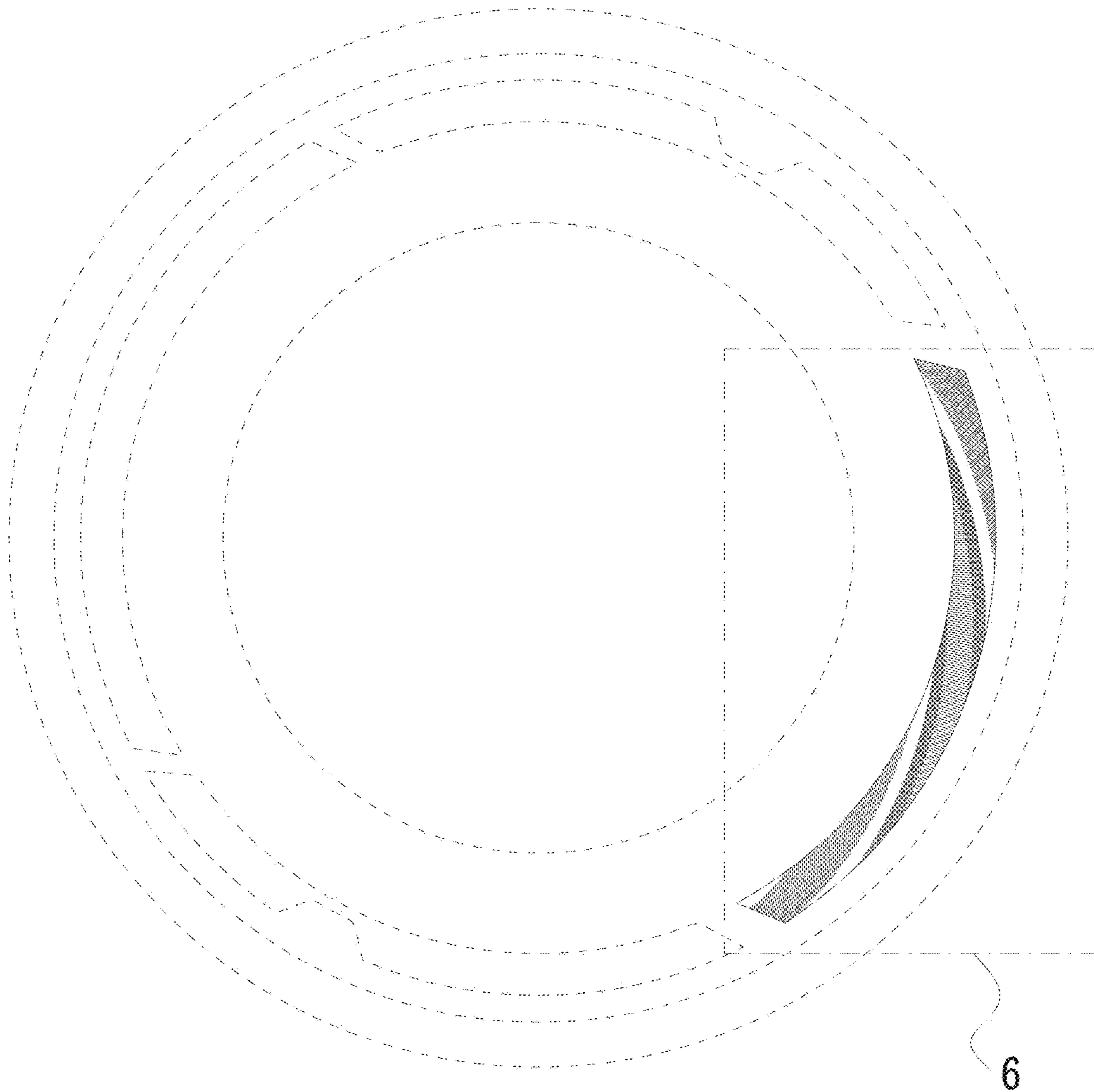

FIG. 3



FIG. 4

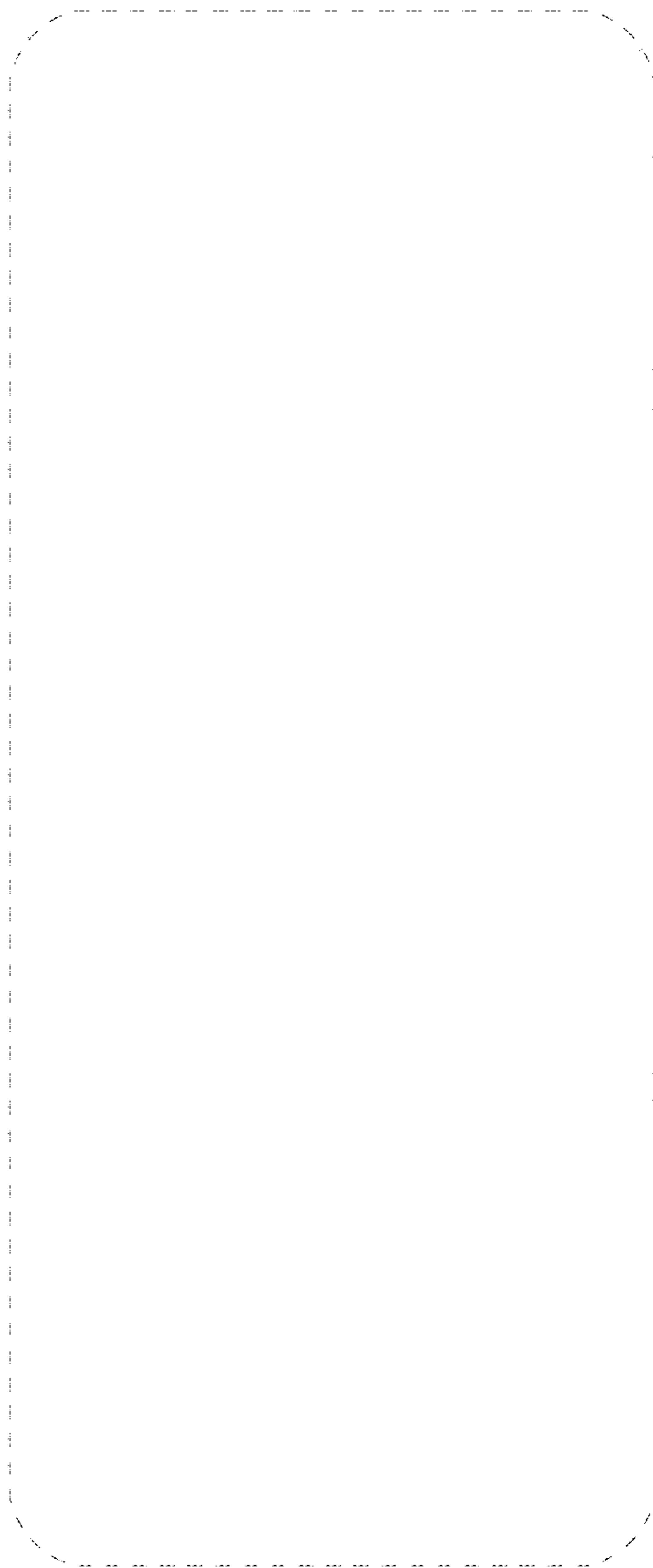

FIG. 5

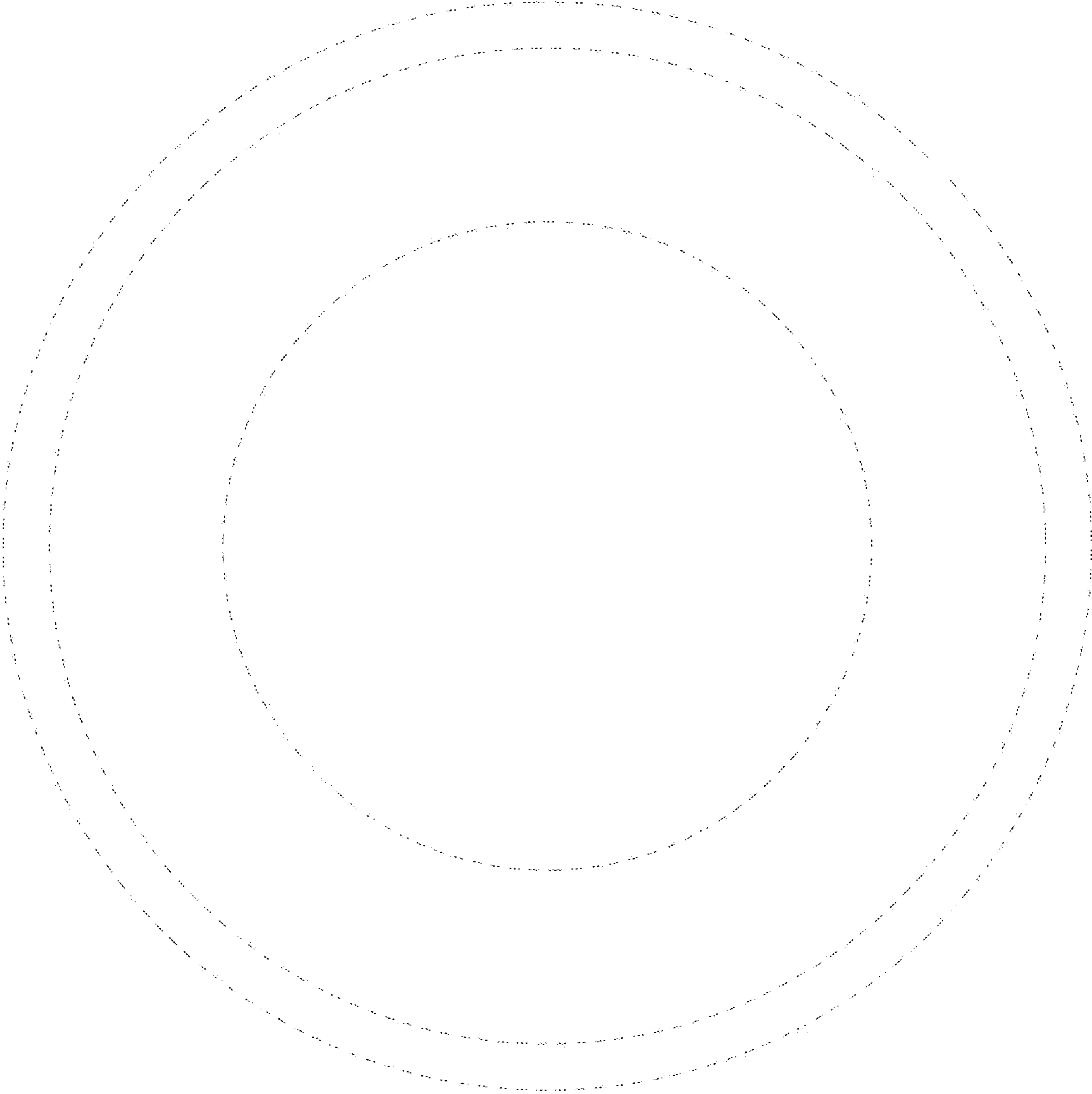

FIG. 6

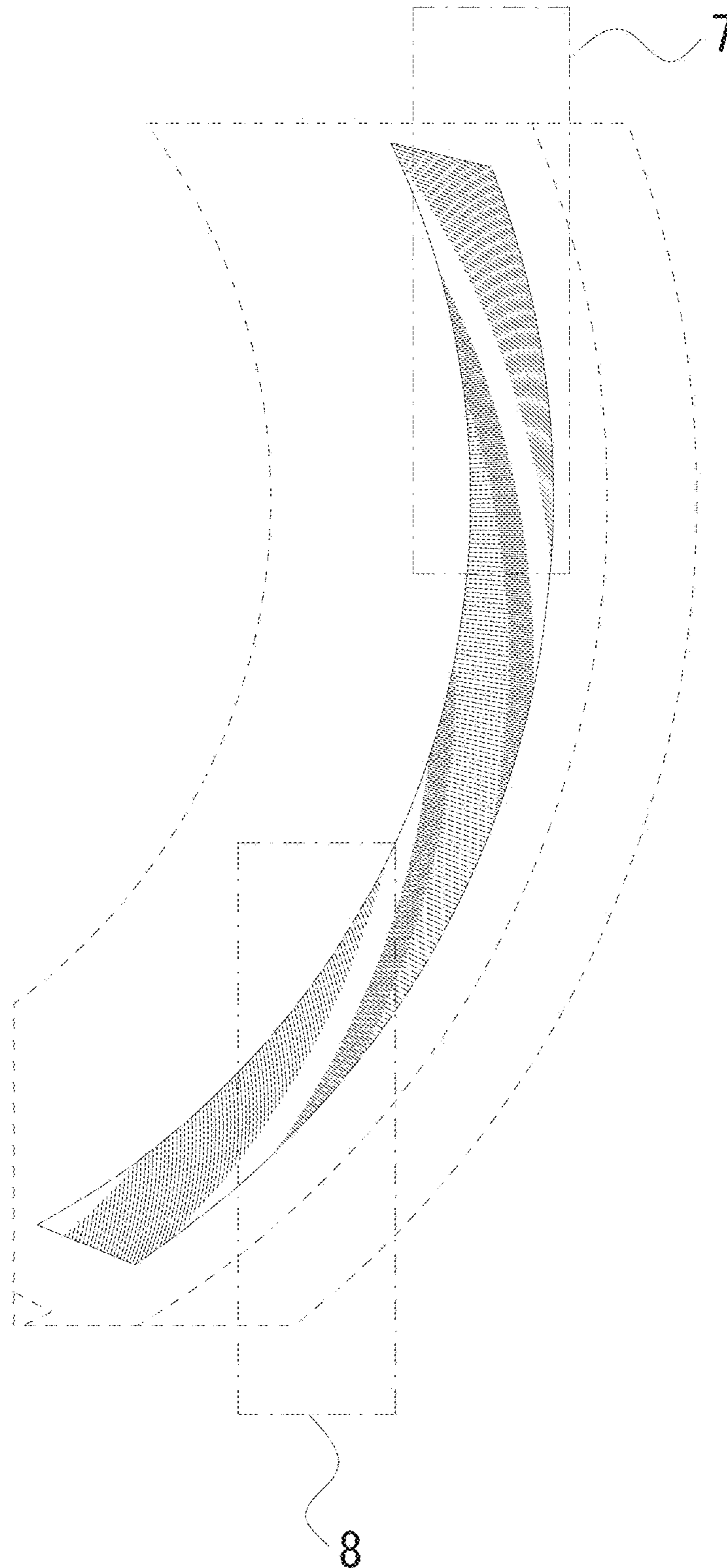

FIG. 7

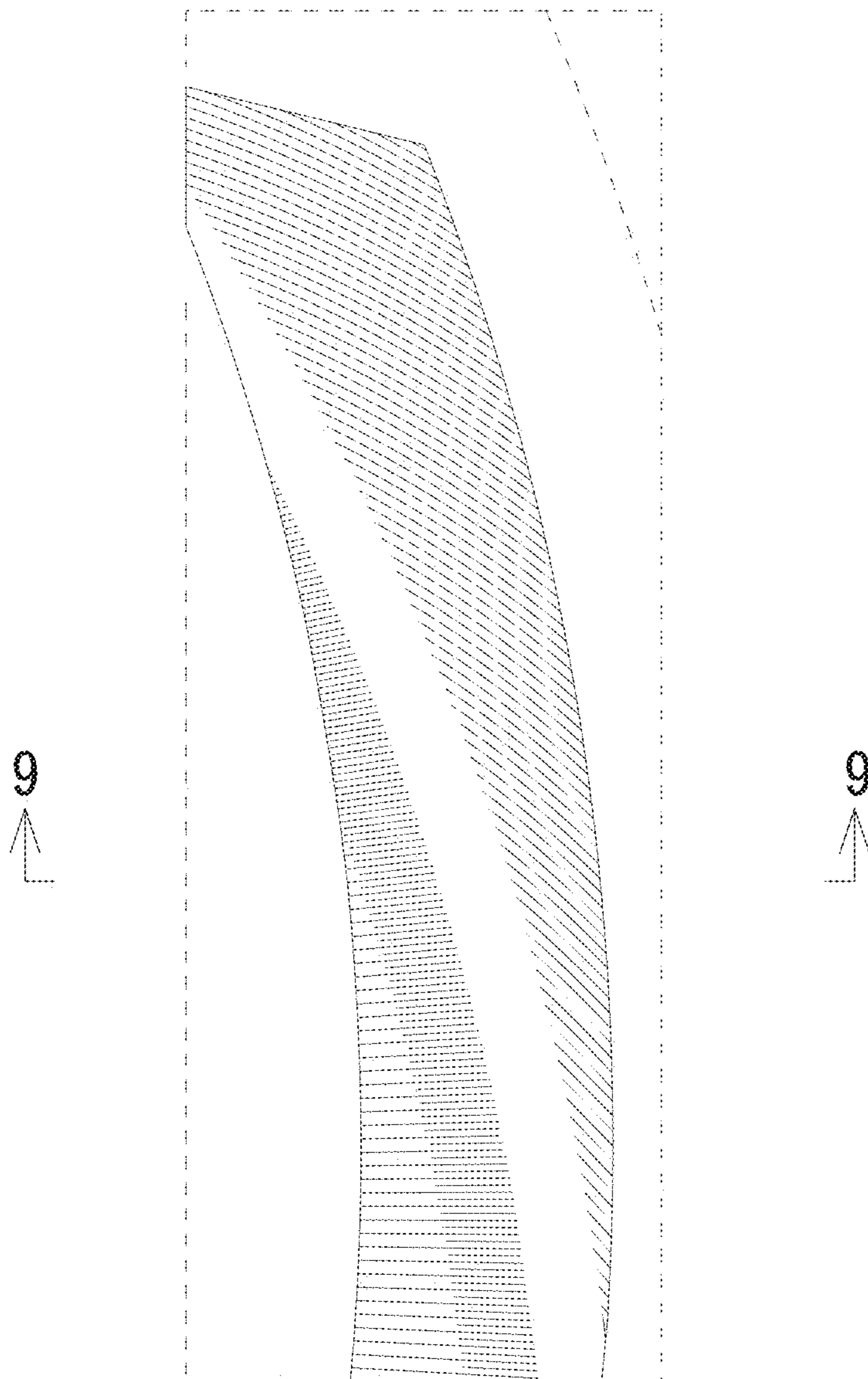

FIG. 8

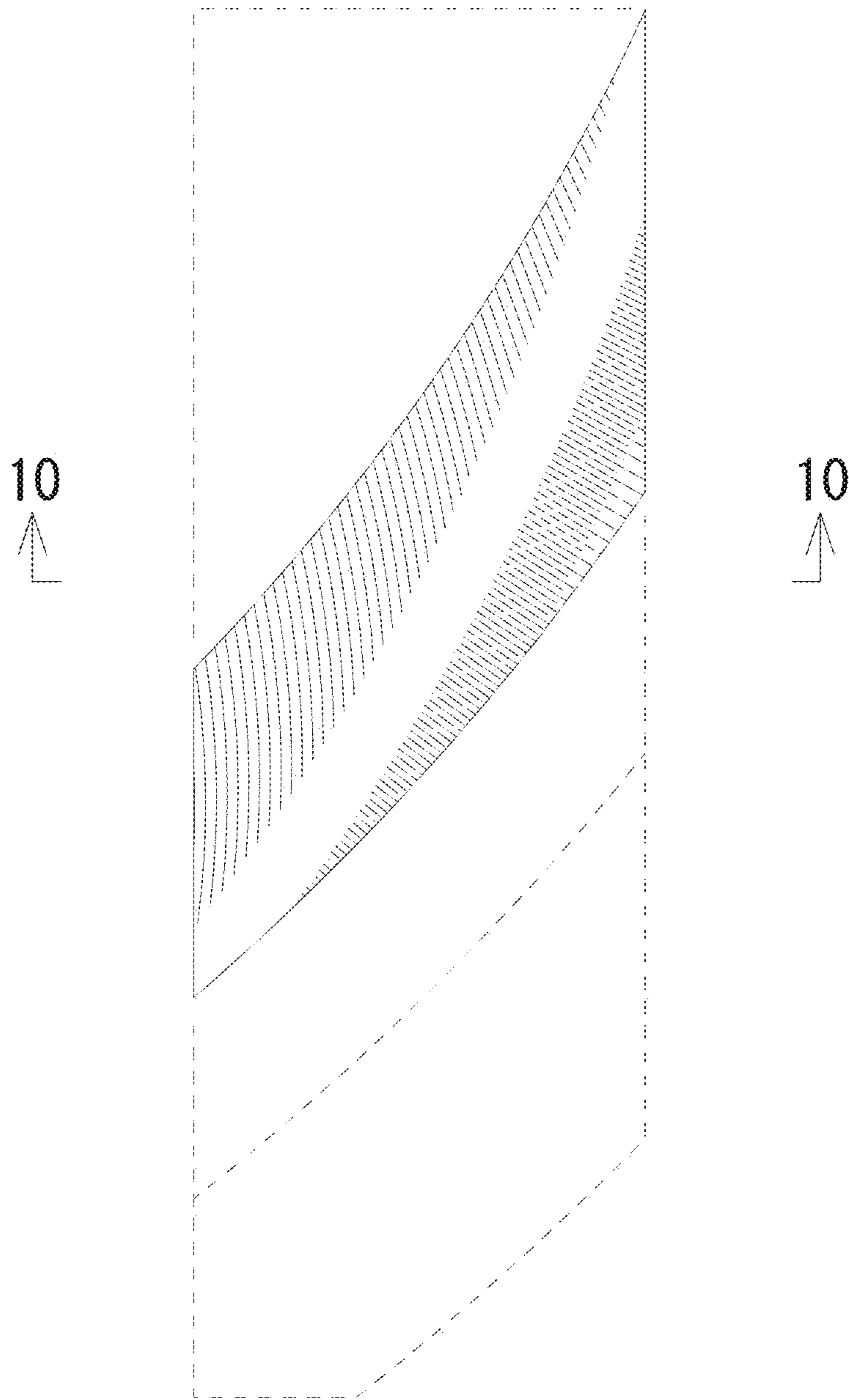

FIG. 9

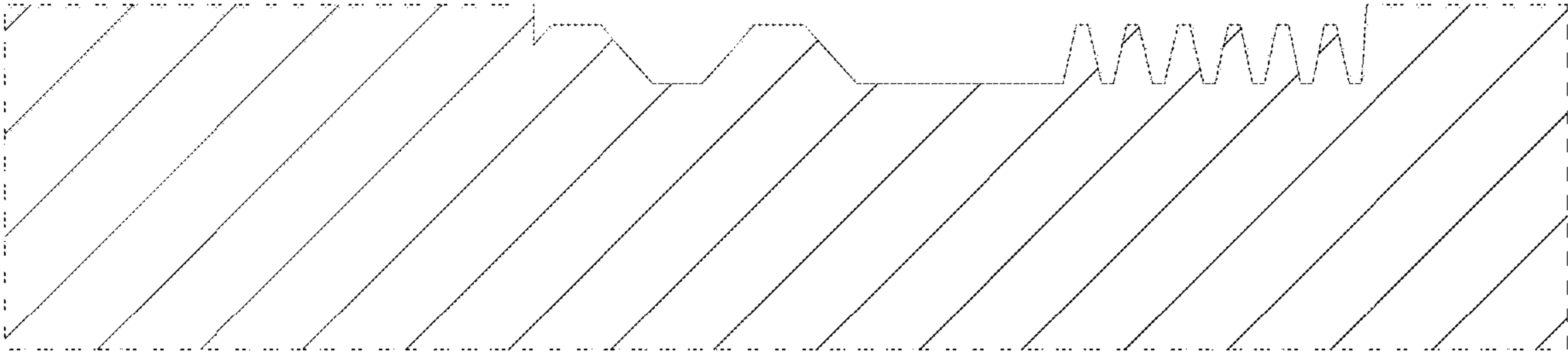

FIG. 10

