



US00D983722S

(12) **United States Design Patent**
Deng

(10) **Patent No.:** **US D983,722 S**

(45) **Date of Patent:** **** Apr. 18, 2023**

(54) **CAR HANDLE**

(71) Applicant: **Yuyao Jinpu Electric Co., Ltd.**, Yuyao (CN)

(72) Inventor: **Xinhua Deng**, Yuyao (CN)

(**) Term: **15 Years**

(21) Appl. No.: **29/833,229**

(22) Filed: **Apr. 1, 2022**

(51) **LOC (14) Cl.** **12-16**

(52) **U.S. Cl.**
USPC **D12/400**

(58) **Field of Classification Search**
USPC D12/167, 169, 178, 184, 190, 400, 406,
D12/412, 414; D8/14, 30, 40, 45, 94,
D8/107, 300, 301, 302, 303, 315, 316,
D8/319; D15/89; D23/304; D25/41.1;
D34/27

CPC A47K 3/003; E05B 1/0015; B62K 21/26
See application file for complete search history.

(56) **References Cited**

U.S. PATENT DOCUMENTS

D175,577 S *	9/1955	Young	D8/30
D236,579 S *	9/1975	Morhack	D7/649
D326,594 S *	6/1992	Haberman	D8/30
D463,244 S *	9/2002	Chen	D8/107
D516,009 S *	2/2006	Kontorovich	D8/14
D600,626 S *	9/2009	Miller	D12/400
D642,889 S *	8/2011	Boehm	D8/107
D663,913 S *	7/2012	Alder	D34/35
D743,324 S *	11/2015	Deng	D12/400

D758,949 S *	6/2016	Tran	D12/345
D762,158 S	7/2016	Hollinger		
9,403,466 B1 *	8/2016	Deng	F21L 4/00
D766,809 S *	9/2016	Deng	D12/400
D875,799 S *	2/2020	Crowe	D8/30
D898,654 S	10/2020	Huang		

OTHER PUBLICATIONS

Byojia, Published May 23, 2022 [online], [retrieved on Sep. 7, 2022]. Retrieved from the Internet: <https://www.amazon.com/Portable-Automotive-Multifunction-Flashlight-Handicapped/dp/B0B1ZM8N1F> (Year: 2022).*

* cited by examiner

Primary Examiner — Cary M Robinson
Assistant Examiner — Adam C Mager

(57) **CLAIM**

The ornamental design for a car handle, as shown and described.

DESCRIPTION

FIG. 1 is a perspective view of a car handle, showing my new design;
FIG. 2 is another perspective view thereof;
FIG. 3 is a front elevational view thereof;
FIG. 4 is a rear elevational view thereof;
FIG. 5 is a left elevational view thereof;
FIG. 6 is a right elevational view thereof;
FIG. 7 is a top plan view thereof; and,
FIG. 8 is a bottom plan view thereof.

1 Claim, 8 Drawing Sheets

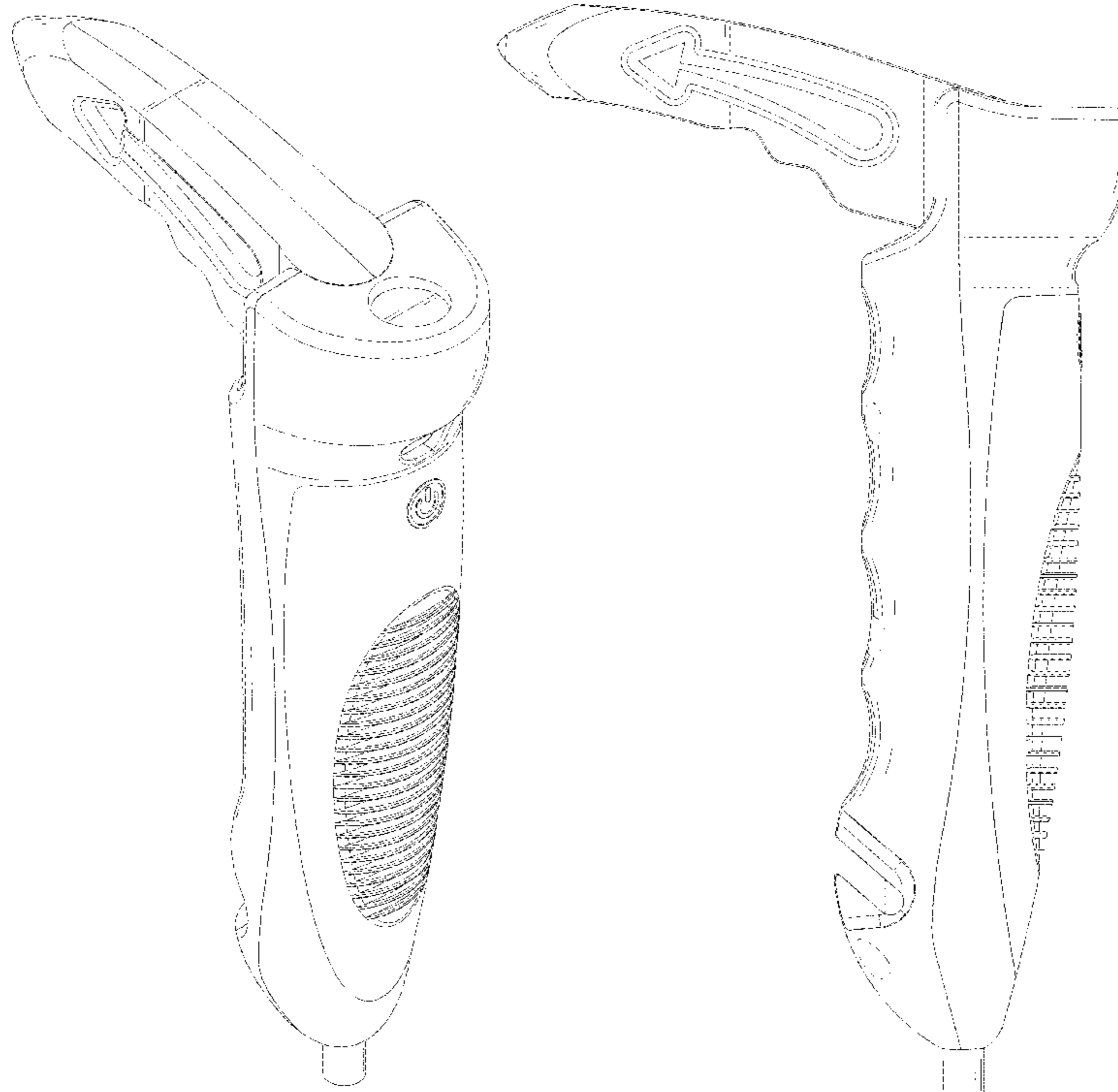

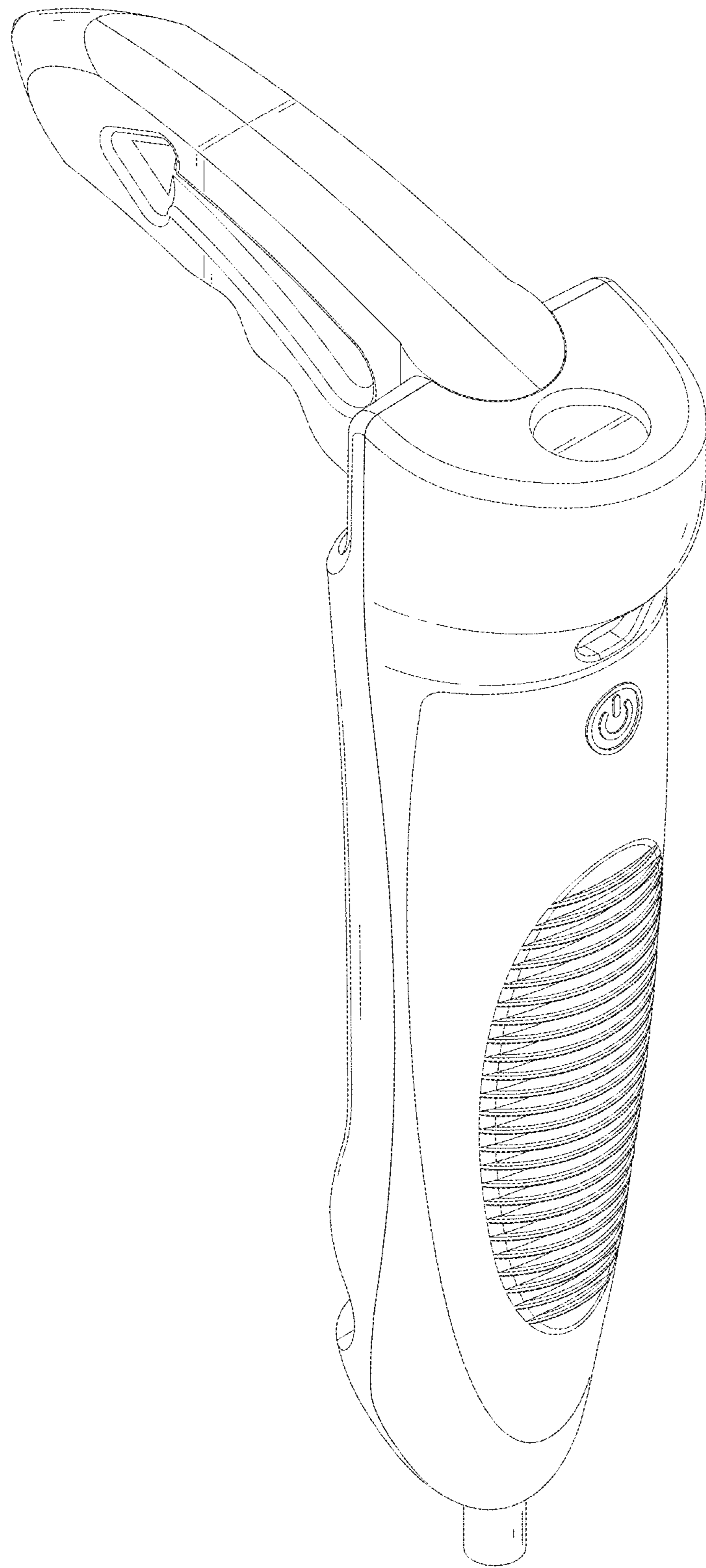

FIG.1

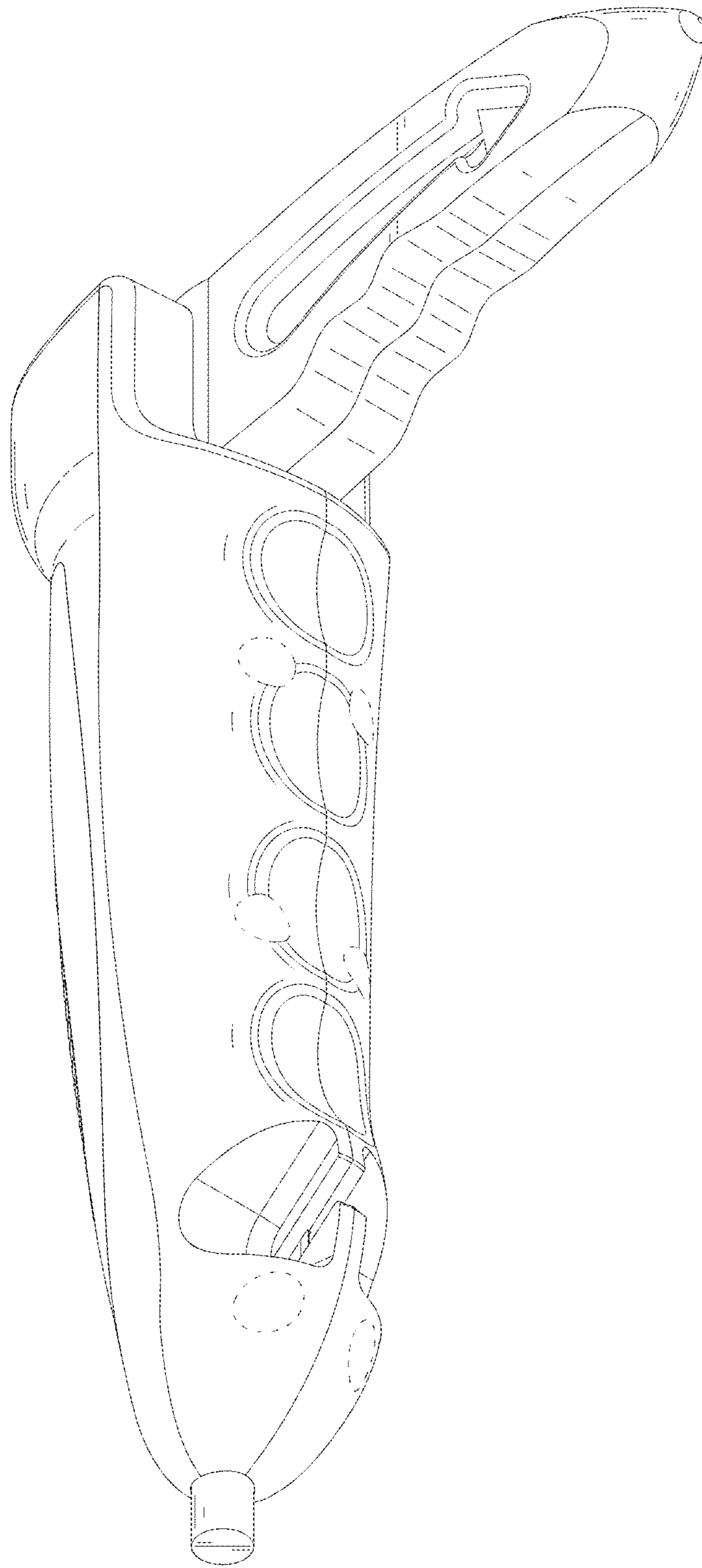

FIG.2

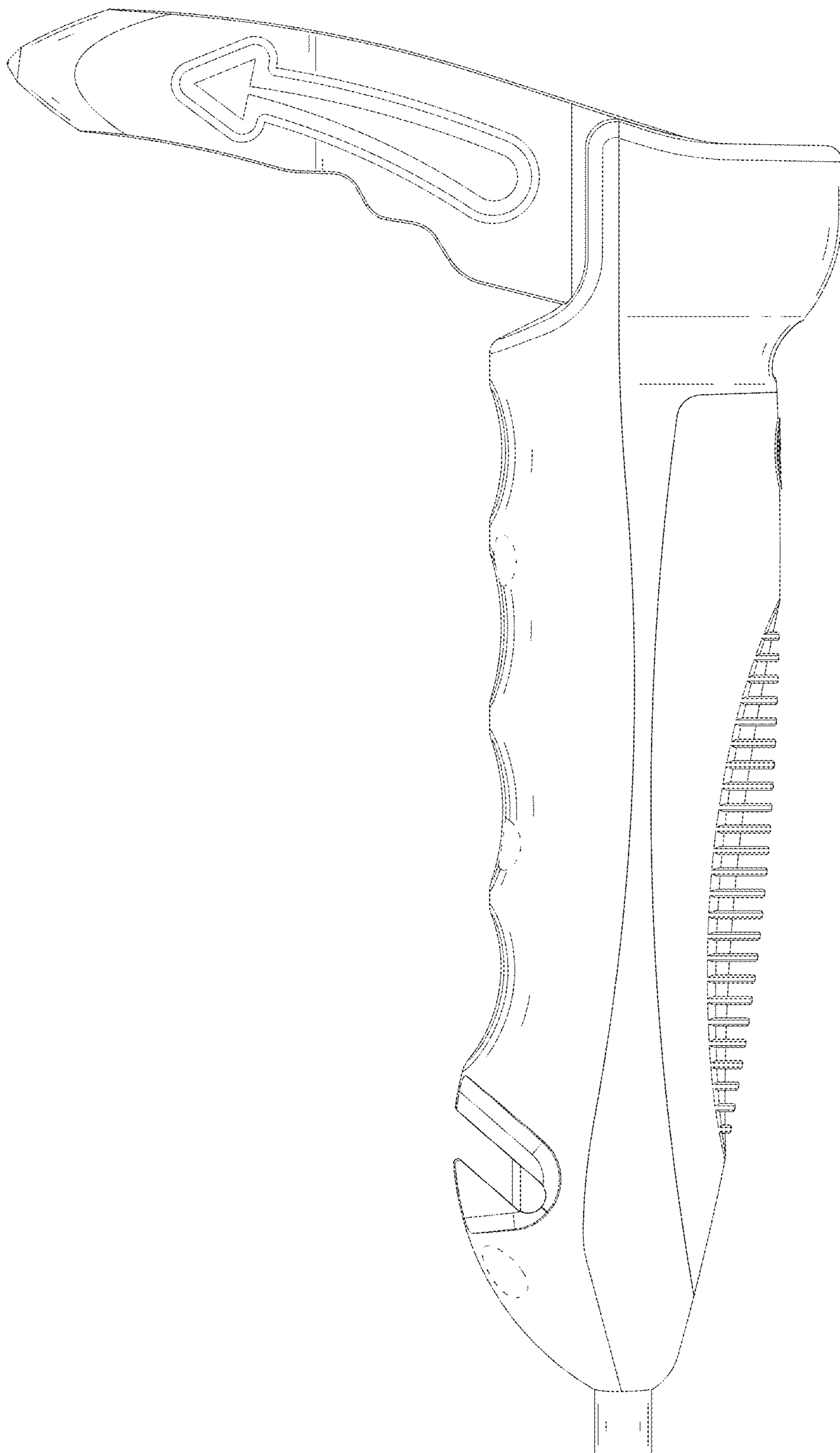

FIG.3

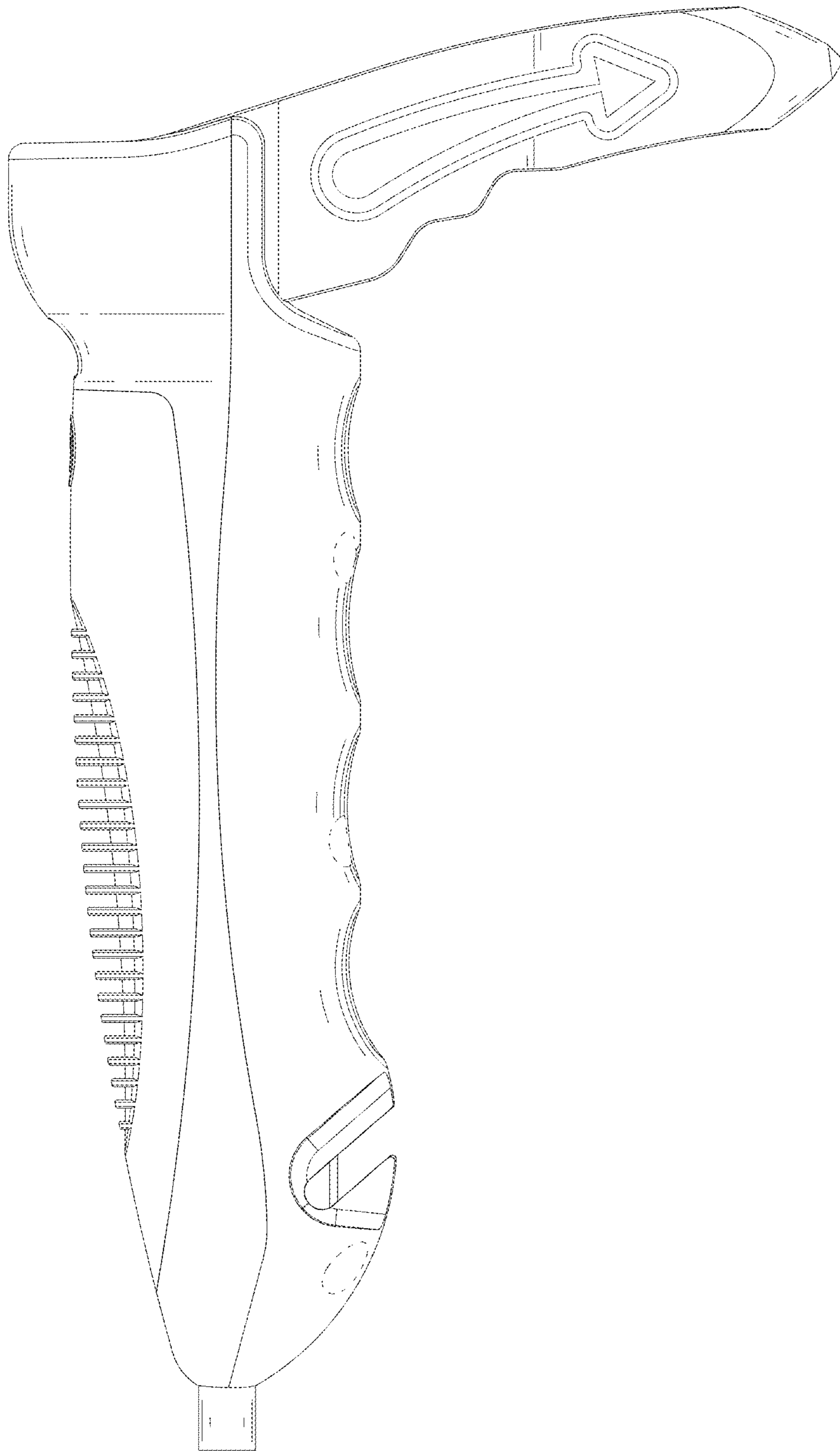

FIG.4

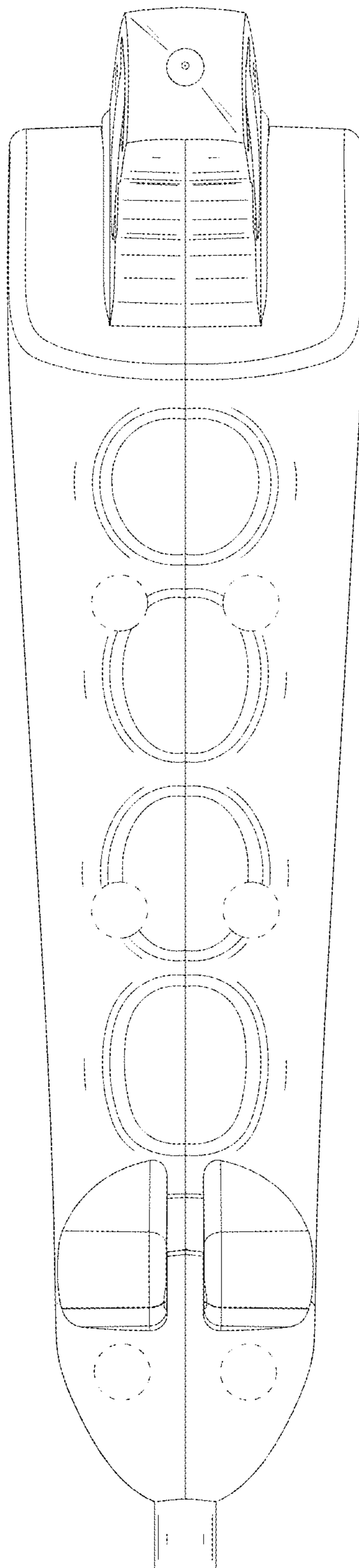

FIG.5

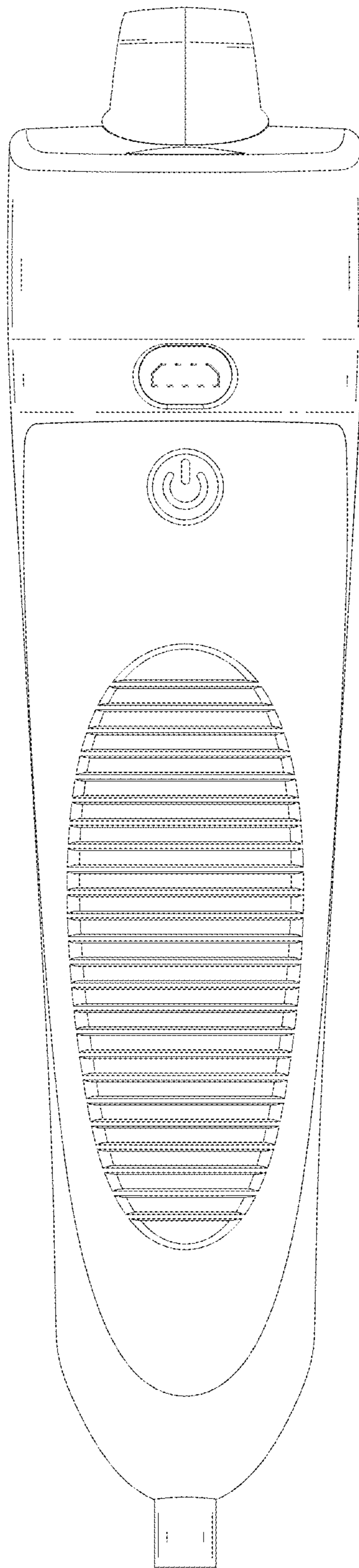

FIG.6

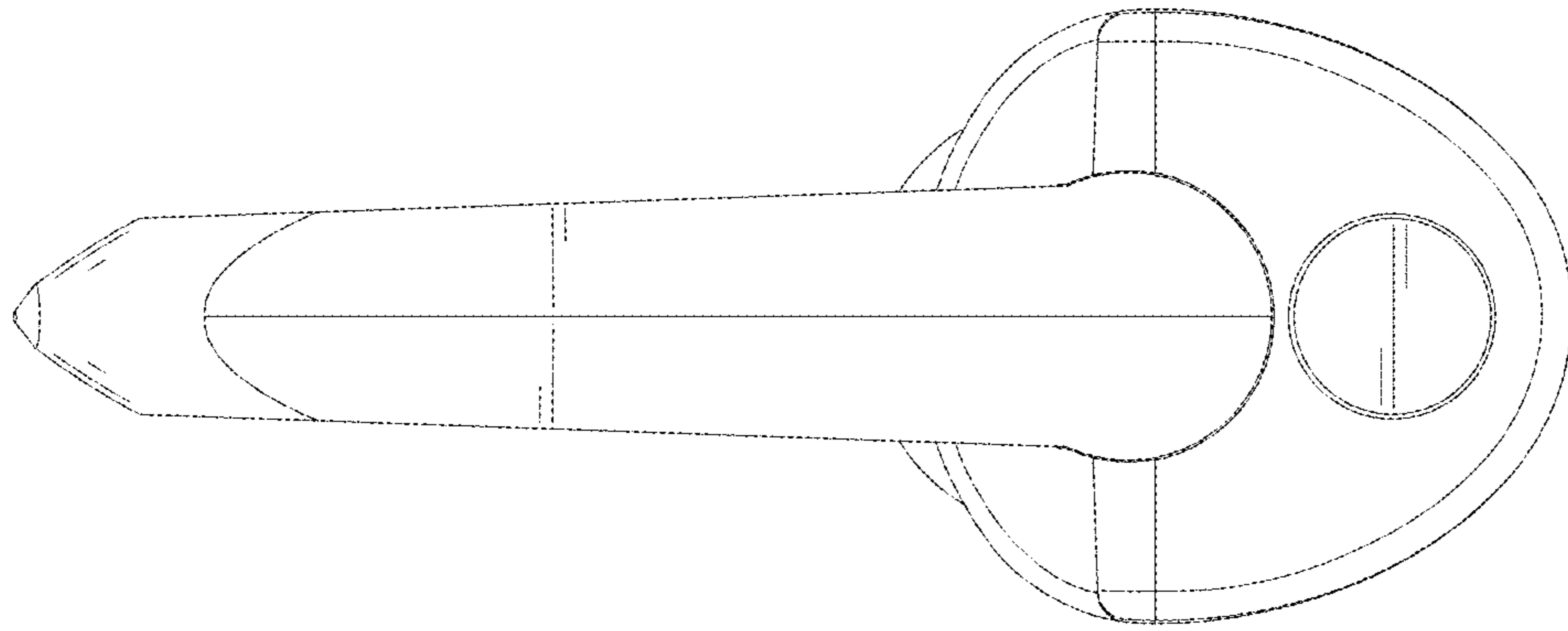

FIG. 7

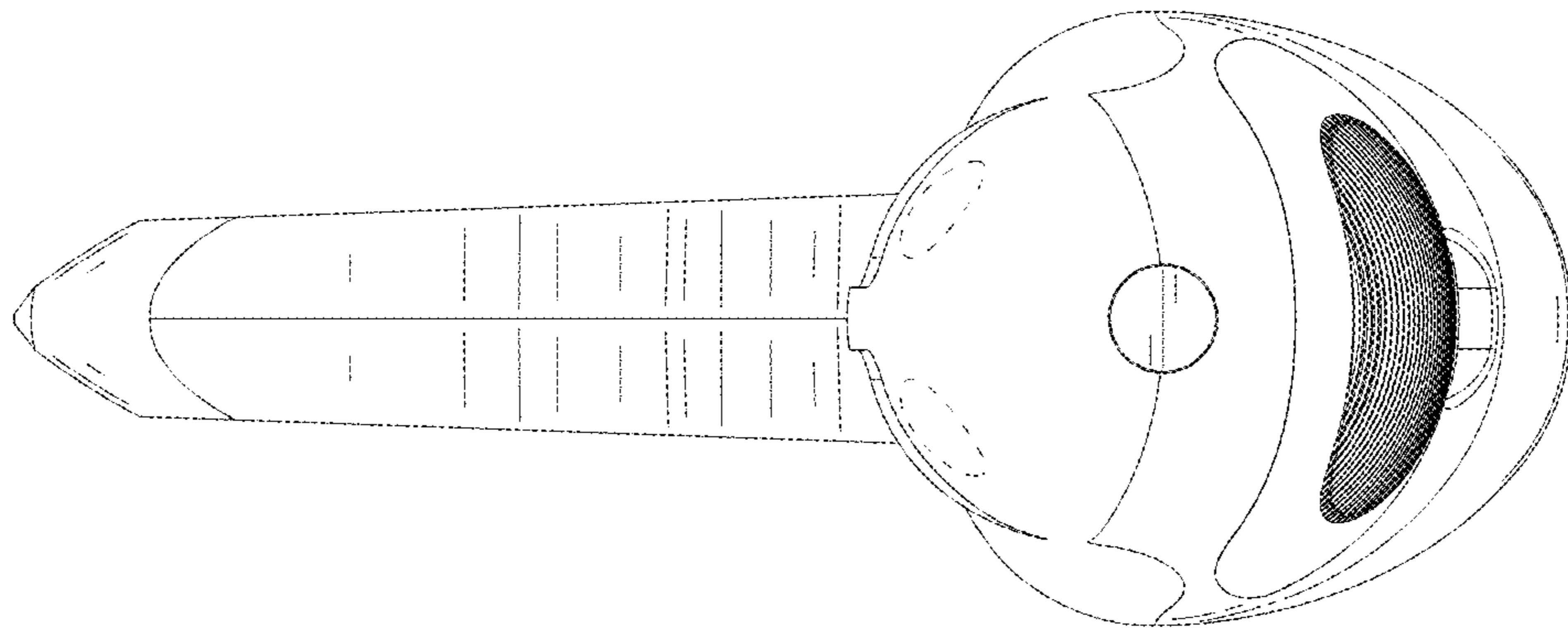

FIG.8