



US00D983560S

(12) **United States Design Patent**
Wang

(10) **Patent No.:** **US D983,560 S**
(45) **Date of Patent:** **** Apr. 18, 2023**

(54) **DISPLAY HANGER**
(71) Applicant: **Mengjin Wang**, Guangdong (CN)
(72) Inventor: **Mengjin Wang**, Guangdong (CN)
(**) Term: **15 Years**
(21) Appl. No.: **29/852,889**
(22) Filed: **Sep. 9, 2022**

D394,775 S * 6/1998 Anderson D6/574
D404,952 S * 2/1999 Bauer D6/552
D631,732 S 2/2011 Krawczak
D705,577 S * 5/2014 Goodman D6/572
D743,779 S * 11/2015 Cohen D8/371
D786,580 S * 5/2017 Chesterton D6/552
D827,030 S 8/2018 Wear
D860,677 S * 9/2019 Chesterton D6/552
D878,095 S * 3/2020 Dunahay D6/553
D916,513 S * 4/2021 Kuang D6/567
D953,065 S * 5/2022 Wang D6/567

(51) **LOC (14) Cl.** **06-04**
(52) **U.S. Cl.**
USPC **D6/552**
(58) **Field of Classification Search**
USPC D6/567, 671, 672, 673, 675, 675.1, 705,
D6/512, 524, 552, 553, 572, 573, 574,
D6/569; D11/132, 131, 140; D20/10,
D20/19, 42; D3/903, 904; D19/9, 20;
D7/354; D8/345, 363, 367, 371-373, 380
CPC A47F 3/00; A47F 5/00; A47F 5/11; A47F
7/00; B65D 5/52; G09F 5/00; G09F 5/02;
A47G 1/0616; A47G 1/00; A47G
2001/005; A47G 1/06; A47G 1/0605;
A47G 2001/0677; A63F 13/00; A47J
37/00; A47J 36/00; A47J 37/01
See application file for complete search history.

OTHER PUBLICATIONS

Amazon.com, Goutoport's Medal Holder Display Hanger rack Frame, May 17, 2022, <https://www.amazon.com/Goutoport's-Display-Runner-She-Believed-Sturdy/dp/B0B1J2Z7KX/> (Year: 2022).*

* cited by examiner

Primary Examiner — Nathan M Johnston

(57) **CLAIM**

The ornamental design for a display hanger, as shown and described.

DESCRIPTION

FIG. 1 is a front, left and top side perspective view of a display hanger showing my new design;
FIG. 2 is a front elevational view thereof;
FIG. 3 is a back elevational view thereof;
FIG. 4 is a bottom plan view thereof;
FIG. 5 is a top plan view thereof;
FIG. 6 is a left side elevational view thereof; and,
FIG. 7 is a right side elevational view thereof.

1 Claim, 7 Drawing Sheets

(56) **References Cited**
U.S. PATENT DOCUMENTS

D171,222 S * 12/1953 Odium D6/574
D310,762 S * 9/1990 Embree D6/569
4,984,693 A * 1/1991 Belokin, Jr. A47F 5/0876
D6/567
D327,197 S * 6/1992 Belokin, Jr. D6/567

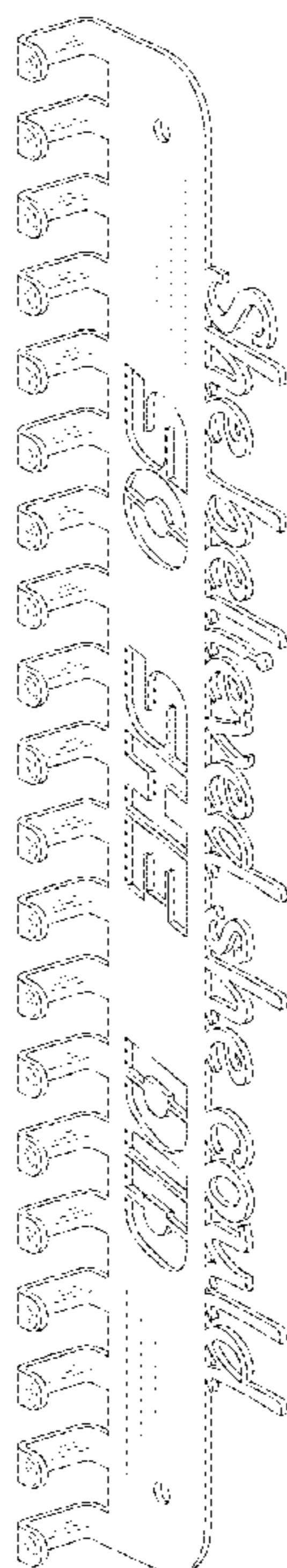

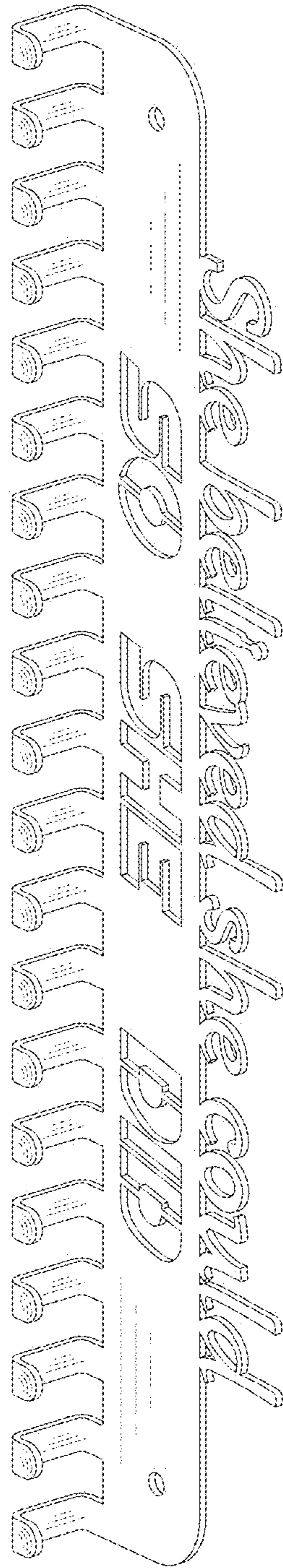

FIG. 1

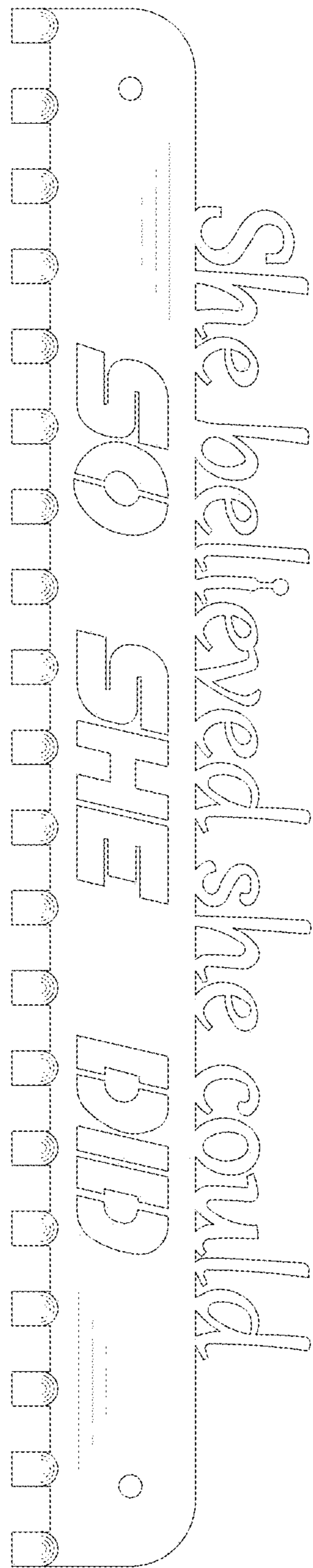

FIG. 2

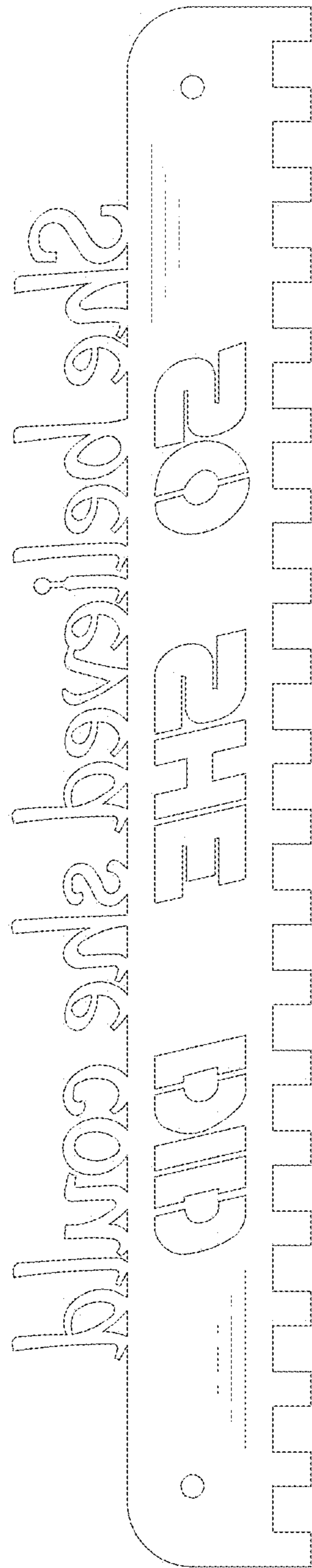

FIG. 3

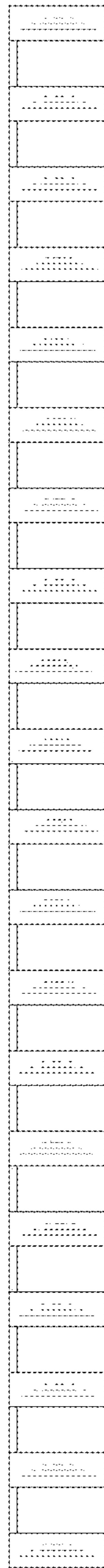

FIG. 4

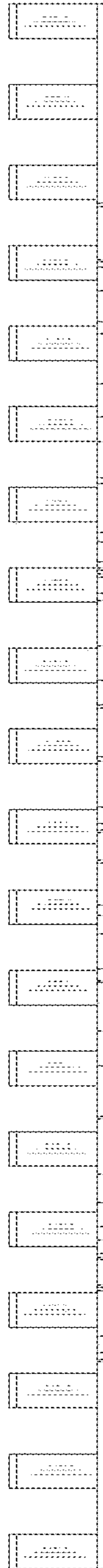

FIG. 5

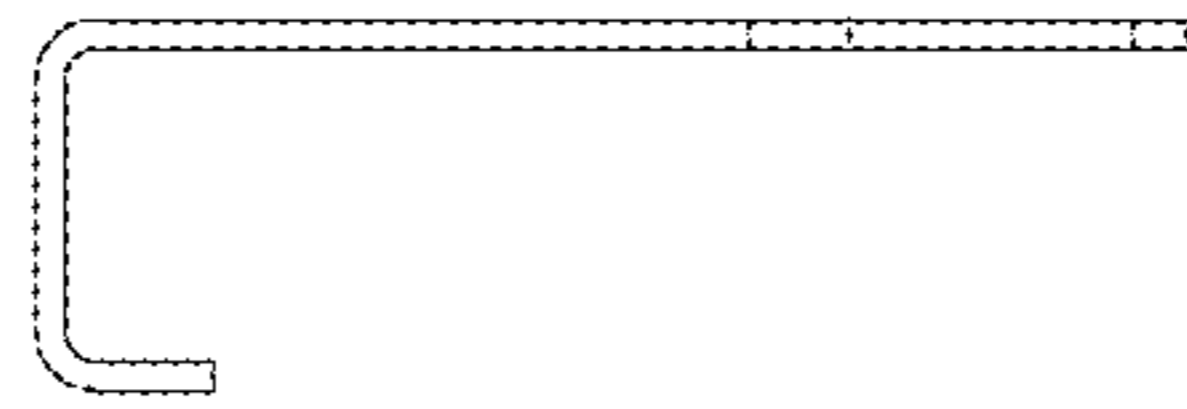

FIG. 6

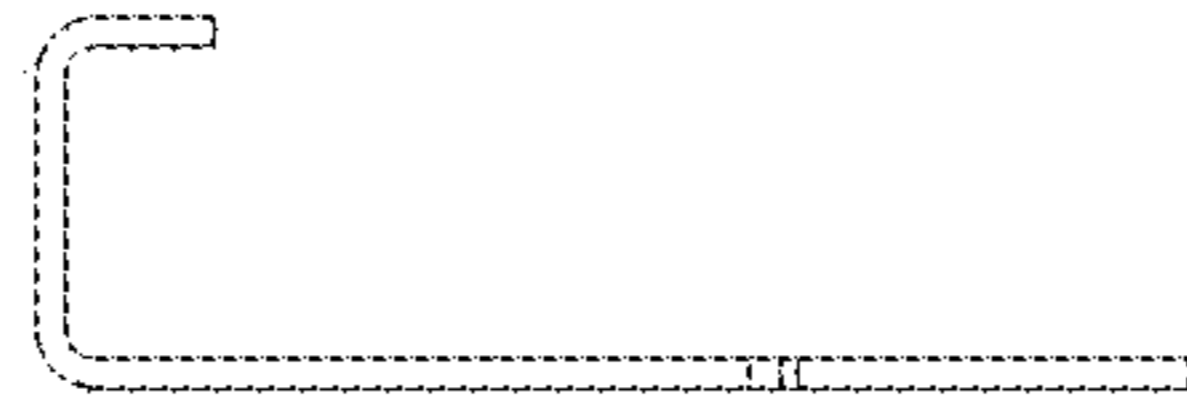

FIG. 7