



US00D983531S

(12) **United States Design Patent**  
**Lander**

(10) **Patent No.:** **US D983,531 S**  
(45) **Date of Patent:** **\*\* Apr. 18, 2023**

(54) **SINGLE-SIDED TOOTHBRUSH HEAD**

FOREIGN PATENT DOCUMENTS

(71) Applicant: **LANDER ENTERPRISES, LLC**, San Diego, CA (US)

CN 306765351 8/2021  
FR 3058314 A1 5/2018

(Continued)

(72) Inventor: **Christopher Lander**, San Diego, CA (US)

OTHER PUBLICATIONS

(73) Assignee: **LANDER ENTERPRISES, LLC**, San Diego, CA (US)

Ultrasonic Rechargeable Electric Toothbrush V-White 360° Automatic Toothbrush Whitening Electric Power Toothbrush for Adults, amazon.com, date unknown, 2 pages.

(\*\*) Term: **15 Years**

(Continued)

(21) Appl. No.: **29/842,751**

*Primary Examiner* — Cynthia Ramirez

(22) Filed: **Jun. 15, 2022**

*Assistant Examiner* — Tamara L Hahn

(74) *Attorney, Agent, or Firm* — David R. Heckadon; Gordon Rees Scully Mansukhani LLP

**Related U.S. Application Data**

(62) Division of application No. 29/764,231, filed on Dec. 29, 2020, now Pat. No. Des. 958,544.

(51) **LOC (14) Cl.** ..... **04-02**

(52) **U.S. Cl.**  
USPC ..... **D4/106**

(58) **Field of Classification Search**  
USPC ..... D4/100, 101, 104, 105, 106, 108, 113, D4/114; D24/176, 181; D29/108  
CPC ..... A63B 71/085; A46B 9/04; A46B 9/045; A46B 9/026; A46B 5/0095; A46B 7/04; A46B 7/06; A46B 2200/1066; A46B 2200/1086

See application file for complete search history.

(57) **CLAIM**

The ornamental design for a single-sided toothbrush head, as shown and described.

**DESCRIPTION**

FIG. 1 is a top perspective view of a single-sided toothbrush head.

FIG. 2 is a top plan view of the toothbrush head of FIG. 1. FIG. 3 is a bottom plan view of the toothbrush head of FIG. 1.

FIG. 4 is a right side elevation view of the toothbrush head of FIG. 1.

FIG. 5 is a left side elevation view of the toothbrush head of FIG. 1.

FIG. 6 is a top plan view of the toothbrush head of FIG. 1; and,

FIG. 7 is a bottom plan view of the toothbrush head of FIG. 1.

The broken lines shown in the drawings depict portions of the single-sided toothbrush head that form no part of the claimed design.

(56) **References Cited**

U.S. PATENT DOCUMENTS

5,259,086 A 11/1993 Fong  
D406,891 S 3/1999 Smith  
6,083,235 A 7/2000 Wagner  
6,202,245 B1 3/2001 Khodadadi  
D460,268 S 7/2002 Harada

(Continued)

**1 Claim, 7 Drawing Sheets**

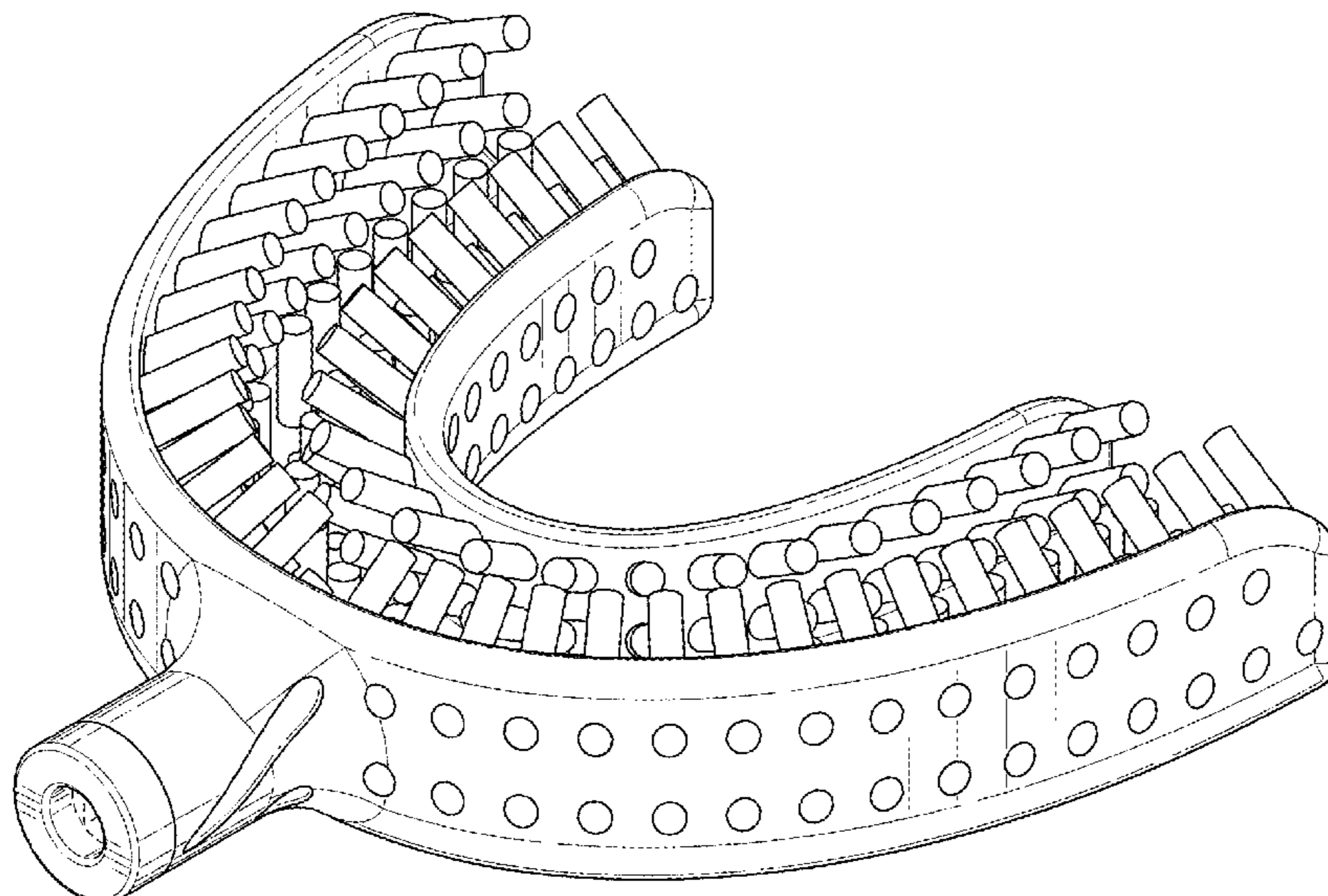

(56)

References Cited

U.S. PATENT DOCUMENTS

D461,057 S 8/2002 Flores et al.  
 D465,847 S 11/2002 Jacobs  
 7,418,757 B2 9/2008 Gatznerneyer et al.  
 D623,414 S 9/2010 Wagner  
 D652,575 S \* 1/2012 Farrell ..... D29/108  
 D652,576 S \* 1/2012 Farrell ..... D29/108  
 8,206,201 B2 6/2012 Fioratti  
 D756,121 S 5/2016 Gruber et al.  
 D764,061 S \* 8/2016 Furdui-Carr ..... D24/176  
 D764,664 S 8/2016 Ripich et al.  
 D781,427 S 3/2017 Blank et al.  
 D782,743 S \* 3/2017 Engel ..... D29/108  
 D787,674 S 5/2017 Sosa et al.  
 D795,440 S 8/2017 Way et al.  
 D800,315 S \* 10/2017 Crowley ..... D24/176  
 D813,390 S 3/2018 Austria  
 9,907,633 B2 3/2018 Wolpo  
 10,314,679 B2 6/2019 Blank et al.  
 D853,655 S \* 7/2019 Turkbaz ..... D29/108  
 10,368,968 B2 8/2019 Reizenon  
 D864,578 S 10/2019 Liu  
 D867,598 S 11/2019 Qin et al.  
 D883,678 S \* 5/2020 Xin ..... D24/152  
 D885,768 S 6/2020 Li  
 D887,146 S 6/2020 Lander  
 D893,197 S 8/2020 Rosenberg  
 D899,600 S 10/2020 Li  
 D904,620 S 12/2020 Farrell  
 D908,890 S 1/2021 Demarest et al.  
 D943,282 S 2/2022 Lander  
 D951,649 S \* 5/2022 Chen ..... D4/101  
 D951,652 S \* 5/2022 Lander ..... D4/106  
 D958,544 S \* 7/2022 Lander ..... D4/106  
 2009/0276972 A1 \* 11/2009 Dugan ..... A61C 17/349  
 15/167.2  
 2015/0282910 A1 \* 10/2015 Furdui-Carr ..... A46B 9/045  
 15/22.1  
 2017/0025137 A1 1/2017 Shi et al.

2017/0120135 A1 \* 5/2017 Engel ..... A63B 71/085  
 2018/0242727 A1 8/2018 Ofek et al.  
 2020/0093251 A1 3/2020 Song et al.  
 2020/0253368 A1 8/2020 Laurent et al.  
 2021/0161287 A1 6/2021 Cadot et al.

FOREIGN PATENT DOCUMENTS

FR 3058315 B1 1/2019  
 GB 6106472 11/2020  
 GB 6142182 6/2021  
 GB 6177578 11/2021  
 GB 6177579 11/2021  
 WO 2018087481 A1 5/2018  
 WO 2021023921 A1 2/2021

OTHER PUBLICATIONS

U-Shape Automatic Sonic Electric Toothbrush, excelvan.com, date unknown, 5 pages.  
 Automatic Whitening Toothbrush; inspireuplift.com, date unknown, 6 pages.  
 Azdent 360 Intelligent Sonic Electric Automatic Toothbrush, aliexpress.com, 2020, 31 pages.  
 Dental Automatic Electric Wireless 360 Children Toothbrush/Teeth Clean Head, ebay.com, 2020, 8 pages.  
 Autobrush Pro Adults Complete Oral Healthcare System, amazon.com, 2021, 11 pages.  
 Autobrush Pro Kids, tryautobrush.com, 2021, 4 pages.  
 Autobrush 4 Kids Whole Mouth Electric Toothbrush, walmart.com, 2020, 10 pages.  
 Autobrush Automatic Tongue Scraper, tryautobrush.com, 2020, 5 pages.  
 Autobrush for Adults Replenish Pack, youtube.com, Jul. 29, 2020, 2 pages.  
 Autobrush Extra Brush Head, tryautobrush.com, 2021, 3 pages.  
 V-White U-Shaped Replacement Head for Ultrasonic Toothbrush, amazon.com, June of 2019, 7 pages.

\* cited by examiner

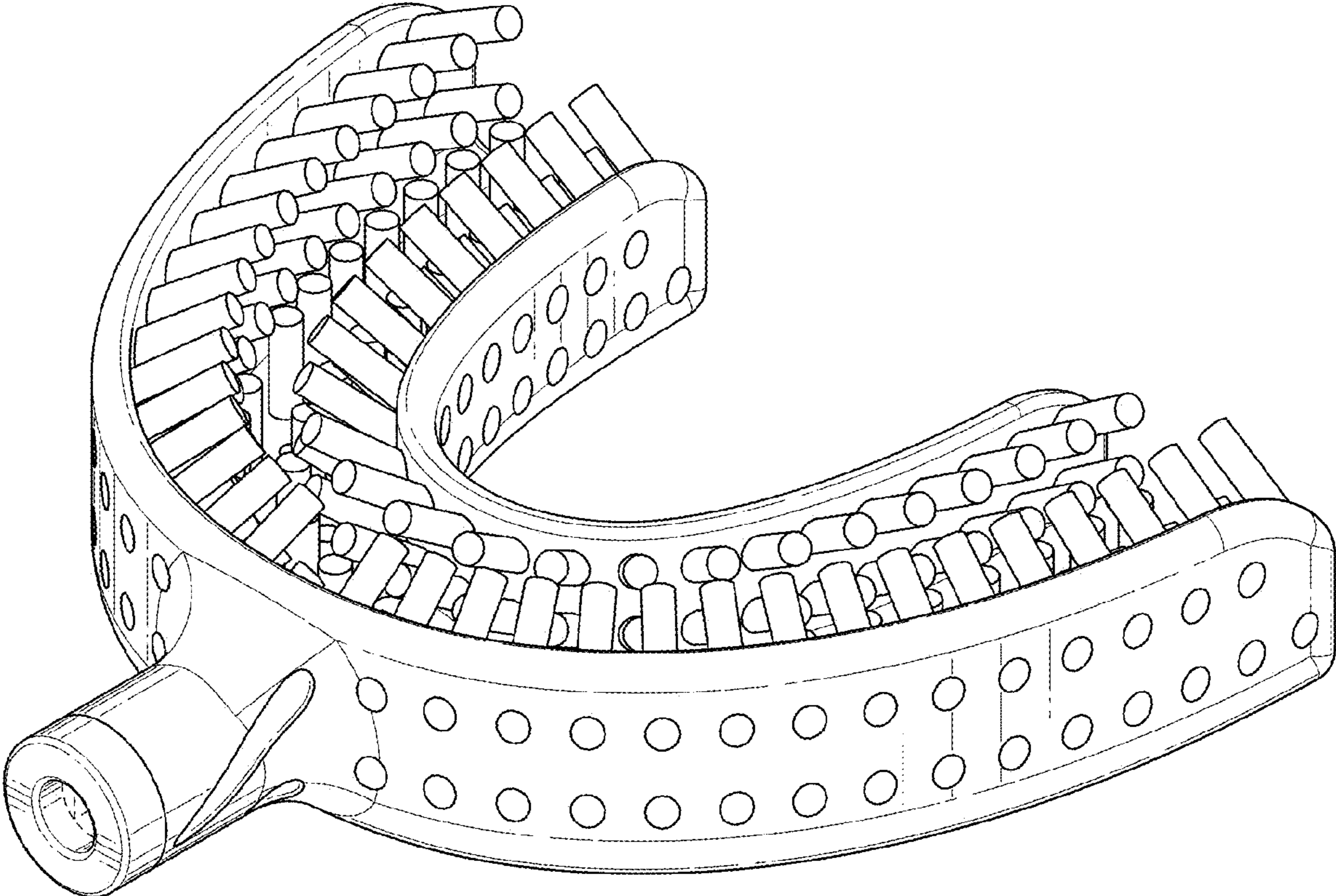

FIG. 1

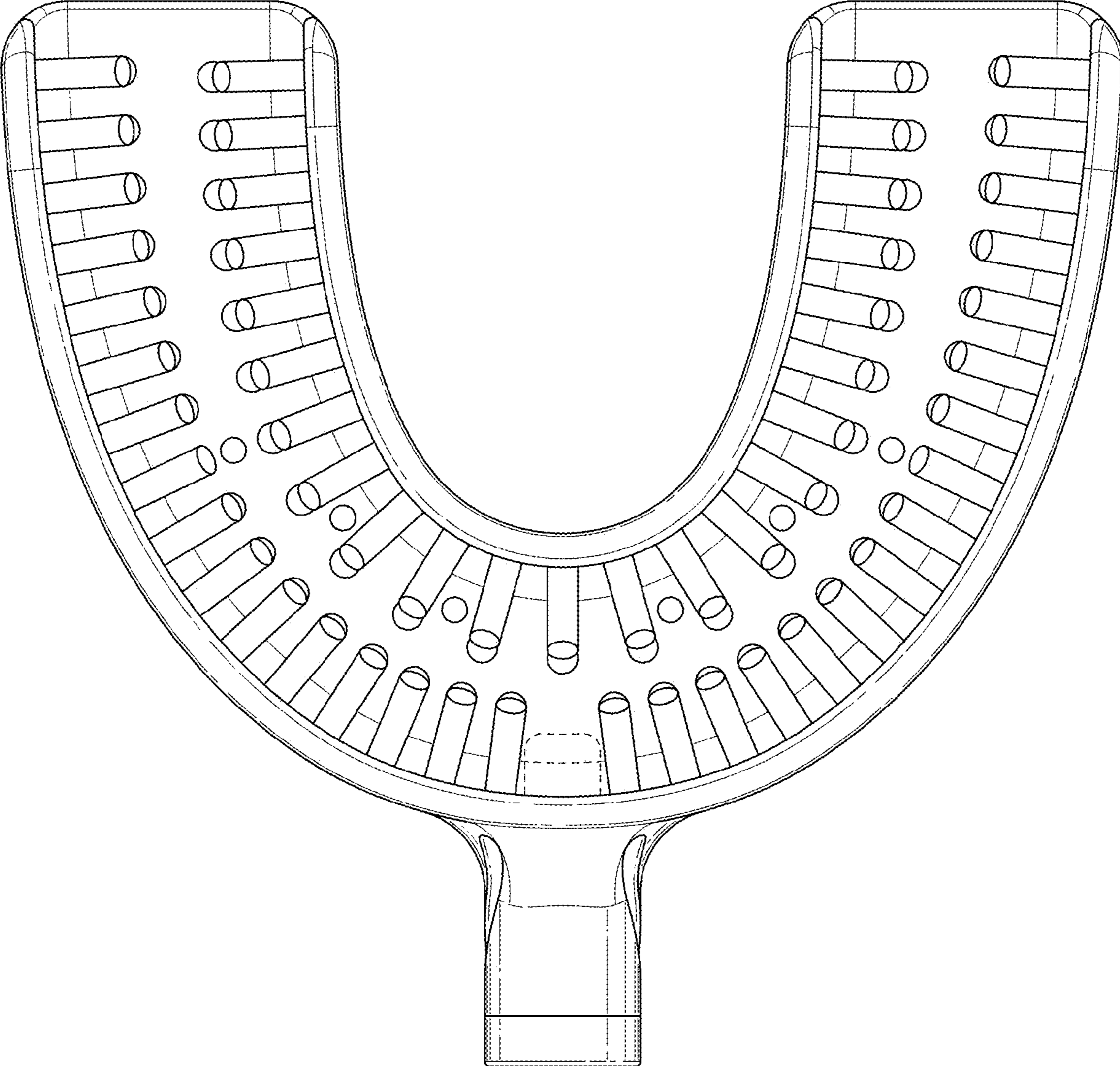

FIG. 2

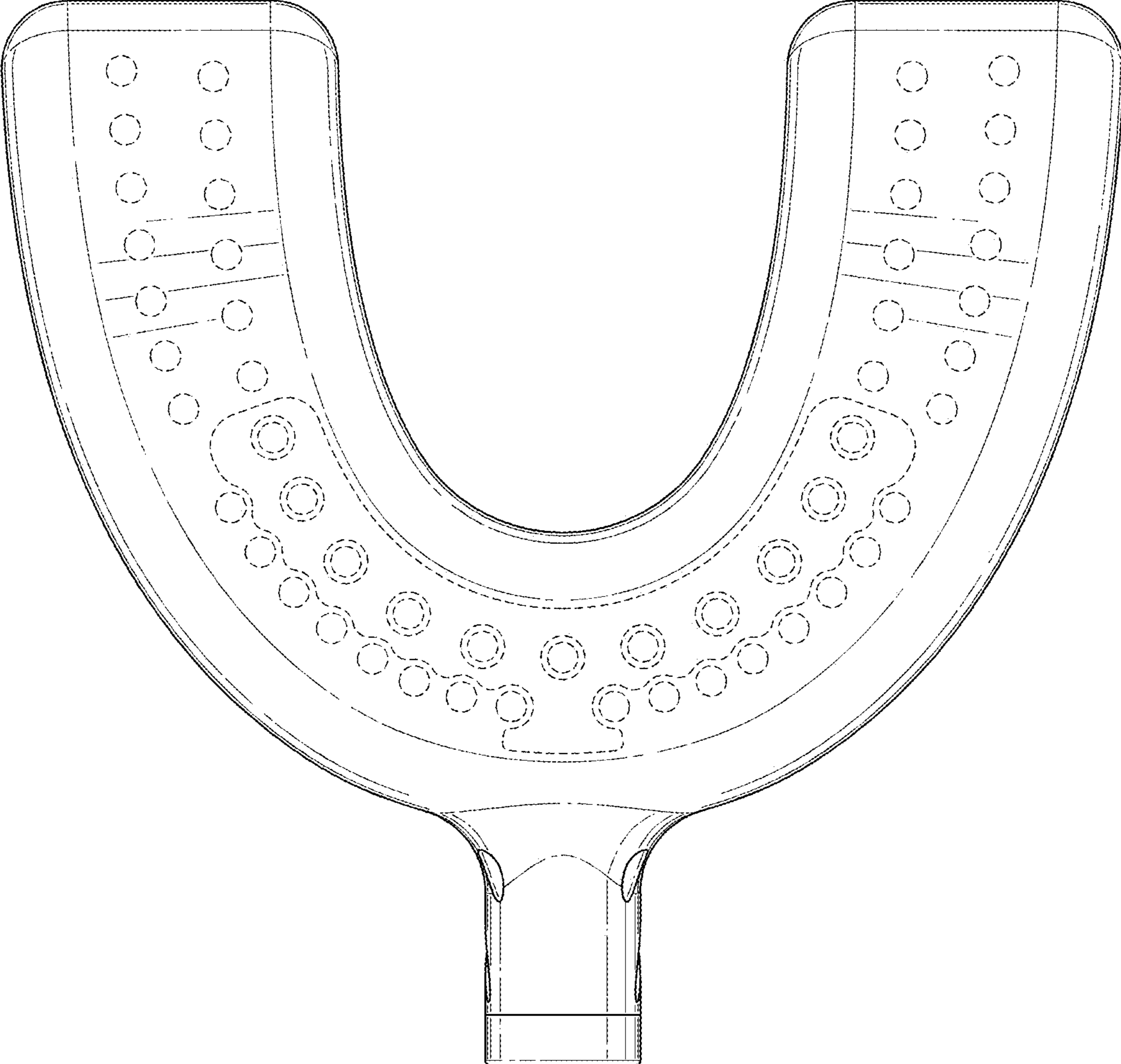

FIG. 3

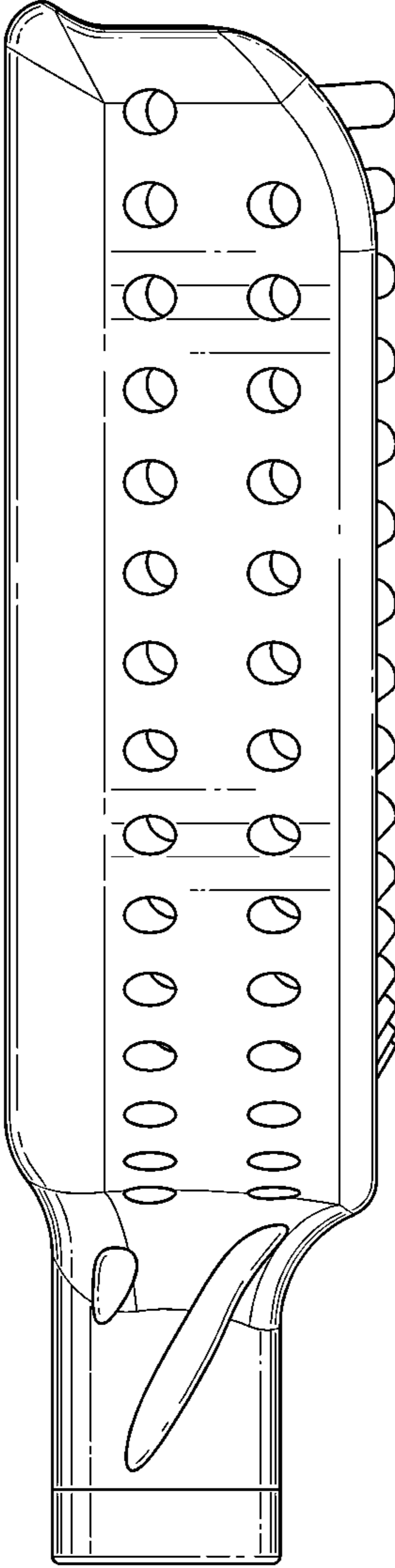

FIG. 4

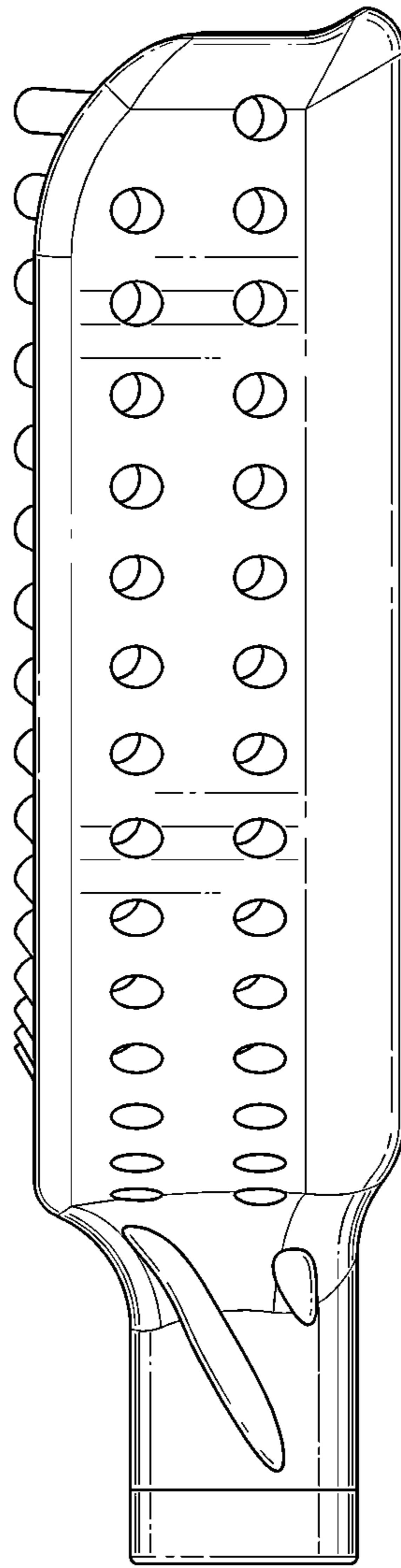

FIG. 5

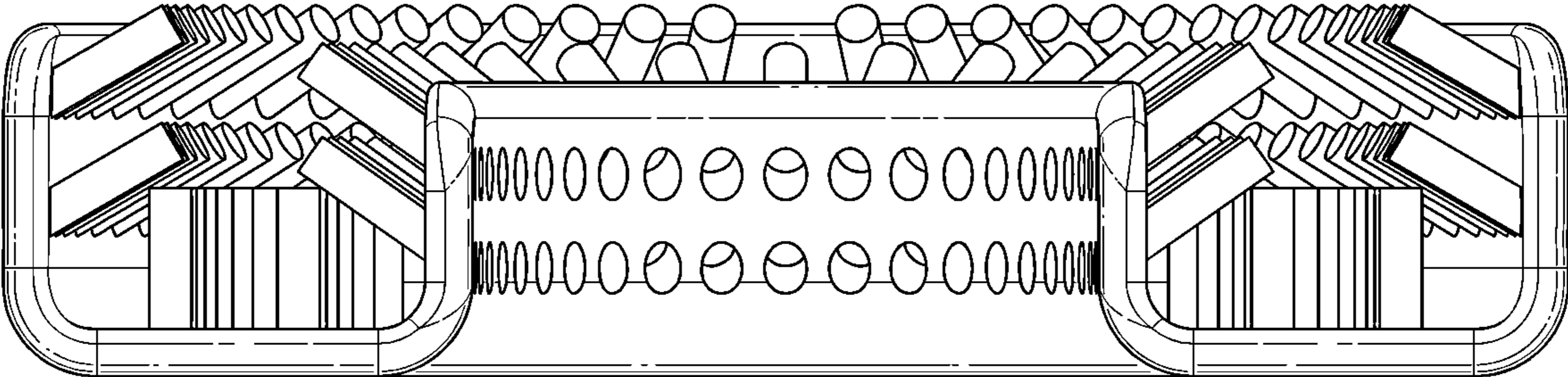

FIG. 6



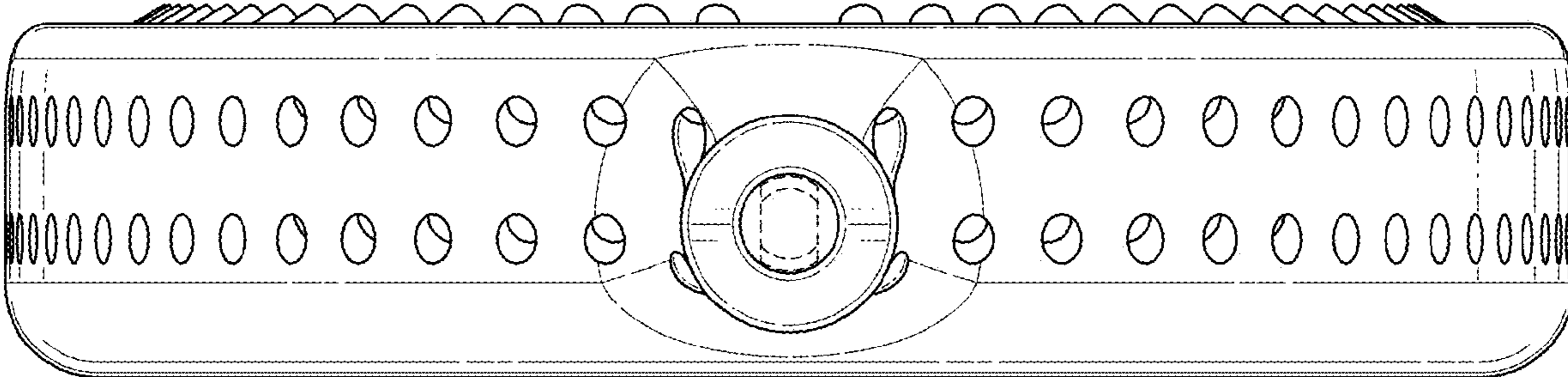

FIG. 7