



US00D983478S

(12) **United States Design Patent** (10) **Patent No.:** **US D983,478 S**
Rogers (45) **Date of Patent:** **** Apr. 18, 2023**

- (54) **ANIMAL FEED BLOCK** 5,267,863 A * 12/1993 Simmons, Jr. A63F 9/0613
434/96
- (71) Applicant: **Michael A. K. Rogers**, Stephenville, TX (US) 5,826,873 A * 10/1998 Lavermicocca B26F 3/12
273/157 R
- (72) Inventor: **Michael A. K. Rogers**, Stephenville, TX (US) D407,765 S * 4/1999 Zheng D21/491
7,648,407 B1 * 1/2010 Sorensen A63H 33/084
446/124
- (**) Term: **15 Years** D802,058 S * 11/2017 Ishaque D21/501
D828,458 S * 9/2018 Dumphy D21/500
D832,937 S * 11/2018 Dumphy D21/500
D855,930 S * 8/2019 Barson D1/100
- (21) Appl. No.: **29/739,518** 10,456,702 B2 * 10/2019 Dumphy A63H 33/084
D963,061 S * 9/2022 Ling D21/489
- (22) Filed: **Jun. 25, 2020** 2017/0203226 A1 * 7/2017 Dorasamy A63H 33/086

* cited by examiner

Related U.S. Application Data

- (63) Continuation of application No. 29/726,751, filed on Mar. 5, 2020, now Pat. No. Des. 900,199, and a continuation-in-part of application No. 16/656,547, filed on Oct. 17, 2019, now abandoned.

- (51) **LOC (14) Cl.** **01-01**
- (52) **U.S. Cl.**
USPC **D1/100**

- (58) **Field of Classification Search**
USPC D1/100-130, 199; 426/104, 108, 138, 426/391, 549, 808, 94, 143, 559, 560; D24/101-104; D28/8.1, 63; D6/601; D32/40, 43; D9/707, 756; D30/160; D18/56; D25/113, 115; D23/366
CPC A23G 3/50; A23G 3/54; A23J 3/26; A23L 1/0067; B41J 2/17593
See application file for complete search history.

(56) **References Cited**

U.S. PATENT DOCUMENTS

- D203,436 S * 1/1966 Conway D1/100
- D285,585 S * 9/1986 Murdough, Jr. D21/491

Primary Examiner — Katie Jane Stofko

(74) *Attorney, Agent, or Firm* — The Compton Law Firm, P.C.; Scott D. Compton

(57) **CLAIM**

The ornamental design for an animal feed block, as shown and described.

DESCRIPTION

FIG. 1 is a top perspective view of an animal feed block showing my new design;
 FIG. 2 is a front elevational view thereof;
 FIG. 3 is a rear elevational view thereof;
 FIG. 4 is a left side elevational view thereof;
 FIG. 5 is a right side elevational view thereof;
 FIG. 6 is a bottom plan view thereof;
 FIG. 7 is a top plan view thereof; and,
 FIG. 8 is another top perspective view thereof, shown in an environment of use.
 The broken lines in FIG. 8 illustrate environmental features that form no part of the claimed design.

1 Claim, 5 Drawing Sheets

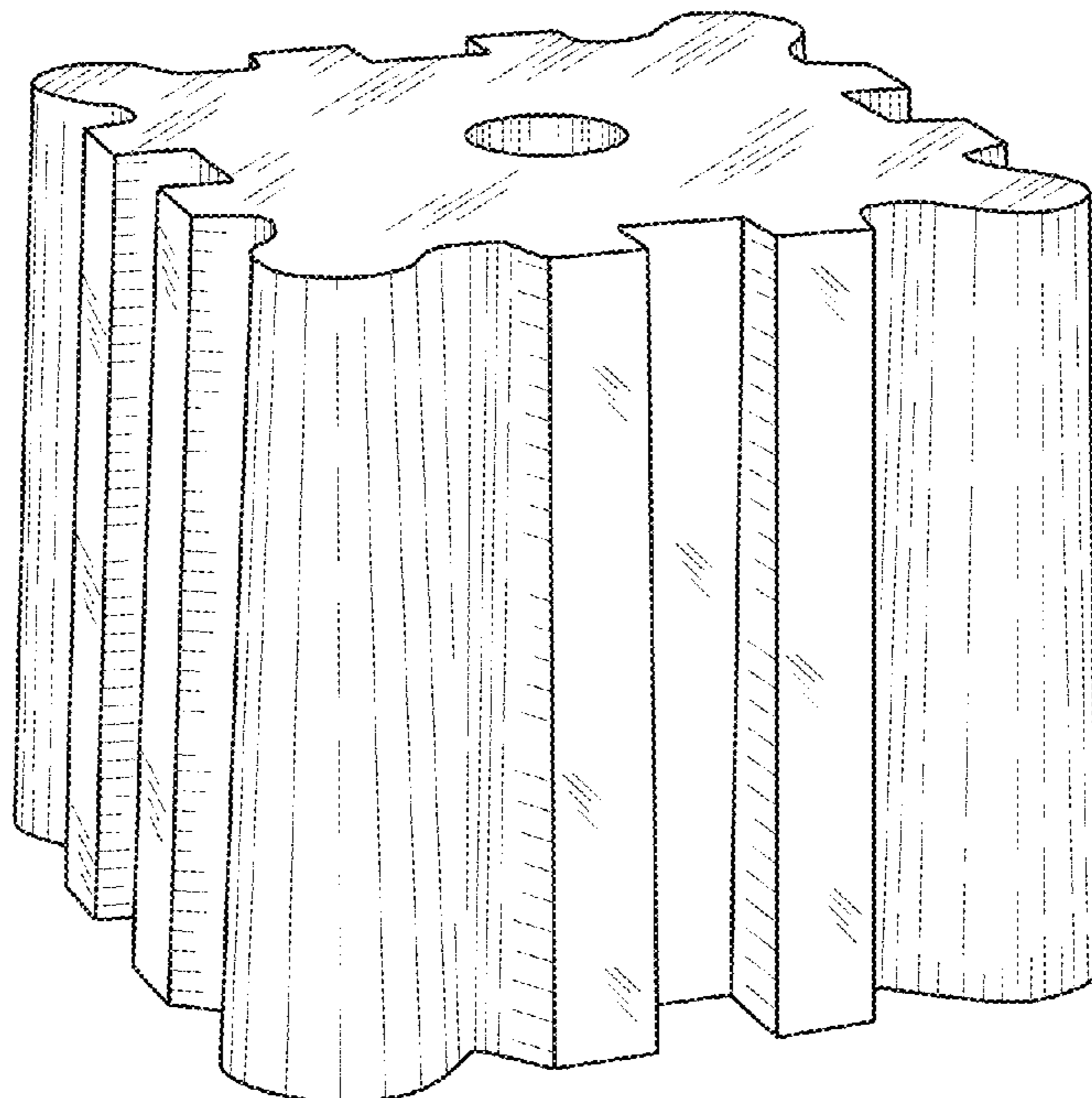

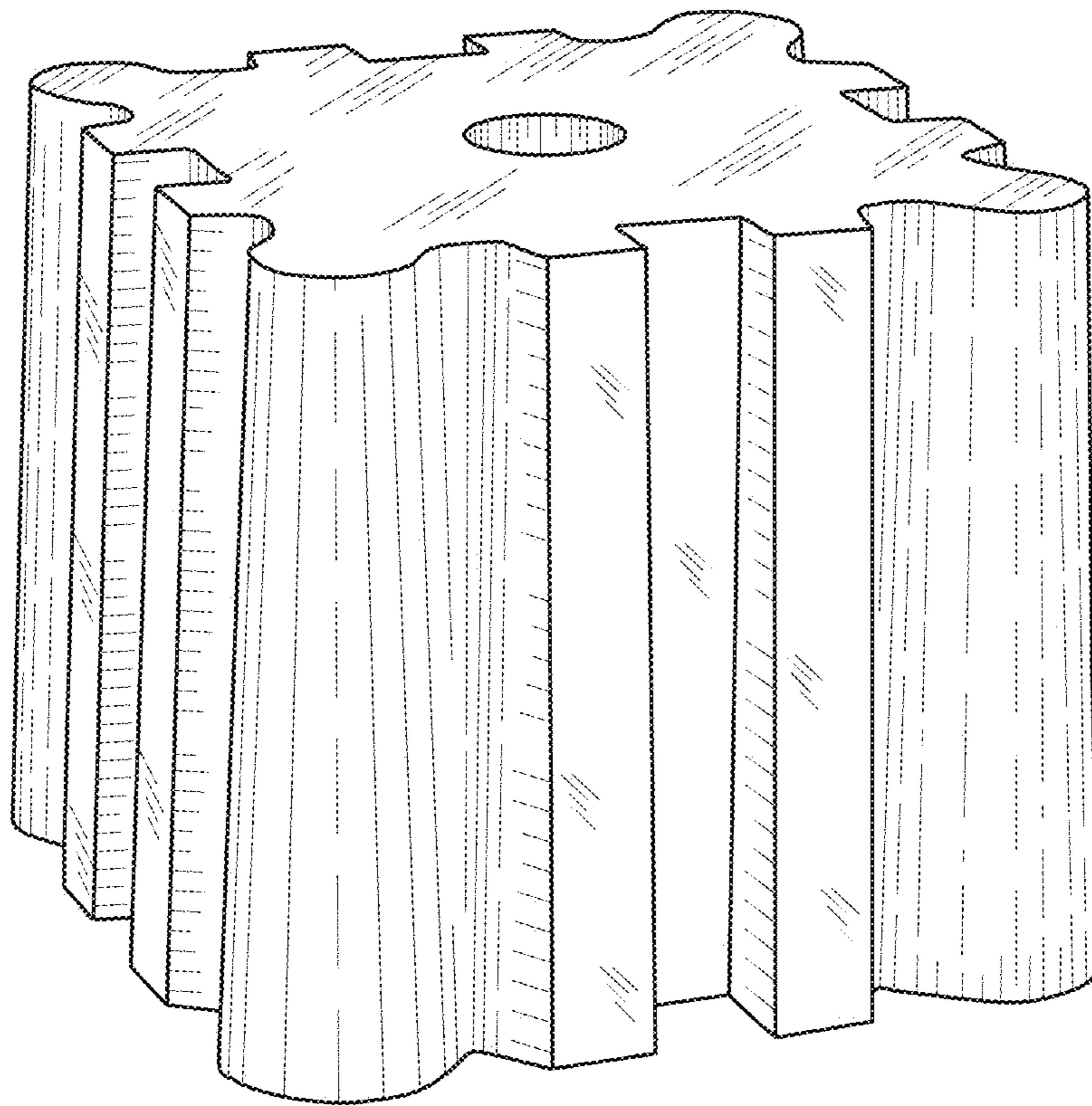

FIG. 1

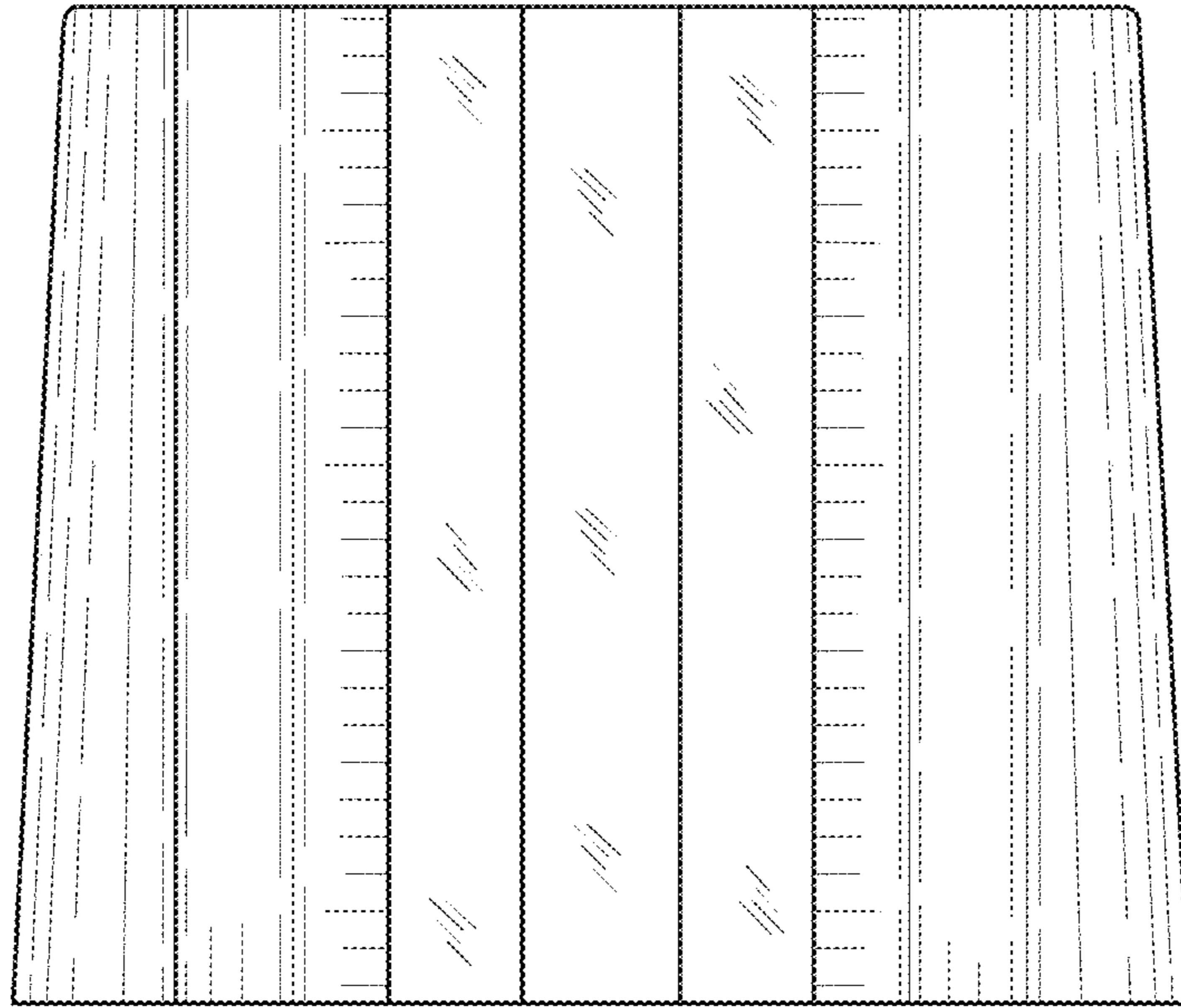

FIG. 2

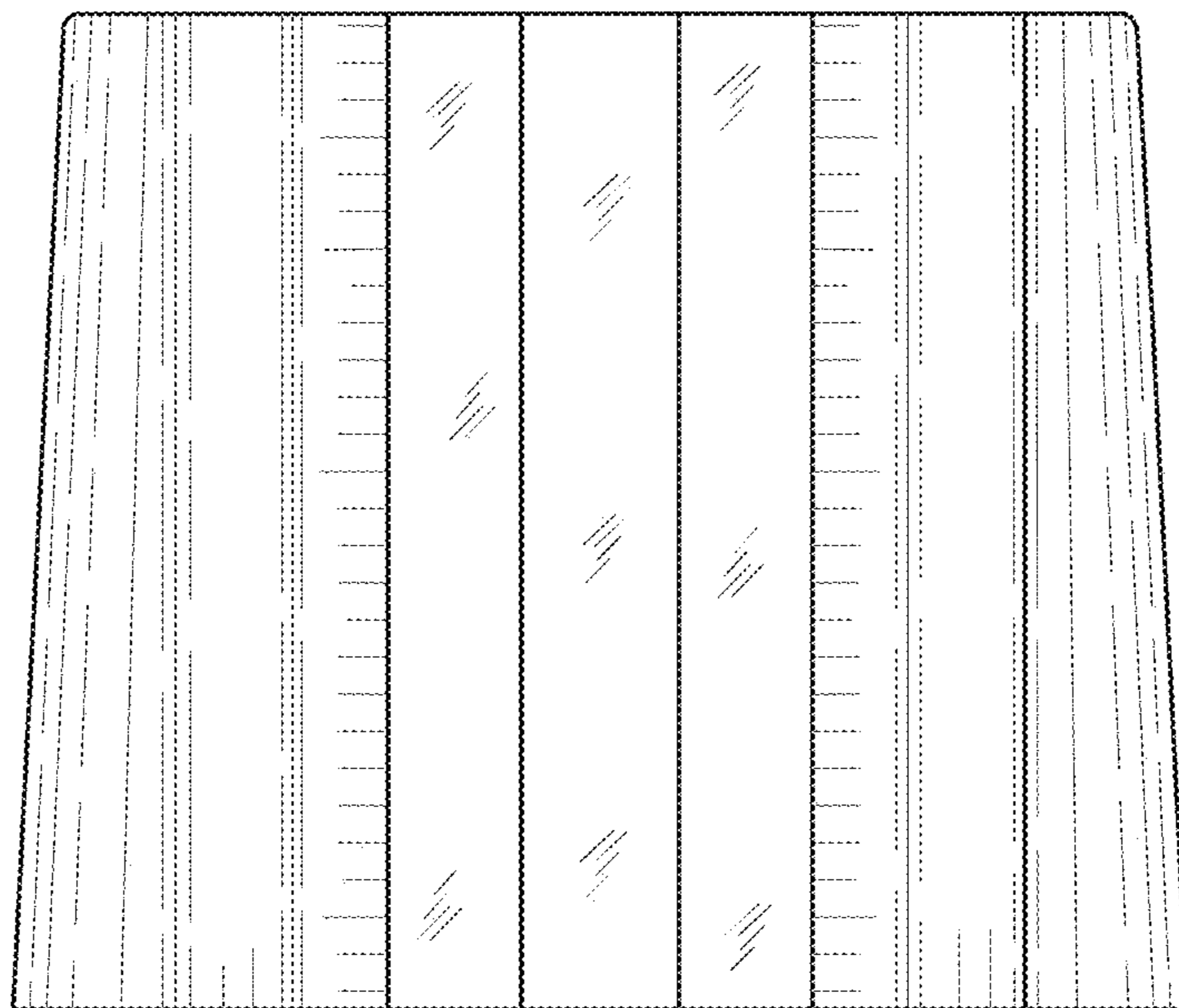

FIG. 3

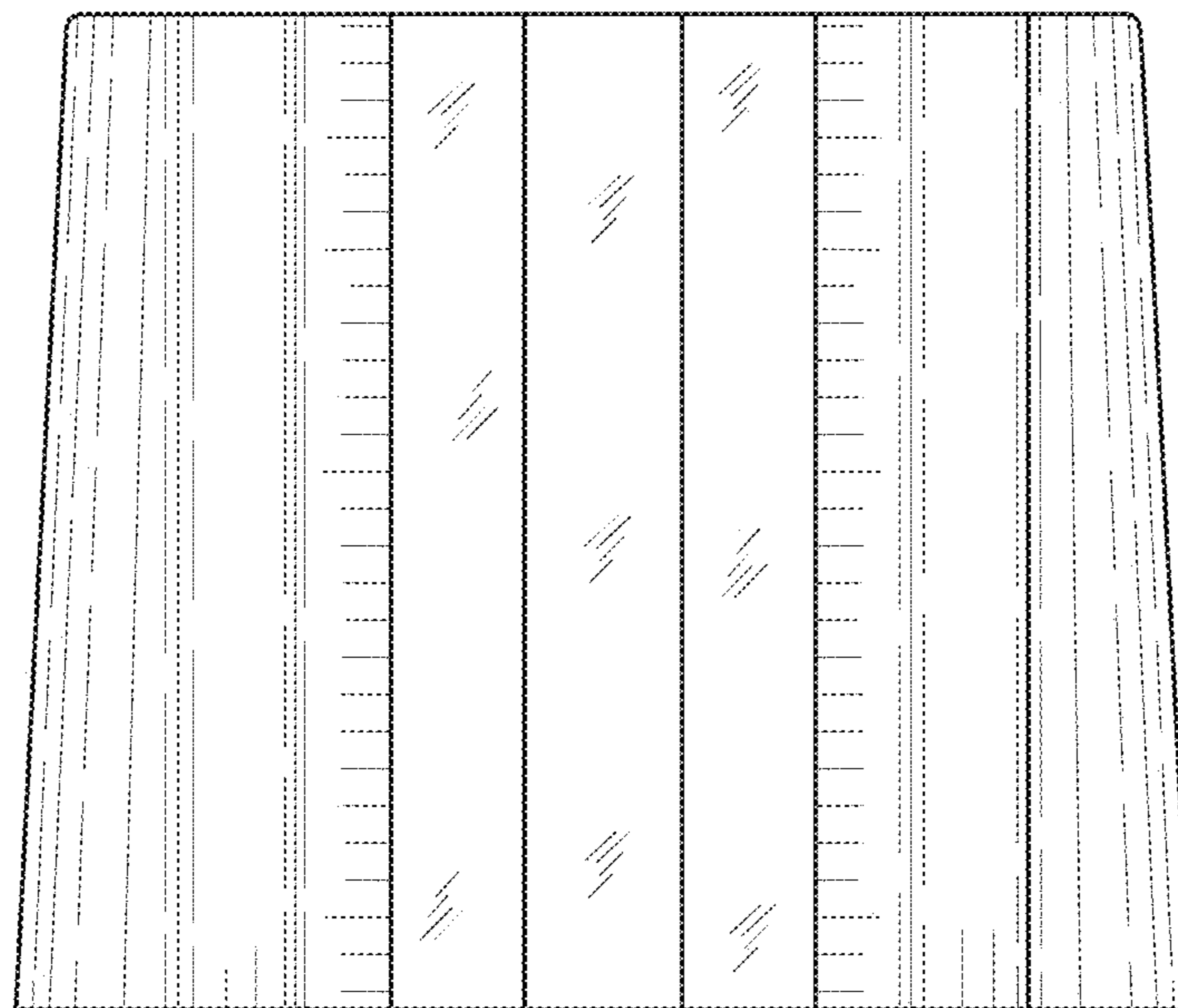

FIG. 4

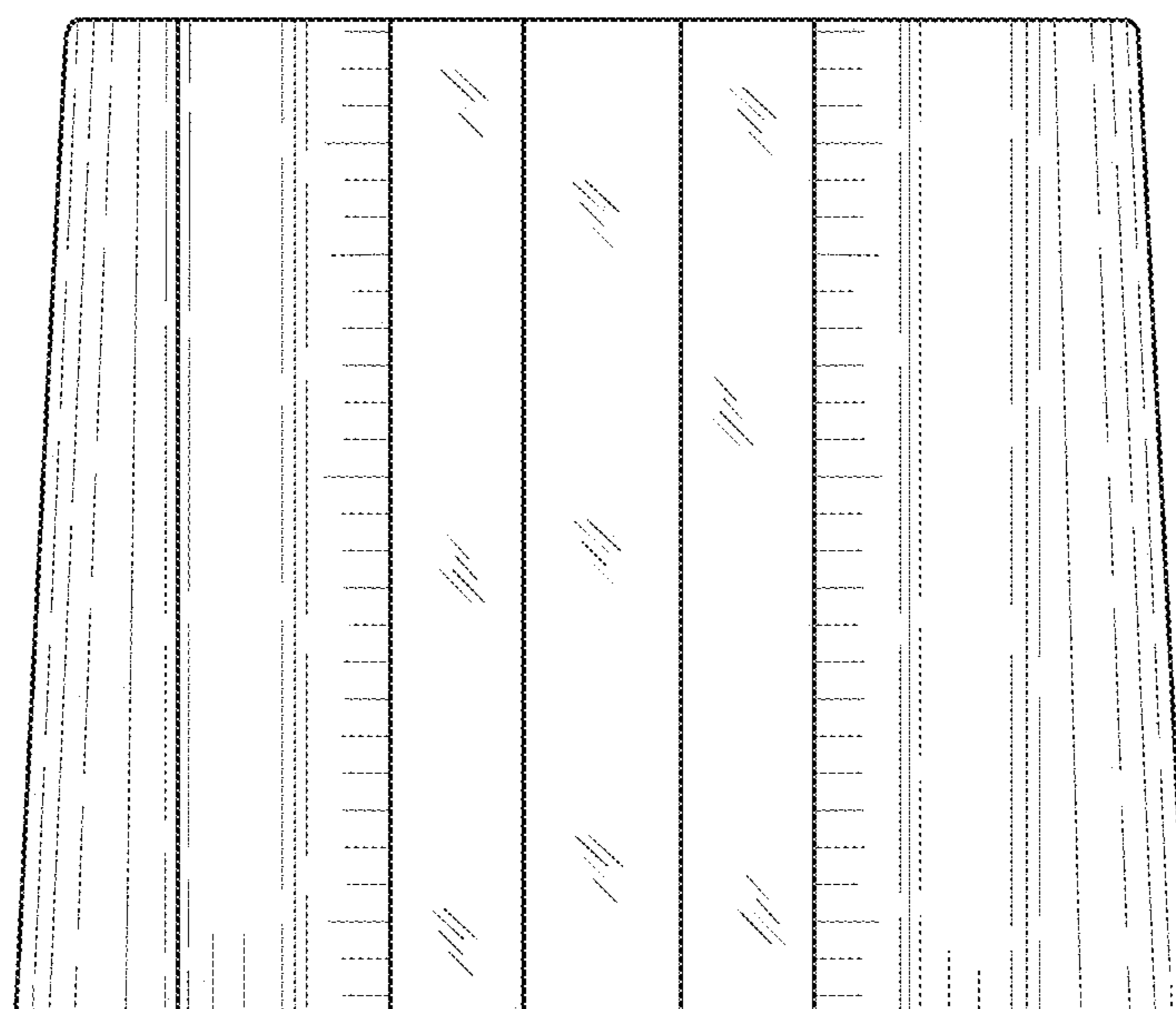

FIG. 5

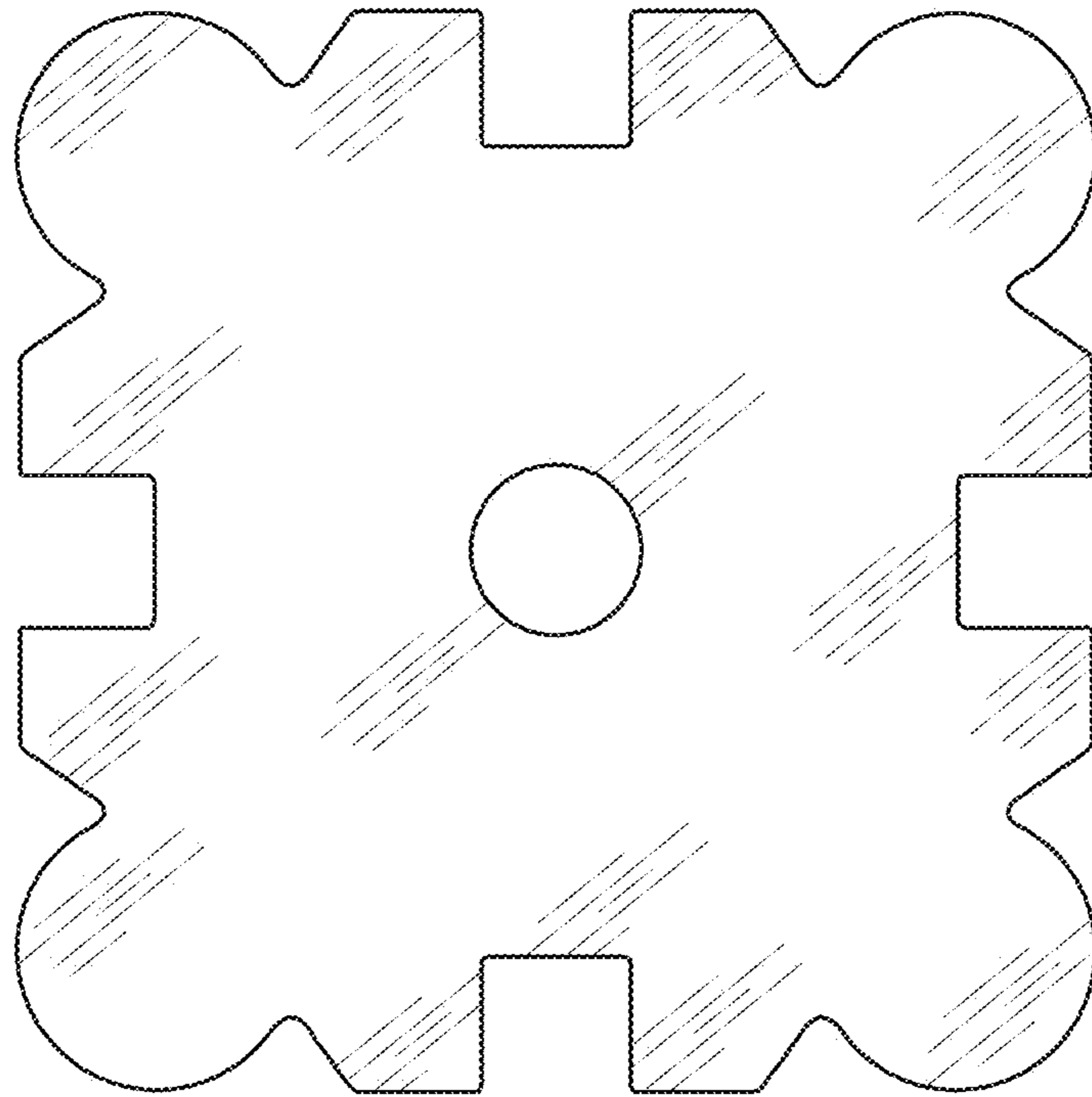

FIG. 6

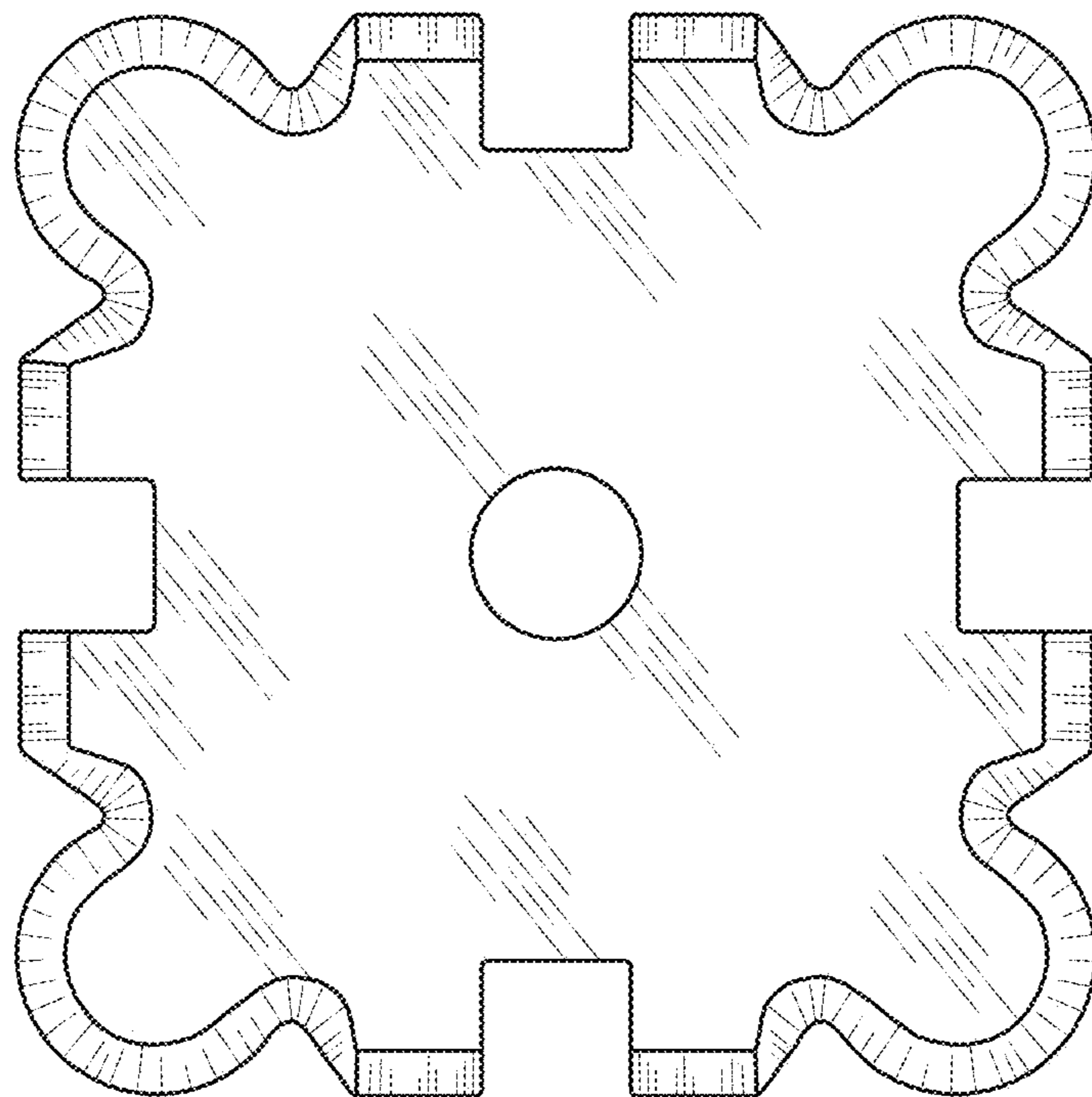

FIG. 7

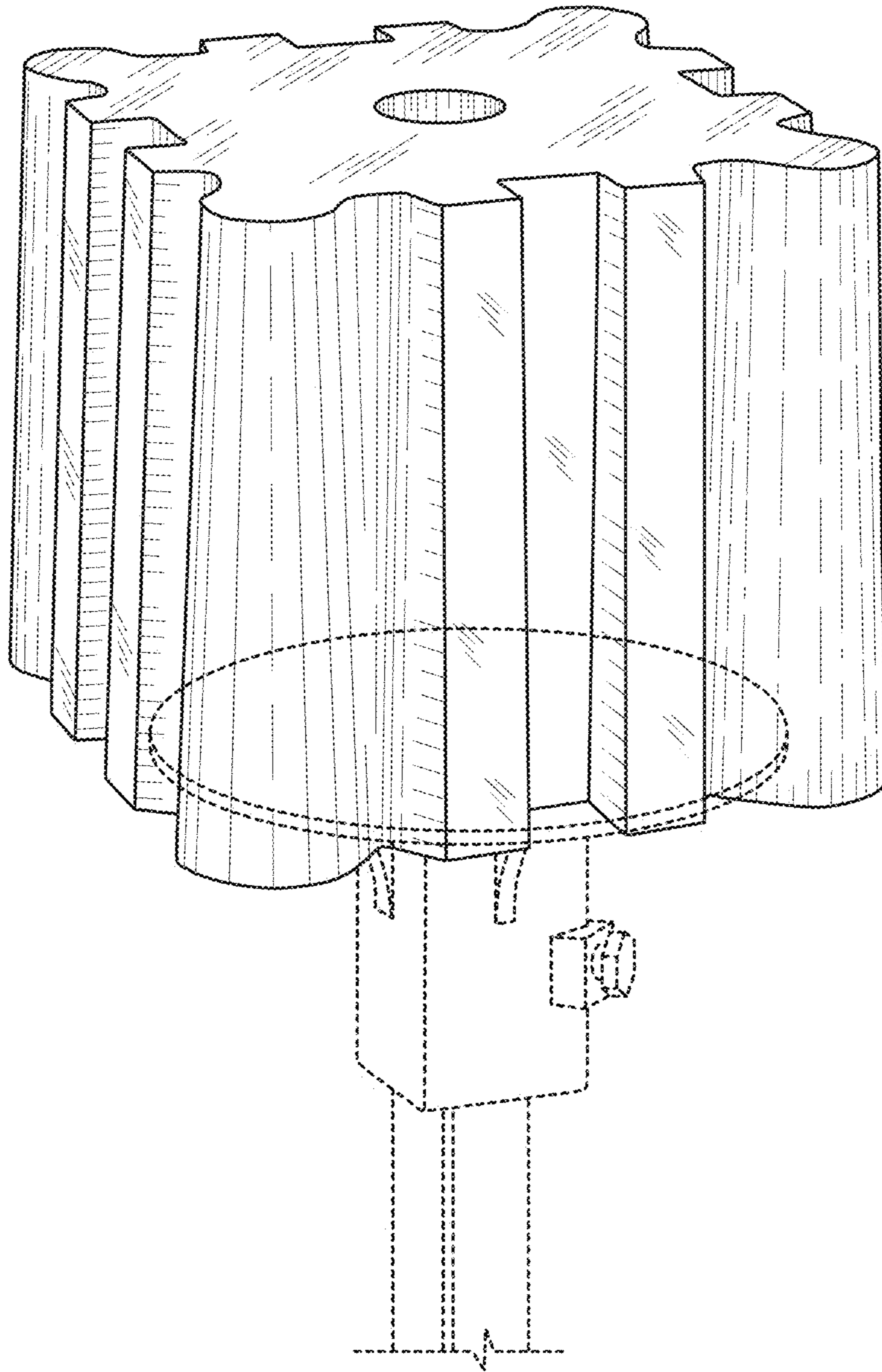

FIG. 8