



US00D983446S

(12) **United States Design Patent**
Rechenmann

(10) **Patent No.:** **US D983,446 S**

(45) **Date of Patent:** **** Apr. 11, 2023**

(54) **COSMETICS APPLICATOR**

(71) Applicant: **COSMOGEN SAS**, Paris (FR)

(72) Inventor: **Justine Rechenmann**, Paris (FR)

(73) Assignee: **Cosmogen SAS**, Paris (FR)

(**) Term: **15 Years**

(21) Appl. No.: **29/765,532**

(22) Filed: **Jan. 8, 2021**

(30) **Foreign Application Priority Data**

Jul. 8, 2020 (EM) 008 035 737-0002

(51) **LOC (14) Cl.** **28-03**

(52) **U.S. Cl.**
USPC **D28/7**

(58) **Field of Classification Search**
USPC D28/4, 7, 9, 20, 57, 76, 85; D19/36;
D24/119

CPC A45D 29/16; A45D 2200/00; A45D
2200/10; A45D 2200/1072

See application file for complete search history.

(56) **References Cited**

U.S. PATENT DOCUMENTS

D307,331 S * 4/1990 Pflieger D28/7
D387,629 S * 12/1997 Thierry D7/688

D490,932 S * 6/2004 Mammone D28/7
D516,392 S * 3/2006 de Vries D7/688
D587,075 S * 2/2009 Dibnah D28/7
D654,216 S * 2/2012 Best D28/7
D785,238 S * 4/2017 Silva D28/7
D812,295 S * 3/2018 Staab D28/7
D852,413 S * 6/2019 Staab D28/7

* cited by examiner

Primary Examiner — Zenia I Bennett

(74) *Attorney, Agent, or Firm* — Burriss Law, PLLC

(57) **CLAIM**

The ornamental design for a cosmetics applicator, as shown and described.

DESCRIPTION

FIG. 1 is a perspective view of the cosmetics applicator;
FIG. 2 is a top view thereof;
FIG. 3 is a bottom view thereof;
FIG. 4 is a front view thereof;
FIG. 5 is a rear view thereof;
FIG. 6 is a right side view thereof; and,
FIG. 7 is a left side view thereof.

1 Claim, 7 Drawing Sheets

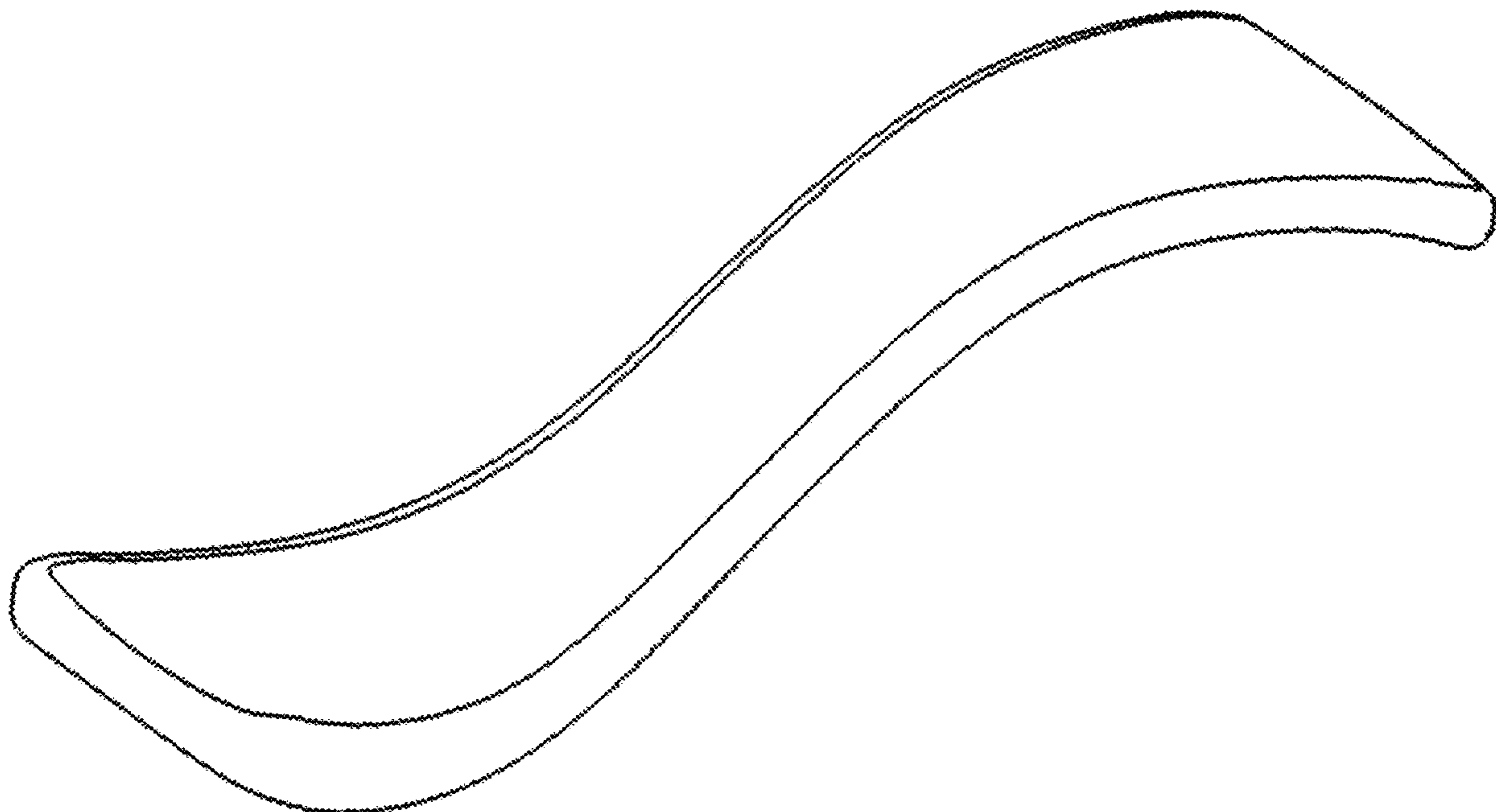

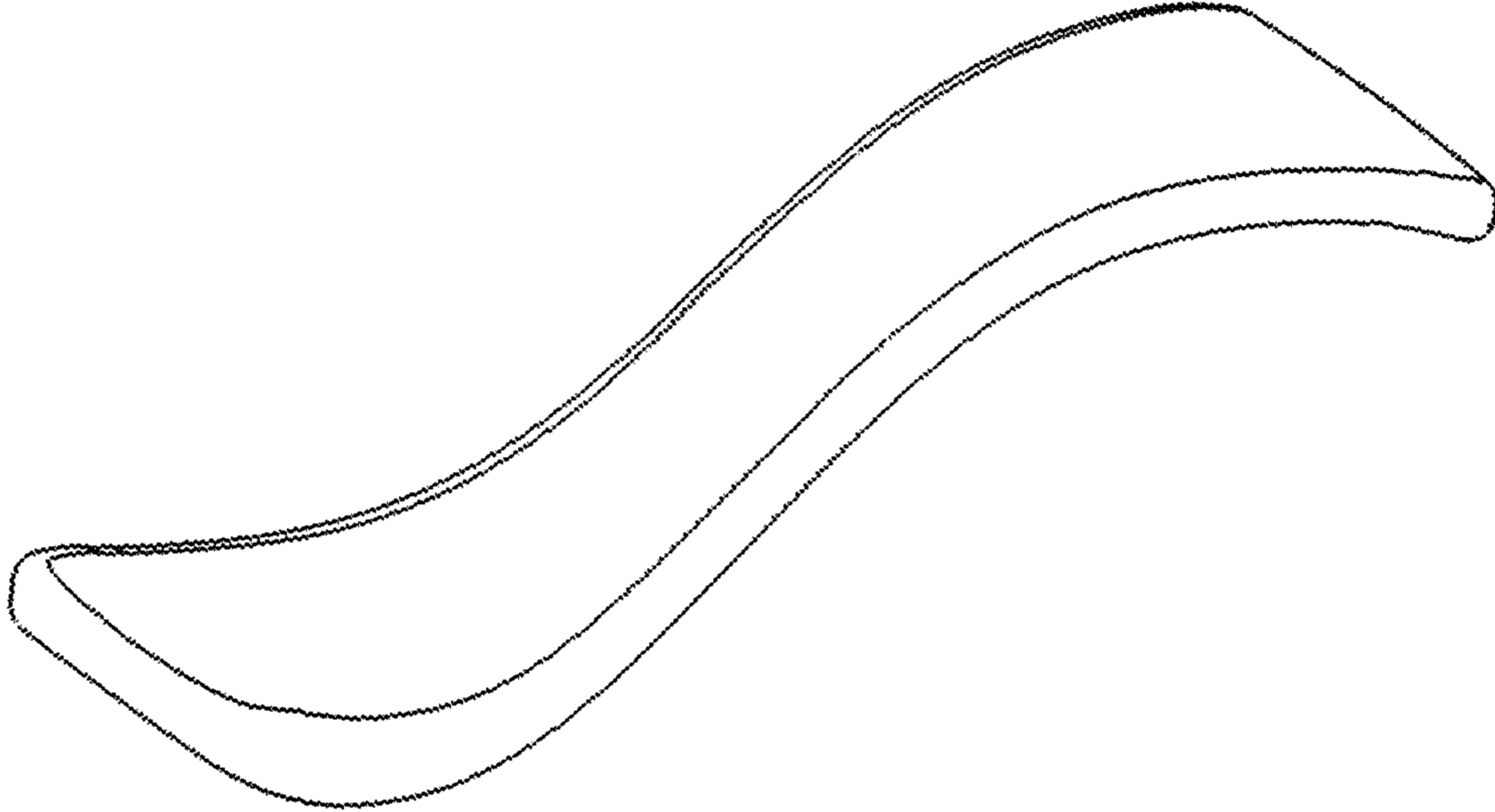

FIG. 1

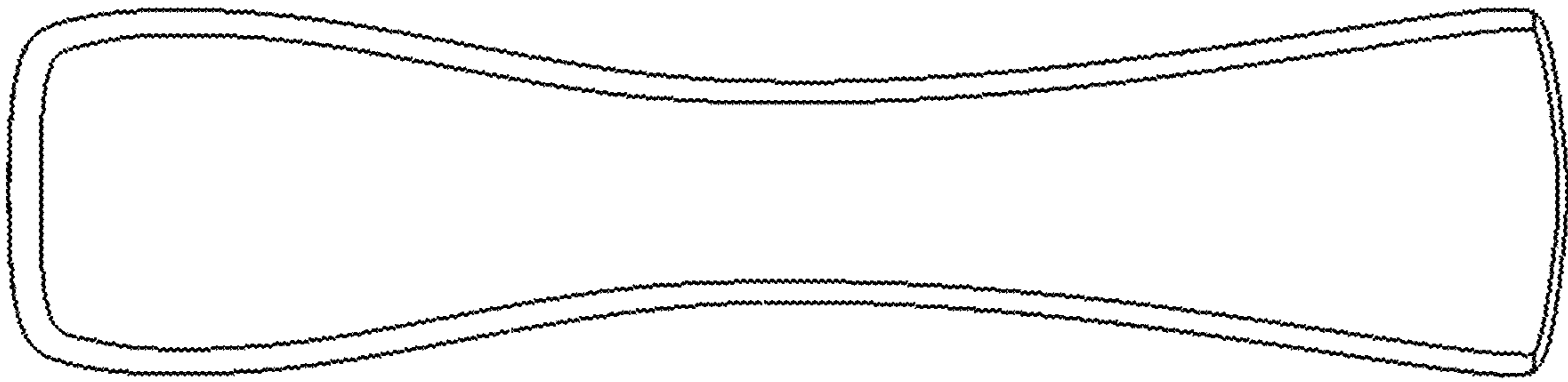

FIG. 2

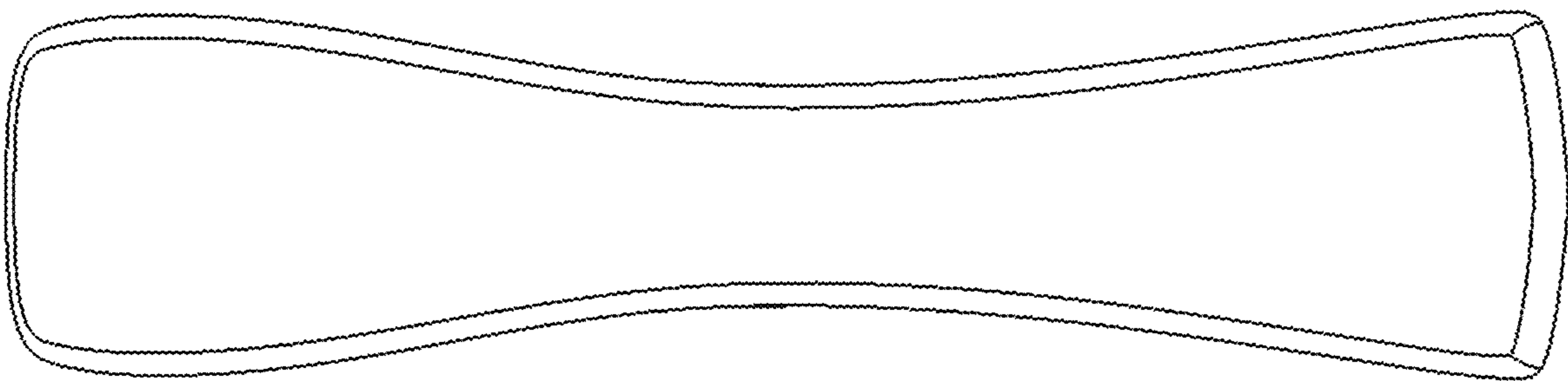

FIG. 3

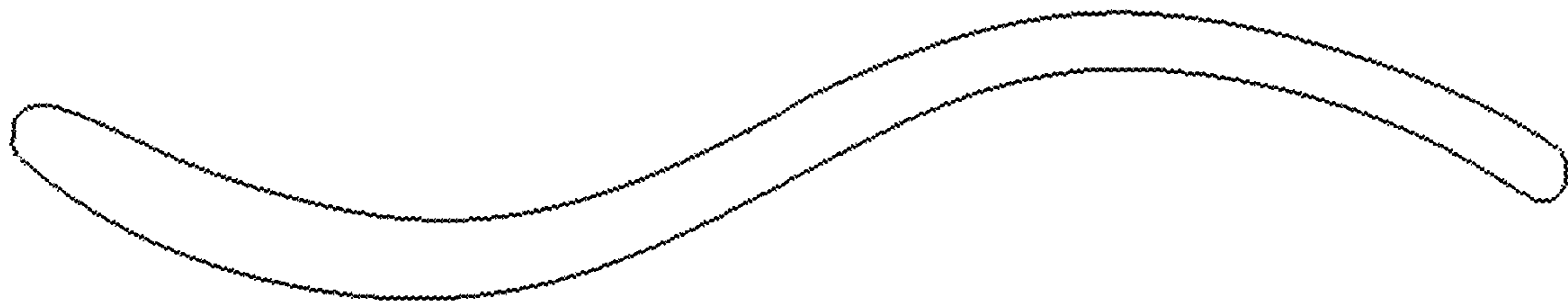

FIG. 4

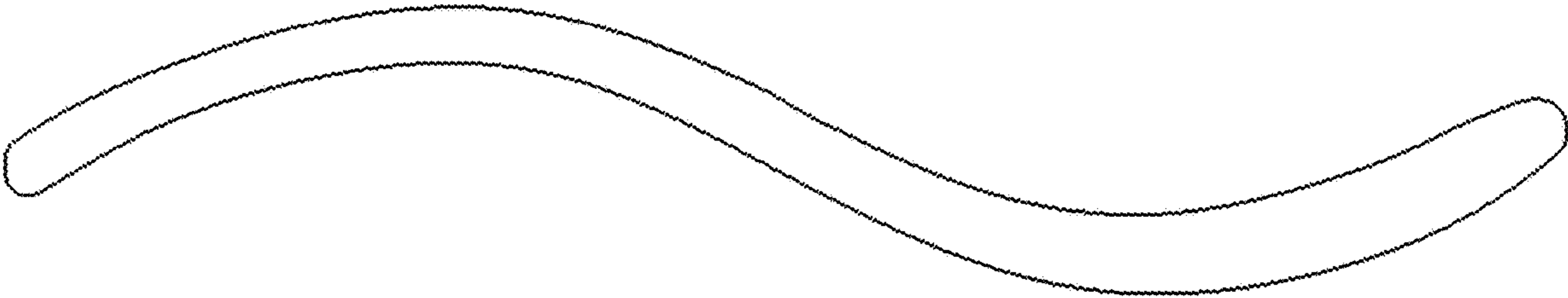

FIG. 5

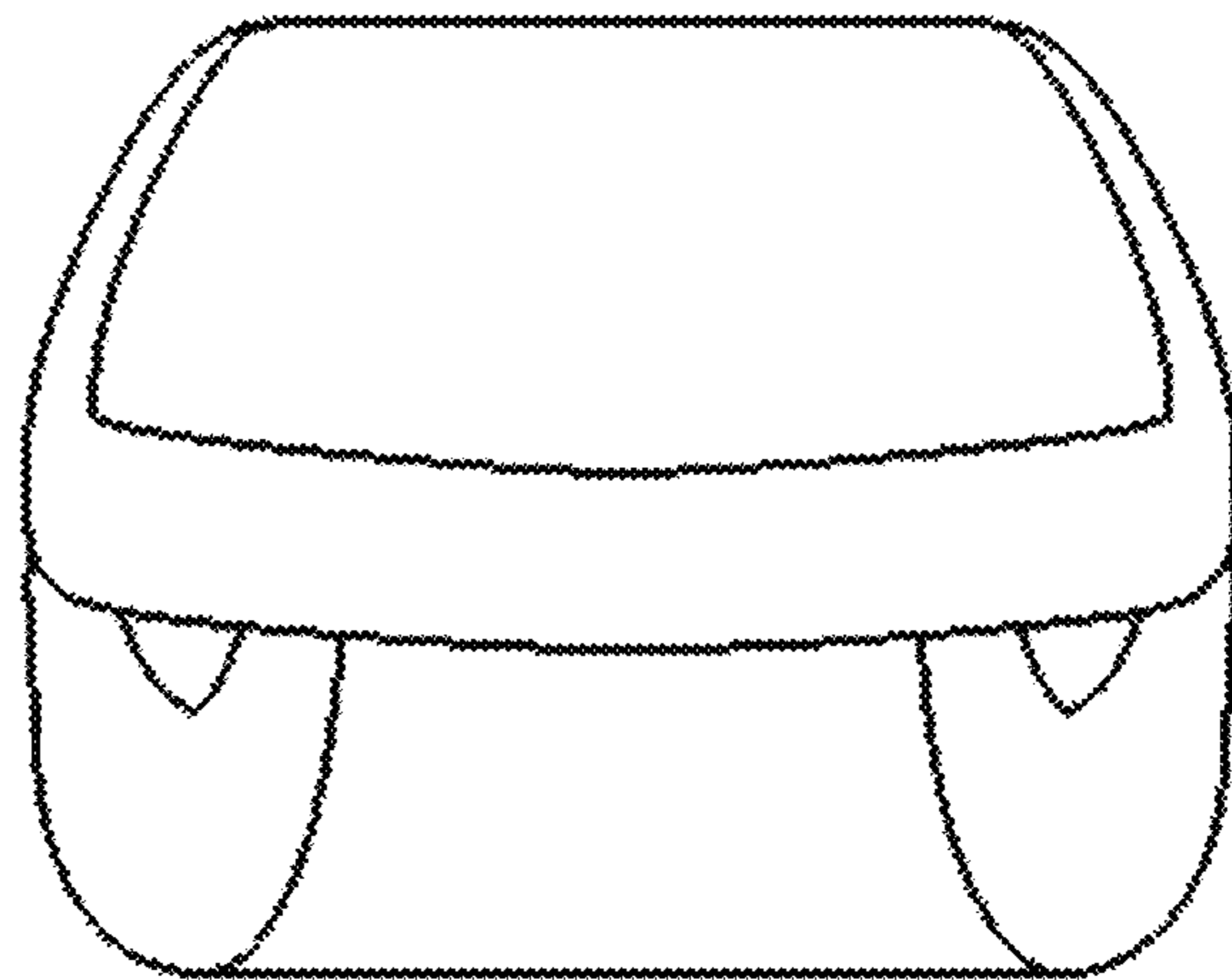

FIG. 6

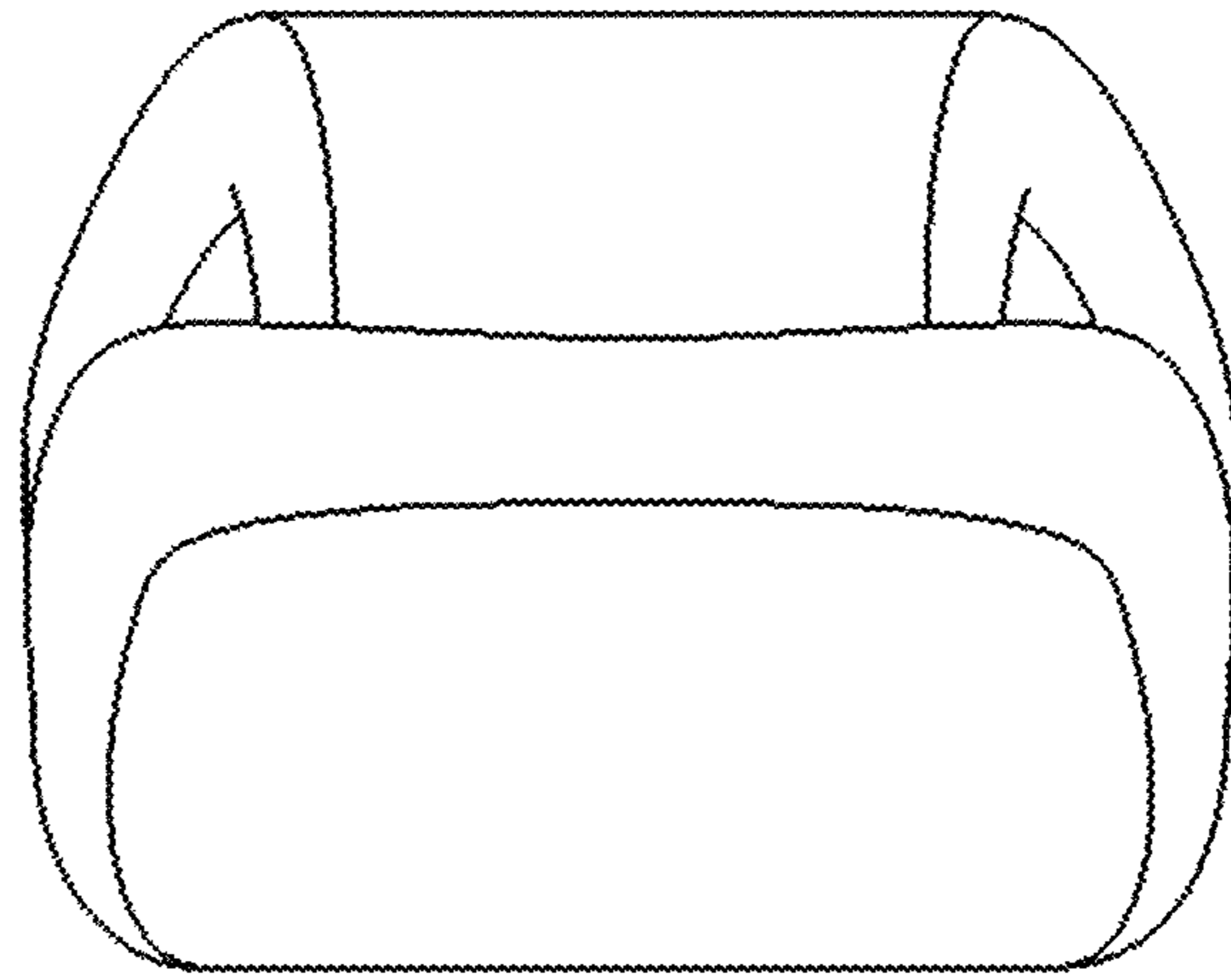

FIG. 7